

Philips Professional and Business Solution

22HFL3350D

26HFL3350D

32HFL3350D



EN SETUP MANUAL

PHILIPS

Table of contents

1 Important	4	7.12 Set auto scart.	21
1.1 Safety	4	7.13 Set USB break-in	21
1.2 Screen care.....	5	7.14 Select monitor out.	21
1.3 Recycling.....	5	7.15 Select blank current channel	22
2 Your TV	6	7.16 Save settings.....	22
2.1 Connection overview.....	6	8 Clone configuration	23
3 Remote control	8	8.1 From Cloning to TV.....	23
4 Get started	9	8.2 From TV to Cloning.....	23
4.1 Position the TV.....	9	9 Trouble shooting	24
4.2 Wall mount the TV.....	9	9.1 Communication issues.....	24
4.3 Connect the antenna cable	10	9.2 Picture issues	24
4.4 Connect the mains cord	10	9.3 Other issues	24
4.5 Insert the remote control batteries ..	10	10 Index	25
4.6 Prepare TV for digital services.....	11		
5 Remote control overview	13		
6 First time setup	15		
7 Setup BDS mode	16		
7.1 Access setup menu	16		
7.2 Switch on BDS mode	17		
7.3 Lock local keyboard.....	17		
7.4 Select remote control setting	17		
7.5 Select OSD display.....	18		
7.6 Set switch on volume.....	19		
7.7 Set maximum volume.....	19		
7.8 Select switch on channel	19		
7.9 Set power on status.....	19		
7.10 Set low power standby	20		
7.11 Select clock settings.....	20		

2008 © Koninklijke Philips Electronics N.V. All rights reserved.

Specifications are subject to change without notice. Trademarks are the property of Koninklijke Philips Electronics N.V. or their respective owners. Philips reserves the right to change products at any time without being obliged to adjust earlier supplies accordingly. The material in this manual is believed adequate for the intended use of the system. If the product, or its individual modules or procedures, are used for purposes other than those specified herein, confirmation of their validity and suitability must be obtained. Philips warrants that the material itself does not infringe any United States patents. No further warranty is expressed or implied.

Warranty

- Risk of injury, damage to TV or void of warranty! Never attempt to repair the TV yourself.
- Use the TV and accessories only as intended by the manufacturer.
- The caution sign printed on the back of the TV indicates risk of electric shock. Never remove the TV cover. Always contact Philips for service or repairs.



- Any operation expressly prohibited in this manual, or any adjustments and assembly procedures not recommended or authorised in this manual shall void the warranty.

Open source software

This television contains open source software.

Philips GBU Hospitality hereby offers to deliver or make available, upon request, for a charge no more than the cost of physically

performing source distribution, a complete machine-readable copy of the corresponding source code on a medium customarily used for software interchange.

To obtain the source code, write to:
Philips Singapore Pte Ltd
- Philips GBU Hospitality
Software Development Manager
620A Lorong 1 Toa Payoh
Singapore 319762

This offer is valid for a period of 3 years after the date of purchase of this product.

Pixel characteristics

This LCD product has a high number of color pixels. Although it has effective pixels of 99.999% or more, black dots or bright points of light (red, green or blue) may appear constantly on the screen. This is a structural property of the display (within common industry standards) and is not a malfunction.

Compliance with EMF

Koninklijke Philips Electronics N.V. manufactures and sells many products targeted at consumers, which, like any electronic apparatus, in general have the ability to emit and receive electromagnetic signals. One of Philips' leading Business Principles is to take all necessary health and safety measures for our products, to comply with all applicable legal requirements and to stay well within the EMF standards applicable at the time of producing the products. Philips is committed to develop, produce and market products that cause no adverse health effects. Philips confirms that if its products are handled properly for their intended use, they are safe to use according to scientific evidence available today. Philips plays an active role in the development of international EMF and safety standards, enabling Philips to anticipate further developments in standardisation for early integration in its products.

Mains fuse (UK only)

This TV is fitted with an approved moulded plug. Should it become necessary to replace the mains fuse, this must be replaced with a fuse of the same value as indicated on the plug (example 10A).

1. Remove fuse cover and fuse.
2. The replacement fuse must comply with BS 1362 and have the ASTA approval mark. If the fuse is lost, contact your dealer in order to verify the correct type.
3. Refit the fuse cover.

In order to maintain conformity to the EMC directive, the mains plug on this product must not be detached from the mains cord.

Copyright



VESA, FDMI and the VESA Mounting Compliant logo are trademarks of the Video Electronics Standards Association.

Windows Media is either a registered trademark or trademark of Microsoft Corporation in the United States and/or other countries.

® Kensington and Micro Saver are registered US trademarks of ACCO World Corporation with issued registrations and pending applications in other countries throughout the world. All other registered and unregistered trademarks are the property of their respective owners.

1 Important

Read and understand all instructions before you use the TV. If damage is caused by failure to follow instructions, the warranty does not apply.

1.1 Safety

- Risk of electric shock or fire!
 - Never expose the TV to rain or water. Never place liquid containers, such as vases, near the TV. If liquids are spilt on or into the TV, disconnect the TV from the power outlet immediately. Contact Philips to have the TV checked before use.
 - Never place the TV, remote control or batteries near naked flames or other heat sources, including direct sunlight.
 - To prevent the spread of fire, keep candles or other flames away from this product at all times.



- Never insert objects into the ventilation slots or other openings on the TV.
- When the TV is swivelled, ensure that no strain is exerted on the power cord. Strain on the power cord can loosen connections and cause arcing.
- Risk of short circuit or fire!
- Never expose the remote control or batteries to rain, water or excessive heat.
- Avoid force coming on the power plugs. Power plugs that are partly loosened can cause arcing or fire.
- Risk of injury or damage to the TV!

- Two people are required to lift and carry a TV that weighs more than 55 lbs.
- If you stand mount the TV, use only the supplied stand. Secure the stand to the TV tightly. Place the TV on a flat, level surface that can support the weight of the TV and stand.
- The TV must be mounted on the wall bracket designed for this TV, and on a wall that can safely hold the weight of the TV. Koninklijke Philips Electronics N.V. bears no responsibility for improper wall mounting that results in accident or injury.
- Risk of injury to children! Follow these precautions to prevent the TV from toppling over and causing injury to children:
 - Never place the TV on a surface covered by a cloth or other material that can be pulled away.
 - Ensure that no part of the TV hangs over the edge of the mounting surface.
 - Never place the TV on tall furniture (such as a bookcase) without anchoring both the furniture and TV to a suitable support (such as a concrete wall).
 - Educate children about the dangers of climbing on furniture to reach the TV.
- Risk of overheating! Never install the TV in a confined space such as a bookcase. Always leave a space of at least four inches around the TV for ventilation. Ensure curtains or other objects never cover the ventilation slots on the TV.
- Risk of injury, fire or power cord damage! Never place the TV or any objects on the power cord.
- Disconnect the TV from the power outlet and antenna before lightning storms. During lightning storms, never touch any part of the TV, power cord or antenna cable.

- Risk of hearing damage! Avoid using earphones or headphones at high volumes or for prolonged periods of time.
 - Never allow children to climb on or play with the TV.
 - Place the TV where it cannot be pushed, pulled over or knocked down.
 - If the TV is transported in temperatures below 5°C:
1. Remove the TV from the box.
 2. Wait until the TV temperature matches the room temperature.
 3. Install the TV.

1.2 Screen care

- Avoid stationary images as much as possible. Stationary images are images that remain on-screen for extended periods of time. Examples include: on-screen menus, teletext pages, black bars, stock market information, TV channel logos and time displays. If you must use stationary images, reduce screen contrast and brightness to avoid screen damage.
- Unplug the TV before cleaning.
- Clean the TV and frame with a soft, damp cloth. Never use substances such as alcohol, chemicals or household cleaners on the TV.
- Risk of damage to the TV screen! Never touch, push, rub or strike the screen with any object.
- To avoid deformations and colour fading, wipe off water drops as soon as possible.

1.3 Recycling

- This product is designed and manufactured with high quality materials and components, which can be recycled and reused.
- This product is designed and manufactured for material recycling. When you see the

crossed-out wheel bin symbol attached to a product, it means the product is covered by the European Directive 2002/96/EC:



- Never dispose this product with other household waste. Inform yourself or ask your dealer about local environmentally-safe recycling regulations. The correct disposal of your old product helps prevent potentially negative consequences on the environment and human health.
- The remote control supplied with this product operates on batteries covered by the European Directive 2006/66/EC and cannot be disposed with normal household waste. Inform yourself about the local regulations on the separate collection of batteries.

2 Your TV

2.1 Connection overview

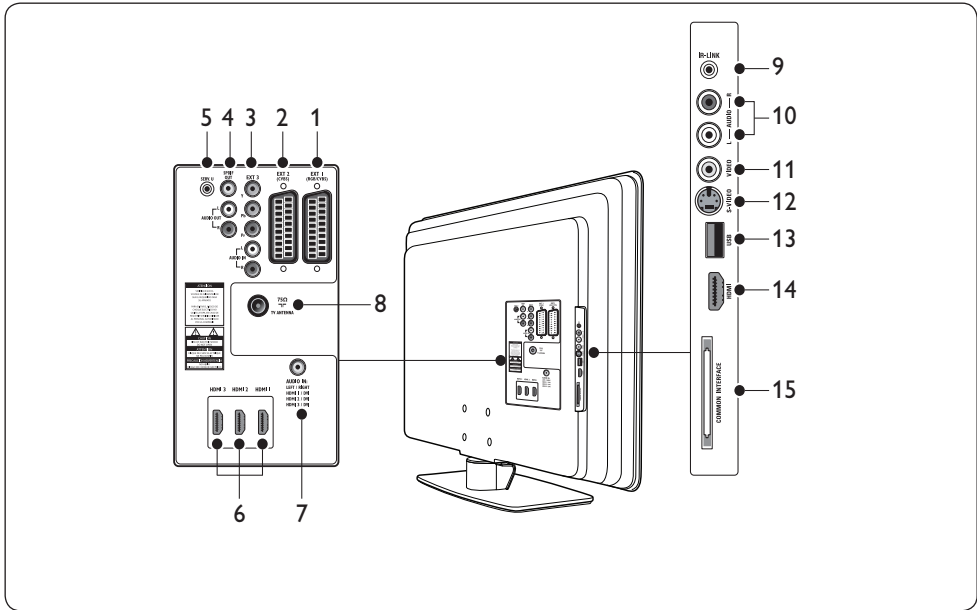

1. **EXT 1**

First SCART connector for DVD players, VCRs, digital receivers, game consoles and other SCART devices. Supports Audio L/R, CVBS in/out, RGB

2. **EXT 2**

Second SCART connector. Supports Audio L/R, CVBS in/out.

3. **EXT 3**

Component video (Y Pb Pr) and Audio L/R input connectors for DVD players.

4. **SPDIF OUT/AUDIO OUT**

Sound output connectors for home theatres or other audio systems.

5. **SERV. U**

Connector for service use (do not insert the headphones here)

6. **HDMI 1/2/3**

HDMI input connectors for Blu-ray disc players, digital receivers, game consoles and other high-definition devices.

7. **AUDIO IN**

Mini-jack connector for PC audio in (when connecting a PC via DVI-HDMI adaptor).

8. **TV ANTENNA**

9. **IR-LINK**

Connector for an IR-link-compliant device (e.g., set-top box).

10. **AUDIO L/R**

Audio L/R input connectors for composite and S-Video devices.

11. **VIDEO**

Video input connector for composite devices

12. **S-VIDEO**

S-Video input connector for S-Video devices.

13. USB

USB connector for storage devices.

14. HDMI

Additional HDMI connector for mobile high-definition devices.

15. COMMON INTERFACE

Slot for Conditional Access Modules.

**Note**

Refer to the user manuals for the respective devices for details of connection.

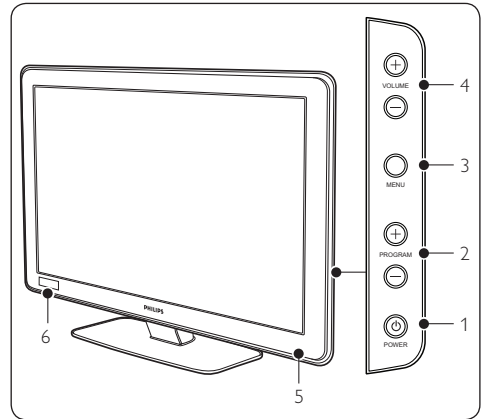
2.1.1 Side controls and indicators**1. POWER****2. PROGRAM +/-****3. MENU****4. VOLUME +/-**

5. Power indicator/remote control sensor

6. Clock

3 Remote control

For advanced information about the remote control, see *Chapter 5 Remote control overview*.

Guest mode remote control

For setup and configuration purposes.

Setup remote control

This remote control may be purchased separately for Institutional TV/Professional and Business Solutions features and SmartCard settings.

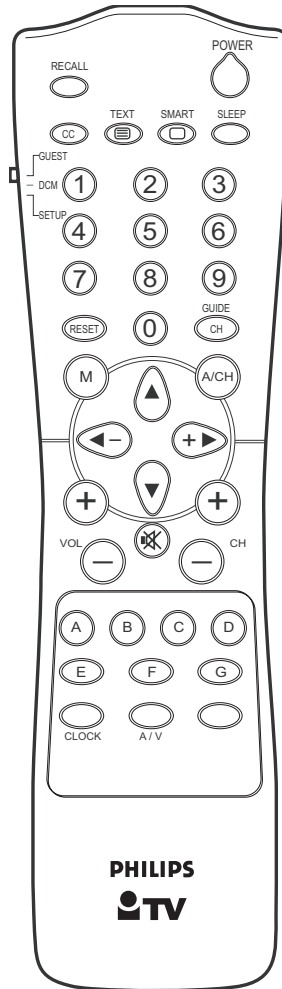
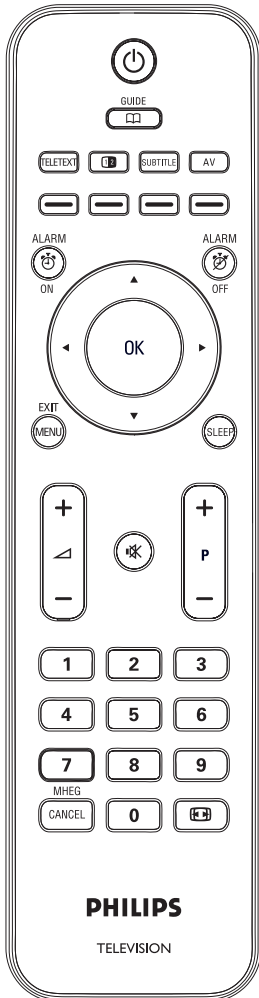

4 Get started

This section helps you position and install the TV.

4.1 Position the TV

In addition to reading and understanding the safety instructions in *Section 1.1*, consider the following before positioning your TV:

- The ideal viewing distance for watching TV is three times its screen size.
- Position the TV where light does not fall on the screen.
- Connect your devices before you position your TV.
- Your TV is equipped with a Kensington Security Slot at the back of the TV.

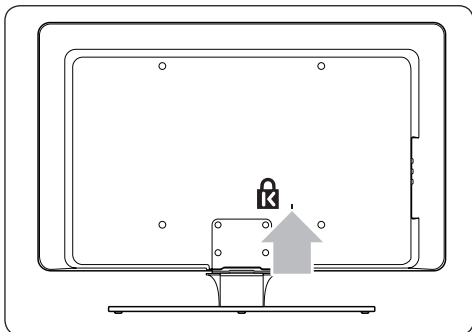

If connecting an anti-theft Kensington lock (not supplied), position the TV within reach of a permanent object (such as a table) that can be easily attached to the lock.

4.2 Wall mount the TV

⚠ WARNING

Wall mounting of the TV should only be performed by qualified installers. Koninklijke Philips Electronics N.V. bears no responsibility for improper mounting that results in accident or injury.

Step 1 Purchase a VESA-compatible wall bracket

Depending on the size of your TV screen, purchase one of the following wall brackets:

TV screen size (inches/cm)	VESA-compatible wall bracket type (mm)	Special instructions
22"/56cm	Adjustable 100 x 100	None
26"/66cm	Adjustable 100 x 200	None
32"/81cm	Adjustable 300 x 300	The VESA-compatible bracket must be adjusted to 200 x 300 before securing to the TV
42"/107cm or larger	Fixed 400 x 400	None

Step 2 Secure the VESA-compatible wall bracket to the TV

1. Locate the four mounting nuts at the back of the TV.

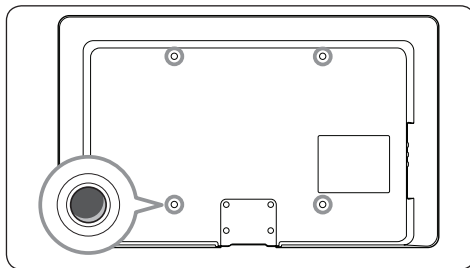

2. Continue with the instructions provided with your VESA-compatible wall bracket.

NOTE

When securing the VESA-compatible wall bracket to your TV, use M4 bolts for 26 inch models, M6 bolts for 32 inch models or M8 bolts for larger models (bolts not supplied).

4.3 Connect the antenna cable

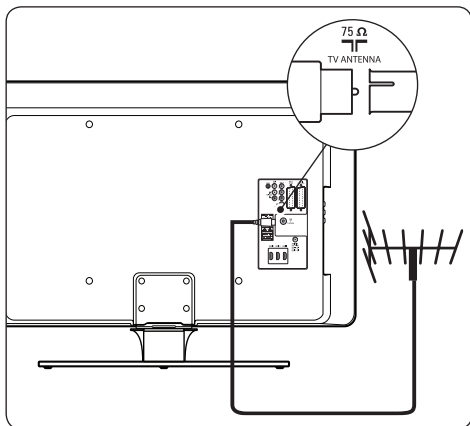

1. Locate the **TV ANTENNA** connector at the back of the TV.
2. Connect one end of an antenna cable (not supplied) to the **TV ANTENNA** connector. Use an adaptor if the antenna cable does not fit
3. Connect the other end of the antenna cable to your antenna outlet, ensuring that the cable is tightly secured at both ends.

4.4 Connect the mains cord

WARNING

Verify that your mains voltage corresponds with the voltage printed at the back of the TV. Do not insert the mains cord if the voltage is different.

To connect the mains cord

Note

The location of the mains connector varies according to TV model.

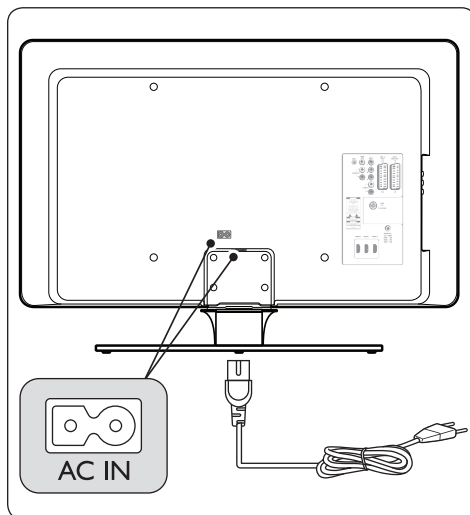

1. Locate the **AC IN** mains connector at the back or on the bottom of the TV.
2. Connect the mains cord to the **AC IN** mains connector.
3. Connect the mains cord to the mains, ensuring that the cord is tightly secured at both ends.

WARNING

Before you connect the TV to the power outlet, ensure that the power voltage matches the value printed under the cable cover.

To easily disconnect the TV from the power outlet, ensure that you have full access to the power cord at all times. When you disconnect the power cord, always pull the plug, never the cable.

4.5 Insert the remote control batteries

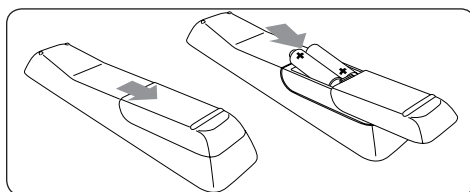

1. Slide the battery cover off the back of the remote control.
2. Insert the two supplied batteries (Size AAA, Type LR03). Be sure the + and - ends of the batteries line up with the markings inside the case.
3. Slide the cover back into position.

Note

Remove the batteries if not using the remote control for an extended period of time.

4.6 Prepare TV for digital services

Scrambled digital TV channels can be decoded with a Conditional Access Module, inserted with a smart card (CAM) provided by a digital TV service operator.

The CAM may enable several digital services, depending on the operator and services you choose (for example, pay TV). Contact your digital TV service operator for more information about services and terms.

4.6.1 Using the Conditional Access Module

WARNING

Switch off your TV before inserting a CAM. Be sure to follow the instructions described below. Wrong insertion of a CAM may damage both the CAM and your TV.

1. Following the directions printed on the CAM, gently insert the CAM into the Common Interface slot on the side of the TV.

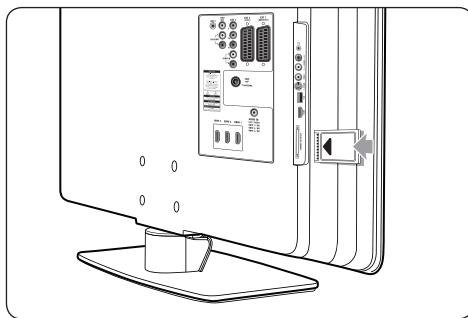

2. Push the CAM in as far as it will go.

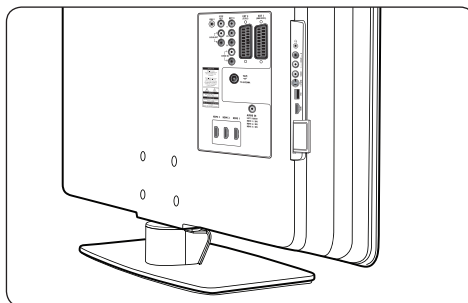

3. Switch on the TV and wait for the CAM to be activated. This may take several minutes.

Note

Do not remove the CAM from the slot. Removing the CAM will deactivate the digital services.

4.6.2 Access CAM services

1. Enter **Setup** menu.
2. Press **▼** to select **OSD display > Enable CI slot**.
3. Press **▲** to select **On**.

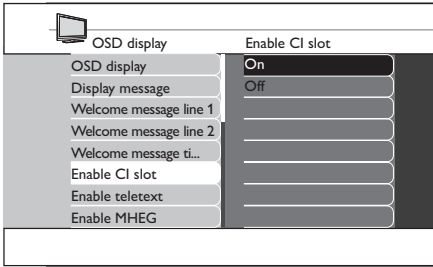

4. Press **MENU** or **M** to exit.

5 Remote control overview

This section provides a detailed overview of remote control features.

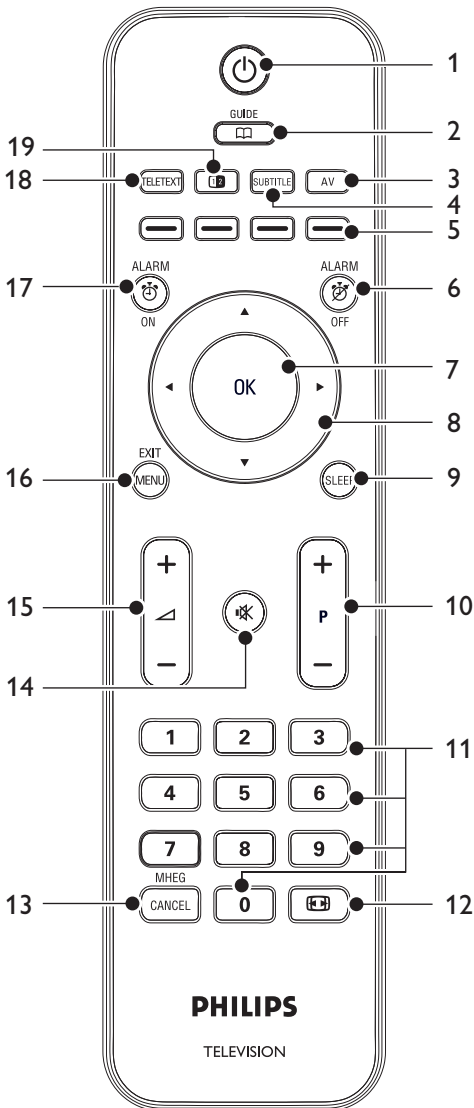

1. Switches the TV on from standby or back to standby.
2. **GUIDE**
Toggles the Electronic Programme Guide on or off. Only active with digital channels.
3. **AV**
Selects connected devices.
4. **SUBTITLE**
Activates or deactivates subtitles.
5. Colour keys
Selects tasks, teletext pages.
6. **ALARM OFF**
Deactivates the alarm function. Only for models with clock display.
7. **OK**
Activates a setting.
8. Navigation keys
Up ▲, Down ▼, Left ◀ and Right ▶ keys navigate the menu.
9. **SLEEP**
Sets sleep timer.
10. **P +/-**
Switches to the next or previous channel.
11. Number buttons
Selects a channel, page or setting.
12. Selects a picture format.
13. **MHEG CANCEL**
Cancels digital text or interactive services (UK only).
14. Mutes or restores sound.
15. Increases or decreases volume.
16. **MENU**
Toggles the menu on or off.
17. **ALARM ON**
Activates the alarm function. Only for models with clock display.

18. TELETEXT

Toggles teletext on or off

19. 

Spilts the current channel or source on the left of the screen. Teletext appears on the right.

6 First time setup

The first time the TV is switched on, a language selection menu appears.

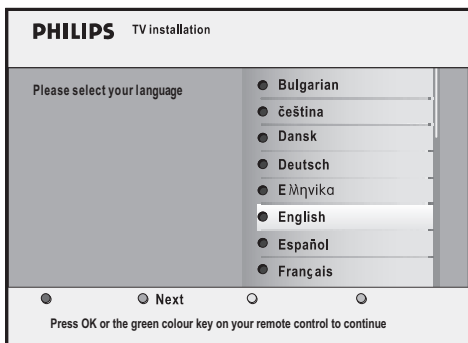

Select your language and follow the on-screen instructions to setup the TV.

Tip

You can skip the first time setup procedures by pressing **MENU** on the TV's control twice.

7 Setup BDS mode

The TV is designed to operate as BDS Hotel Mode, which offers the following benefits:

- Disable user menu. Guests cannot change channel, picture and sound settings.
- Select a switch on volume and channel. The TV will always start on the specified channel and volume level.
- Set a maximum volume.
- Setup Menu via the setup remote control or guest mode remote control.
- Blank out certain programmes.
- Disable the **VOLUME +/-**, **PROGRAM +/-** and **MENU** buttons on the TV.
- Suppress screen information.

ⓘ Note

For BDS mode settings to take effect, turn the TV set off, then on again.

ⓘ Tip

To enter menu level press ▶. To leave menu level press ◀.

7.1 Access setup menu

7.1.1 With guest mode remote control

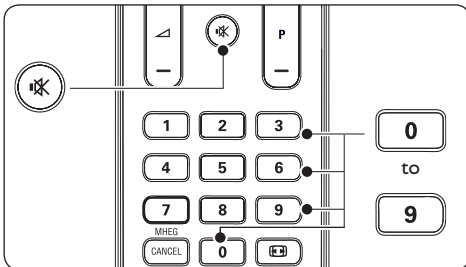

1. Switch on the TV and select a TV channel.
2. Press **3,1,9,7,5,3** and **M** on the remote control within 20 seconds to display the **Setup menu**.

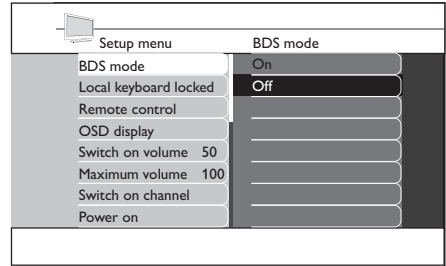

3. Select **Setup menu** > **Remote control** > **High security mode**.

• **On**

Allows access to the BDS Hotel Mode Setup Menu via the setup remote control only.

• **Off**

Allows access to the BDS Hotel Mode Setup Menu via the setup remote control or guest mode remote control.

7.1.2 With setup remote control

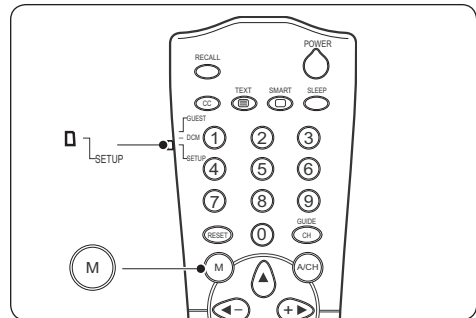

1. Switch on the TV and select a TV channel.
2. Slide the slider at the side of the remote control to **SETUP**.
3. Press **M** to display the **Setup menu**.

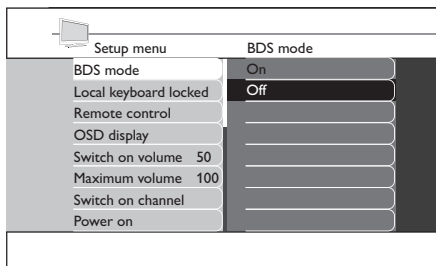

4. Select **Setup menu > Remote control > High security mode.**
 - **On**
Access the BDS Hotel Mode Setup Menu via the setup remote control only.
 - **Off**
Access the BDS Hotel Mode Setup Menu via the setup remote control or guest mode remote control.

7.2 Switch on BDS mode

1. Enter **Setup menu.**
2. Press **▶** to enter **BDS mode.**
3. Press **▲** to select **On.**
The user menus blocked and all settings of the BDS mode setup menu are in effect. To operate the TV as a normal consumer TV, select **Off.**

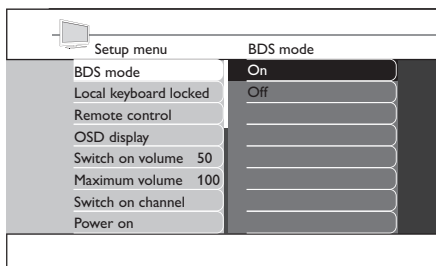

4. Press **▼** to select **Store - go right** and press **▶** to save setting.

7.3 Lock local keyboard

1. Enter **Setup menu.**
2. Press **▼** to select **Local keyboard locked.**
3. Press **▶** to enter **Local keyboard locked.**
4. Press **▲** to select **On.**
The **VOLUME +/-**, **PROGRAM +/-** and **MENU** buttons on the TV control are locked. To unlock, select **Off.**

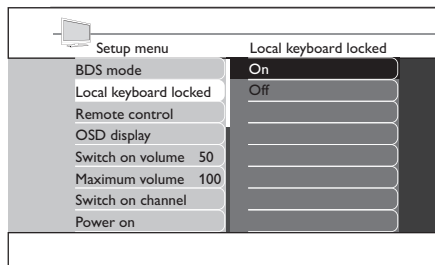

5. Press **▼** to select **Store - go right** and press **▶** to save setting.

7.4 Select remote control setting

1. Enter **Setup menu.**
2. Press **▼** to select **Remote control.**

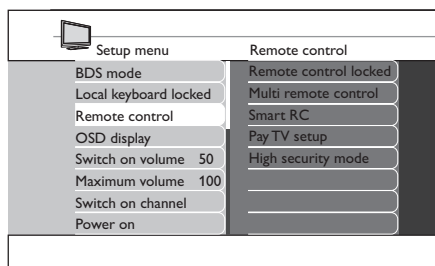

3. Press **▶** to enter **Remote control.**
4. Press **▲** or **▼** to select a setting.
5. Press **▶** to enter.
 - **Remote control locked**
 - **On**
Locks standard remote control buttons

- **Off**
Unlock remote control buttons.
- **Multi remote control**
 - **Off**
Disable multi remote control function.
 - **Blue**
Select to use the blue guest remote control.
 - **Red**
Select to use the red guest remote control.
 - **Green**
Select to use the green guest remote control.
 - **Yellow**
Select to use the yellow guest remote control.
- **Smart RC**
 - **On**
Select to use the smart remote control.
 - **Off**
Disable the use the smart remote control.
- **Pay TV setup**
Select **R0**, **R1** or **R2** setting for the various pay TV channels.
- **High security mode**
 - **On**
Access the BDS Hotel Mode Setup Menu via the setup remote control only.
 - **Off**
Access the BDS Hotel Mode Setup Menu via the setup remote control or guest mode remote control.

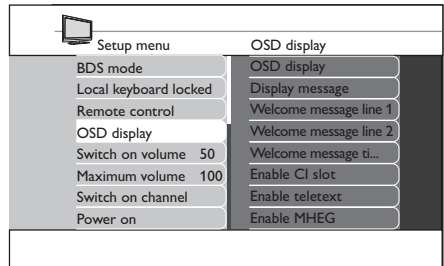

3. Press **▶** to enter **OSD display**.
4. Press **▲** or **▼** to select a setting.
5. Press **▶** to enter.
 - **OSD display**
 - **On**
Display normal screen information.
 - **Off**
Suppress screen information.
 - **Display message**
 - **On**
Display the welcome message after the TV set is turned on.
 - **Off**
Disable the welcome message.
 - **Welcome message line 1/2**
Press **▲** or **▼** to create the first or second line of the welcome message. You can create up to a maximum of 20 alphanumeric characters for each line. Press the **red** button to cancel, **green** button to exit, **yellow** button to clear all the characters or **blue** button to delete any character.
 - **Welcome message timeout**
Select the time out period for the welcome message.
 - **Enable CI slot**
Select **On** to access CAM services.
 - **Enable teletext**
Select **On** to access teletext.

7.5 Select OSD display

1. Enter **Setup menu**.
2. Press **▼** to select **OSD display**.

- **Enable MHEG**
Select **On** to access MHEG.
- **Enable EPG**
Select **On** to access EPG.
- **Enable Subtitles**
Select **On** to display subtitles.

7.6 Set switch on volume

When the user switches the TV on, it will play at the specified volume level set.

1. Enter **Setup menu**.
2. Press **▼** to select **Switch on volume**.
3. Press **▶** to enter **Switch on volume**.

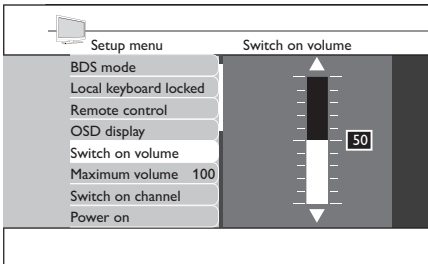

4. Press **▲** or **▼** to select the desired volume level.
5. Press **▼** to select **Store - go right** and press **▶** to save setting.

7.7 Set maximum volume

The TV volume will not exceed the selected volume level set.

1. Enter **Setup menu**.
2. Press **▼** to select **Maximum volume**.
3. Press **▶** to enter **Maximum volume**.

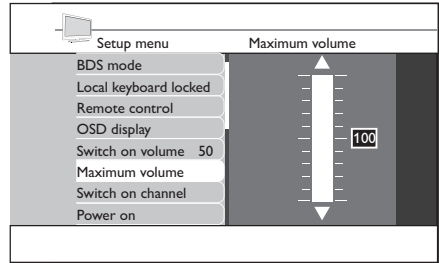

4. Press **▲** or **▼** to select the desired volume level.
5. Press **▼** to select **Store - go right** and press **▶** to save setting.

7.8 Select switch on channel

When the user switches the TV on, it will tune to the specified channel.

1. Enter **Setup menu**.
2. Press **▼** to select **Switch on channel**.

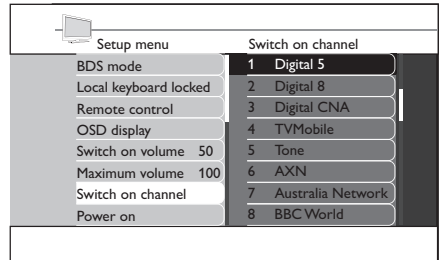

3. Press **▶** to enter **Switch on channel**.
4. Press **▲** or **▼** to select the desired channel.
5. Press **▼** to select **Store - go right** and press **▶** to save setting.

7.9 Set power on status

When the user switches the TV on, it will enter the specified mode of operation selected.

1. Enter **Setup menu**.
2. Press **▼** to select **Power on**.

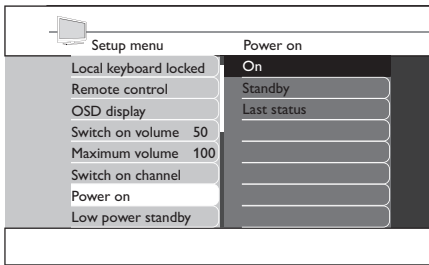

3. Press ► to enter **Power on**.
4. Press ▲ or ▼ to select the desired status.

- **On**
The TV will always turn on after the mains power is connected.
- **Standby**
The TV will always turn to standby after the mains power is connected.
- **Last status**
The TV will always turn on the last power status after the mains power is connected.

5. Press ▼ to select **Store** - go right and press ► to save setting.

7.10 Set low power standby

Set the different power saving option when the TV is in standby mode.

1. Enter **Setup menu**.
2. Press ▼ to select **Low power standby**.

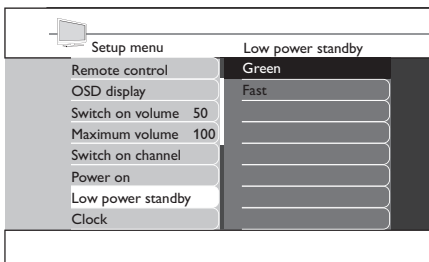

3. Press ► to enter **Low power standby**.
4. Press ▲ or ▼ to select the desired status.

- **Green**
The TV will enter a low standby mode to achieve minimum power consumption.
 - **Fast**
The TV will enter a semi-standby mode to achieve fast power up.
5. Press ▼ to select **Store** - go right and press ► to save setting.

7.11 Select clock settings

Select and configure the clock settings.

1. Enter **Setup menu**.
2. Press ▼ to select **Clock**.

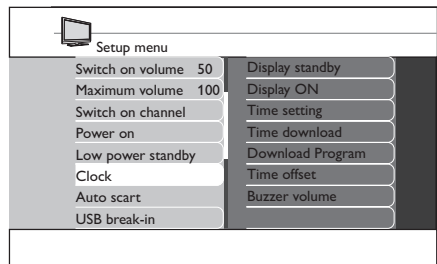

3. Press ► to enter **Clock**.
4. Press ▲ or ▼ to select the setting that you want to configure.
5. Press ► to select the settings.
6. Press ▲ or ▼ to select options or make adjustment.

- **Display standby**
Set the brightness level of the clock display when the TV is in standby mode.
- **Display ON**
Set the brightness level of the clock display when the TV is switched on.
- **Time setting**
Set the time of the clock display manually.

ⓘ Note

This option is only available if **Time download** is **OFF**.

- **Time download**
Set the time of the clock display automatically via Teletext. The clock will be automatically synchronised to the correct time.
 - **Download Program**
Select the time from the teletext transmission of a channel. Make this download program the same as the startup channel.
 - **Time offset**
Set the time difference between the time received from Teletext to the current time at your location.
 - **Buzzer volume**
Set the volume of the alarm buzzer.
7. Press ▼ to select **Store - go right** and press ► to save setting.

7.12 Set auto scart

Set the TV to switch to the source where scart signal is detected.

1. Enter **Setup menu**.
2. Press ▼ to select **Auto scart**.

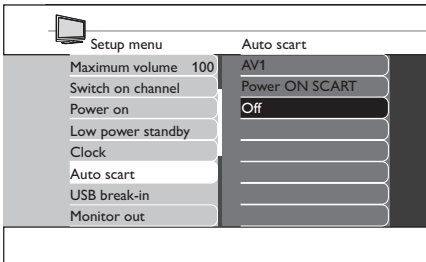

3. Press ► to enter **Auto scart**.
 4. Press ▲ or ▼ to select the desired option.
- **AV1**
Select to switch TV automatically to AV1 when scart cable is connected to the AV1 connector.
 - **Power ON SCART**
Select to switch the TV on from standby

mode when a scart signal is detected or when no scart signal is detected the TV will go to standby mode.

- **Off**
Switch off this feature.
5. Press ▼ to select **Store - go right** and press ► to save setting.

7.13 Set USB break-in

Set the TV to automatically detect USB devices.

1. Enter **Setup menu**.
2. Press ▼ to select **USB break-in**.

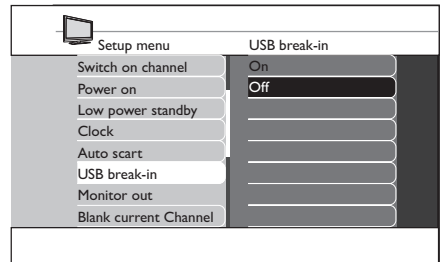

3. Press ► to enter **USB break-in**.
4. Press ▲ or ▼ to select the desired option.

- **On**
Enable plug and play auto detection of USB devices.
 - **Off**
Disable plug and play auto detection of USB devices.
5. Press ▼ to select **Store - go right** and press ► to save setting.

7.14 Select monitor out

Select to output audio and video from TV via relevant AV connectors.

1. Enter **Setup menu**.
2. Press ▼ to select **Monitor out**.

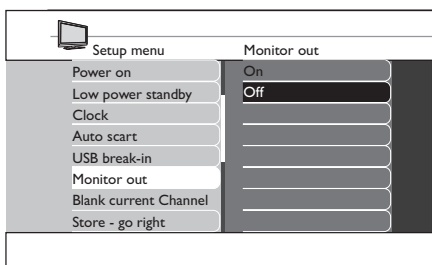

3. Press ► to enter **Monitor out**.
4. Press ▲ or ▼ to switch **ON** or **OFF** this feature.
5. Press ▼ to select **Store - go right** and press ► to save setting.

1. Select your desired options or adjustments.
2. Press ▼ to select **Store - go right**.

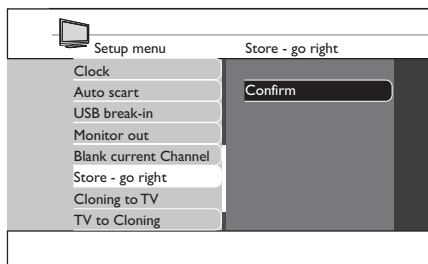

3. Press ► to enter **Store - go right**.
4. Press ► to confirm saving.

7.15 Select blank current channel

Disable only the video display on screen. Used on channels for radio transmission, music etc.

1. Enter **Setup menu**.
2. Press ▼ to select **Blank current Channel**.

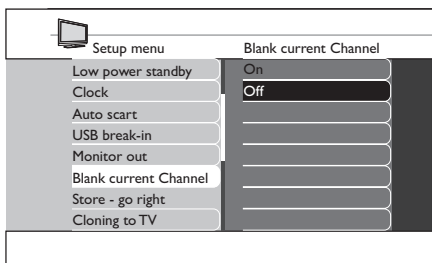

3. Press ► to enter **Blank current Channel**.
4. Press ▲ or ▼ to switch **ON** or **OFF** this feature.
5. Press ▼ to select **Store - go right** and press ► to save setting.



Tip

You can save once after you have selected all the settings but before you exit the menu.

7.16 Save settings

Select this option to save the settings.

8 Clone configuration

8.1 From Cloning to TV

Copy TV configuration data from a USB stick to TV.

1. Insert the USB stick to the USB connector at the side of the TV.
2. Enter **Setup menu**.
3. Press ▼ to select **Cloning to TV**.
4. Press ► to enter **Cloning to TV**.
5. Press ► to load data to the TV.
During this process, the cloning files.

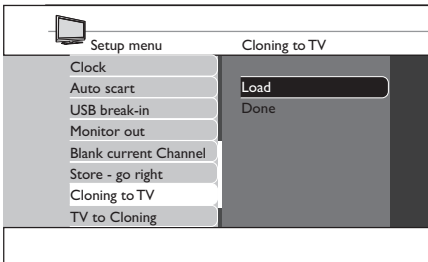

Note

- During the process of copying, do not remove the USB stick.
 - All remote control command and control buttons on the TV are disabled.
6. Switch off and then on to reset the TV after cloning.

8.2 From TV to Cloning

Copy TV configuration data from TV to USB stick.

1. Enter **Setup menu**.
2. Press ▼ to select **TV to Cloning**.
3. Press ► to enter **TV to Cloning**.
4. Press ► to load data to the USB stick.

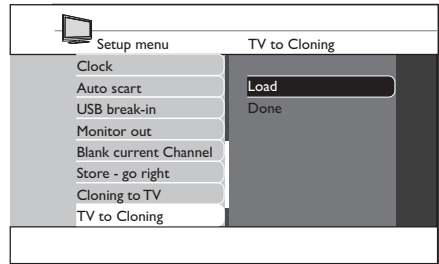

Note

- During the process of copying, do not remove the USB stick.
 - All remote control command and control buttons on the TV are disabled.
5. Switch off and then on to reset the TV after cloning.

9 Trouble shooting

This section describes commonly-encountered issues and accompanying solutions.

9.1 Communication issues

The TV does not communicate with external interactive terminal:

- Check that the card slot is enabled. See *Section 4.6.2 Access CAM services* for details.

9.2 Picture issues

No picture

- Check that the **Blank current channel** feature is not switched on. See *Section 7.16 Select blank current channel* for details.

9.3 Other issues

The character 'F' appears on the TV screen.

This means that the TV is currently in factory mode.

- Press and hold the **MENU** button at the side of the TV for a few seconds. This will reset the TV to normal operation.

No respond from TV when using guest mode remote control.

This means that high security mode has been set to **On**.

- Select **Setup menu > Remote control**. Set **High security mode** to **Off**.

BDS mode not working.

- Check that the mode is not switched on. Switch the TV off and on to reset.

Remote control does not work

- Check that the batteries are not faulty.

- Check that the remote control is not locked. See *Section 7.4 Select remote control setting* for details.

10 Index

A

AUDIO

IN 6

L/R 6

Auto scart 21

B

BDS mode

setup 16

C

Channel

install manually 19

switch on 19

Clock 7

display on 20

display standby 20

settings 20

time download 21

time offset 21

time setting 20

Clone configuration

from Cloning to TV 23

From Cloning to TV 23

Common Interface 7

Conditional Access Module 11

Connect 10

antenna cable 10

mains cord 10

E

EMF 2

EXT 1 6

EXT 2 6

EXT 3 6

G

Get started 9

H

HDMI 7

HDMI 1 6

HDMI 2 6

HDMI 3 6

I

Important information 4

K

Kensington lock 9

M

MHEG 13

Mute 13

O

OSD

display 18

P

Pay TV

setup 18

Power

indicator 7

low standby 20

on status 19

R

Recycling 5

Remote control 8

basic use 8

batteries 10

locked 17

multi 18

overview 13

sensor 7

setting 17

smart 18

S

Safety 4

SCART 6

Screen care 5

SERV.U 6

Setup

menu 16

with guest mode remote control 16

with setup remote control 16

Side

Controls 7

SPDIF OUT 6

S-VIDEO 6

T

Trouble shooting 24

TV 9

antenna 6

connection overview 6

position 9

prepare for digital services 11

setup 15

side controls 7

stand 9

U

USB 7

V

VESA 3

compatible wall bracket 9

VIDEO 6

Volume

buzzer 21

maximum 19

switch on 19

W

Warranty 2

