



Remote Start Keyless Entry RK20 Installation Guide

This product is intended for installation by a professional installer only! Attempts to install this product by a person other than a trained professional may result in severe damage to a vehicle's electrical system and components.

Bitwriter®, Code Hopping™, Doubleguard®, ESP2™, Fail-Safe®, Ghost Switch™, Learn Routine™, Nite-Lite®, Nuisance Prevention® Circuitry, Revenger®, Silent Mode™, Soft Chirp®, Stinger®, Valet®, Vehicle Recovery System®, VRS®, and Warn Away® are all Trademarks or Registered Trademarks of Directed Electronics.



Contents

Warning! Safety first	5
What is included.....	7
Installation points to remember.....	8
Intelli-Tach.....	8
D2D.....	8
Before beginning the installation.....	9
After the installation.....	9
Finding the wires you need	10
Obtaining constant 12V.....	10
Starter wire.....	10
12V switched ignition wire.....	12
Accessory wire.....	12
(+) Parking light wire.....	12
Tachometer wire.....	13
Making your wiring connections	15
Primary harness (H1).....	16
4-pin satellite harness.....	16
Heavy gauge relay harness.....	17
Door lock harness, 3-pin connector.....	17
Wire connection guides.....	18
Primary harness (H1), 9-pin connector.....	18
Remote start harness, (H2) 5-pin connector.....	21
Heavy gauge relay 5-pin connector.....	24
Program switch - 2-pin connector.....	25
Neutral safety switch interface.....	26
Bypassing GM vehicle anti-theft systems (VATS).....	29
1995 and newer, VATS (immobilizers).....	30
Optional anti-grind relay.....	32
Tachometer settings.....	33
Intelli-Tach.....	33
Tach learning.....	34
Programming jumpers.....	35
Light flash (+) / (-) polarity.....	35
Tach threshold On/Off.....	35
Transmitter/receiver Learn Routine™.....	36
Transmitter configurations.....	39
Standard configuration.....	39
Operating settings learn routine.....	40
Feature menus.....	42
Menu 1.....	42
Menu 2.....	42

Feature descriptions.....	43
Menu 1	43
Menu 2	45
Shutdown diagnostics.....	47
Rear defogger control.....	48
Timer mode	49
Safety check.....	50
Troubleshooting	51
Wiring quick reference guide	54

Warning! Safety first

The following safety warnings must be observed at all times:

- Due to the complexity of this system, installation of this product must only be performed by an authorized Ungo dealer.
- When properly installed, this system can start the vehicle via a command signal from the remote control. Therefore, never operate the system in an area that does not have adequate ventilation.

The following precautions are the sole responsibility of the user; however, authorized Ungo dealers should:

- Never operate the system in an enclosed or partially enclosed area without ventilation (such as a garage).
- When parking in an enclosed or partially enclosed area or when having the vehicle serviced, the remote start system must be disabled using the installed toggle switch. It is the user's sole responsibility to properly handle and keep out of reach from children all remote controls to assure that the system does not unintentionally remote start the vehicle.

USER MUST INSTALL A CARBON MONOXIDE DETECTOR IN OR ABOUT THE LIVING AREA ADJACENT TO THE VEHICLE. ALL DOORS LEADING FROM ADJACENT LIVING AREAS TO THE ENCLOSED OR PARTIALLY ENCLOSED VEHICLE STORAGE AREA MUST REMAIN CLOSED AT ALL TIMES.

Use of this product in a manner contrary to its intended mode of operation may result in property damage, personal injury, or death. Except when performing the Safety Check outlined in this installation guide, (1) Never remotely start the vehicle with the vehicle in gear, and (2) Never remotely start the vehicle with the keys in the ignition. The user will be responsible for having the neutral safety feature of the vehicle periodically checked, wherein the vehicle must not remotely start while the car is in gear. This testing should be performed by an authorized Ungo dealer in accordance with the Safety Check outlined in this product installation guide. If the vehicle starts in gear, cease remote start operation immediately and consult with the user to fix the problem immediately

After the remote start module has been installed, test the remote start module in accordance with the Safety Check outlined in this installation guide. If the vehicle starts when performing the Neutral Safety Shutdown Circuit test, the remote start unit has not been properly installed. The remote start module must be removed or properly reinstalled so that the vehicle does not start in gear. All installations must be performed by an authorized Ungo dealer.

OPERATION OF THE REMOTE START MODULE IF THE VEHICLE STARTS IN GEAR IS CONTRARY TO ITS INTENDED MODE OF OPERATION. OPERATING THE REMOTE START SYSTEM UNDER THESE CONDITIONS MAY RESULT IN PROPERTY DAMAGE OR PERSONAL INJURY. IMMEDIATELY CEASE THE USE OF THE UNIT AND REPAIR OR DISCONNECT THE INSTALLED REMOTE START MODULE. CLARION WILL NOT BE HELD RESPONSIBLE OR PAY FOR INSTALLATION OR REINSTALLATION COSTS.

What is included

- The control module
- (2) 4-button transmitters
- A plug-in program switch
- A hood pinswitch
- A toggle override switch
- HX+ antenna receiver

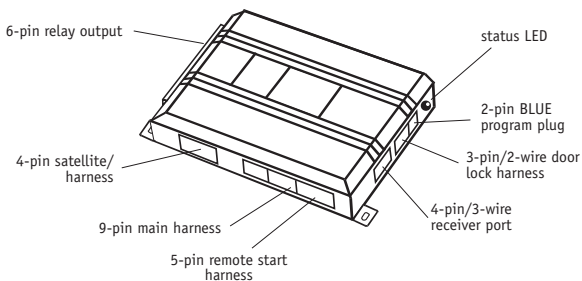

HX Antenna receiver

Installation points to remember

This product is designed for fuel-injected, automatic transmission vehicles only. Installing it in a standard transmission vehicle is dangerous and is contrary to its intended use.

► Intelli-Tach

Intelli-Tach is a new feature for Ungo this year. It is the default RPM-sensing method for the new remote start system.

Intelli-Tach gives the installer the performance of a hard wired tach wire, with the convenience of voltage sensing. It is far superior to any voltage-sense feature you've tried before.

Intelli-Tach monitors the cranking voltage of the vehicle using a very fast micro controller and an analog-to-digital converter. The microprocessor "saves" the base voltage as a reference. When Intelli-Tach "sees" the slightest uptick in voltage, indicating that the alternator is charging the battery, the starter motor shuts off instantly.

► D2D

The system has the ability to interface with an XK module through the D2D port. The advantage to using a D2D interface is that there is less wiring involved in the installation. Check the XK module installation guide to determine which wires are not needed, and which options are available.

► Before beginning the installation

- Please read this entire installation guide before beginning the installation. The installation of this remote start system requires interfacing with many of the vehicle's systems. Many new vehicles use low-voltage or multiplexed systems that can be damaged by low resistance testing devices, such as test lights and logic probes (computer safe test lights). Test all circuits with a high quality digital multi-meter before making connections.
- Do not disconnect the battery if the vehicle has an anti-theft-coded radio. If equipped with an air bag, avoid disconnecting the battery if possible. Many airbag systems display a diagnostic code through the warning lights after the lights lose power. Disconnecting the battery causes the anti-theft code to be erased, which can then require a trip to the dealer.
- If using an external LED or Program Switch, check with the customer about where to locate the switch.
- To avoid accidental battery drainage; turn off the interior lights or remove the dome light fuse.
- Roll down a window to avoid being locked out of the car.

► After the installation

- Test all functions. The Using Your System section of the Owner's Guide is very helpful when testing.
- Review and complete the Safety Check section of this guide prior to the vehicle reassembly.

Finding the wires you need

Important: Do not use a 12V test light or logic probe (computer safe test light) to locate these wires. All testing described in this manual assumes the use of a digital multimeter.

► Obtaining constant 12V

We recommend two possible sources for 12V constant: The (+) terminal of the battery, or the constant 12V supply to the ignition switch. Always install a fuse within 12 inches of this connection. If the fuse will also be powering other circuits, such as door locks, a power window module, or a Nite-Lite® headlight control system, fuse accordingly.

Important: Do not remove the fuse holder on the red wire. It ensures that the control module has its own fuse, of the proper value, regardless of how many accessories are added to the main power feed. .

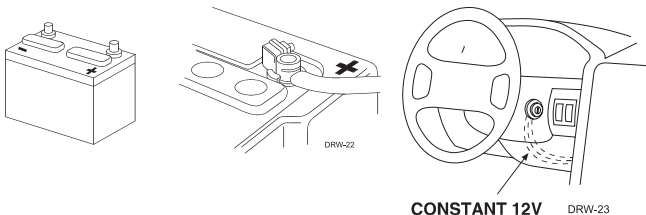

► Starter wire

The starter wire provides 12V directly to the starter or to a relay controlling starter. In some vehicles, it is necessary to power a cold start circuit. A cold start circuit will test exactly like a starter circuit, but it does not control the starter. Instead, the cold start circuit is used to prime the fuel injection system for starting when the vehicle is cold.

How to find the starter wire with your multimeter:

1. Set to DCV or DC voltage (12V or 20V is fine).
2. Attach the (-) probe of the meter to chassis ground.
3. Probe the wire you suspect of being the starter wire. The steering column is an excellent place to find this wire. Remember you do not need to interrupt the starter, unless an optional anti-grind/starter disable relay is going to be installed. Hiding your starter kill relay and connections is always recommended.
4. Turn the ignition key switch to the start position. Make sure the car is not in gear! If your meter reads (+)12V, go to the next step. If it doesn't, probe another wire.
5. If installing an optional anti-grind/starter disable relay, cut the wire you suspect of being the starter wire.
6. Attempt to start the car. If the starter engages, reconnect it and go back to Step 3. If the starter does not turn over, you have the right wire.
7. Connect the key side of the starter wire to terminal 87a of the optional relay.
8. Connect the violet wire along with the start motor side of the wire to terminal 30 on the relay.
9. Connect a wire from the 12V switched ignition wire to terminal 86 on the relay. (See "finding the 12V switched ignition wire" for assistance in locating the wire)
10. Connect the orange wire (H1/5) from the 9-pin harness to terminal 85 of the relay.

► 12V switched ignition wire

The ignition wire is powered when the key is in the run or start position. This is because the ignition wire powers the ignition system (spark plugs, coil) as well as the fuel delivery system (fuel pump, fuel injection computer). Accessory wires lose power when the key is in the start position to make more current available to the starter motor.

How to find (+)12V ignition with your multimeter:

1. Set to DCV or DC voltage (12V or 20V is fine).
2. Attach the (-) probe of the meter to chassis ground.
3. Probe the wire you suspect of being the ignition wire. The steering column harness or ignition switch harness is an excellent place to find this wire.
4. Turn the ignition key switch to the run position. If your meter reads (+)12V, go to the next step. If it does not read (+)12V, probe another wire.
5. Now turn the key to the start position. The meter display should stay steady, not dropping by more than a few tenths of a volt. If it drops close to or all the way to zero, go back to Step 3. If it stays steady at (+)12V, you have found an ignition wire.

► Accessory wire

An accessory wire will show (+)12V when the key is in the accessory and run positions. It will not show (+)12V during the cranking cycle. There will often be more than one accessory wire in the ignition harness. The correct accessory wire will power the vehicle's climate control system. Some vehicles may have separate wires for the blower motor and the air conditioning compressor. In such cases, it will be necessary to add a relay to power the second accessory wire.

► (+) Parking light wire

Most vehicles use a (+) parking light circuit. The (+) parking light wire is often found near the light switch. In many vehicles the light switch is built into the turn signal lever; in these vehicles the parking light wire can be found in the steering column. The same wire can often be accessed in the kick panel or running board.

Note: Many Toyotas and other Asian vehicles, send a (-) signal from the switch to a relay. The relay then sends (+)12V to the bulbs. Whenever you have difficulty finding a (+) parking light wire near the switch, simply test the wires at any switch or control panel that is lit by the instrument panel lighting. Remember, you need a (+) parking light wire that does not vary with the dimmer setting.

How to find a (+) parking light flash wire with your multimeter:

1. Set to DCV or DC voltage (12V or 20V is fine).
2. Attach the (-) probe of the meter to chassis ground.
3. Probe the wire you suspect of being the parking light wire. Usually, the area near the headlight/parking light switch is an excellent area to start, as is the kick panel.
4. Turn on the parking lights. If your meter shows (+)12V, turn off the parking lights and make sure it goes back to zero.
5. If it does return to zero, turn the parking lights back on and, using the dash light dimmer control, turn the brightness of the dash lights up and down. If the meter changes more than a volt when using the dimmer, look for another wire. If it stays relatively close to (+)12V, you have found your parking light wire

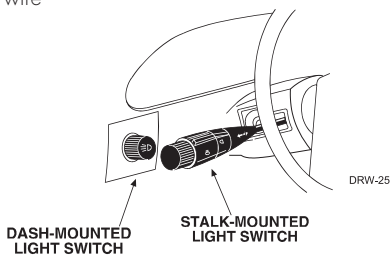

Note: Vehicles that use a (-) signal from the switch to the factory relay may be interfaced directly. (See H1/5 WHITE wire of Primary Harness (H1) Wire Connection Guide section.)

► Tachometer wire

To test for a tachometer wire, a multimeter capable of testing AC voltage must

be used. The tachometer wire will show between 1V and 6V AC. In multi-coil ignition systems, the system can learn individual coil wires. Individual coil wires in a multi-coil ignition system will register lower amounts of AC voltage. Also, if necessary, the system can use a fuel injector control wire for engine speed sensing. Common locations for a tachometer wire are the ignition coil itself, the back of the gauges, engine computers, and automatic transmission computers.

Important! Do not test tachometer wires using a test light or logic probe. The vehicle will be damaged.

1. How to find a tachometer wire with your multimeter:
2. Set to ACV or AC voltage (12V or 20V is fine).
3. Attach the (-) probe of the meter to chassis ground.
4. Start and run the vehicle.
5. Probe the wire you suspect of being the tachometer wire with the red probe of the meter.
6. If this is the correct wire the meter will read between 1V and 6V.

Making your wiring connections

Before making your connections, plan how your wires will be routed through the vehicle. For instance, the red 12V constant input and the remote start ignition wires are often routed together to the ignition switch harness. In order to keep the wiring neat and make it harder to find, you may wish to wrap these wires together in electrical tape or conceal them in tubing similar to what the manufacturer used.

There are two acceptable ways of making a wire connection - solder connections and crimp connectors. When properly performed, either type of connection is reliable and trouble-free. Regardless of whether you solder your connections or you use mechanical type crimp-on connections, ensure that all connections are mechanically sound and that they are insulated, especially when connecting data lines in the vehicle.

Cheap electrical tape, especially when poorly applied, is not a reliable insulator. It often falls off in hot weather. Use good quality electrical tape or heat shrink.

- Never twist-and-tape the wires together without soldering.
- Never use "fuse taps", as they can damage fuse box terminals.

If you use tapping connectors such as T-Taps (not to be confused with Scotch-Locks), avoid using them in higher-current applications (constant 12V, ground, etc.) These connectors are inferior in quality and should be avoided.

► Primary harness (H1)

H1/1	LIGHT GREEN/ BLACK	FACTORY ALARM DISARM
H1/2	GREEN/WHITE	FACTORY ALARM DISARM
H1/3	YELLOW	(+) IGNITION OUT (TO ALARM)
H1/4	WHITE/BLUE	(-) ACTIVATION INPUT
H1/5	ORANGE	(-) GROUND-WHEN-LOCKED
H1/6	BROWN	(-) HORN OUTPUT
H1/7	RED/WHITE	CHANNEL 2 (VALIDITY ONLY)
H1/8	BLACK	GROUND
H1/9	WHITE	(+/-) LIGHT FLASH

► Remote start harness, (H2) 5-pin connector

H3/1	BLACK/WHITE	(-) NEUTRAL SAFETY SWITCH INPUT
H3/2	VIOLET/WHITE	TACHOMETER INPUT WIRE
H3/3	BROWN	(+) BRAKE SHUTDOWN INPUT WIRE
H3/4	GRAY	(-) HOOD PINSWITCH INPUT, ZONE 1
H3/5	BLUE/WHITE	(-) 200 mA 2ND STATUS/REAR DEFOGGER OUTPUT

► 4-pin satellite harness

1	BLUE	STATUS OUTPUT
2	ORANGE	ACCESSORY TRIGGER
3	PURPLE	STARTER TRIGGER
4	PINK	IGNITION TRIGGER

► Heavy gauge relay harness

H/1	PINK	(+) (30 AMP) OUTPUT TO IGNITION CIRCUIT
H/2	PURPLE	(+) (30 AMP) OUTPUT TO STARTER CIRCUIT
H/3	ORANGE	(+) (30 AMP) OUTPUT TO ACCESSORY CIRCUIT
H/4	RED	(+) (30 AMP) HIGH CURRENT 12v INPUT
H/5	PINK/WHITE	(+) PROGRAMMABLE OUTPUT FOR ACCESSORY OR IGNITION
	RED	(+) (30 AMP) HIGH CURRENT 12v INPUT

► Door lock harness, 3-pin connector

1	LIGHT BLUE	(-) UNLOCK OUTPUT
2	EMPTY	NOT USED
3	GREEN	(-) LOCK OUTPUT

Wire connection guides

► Primary harness (H1), 9-pin connector

H1/1	LIGHT GREEN/ BLACK	(-) FACTORY ALARM DISARM
-------------	-----------------------	--------------------------

Relay for Negative (-)
Disarm Wire

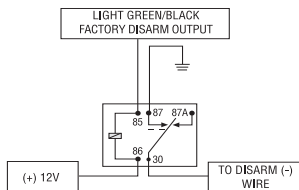

Relay for Positive (+)
Disarm Wire

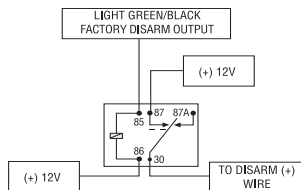

H1/2	GREEN/WHITE	FACTORY ALARM REARM OUTPUT
-------------	-------------	----------------------------

This wire sends a negative pulse every time the remote start shuts down or when the doors are locked. This can be used to pulse the arm wire of the vehicle's factory anti-theft device. Use a relay to send a (-) or (+) pulse to the arm wire.

H1/3	YELLOW	(+) IGNITION OUTPUT
-------------	--------	---------------------

As a stand-alone system: The H1/3 YELLOW wire should not be connected to anything and taped off.

As an add-on car starter: If connected, disconnect the ignition/accessory input of the remote controlled security or keyless entry system. Connect the H1/3 YELLOW ignition output to the ignition/accessory input of the remote controlled security or keyless entry system. The wire will prevent the host system from sensing that the ignition is on during remote engine start operation.

H1/4**WHITE/BLUE****REMOTE START (-) ACTIVATION INPUT**

This input comes from the factory set to 2 activation pulse. This means that it is necessary to have a two consecutive ground pulses on the white/blue wire for the remote start to activate or to deactivate. The same holds true for the remote control activation when set to a two pulse setting it is necessary to press the  button twice for the remote start to activate or deactivate.

Note: The number of activation inputs can be programmed to 1, 2 or 3 pulses. This setting affects both the input wire and the remote control when operating the remote starter.

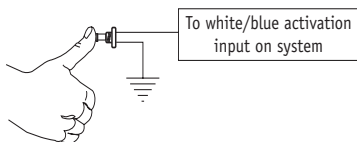
**H1/5****BROWN****200mA (-) HORN OUTPUT**

This wire is a low current output (200mA) and can be hooked to the horn honk wire in the vehicle. It can be programmed to sound only during full trigger or to be used like a siren output with arm/disarm chirps. Refer to System Features Menu#1, Feature 1 for more information.

H1/6**ORANGE****(-) GROUND-WHEN-LOCKED OUTPUT (GLW)**

This wire supplies a (-)500 mA ground as long as the system is locked. This output ceases as soon as the system is unlocked using the remote control. The GLW can be hooked up to a window control module, a voice module or any accessory that requires a ground when locked.

H1/7**RED/WHITE****CHANNEL 2, (-) 200mA OUTPUT**

This wire produces a (-) 200mA output for progressive locks in which the driver door unlocks first and the remaining locks unlock with a second press of the unlock button.



Warning! Never use this wire to drive anything but a relay or a low-current input, supplied output is only 200mA. Connecting directly to a solenoid, motor, or other high-current device will cause the module to fail.

H1/8**BLACK****(-) CHASSIS GROUND CONNECTION**

Remove any paint and connect this wire to bare metal, preferably with a factory bolt rather than your own screw. (Screws tend to either strip or loosen with time.) We recommend grounding all your components to the same point in the vehicle.

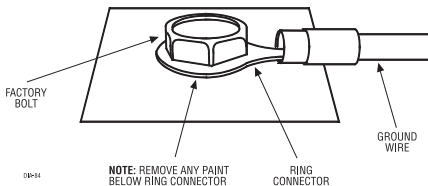

H1/9**WHITE****(+/-) LIGHT FLASH OUTPUT**

Important: Do NOT connect this wire to a negative vehicle light flash wire before changing the programming jumper to the negative polarity position or damage to the vehicle light circuit may occur.

As factory configured, the H1/9 WHITE wire should be connected to the (+) parking light wire. If the light flash polarity jumper is moved to the (-) position (refer to the Programming Jumper section of this guide), this wire then supplies (-) 200mA output.

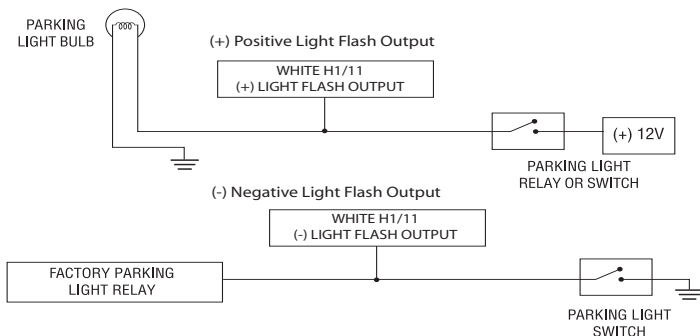

Note: For parking light circuits that draw 10-amps or more, the internal jumper must be switched to a (-) light flash output. (See Setting the light flash polarity section of this guide.) P/N 8617 or a standard automotive SPDT relay must be used on the H1/2 light flash output harness wire.

► Remote start harness, (H2) 5-pin connector

H2/1**BLACK/WHITE****NEUTRAL SAFETY SWITCH INPUT**

Connect this wire to the provided toggle (override) switch as shown in figure A. Connect the other wire from the toggle switch to the park/neutral switch in the vehicle. This wire will test with ground with the gear selector either in PARK or NEUTRAL. This will prevent the vehicle from accidentally being started while in a drive gear. This input **MUST** rest at ground in order for the remote start system to operate. Connected properly the vehicle will only start while in PARK or NEUTRAL.

In some vehicles, the park/neutral position switch activates a factory starter lock out that will not allow the starter to operate in a drive gear. In these vehicles, connect this wire to the toggle switch as shown in figure B. Connect the other wire from the toggle switch to chassis ground.

Important: Always perform the Safety Check section of this installation guide to verify that the vehicle cannot be started in ANY drive gear and that the override switch is functioning properly.

Figure A

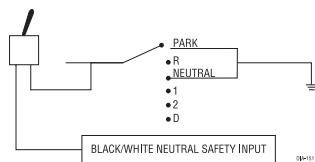

Figure B



H2/2

VIOLET/WHITE

TACHOMETER INPUT

This input provides the module with information about the engine's revolutions per minute (RPMs). It can be connected to the negative side of the coil in vehicles with conventional coils. In multi-coil and high energy ignition systems locating a proper signal may be more difficult. Once connected, you must teach the system the tach signal. (See the Internal Programming Jumpers section of this guide.

H2/3**BROWN****(+) BRAKE SWITCH INPUT, ZONE 1**

This wire **MUST** be connected to the vehicle's brake light wire. This is the wire that shows (+) 12V when the brake pedal is depressed. The remote start will be disabled or shut down any time the brake pedal is depressed.

H2/4**GRAY****(-) HOOD PIN SWITCH INPUT, ZONE 1**

This wire **MUST** be connected to a hoodpin switch. This input will disable or shut down the remote start when the hood is opened. .

H2/5**BLUE/WHITE****(-) STATUS OUTPUT**

This wire supplies a 200mA output as soon as the module begins the remote start process. The H2/5 Blue/White wire can also be used to activate the defogger trigger (latched/pulsed), 10-seconds after the remote start engages. (See the Feature Descriptions section in this guide for details about programming this output.)

► Heavy gauge relay 5-pin connector

H/1	PINK	(+) IGNITION OUTPUT
------------	-------------	----------------------------

Connect this wire to the ignition wire in the vehicle. (See, *Finding the wires you need* section in this guide.)

H/2	PURPLE	(+) STARTER OUTPUT
------------	---------------	---------------------------

Connect this wire to the starter wire in the vehicle. (See, *Finding the wires you need.*)

H/3	ORANGE	(+) ACCESSORY OUTPUT
------------	---------------	-----------------------------

Connect this wire to the accessory wire in the vehicle that powers the climate control system. (See, *Finding the wires you need*).

H/4	RED (2)	(+) 12V INPUT FOR HIGH CURRENT OUTPUTS
------------	----------------	---

H1/5	PINK/WHITE	(+) OUTPUT TO A SECOND IGNITION/ACCESSORY CIRCUIT
-------------	-------------------	--

Connect this wire to the second ignition/accessory wire in the vehicle. (See menu 1 feature 6 for more information.)

Note: For vehicles that do not have a second ignition/accessory wire, this connection is not required

H/6	RED (2)	(+) 12V INPUT FOR HIGH CURRENT OUTPUTS
------------	----------------	---

The heavy gauge wires coming from the large pin connector are used to energize the high current circuits in the vehicle. It is crucial to ensure that these connections are capable of handling the current demands. For this reason, Scotchlocks, T-taps and other such connectors are strongly discouraged

Remove the two 30-amp fuses prior to connecting these wires and do not replace them until the satellite has been plugged into the control module. These wires are the source of current for pink ignition, orange accessory, purple starter, and the coils for the relays in the relay pack. They must be connected to a high current source. Since the factory supplies (+)12V to the key switch that is used to operate the motor, it is recommended that these wires be connected there.

Note: If the factory supplies two separate (+) 12V feeds to the ignition switch, connect one RED wire of the satellite to each feed at the switch.

► Program switch - 2-pin connector

The program switch plugs into the blue two-pin connectors

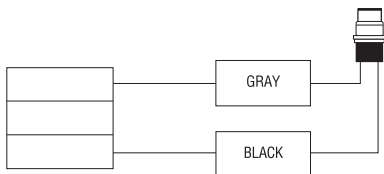

DIA-42

Neutral safety switch interface

Some vehicles combine the column shift mechanism and the mechanical neutral safety switch into one mechanical part. In these vehicles, it is impossible to interface the remote engine start system before the neutral safety switch. With this type of vehicle, if the vehicle is left in a drive gear and the remote engine start system is activated, the vehicle will move and may cause damage to persons or property.

According to available information, vehicles known to be manufactured this way are most General Motors trucks, sport utility vehicles and column shifting passenger vehicles. Available information also indicates that pre-1996 Dodge Dakota pickups with 2.5 liter motors are also manufactured this way.

GM vehicles that have the neutral safety switch built into the column shifter can usually be identified by a purple starter wire. Typically, vehicles that use an outboard mechanical switch use a yellow wire from the ignition switch to the mechanical switch and a purple wire from the mechanical switch to the starter itself. Remember, this is only a rule of thumb and is not intended as a substitute for proper testing.

Important: Please see vehicle Safety Check section of this guide for testing procedures.

Vehicles with the neutral safety switch built into the column shifter require that the shifter be placed in park in order to remove the keys from the ignition. As a result, it is possible to use the key-in-ignition sense switch to prevent remote engine starting if the keys are in the ignition. (*See General Motors Trucks, SUVs and Column-Shifting Passenger Cars and Pre-1996 Dodge Dakota Pickups with 2.5 Liter Motors diagrams in this section on how to accomplish this.*) The first diagram applies to all General Motors vehicles as of the date of this guide's publication. The second diagram applies to all pre-1996 Dodge Dakota pickup trucks with 2.5 liter motors. This solution has one side effect: If the customer inserts the key in the ignition with the driver's door open, the remote engine start system will shut down. If this interface is used, it is important to inform the customer that the driver's door must be closed before inserting the key into the ignition when the remote engine start is active. This will allow the customer to turn the key on and shut the remote engine start down by pressing the brake,

without the key sense wire shutting down the unit prematurely. You must also connect the H2/4 BROWN (+) shutdown input to the yellow wire on the relay satellite ribbon cable. This prevents the remote engine start system from activating if the key is left in the "run" position. You must use diodes to isolate the ignition circuit from the brake switch circuit as shown in the diagram below.

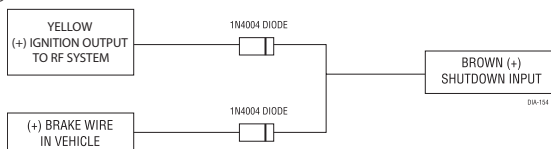

Important! Once the interface is complete, attempt to remote engine start the vehicle with the door closed and the key in the ignition. The vehicle should not start. If it does, re-check the connections.

As of the date of this guide's publication, the following list describes the types of vehicles that are known to have a mechanical neutral safety switch instead of an electrical neutral safety circuit. The model years will vary from vehicle to vehicle.

- Pre-1996 Dodge Dakota pickups with 2.5 liter engines
- GM "B" Platform: Caprice, Impala SS and Roadmaster
- GM "D" Platform: Cadillac Fleetwood and Fleetwood Brougham
- GM "P" Series: Commercial Van
- GM "L/M" Series: Astro, Safari
- GM "C/K" Series: Full-size pickup, Sierra, Suburban, Tahoe, Yukon
- GM "S/T" Series: Blazer, Bravada, Jimmy, pickup, Sonoma
- GM "G" Series: Express, Savannah

general motors trucks, SUVs, and column shifting passenger cars

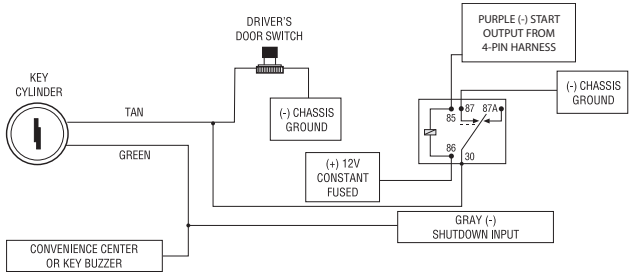

1107

pre-1996 dodge dakota pickups with 2.5 liter motors

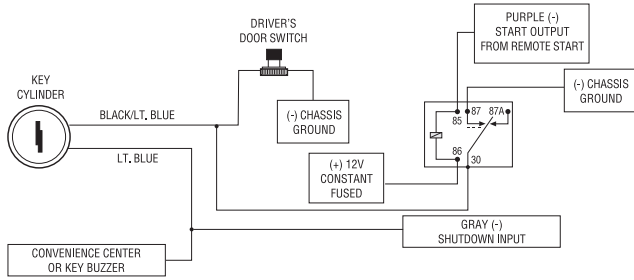

1108

Bypassing GM vehicle anti-theft systems (VATS)

Vehicles with the GM VATS (Pass Key) systems have a resistor embedded in the ignition key. If the VATS decoder module does not measure the proper resistance when the vehicle is started, the starter and fuel pump may be disabled for up to ten minutes.

The VATS wires will be two very light-gauge wires coming out of the steering column. The colors of the wires vary, but they are often contained in orange tubing - either both will be white wires, or one wire will be purple/white and the other white/black. Determine the value of the resistor in the key. Then follow the diagram below to bypass VATS during remote engine start operation. If the BLUE status output from the relay satellite has been programmed for factory security re-arm, then use the (H3/5) BLUE/WHITE 2nd status output from the control module to control the relay.

Note: When connecting to the VATS wires, it is not important which wire is cut.

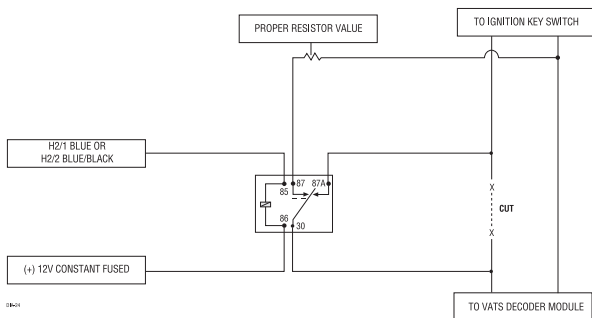

1995 and newer, VATS (immobilizers)

1995 and newer vehicle anti-theft systems (immobilizers) require a bypass module. The bypass module allows for easy interfacing, while still maintaining the OEM system's integrity.

passlock I and passlock II (PL-1 and PL-2)

The Passlock I and Passlock II systems can be found in the following General Motors vehicles:

- '95 and newer Cavalier and Sunfire
- '96 and newer Achieva, Grand Am, and Skylark
- '97 and newer Intrigue, Malibu, and Cutlass
- '98 and newer trucks, vans, SUVs
- '99 and newer Alero
- 2000 and newer Impala and Saturn
-

Passlock I and II systems are VATS-evolved. Passlock systems still rely on the R-code to start, but the pellet is no longer placed in the key. The resistor can now be found in the key switch. This allows for a greater number of possible R-codes. In addition, Passlock systems require "seeing" the correct R-code at the correct time. To bypass Passlock I and II, **p/n 556L(W)** or **p/n XK06** is required.

passkey III (PK-3), transponder-based systems

The Passkey III system can be found in the following vehicles:

- '97 and newer Park Avenue
- '98 and newer Cadillac
- '99 and newer U vans, Transport, Montana, and Silhouette
- 2000 and newer Grand Prix, Lesabre, Monte Carlo, Lumina, Bonneville
- 2001 and newer Aurora, Aztek and Rendezvous

Other transponder-based systems include: Acura, BMW, Dodge/Chrysler/Jeep, Ford, Honda, Infinity, Mazda, Mercedes, Mitsubishi, Nissan, Toyota, Volkswagon, and Volvo.

PK-3 and the transponder-based systems use a transponder system that locks out the ignition and fuel system. This transponder system is comprised of two parts. The first part, the transceiver, circles the key switch and is activated when the key is placed in the key switch or turned to the run position. Upon activation, the transceiver will excite the transponder, which is located (but not visible) in the head of the ignition key. The key transponder will then send a unique code back to the transceiver for evaluation. If the code matches a valid code of the system, the vehicle will be allowed to start. Most of these transponder-based systems can be bypassed using **p/n 556U(W)**. Some may require additional parts from the vehicle manufacturer. Consult you dealer for the applications. For most Ford PATS transponders, **p/n 555P, 1100F or XK04** can be used.

Optional anti-grind relay

The anti-grind relay prevents the starter from engaging if the ignition key is accidentally turned to the start position during remote engine start operation.

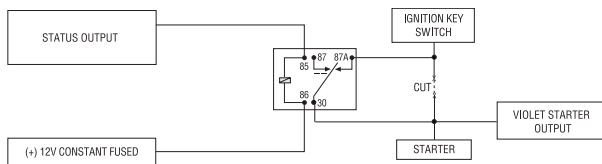

Tachometer settings

► Intelli-Tach

To program Intelli-Tach:

1. After the install is complete, remote start the car.
2. If the car does not start on the first attempt, let the remote start attempt again.
3. Once the car starts, let it run until the parking lights come on.
4. When the parking lights come on, shut off the remote start with the remote - that's it! Intelli-Tach is programmed.

To reset Intelli-Tach, go into the remote programming grid and choose option #4. Intelli-Tach **cannot** be reset with the ProSecurity Programmer.

Intelli-Tach handles disengaging the starter motor during remote starting – it does not address over-rev. If the customer wants to have the over-rev protection capability, now listed as optional in the owner's guide, the tach wire must be connected. This may involve more installation shop charges than initially quoted.

Important: If the Intelli-Tach mode over cranks or doesn't crank the vehicle long enough to start and run the car, use the ProSecurity Programmer to add or subtract the starter output time. You can adjust the output time in increments of 50mSec of the learned time using the ProSecurity Programmer.

► Tach learning

To learn the tach signal:



1. Start the vehicle with the key.



2. Within 5 seconds, press and hold the Program switch.



3. After 3 seconds the LED will light constant when the tach signal is learned.



4. Release the Program switch.

Programming jumpers

► Light flash (+) / (-) polarity

This jumper is used to determine the light flash output polarity. In the (+) position, the on-board relay is enabled and the unit will output (+)12V on the WHITE wire, H1/2. In the (-) position, the on-board relay is disabled. The WHITE wire, H1/2, will supply a 200mA (-) output suitable for driving factory parking light relays

NOTE: For parking light circuits that draw 10 amps or more, the internal jumper must be switched to a (-) light flash output. **P/N 8617** or a standard automotive SPDT relay must be used on the H1/9 light flash output harness wire.

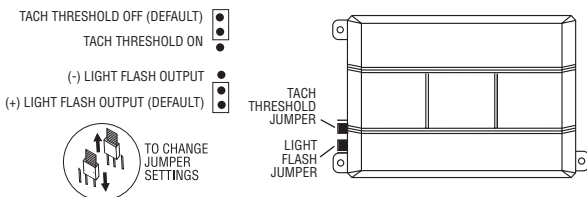

► Tach threshold On/Off

In most cases, this jumper can be left in the Off position. Some new vehicles use less than 12 volts in their ignition systems. The unit may have trouble learning the tach signal in these vehicles. Changing the jumper to the On setting changes the trigger threshold of the digital tach circuit so that it will work with these type vehicles.

Transmitter/receiver Learn Routine™

The system comes with transmitters that have been taught to the receiver. The receiver can store up to 4 different transmitter codes in memory. Use the following learn routine to add transmitters to the system.

The Program switch, plugged into the blue port, is used for programming. There is a basic sequence to remember whenever programming this unit: Key, Choose, Transmit and Release.



1. Insert the key. Turn the ignition to the ON position. The heavy gauge pink wire must be connected.



2. Choose. Within 10 seconds, press and release the Program switch corresponding to the number of the desired function step listed in the following table.

Once you have selected the function step, press the switch once more and hold it. The LED flashes and the horn honks to confirm the selected functional step. Do not release the Program switch.

Channel	Function
1	Auto Learn Standard Configuration (default) The auto learn configuration will automatically setup the remote button configuration. .
2	Delete remotes: This feature will erase all remotes from the memory of the system. This is useful in cases when a customer's remote is lost or stolen.
3	Reset Features: This resets all the features of the system to the factory default settings.
4	Intelli-Tach Reset: Deletes all previously learned values for Intelli-Tach, and on the next remote start sequence the unit will begin Intelli-Tach initialization.



3. Transmit. While holding the Program switch, press the  button on the remote control. The horn honks to confirm that the code has been successfully programmed. It is not possible to teach a remote button to the system more than once.



4. Release. Once the code is learned, the Program switch can be released.

You can advance from programming one channel to another by releasing the Program switch and tapping it to advance channels and then holding it.

For instance: You have programmed Channel 1 and you want to program Channel 3. Release the Program switch. Press it two times and release it to advance from Channel 1 to Channel 3. Now, press and hold the Program switch. The LED flashes three times. As before, do not release it.

Learn Routine is exited if:

- The ignition is turned off
- The program switch is pressed too many times
- More than 25 seconds elapses between steps

Transmitter configurations

The transmitters are programmed with the standard configuration by using the Auto Learn functions in the Transmitter/Receiver Learn Routine. For more information about the remote control functions, see the Owners Guide.

► Standard configuration



operates

Lock
Panic Mode



operates

Unlock



operates

Remote start

AUX

operates

Channel 2



and



operates

Timer Mode



and



and

AUX

operates

Rear defogger

Operating settings learn routine

The system features programmed dictates how the unit operates. Due to the number of features, the features have been divided into two menus. It is possible to access and change any of the feature settings using the Override switch. However, this process can be greatly simplified by using a ProSecurity Programmer. The remote coding may be locked if previously programmed using the ProSecurity Programmer. If the horn generates one long honk when attempting to program the unit, the remote coding is locked and must be unlocked using the ProSecurity Programmer before proceeding.



1. Key. Turn the ignition on, and then off.
2. Select menu. Press and hold the Program switch.



When the LED flashes once and the horn honks, Menu One has been selected. Continue to hold the switch until the LED flashes twice and the horn honks twice, Menu Two has now been selected. Release the switch after the Menu choice has been selected.



3. Choose. Within 10 seconds, press and release the Program switch the number of times corresponding to the feature number you want to program and then press and hold the switch. .



4. Transmit. The transmitter is used to select the desired setting. Pressing button one changes the feature to the LED On setting (or flashes once for features with more than 2 settings). The horn honks once. Pressing button 2 changes the setting to the LED OFF setting (or flashes two or more times for features with more than 2 settings) .



5. Release, the Program switch.

You can advance from feature to feature by pressing and releasing the Program switch the number of times necessary to get from the feature you just programmed to the feature you wish to access. For example, in Menu One, if you just programmed Feature 1-2 and you next want to program Feature 1-3 to off, release the Program switch. Press and release it once to advance from Feature 1-2 to Feature 1-3. Then press it once more and hold it. The LED will flash in groups of 3 to confirm that you have accessed Feature 1-3.

The learn routine is exited when:

- The ignition is turned on.
- The Program switch is pressed too many times.
- More than 25 seconds elapses between programming steps.

Feature menus

The default settings are indicated in bold type. The number in parentheses indicates the number of times the LED flashes.

► Menu 1

FEATURE NUMBER	LED ON SETTING (DEFAULT) (PRESS CHANNEL 1)	LED OFF SETTING (PRESS CHANNEL 2)
1	Horn Honk Pulses OFF	20ms (2), 30ms (3), 40ms (4), 50ms (5)
2	Ignition Lock OFF	Ignition Lock ON
3	Ignition Unlock OFF	Ignition Unlock ON
4	Door Lock Pulse Duration 0.8 seconds	3.5 (2) , 0.4 (3) seconds
5	Unlock Output 1 pulse	Unlock Output 2 pulses .
6	Lock Output 1 pulse	Lock Output 2 pulses
7	Factory Alarm Disarm Function w/Unlock	Before Unlock (2), Remote Start Only (3)
8	Factory Alarm Disarm 1 pulse	2 pulses
9	Comfort Closure OFF	Version(1), Comfort Closure Version 2 (3)
10	Panic Mode ON	Panic Mode OFF

NOTE: The numbers in the parantheses indicate the number of times the LED will flash.

► Menu 2

FEATURE NUMBER	LED ON SETTING (DEFAULT) (PRESS CHANNEL 1)	LED OFF SETTING (PRESS CHANNEL 2)
1	Intelli-Tach	Voltage (2), off (3), Tachometer (4)
2	12 Minutes Run Time	24 Minutes (2), 60 Minutes (3)
3	Constant Parking Light Output	Flashing Parking Light Output
4	Cranking Time 0.6 sec	Cranking Time 0.8 (2), 1.0 (3), 1.2 (4), 1.4,(5)1.6 (6), 1.8 (7), 2.0 (8), 4.0 (9)sec.
5	Activation Pulse: 1	Activation Pulses: 2 (2) , 3 (3)
6	Ignition/Accessory Output: Ignition	Ignition/Accessory Output: Accessory
7	Accessory State During Wait to Start: OFF	Accessory State During Wait to Start: ON
8	2nd Status Output: Normal	Rear Defogger Latched (2), Pulsed (3)
9	Anti-grind ON	Anti-grind OFF
10	Wait to Start Timer = 0 Sec	15 (2), 30 (3), 45 (4) seconds

NOTE: The numbers in the parantheses indicate the number of times the LED will flash.

Feature descriptions

The features of the system are described below. **Default settings are in bold.** The numbers in parentheses indicate the number of times the Status LED flashes.

► Menu 1

1-1 Horn Honk Pulses OFF: (1) No audible confirmation on Lock or Unlock. (2) 20ms horn honk, (3) 30ms horn honk, (4) 40ms horn honk, (5) 50ms horn honk

1-2 Ignition Locks OFF/ON: (2) When turned on Locks the doors three seconds after the ignition is turned On and the vehicles doors are closed. (1) When turned Off the system does not lock the doors when the ignition is turned on.

1-3 Ignition Unlocks OFF: (2) Unlock: When turned On Unlocks the doors when the ignition is turned off. (1) When turned Off the system does not unlock the doors when the ignition is turned off.

1-4 0.8 sec Door Lock Pulse (1)Duration: The default setting is 0.8 second door lock pulses. Some European vehicles, such as Mercedes-Benz and Audi, require longer lock and unlock pulses to operate the vacuum pump. Programming the system to provide 3.5 second (2) pulses, accommodates the door lock interface in these vehicles. (See door lock connections section for wiring information regarding Type E door locks interfacing. The 0.4 second (3) pulse is required on some vehicles where the lock wires can also control the windows and the 0.8 second pulse causes the windows to open/close when locking or unlocking.

1-5 Single Pulse Unlock (1): The system sends out a single pulse when unlocking. (2) Double-pulse unlock sends out 2 pulses when unlocking.

1-6 Single Pulse Lock (1): The system sends out a single pulse when locking. (2) Double-pulse lock sends out 2 pulses when locking.

1-7 Factory Alarm Disarm-With Unlock, Before Unlock, Remote Start Only: In the default setting the factory alarm disarm output will disarm the factory alarm system any time the button controlling Unlock or Remote Start is pressed. The "Before Unlock" output will disarm the factory alarm before the unlock output activates and when remote start is activated. The "Remote Start Only" will disarm the factory alarm only when the remote start is activated.

1-8 Factory Alarm Disarm 1 pulse: FAD 2 pulses. This setting determines how many pulses the system will output on the Factory alarm disarm wire.

1-9 Comfort Closure 1

The system can be programmed to close the windows when the system is locked. If programmed ON, the lock output provides a 20 second pulse when the system is locked. The output will be cancelled if the unlock button is pressed. In the Off setting the system will not do this function. (3) Comfort Closure 2 - Activates the 20 second timer with the door lock pulse. (2) Comfort Closure 1 - Activates the 20 second timer after the door lock pulse.

To test if the car has the comfort closure:

1. Insert the key into the driver's door key cylinder.
2. Turn the key to the lock position and hold for about 10 seconds. If Comfort closure is available, the windows (and in some cars the sunroof) will close.

Note: Some cars require that you turn the key once, release it and then turn and hold into lock position.

Important: Comfort closure can only be used on cars that have the capability of closing the windows (and in some cars the sunroof as well) with the key cylinder in the door.

1-10 Panic Mode ON/OFF: When On the panic feature can be activated at any time from the remote and will sound for 30 seconds. When off, the panic feature does not function.

► Menu 2

2-1 Engine Checking Intelli-Tach: (1) When set to "Intelli-Tach" (1) the remote start monitors the cranking voltage of the vehicle and sets it as a reference point. Fifteen seconds after the crank output sequence the remote start checks the voltage again to determine if the vehicle is running.

When set to voltage, (2) the unit cranks the starter for the programmed time and then attempts to sense that the engine is running by detecting an increase in voltage. If programmed Off (3) the vehicle cranks for the programmed crank time. The tach setting or voltage setting is not checked to verify that the car is running. In the OFF setting, if the vehicle fails to start, the ignition stays on for the run duration. Using tach or either of the voltage settings is recommended.

When set to Tachometer, (4) the unit references the learned tach signal to disengage the starter. In addition it will monitor the RPM and shut down if the engine RPM is too high or too low.

Important: The tach wire must be connected and programmed for the manual transmission mode to work.

2-2 Run Time 12 (1), 24 (2) 60 (3) MINUTES: Selects the time in minutes that the system will operate the engine until the system "times out". The system may be shut down using the remote or any of the shutdowns at any time. Using the ProSecurity Programmer the run time can be programmed for any duration from 1-60 minutes.

2-3 Parking Lights Constant: In the default setting, the parking lights will come ON solid, when the vehicle is remote started. In the two- flash setting the parking lights will flash during the remote start runtime..

2-4 Crank Time 0.6(1) 0.8 (2) 1.0 (3) 1.2 (4) 1.4 (5) 1.6 (6) 1.8 (7) 2.0 (8) 4.0 (9) SECONDS: If the unit is programmed for no engine checking or voltage sense, the crank time must be set to the appropriate duration. The default setting is 0.6 second and the LED will flash once. If a different crank time is desired, toggle through the higher settings by using the two-honk settings.

2-5 Activation Pulse One: This allows the system to use 1, 2 or 3 pulses to activate the remote start sequence. The default setting is 1-pulse.

Note: This setting affects both the input wire and the remote control.

2-6 2nd—IGNITION/ACCESSORY OUTPUT: This will allow the PINK/WHITE to be used as a 2nd ignition or a 2nd accessory.

2-7 Accessory State During Wait-To-Start OFF: This feature will allow the selection of the accessory output to be ON or OFF during wait-to-start. Use the two-honk setting for On.

2-8 2nd STATUS OUTPUT—NORMAL/LATCHED/PULSED: If programmed to status mode, this output will turn on when the remote engine start is activated. In this mode the output can be programmed to a latched or a pulsed output. The pulsed output turns the defogger ON. When programmed to the latched output the status will only stay active for 10 minutes. Both outputs activate 10 seconds after remote engine start.

2-9 Anti-Grind On: With the anti-grind On (default) the ground-when-locked output will be active during remote start operation. This activates the optional starter kill relay and prevents the customer from re-cranking the car with the key, when doing key takeover. If accessories such as a voice module or window module are added to the unit, it may be necessary to use the two-honk setting to program this feature OFF.

2-10 Diesel Timer—Wait-To-Start Input - Timed 0, 15, 30, 45 SECONDS: Default is 0 second delay. Also available is a delay of 15 (2), 30 (3), or 45(4) seconds. This feature can also be optionally programmed with the ProSecurity Programmer, with a delay from 1 to 90 seconds.

Shutdown diagnostics

To perform shutdown diagnostics:



1. With the ignition OFF, press and hold the Program switch.
2. Turn the ignition ON and then back OFF while holding the Program switch.
3. Release the Program switch.
4. Press and release the Program switch. The LED reports the last shutdown for one minute or until the ignition is turned on, as shown in the following table:

LED Flashes	Shutdown Mode
1	Timed out
2	Over-rev shutdown
3	Low or no RPM
4	Transmitter shutdown (or optional push button)
5	(-) Shutdown (H3/4 GRAY) or (+) Shutdown (H3/3 BROWN)
6	(+) Brake shutdown
7	(-) Neutral safety shutdown (H3/1 BLACK/WHITE)

Rear defogger control



The rear defogger output can be remotely turned on/off any time using the remote control. The default setting is **On**.

To turn the rear defogger output OFF:

1. Press & release the  and  and **AUX** buttons of the remote control.
2. The parking lights will flash 2-times.
3. The rear defogger output will no longer activate when the vehicle is remote engine started.



Note: If the remote engine start is On the lights will turn off then flash 2-times before returning to their normal output and the defogger output, if active, will cease.

To turn the rear defogger output ON:

1. Press & release the  and  and **AUX** buttons of the remote control.
2. The parking lights will flash 3-times.
3. The rear defogger output will once again activate when the vehicle is remote engine started.

Note: If the remote engine start is On the lights will turn off then flash 3-times before returning to their normal output and the defogger output will activate as programmed.

Timer mode

By pressing the remote  and  buttons simultaneously the parking lights will flash 4 times and then start the vehicle and run for the set duration. The remote engine start can be shut off by the transmitter by pressing the remote engine start button  and remain in timer mode, but if any other shut down zones or the ignition .

1. Press Timer mode buttons.
2. The vehicle will confirm with 4 parking light flashes.
3. A 1-second delay will start.
4. The system will start the car and will run for the specified duration, unless shut down by the remote engine start button  (or the +/- input).
5. The system will start every 3 hours until canceled by the brake, hood, or neutral safety shut-down wires (a maximum of 6 times).

Important! Timer Mode should be used only in open areas. Never start and run the vehicle in an enclosed space such as a garage or carport

Safety check

Before vehicle reassembly, the remote start system must be checked to ensure safe and trouble-free operation. The following test procedure must be used to verify proper installation and operation of the system. The installation must be completed before testing, including connection to the brake switch and hood switch.

1. Test the BRAKE shutdown circuit: With the vehicle in Park (P), activate the remote start system. Once the engine is running, press the brake pedal. The engine should shut down immediately. If the engine continues to run, check the brake circuit connection.
2. Test the HOOD PIN shutdown circuit: With the vehicle in Park (P), open the hood. Activate the remote start system. The vehicle should not start. If the starter engages, check your hood pin and connections.
3. Test the NEUTRAL SAFETY shutdown circuit.

Important: Make sure there is adequate clearance to the front and rear of the vehicle before attempting this test.

4. Make sure the hood is closed and no other shutdown circuits are active.
 5. Set the emergency brake.
 6. Turn the ignition key to run position but do not start the engine.
 7. Put the vehicle in Drive (D).
 8. Put your foot over the brake pedal but do not press down on it. Be ready to step on the brake to shutdown the remote start system.
 9. Activate the remote start system.
- If the starter engages, immediately step on the brake to shut down the system. If it does engage, recheck the neutral safety input connection. The vehicle may use a mechanical neutral safety switch. (See H2/1 BLACK/WHITE neutral safety switch input in Remote Start Harness Wire Connection Guide section of this guide.)
 - If the starter does not engage, the test is complete. Once the system passes the tests, the vehicle can be re-assembled and delivered. Do not use the remote start system or finalize the installation if it fails any of the safety check tests.

Troubleshooting

- **The ignition comes on, but the starter will not crank.**

Does it start with the key in the ignition? If so, does the vehicle have a VATS Pass-Key system?

Will it start with the brake pedal depressed? (Make sure to disconnect the brake shutdown when performing this test.) If so, it may have a brake/starter interlock.

Is the correct starter wire being energized? Check by energizing it yourself with a fused test lead.

- **The starter cranks for six seconds but does not start.**

Either the wrong ignition wire is being energized, the system's ignition and accessory wires have been connected backwards, or the vehicle has two ignition circuits. Try activating the unit with the ignition key in the "run" position. If the vehicle then runs normally, retest your ignition system.

- **The starter continues to crank even though the engine has started.**

Has the tach wire been learned? See the *Tach Learning* section of this guide.

Is the tach wire receiving the correct information? Either the wrong tach wire has been used, or a bad connection exists.

- **The remote start will not activate**

1. Check the harnesses and their connections. Make sure that the harnesses are completely plugged into the remote start module. Make sure there are good connections to the vehicle wiring.
2. Check voltage and fuses on the main 12-pin harness and on the heavy gauge remote start harness.
3. Check diagnostics. The diagnostics will tell you which shutdown is active or not connected.

- **The remote start will activate, but the starter never engages.**
 1. Check for voltage on the purple starter wire two seconds after the remote start becomes active. If there is voltage present, skip to Step 4. If there is not voltage present, advance to Step 2.
 2. Check the 30A fuses.
 3. If the gray/black wait-to-start wire is detecting ground upon activation, the starter will not crank.
 4. Make sure the purple starter wire is connected on the starter side of the optional starter kill/anti-grind relay.
 5. Does the vehicle have an immobilizer? Some immobilizer systems will not allow the vehicle to crank if active.
 6. Check connections. The heavy gauge remote start input wires on the heavy gauge 10-pin connector should have a solid connection. "T-taps" or "scotch locks" are not recommended for any high current heavy gauge wiring.

- **The vehicle starts, but immediately dies.**
 1. Does the vehicle have an immobilizer? The vehicle's immobilizer will cut the fuel and/or spark during unauthorized starting attempts.
 2. Is the remote start programmed for Intelli-Tach voltage sense? If so, the crank time may not be set high enough. Voltage sense will not work on some vehicles.
 3. Check diagnostics. Sometimes a shutdown will become active during cranking or just after cranking.

- **The vehicle starts, but the starter keeps running.**
 1. Is the system programmed for engine checking off or Intelli-Tach voltage sense? When programmed for either of these features, the engine cranks for the pre programmed crank time regardless of how long it takes for the vehicle to actually start. Adjust to a lower cranking time.
 2. Was the Tach Learn successful? The LED must light solid and bright to indicate a successful learn.
 3. Make sure that there is a tach signal at the purple/white tach input wire of the remote start. If there is not a tach signal, recheck the connection to the vehicle's tach wire and make sure the wire is not broken or shorted to ground leading to the remote start.

- **The vehicle starts, but will only run for 10 seconds.**
 1. Is the remote start programmed for voltage sense? If this does not work, a tach wire should be used.
 2. Check shutdown diagnostics.

- **The climate control system does not work while the unit is operating the vehicle.**

Either the wrong accessory wire is being energized or more than one ignition or accessory wire must be energized in order to operate the climate control system.

Wiring quick reference guide

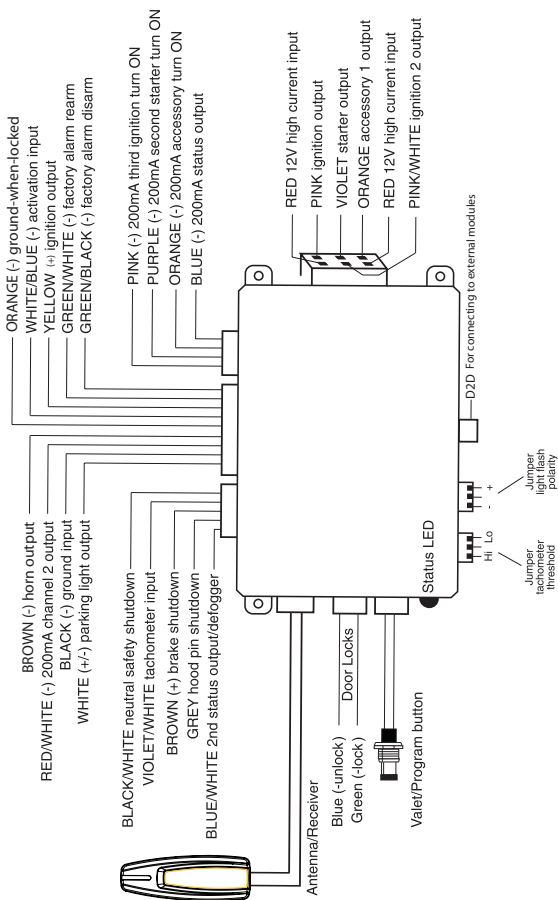

***Get Started
Get Protected***



**Ungo ProSecurity
6200 Gateway Drive
Cypress, CA 90630**

**www.Clarion.com
800-GO-CLARION**