

Real Flat Television

User Manual

2IPT5007

2IPT5017

2IPT5027

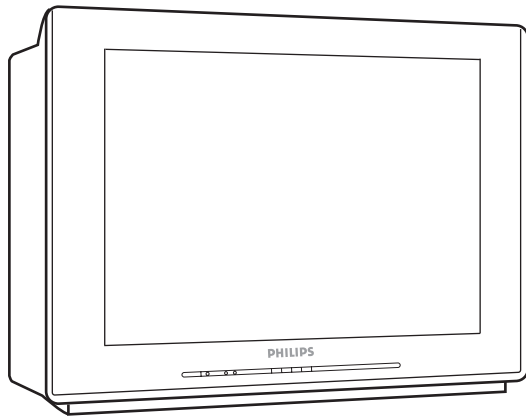

PHILIPS

CONTENTS

Introduction

Safety information and Tips	3
Before calling Customer Service	4

Basic Installation functions

Getting started	5
Connecting Audio/Video (Playback)	6
Connecting Audio/Video (Recording)	7
Functions of the Remote control	8
Functions of the TV control panel	9

TV Installation

Selecting the Main Menu	10
Selecting your menu language	11
Tuning your channels automatically	12
Tuning your channels manually	13
Fine Tuning your channels	15
Changing the system settings	16
Adjusting the TV picture	17

Features

Swapping your TV channels	18
Skipping channels	19
Storing your favourite channels	20
Setting the Timer	21

General

Specifications	23
----------------------	----



Recycling Directive – To minimise harm to the environment, the batteries supplied with the TV set do not contain mercury or nickel cadmium. If possible, when disposing of batteries, use recycling means available to you. Your TV set uses materials which are reusable or which can be recycled. To minimise the amount of waste in the environment, specialist companies recover used sets for dismantling and collection of reusable materials (contact your dealer).

SAFETY INFORMATION AND TIPS

Safety information

- remove mains plug when :
 - the red light below the TV screen is flashing continuously.
 - a bright white line is displayed across the screen.
 - cleaning the TV screen. Never use abrasive cleaning agents such as scouring powder. Use a slightly damp chamois leather or soft cloth.
 - there is a lightning storm.
 - the set is left unattended for a long period of time.
- No naked flame sources, such as lighted candles, should be placed on top of the TV or in the vicinity.
- Do not place your TV set under direct sunlight or heat.
- Leave at least 5 cm around each side of TV set to allow for proper ventilation.
- Avoid placing your set (e.g. near the window) where it is likely to be exposed to rain or water.
- No objects filled with liquids should be placed on top the TV so as to avoid dripping or splashing of liquids on the set.

Tips

- Do not leave your set on standby mode for a prolonged period of time. Switch off set to allow it to be demagnetised. A demagnetised set supports good picture quality.
- Do not shift or move the set around when it is switched on. This will result in unevenness in colour in some parts of the screen.
- Never try to repair a faulty TV yourself. Always check with a skilled service personnel.

BEFORE CALLING CUSTOMER SERVICE

Below is a list of frequently occurred symptoms. Before you call for service, make these simple checks. Some of these symptoms can easily be rectified if you know what to do.

<u>Symptoms</u>	<u>What you should do</u>
Colour patch (unevenness)	<ul style="list-style-type: none"> - Switch off the TV from the mains power button. Wait for 20 minutes before switching on again. - Check the TV is not placed too near speakers or magnetic objects.
No power	<ul style="list-style-type: none"> - Check the TV's AC power cord is plugged into the mains socket. If there is still no power, remove the plug. Wait for 60 seconds and re-insert plug. Switch on the TV again.
No picture	<ul style="list-style-type: none"> - Check the antenna connection at the rear of the TV. - Possible TV station problem. Try another channel.
Good picture but no sound	<ul style="list-style-type: none"> - Try increasing the volume. - Check that the sound is not turned off. If it is turned off, press the Mute button on the remote control to restore sound.
Good sound but poor colour or no picture	<ul style="list-style-type: none"> - Try increasing the contrast and brightness setting.
Snowy picture and noise	<ul style="list-style-type: none"> - Check antenna connection at the rear of the TV.
Horizontal dotted lines	<ul style="list-style-type: none"> - Possible electrical interference e.g. hairdryer, vacuum cleaner, etc. Switch off appliances.
Double images or "Ghost" images	<ul style="list-style-type: none"> - Possible poor positioning of antenna. Use of a highly directional antenna may improve reception.
TV not responding to remote control	<ul style="list-style-type: none"> - Check life span of batteries of remote control handset. - Aim remote control directly at remote sensor lens on the front panel of the TV.

GETTING STARTED

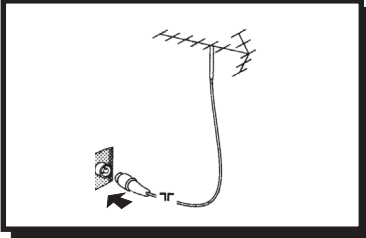

Connecting the antenna

- Connect the aerial plug to the antenna socket on the backcover.
- Insert the mains plug into the wall socket.

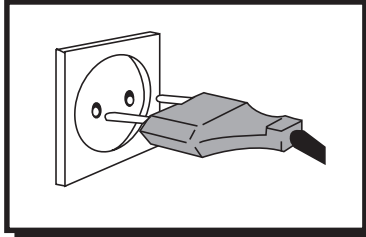

Connecting the mains

- For correct mains voltage, refer to type sticker at the rear of the TV set
- Consult your dealer if mains supply is different.
Note : This diagram is not representative of the actual plug and socket.

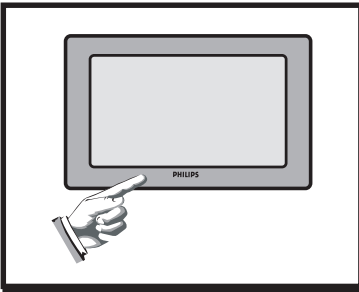

Switching on the set

- Press the main power button to switch on/off the TV.
- If the set is on standby (indicator is lit), press the Power button on the remote control to switch on set.

Disconnecting from the mains

- The mains switch  on the TV is used as a disconnecting device.

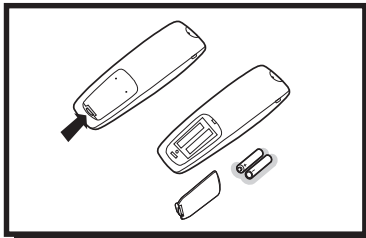

Installing the remote control batteries

- Insert the correct type of batteries into the compartment.
- Ensure the batteries are placed in the right direction.

CONNECTING AUDIO/VIDEO (PLAYBACK)

Connection for viewing VCRs

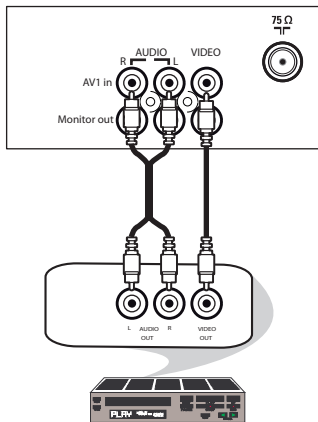

AV sockets on
rear of TV

Back of VCR
(with Video and
Audio output sockets)

You can view the playback of VCR tapes (Video Disc players, camcorders, etc.) by using the AUDIO and VIDEO INPUT sockets on the rear of the TV.

NOTE: the video and audio RCA cables from the VIDEO and AUDIO IN on the rear of the TV to the AUDIO and VIDEO OUT of the VCR. Rear AV input and Side AV input cannot be used simultaneously. As the Side AV does not have the Auto priority, you will have to manually switch to Side AV with the  button to receive video and audio content of the video camera.

CONNECTING AUDIO/VIDEO (RECORDING)

Connection for recording from the TV channel to VCR

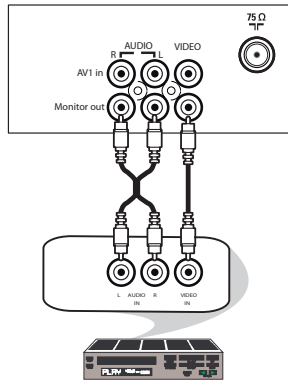

AV sockets on the rear of TV

Back of VCR (with Video and Audio input sockets)

- Connect the video and audio RCA cables from the VIDEO and AUDIO IN sockets of the VCR to the MONITOR OUT on the rear of the TV.

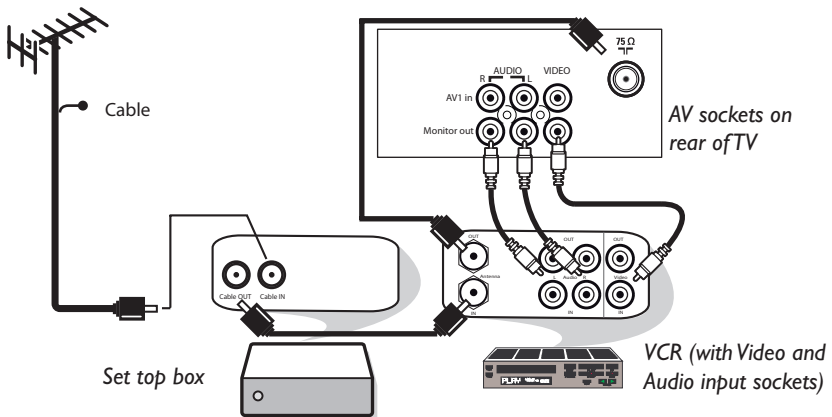

AV sockets on rear of TV

VCR (with Video and Audio input sockets)

- Connect the RF cable from the OUTput of the set top box to the Antenna IN of the VCR. From the VCR's Antenna OUT, connect the RF cable to the Antenna socket on the rear of the TV.
- Connect the video and audio RCA cables from the VIDEO and AUDIO IN sockets of the VCR to the MONITOR OUT on the rear of the TV.

FUNCTIONS OF THE REMOTE CONTROL

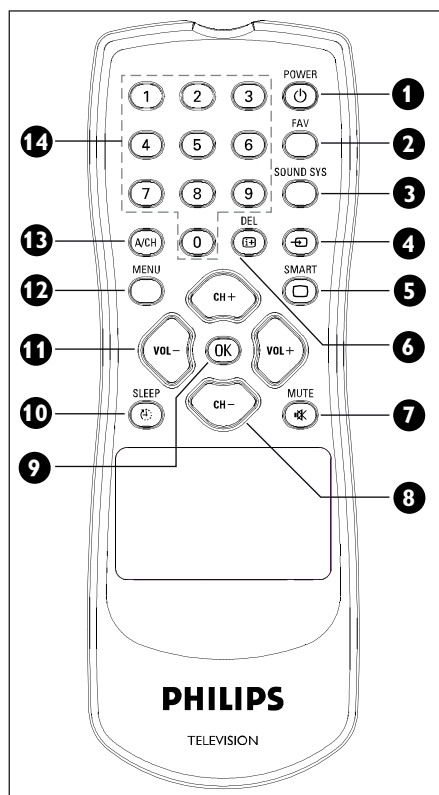

This TV features a full-function remote control. Its compact design is the result of having many of the buttons with multiple functions.

- 1 POWER button**
To turn on the TV or switch it to Standby mode.
- 2 FAV button**
To browse the channels you set in your Favourite list.
- 3 SOUND SYS button**
To directly select a sound system without entering the submenu.

- 4 Input button**
To select an input signal (TV, AV1 or AV2).
- 5 SMART PICTURE button**
To select Personal, Soft, Natural or Rich picture.
- 6 DEL / Info button**
To display information such as channel number; colour system, sound system or the time.
In Favourite Channel submenu, press to delete the favourite channel number.
- 7 MUTE button**
To turn on or turn off sound.
- 8 CH+ / CH- button**
To select channels in ascending or descending order.
In menu operation, to highlight a menu item.
- 9 OK button**
To enter submenu or confirm menu operation.
- 10 SLEEP button**
To set sleep timer from 10 to 120 minutes (in 10 minute intervals), cancel sleep timer or display remaining time.
- 11 VOL+ / VOL- button**
To turn up or turn down the sound.
In menu operation, to adjust the setting for all selected options.
- 12 MENU button**
To display main menu or return to previous screen.
- 13 A/CH (Alternate Channel) button**
To toggle last viewed channel or current channel.
- 14 0-9 numeric buttons**
To directly select TV channel number.

FUNCTIONS OF THE TV CONTROL PANEL

The TV controls are on the front panel just below the screen.

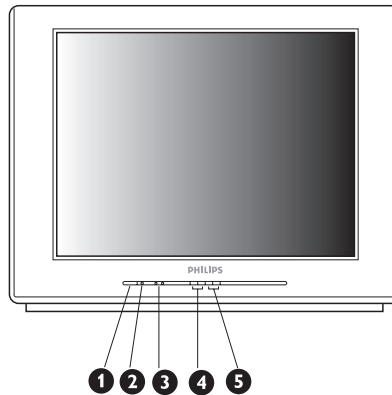

1	Mains Power button	Press to turn on or turn off TV. If TV is in Standby mode, press: - CH \wedge or CH \vee on the TV front panel or - POWER button on the remote control to turn on TV.
2	Standby light indicator	Indicator is lit when standby mode is activated. To switch TV to Standby mode, press the POWER button on the remote control.
3	Remote Sensor	Acts as a sensor for activating the controls of the TV when remote control handset is aimed at it.
4	Volume + / - buttons	To turn up or turn down the TV sound.
5	Channel \wedge / \vee buttons	Select channel in descending/ascending order.

TIP:

- You can enter the main menu by pressing both the Volume + and Volume - buttons at the same time.
- Press the Channel \wedge or \vee buttons to select the next item on the menu.
- Press Volume + or Volume - button to access sub-menu and adjust the settings.

SELECTING THE MAIN MENU

The User Manual explains the operation of the TV set using the buttons on the remote control unless otherwise stated. Please read the following instructions carefully and follow the steps as shown to familiarise yourself with installation and other features available for your TV set.

TIP:

You may encounter instability of the on-screen display when there is no signal input to the TV. When this happens, use the  button on your remote control to select an AV channel.

Step

Press button

Result on screen

1

MENU Enter main menu.
The Picture main menu is always selected by default.

The Main Menu (top panel) shows four symbols: Picture, Feature, Timer and Preset.

Use the VOL+ or VOL- buttons to select the main menu items.

The Submenu (main panel) displays the menus of the selected main menu item. Use the CH+ or CH- to select the submenu items.

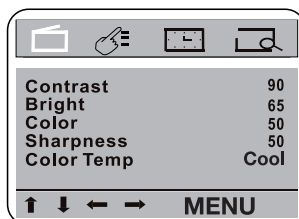

2

CH+ To navigate the submenu items.
Or
CH- Example: The Brightness submenu item is selected as shown.

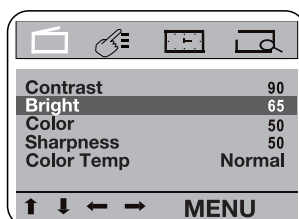

3

VOL+ To adjust the individual submenu items.
Or
VOL- Example: Press repeatedly to adjust the brightness level.

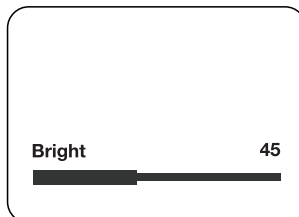

4

MENU Exit menu from screen.

SELECTING YOUR MENU LANGUAGE

The **Language** option lets you set your language for the TV's on-screen display menus.

Step

Press button

Result on screen

1

MENU Enter main menu.

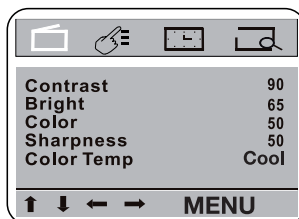

2

VOL+ Or **VOL-** Press repeatedly until the **FEATURE** main menu is selected.



3

CH+ Or **CH-** Press repeatedly until the **Settings** submenu is selected.

4

OK Enter **Settings** submenu.

5

CH+ Or **CH-** Press repeatedly until the **Language** submenu is selected.

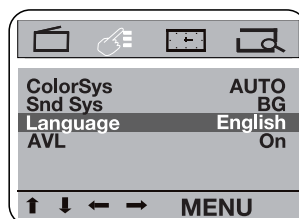

6

VOL+ Or **VOL-** Press repeatedly to toggle between the available languages you want to select.

7

MENU Exit menu from screen.

TUNING YOUR CHANNELS AUTOMATICALLY

You can search for all active channels automatically with the **Auto Store** feature.

Step

Press button

Result on screen

1

MENU Enter main menu.

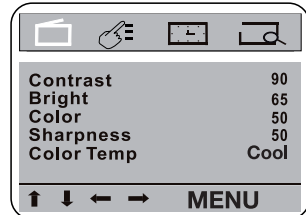

2

VOL+ Or **VOL-** Press repeatedly until the **PRESET** main menu is selected.

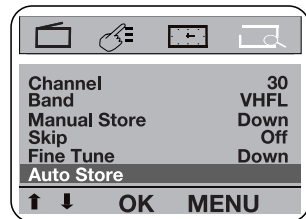

3

CH+ Or **CH-** Press repeatedly until the **Auto Store** submenu is selected.

4

OK Auto searching will begin. All available channels found will be stored from number 1 onwards. When all frequency bands have been searched, auto searching will stop. The program of the first searched channel will be displayed.

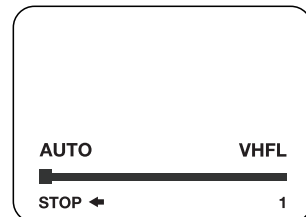

5

VOL- To stop auto searching.

6

MENU Exit menu from screen.

TUNING YOUR CHANNELS MANUALLY

You can manually search your channel from any frequency band and select your preferred channel number with the **Manual Store** feature.

Step

Press button

Result on screen

1

MENU Enter main menu.

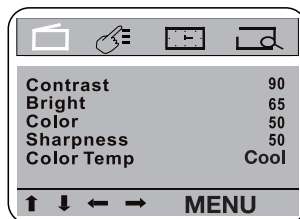

2

VOL+ Press repeatedly until
Or **Preset** main menu is
VOL- selected.

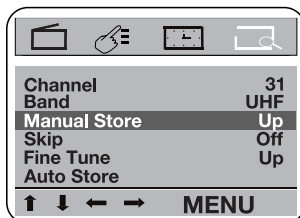

3

CH+ Press repeatedly until
Or **Channel** submenu is
CH- selected.

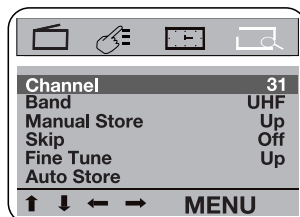

4

VOL+ Press repeatedly to select
Or the **Channel** number.
VOL- Example: to change to
channel number 31.

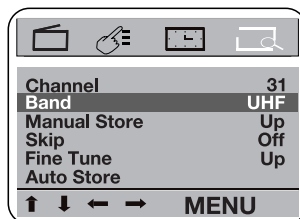

5

CH+ Press repeatedly until
Or **Band** submenu is selected.
CH-

6

VOL+ Select the frequency band
Or (VHFL/VHFH/UHF).
VOL-



TUNING YOUR CHANNELS MANUALLY

Step

Press button

Result on screen

7

CH+ Press repeatedly until
Or **Manual Store** submenu
CH- is selected.

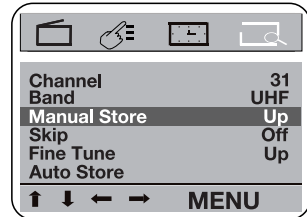

8

VOL+ Press **VOL+** to start
Or search upwards or **VOL-**
VOL- to search downwards
from the current posi-
tion and frequency band.

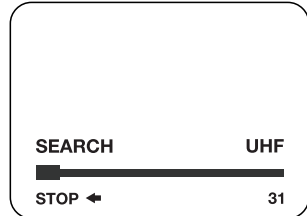

9

VOL+ Press **VOL-** to stop
Or manual searching
VOL- upwards or **VOL+** to
stop manual searching
downwards.

10

MENU Exit menu from screen.

NOTE:

If the channel searched is not the one you want, restart the search upwards or downwards by pressing **VOL+** or **VOL-** respectively.

FINE TUNING YOUR CHANNELS

This feature lets you adjust the picture reception in places where the reception is weak.

Step

Press button

Result on screen

1

MENU Enter main menu.

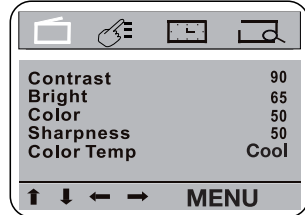

2

VOL+ Or **VOL-** Press repeatedly until the **PRESET** main menu is selected.

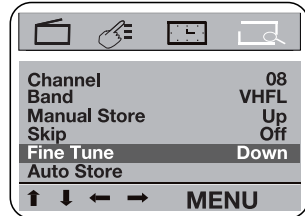

3

CH+ Or **CH-** Press repeatedly until **Fine Tune** submenu is selected.

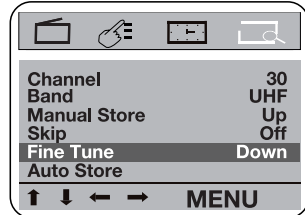

4

VOL+ Or **VOL-** Press **VOL+** to fine tune upwards and **VOL-** to fine tune downwards.

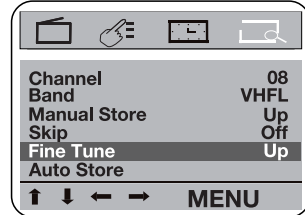

5

MENU Exit menu from screen.

CHANGING THE SYSTEM SETTINGS

The Settings feature lets you set the colour system, sound system and Auto Volume Level (AVL).

AVL enables the volume to remain at a predetermined level to prevent sudden changes in volume levels during commercial breaks or when you are surfing the channels.

Step

Press button

Result on screen

1

MENU Enter main menu.

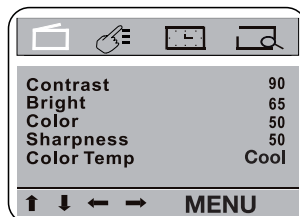

2

VOL+ Or **VOL-** Press repeatedly until the **FEATURE** main menu is selected.

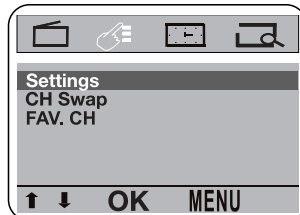

3

CH+ Or **CH-** Press repeatedly until **Settings** submenu is selected.

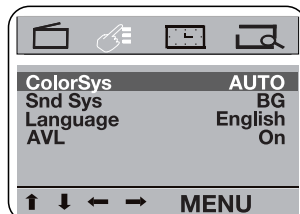

4

OK The **Settings** entries are displayed.

5

CH+ Or **CH-** Press repeatedly to select **ColorSys, Snd Sys** or **AVL**.

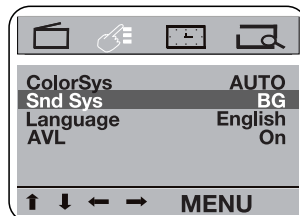

6

VOL+ Or **VOL-** Press repeatedly to change the settings for:
 - **ColorSys (AUTO, PAL, or SECAM)**
 - **Snd Sys (BG, DK or I)**
 - **AVL (On or Off)**

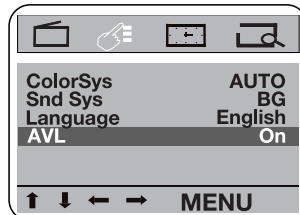

7

MENU Exit menu from screen.

ADJUSTING THE TV PICTURE

The Picture feature lets you fine tune your TV picture such as the contrast, brightness, colour, sharpness and colour temperature.

Step

Press button

Result on screen

1

MENU Enter main menu.

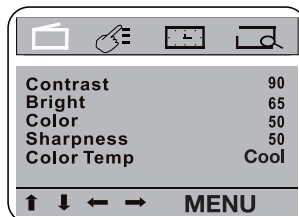

2

VOL+ Press repeatedly until the
Or **PICTURE** main menu is
VOL- selected.

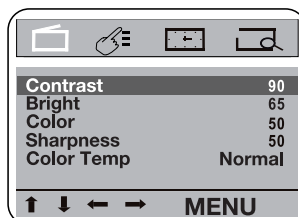

3

CH+ Press repeatedly to select
Or **CH-** **Contrast, Brightness,**
Color, Sharpness or
Color Temp.



4

VOL+ Press to increase or
Or decrease levels for
VOL- **Contrast, Brightness,**
Color and **Sharpness.**

5

VOL+ Press to change settings for
Or **Color Temp (Normal,**
VOL- **Warm or Cool)**

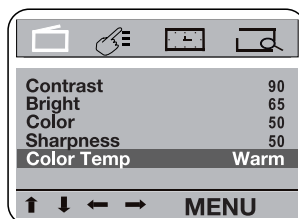



6

MENU Exit menu from screen.

SWAPPING YOUR TV CHANNELS

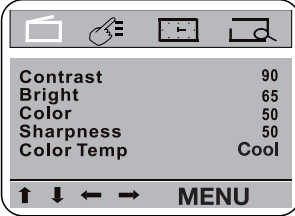
After auto or manual searching of channels, you can reorder the channel numbers using the Channel Swap feature.

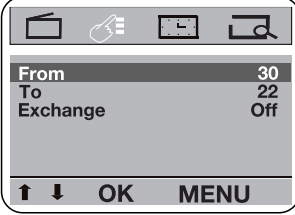
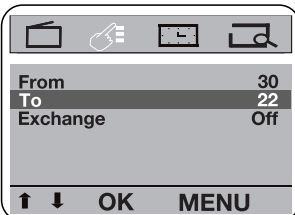
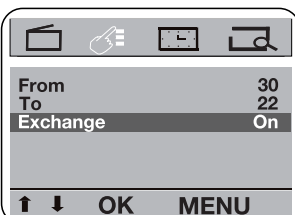
Step	Press button	Result on screen
1	MENU Enter main menu.	
2	VOL+ Press repeatedly until the FEATURE main menu is selected. Or VOL-	
3	CH+ Press repeatedly until CH Swap submenu is selected. Or CH-	
4	OK The CH Swap entries are displayed.	
5	CH+ Press to select From . Or CH-	
6	VOL+ Press to select to select the channel you want to change. Or VOL- Example: Channel 30	
7	CH- Press to select To .	
8	VOL+ Press to select to select the channel you want to swap. Or VOL- Example: Channel 22	
9	CH- Press to select Exchange .	
10	OK Press to select On . Channel 30 is now swapped with channel 22.	
11	MENU Exit menu from screen.	

SKIPPING CHANNELS

This feature lets you skip or edit channels which have bad or weak TV signal.

NOTE:

Once a channel is skipped, you cannot access it by using the CH+ or CH- buttons or the numeric (0 - 9) buttons on the remote control. You will need to restore the skipped channels first.

Step

Press button

Result on screen

1

MENU Enter main menu.

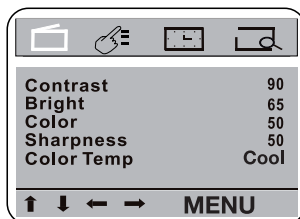

2

VOL+ Press repeatedly until the
Or
VOL- **PRESET** main menu is selected.

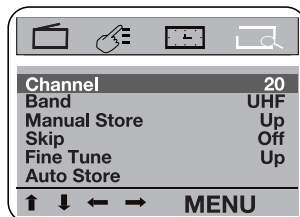

3

CH+ Press repeatedly until
Or
CH- **Channel** submenu is selected.

4

VOL+ Press to select channel
Or
VOL- number to skip.
Example: channel 20.

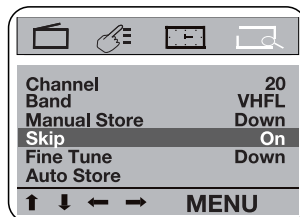

5

CH+ Press repeatedly until
Or
CH- **Skip** submenu is selected.

6

VOL+ Press repeatedly until
Or
VOL- **Skip** is **On**.

7

MENU Exit menu from screen.

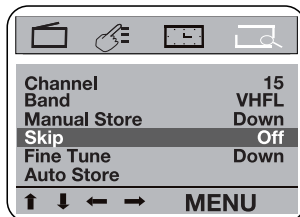

RESTORING SKIPPED CHANNELS

1. Repeat Steps 1 to 5 described above.
2. Press **VOL+** or **VOL-** repeatedly until **Skip** is **Off**. Example: Channel 15 is restored.
3. Press **MENU** to exit.

STORING YOUR FAVOURITE CHANNELS

This feature lets you store up to six favourite channels which you can view or browse using the FAV button on the remote control.

- | Step | Press button | |
|------|----------------------------------|---|
| 1 | MENU | Enter main menu. |
| 2 | VOL+
Or
VOL- | Press repeatedly until the FEATURE main menu is selected. |
| 3 | CH+
Or
CH- | Press repeatedly until FAV. Ch submenu is selected. |
| 4 | OK | The FAV. Ch entries are displayed. |
| 5 | CH+
Or
CH- | Example: To store channel 8 in your favourite channel 1.
Press to select FAV. Ch 1 . |
| 6 | VOL+
Or
VOL- | Press repeatedly until 08 is selected.
Repeat steps 1 to 4 described above to store the other favourite channels. |
| 7 | MENU | Exit menu from screen. |

Result on screen

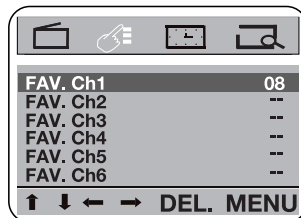
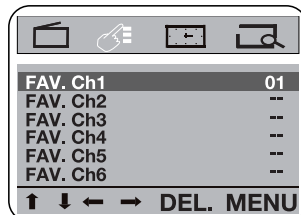
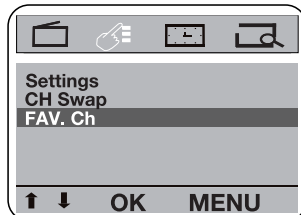
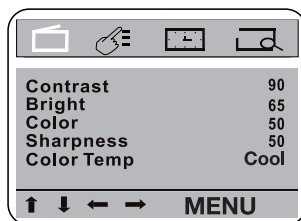

DELETING YOUR FAVOURITE CHANNELS

Example: To delete favourite channel 4:

1. Highlight your favourite channel.
2. Press the DEL button on your remote control to delete the favourite channel.

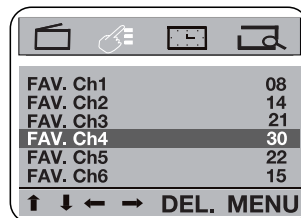

SETTING THE TIMER

The Timer feature lets you program the TV to turn on and turn off at a specific time and channel.

Step

Press button

Result on screen

1

MENU Enter main menu.

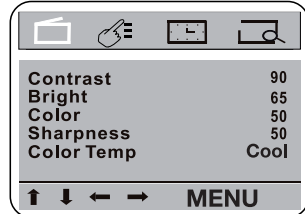

2

VOL+ Or **VOL-** Press repeatedly until the **TIMER** main menu is selected.

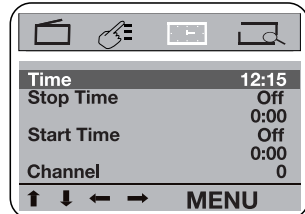

3

VOL+ Or **VOL-** Example: To set time to 18:00 hrs. Press repeatedly until **Time** is 18:00.

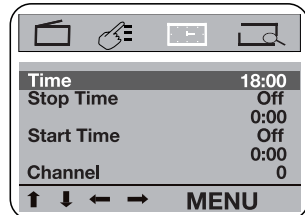

4

CH+ Or **CH-** Example: To set TV to turn off channel 11 at 22:00 hrs everyday. Press repeatedly until **Stop Time** is selected.

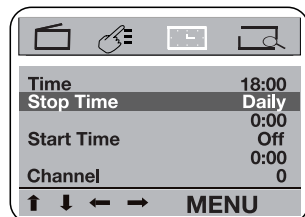

5

VOL+ Or **VOL-** Press repeatedly until **Daily** is selected.

6

CH- Press so that **0:00** is selected.

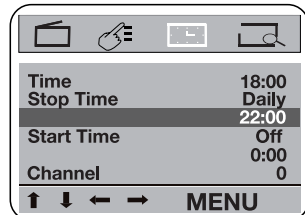

7

VOL+ Or **VOL-** Press repeatedly until **22:00** is selected.

SETTING THE TIMER

Step

Press button

Result on screen

8 **CH+** Example: To set TV to turn on channel 11 at 22:59 hrs once.
 Or
 CH- Press repeatedly until **Start Time** is selected.

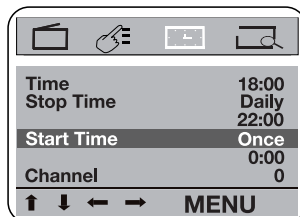

9 **VOL+** Press repeatedly until **Once** is selected.
 Or
 VOL-

10 **CH-** Press so that **0:00** is selected.

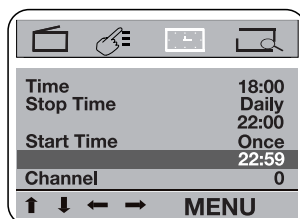

11 **VOL+** Press repeatedly until **22:59** is selected.
 Or
 VOL-

12 **CH-** Press so that **Channel** is selected.

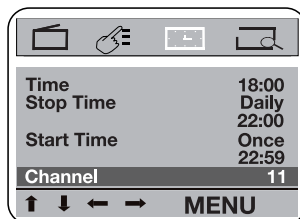

13 **VOL+** Press repeatedly until **Channel** is set to **11**.
 Or
 VOL-

14 **MENU** Exit menu from screen.

NOTE:

You can only enter the **Start Time** using the **VOL+** or **VOL-** buttons. The numeric (0-9) buttons cannot be used to enter **Start Time**.

Off	The Start/Stop Timer will not operate.
Daily	The Start/Stop Timer is set to turn the TV on or off everyday.
Once	The Start/Stop Timer is set to turn the TV on or off only once.
Channel	The channel the TV will display at Start Time.
Stop Time	You should set a time later than that set for Time .

SPECIFICATIONS

Product type	2IPT5007, 2IPT5017, 2IPT5027
Picture	
Display screen type	Real Flat picture tube
Visible diagonal screen size	51 cm
Aspect ratio	4:3
Picture enhancements	Sharpness Adjustment, Black Stretch, Smart Picture
Sound	
Loudspeakers	2 x 5 W 250 W PMPO (/94)
Sound system	Eco AV Stereo
Sound enhancements	Auto Volume Leveller
Convenience	Sleeptimer, Auto Store, Fine Tuning
Reception	
TV system	PAL B/G, PAL D/K, PAL I, SECAM B/G (except /79 and /94), SECAM D/K (except /79 and /94)
Video playback	NTSC, PAL
Connectivity	
Rear	AV1: CVBS In; AV2: Monitor Out; Antenna In (75 Ω)
Side / Top	CVBS in, Headphone out
General	
Mains voltage / frequency	100-240 V, 50/60 Hz (/56 and /94); 220-240 V, 50/60 Hz (/63 /69 and /79)
Power consumption	70 W
Net weight	21.7 kg
Gross weight	25 kg
Set dimensions (W x H x D) mm	594 x 460 x 486

NOTE: Specifications subject to change without notice.



Specifications are subject to change without notice.
Trademarks are the property of Koninklijke Philips Electronics N.V. or their respective owners.
2004 © Koninklijke Philips Electronics N.V. All rights reserved.

www.philips.com
3139 187 57391