

Operating Instructions

50" Class 1080p Plasma HDTV
(49.9 inches measured diagonally)

Manual de instrucciones

Televisión de alta definición de 1080p y
clase 50" de Plasma
(49,9 pulgadas medidas diagonalmente)

For more detailed instructions, refer to the Operating Instructions on the CD-ROM.

To view the Operating Instructions on the CD-ROM, you need a computer equipped with a CD-ROM drive, and Adobe® Reader® (Version 7.0 or later is recommended) installed on your computer. Depending on the operating system or settings on your computer, the Operating Instructions may not start automatically.

In this case, open the PDF file under the "MANUAL" folder manually to view the instructions.

Para obtener instrucciones más detalladas, consulte las instrucciones de manejo contenidas en el CD-ROM.

Para ver las instrucciones de manejo contenidas en el CD-ROM, se necesita un ordenador equipado con una unidad de CD-ROM, y que tenga instalado Adobe® Reader® (se recomienda la versión 7.0 o posterior).

Dependiendo del sistema operativo o de las configuraciones del ordenador, las instrucciones de manejo pueden no iniciarse automáticamente.

En tal caso, abra manualmente el archivo PDF en "MANUAL" carpeta para visualizar las instrucciones.

VIERA

Contents

Please read before using the unit

• Safety Precautions	2
• Note	5
• Accessories/Optional Accessory	6
• Basic Connection	9
• Identifying Controls	11
• First Time Setup	12
• How to Use Menu Functions	15
• FAQ	18
• Limited Warranty (for U.S.A. and Puerto Rico)	20
• Customer Services Directory (for U.S.A. and Puerto Rico)	21
• Limited Warranty (for Canada)	22

For assistance (U.S.A./Puerto Rico), please call: **1-877-95-VIERA (958-4372)** or visit us at www.panasonic.com/contactinfo

For assistance (Canada), please call: **1-866-330-0014** or visit us at www.vieraconcierge.ca

Para solicitar ayuda (EE.UU./Puerto Rico), llame al: **1-877-95-VIERA (958-4372)** ó visítanos en www.panasonic.com/contactinfo

HDMI

HDTV

VIERA Link™

**SD
HG**

**VIERA™
IMAGE VIEWER**

English

Thank you for purchasing this Panasonic product.
Please read these instructions before operating your set and retain them for future reference.
The images shown in this manual are for illustrative purposes only.



Español

Gracias por su decisión de comprar este producto marca Panasonic.
Lea estas instrucciones antes de utilizar su televisor y guárdelas para consultarlas en el futuro.
Las imágenes mostradas en este manual tienen solamente fines ilustrativos.



TQB2AA0574

Safety Precautions

	CAUTION RISK OF ELECTRIC SHOCK DO NOT OPEN	
WARNING: To reduce the risk of electric shock, do not remove cover or back. No user-serviceable parts inside. Refer servicing to qualified service personnel.		



The lightning flash with arrowhead within a triangle is intended to tell the user that parts inside the product are a risk of electric shock to persons.



The exclamation point within a triangle is intended to tell the user that important operating and servicing instructions are in the papers with the appliance.

WARNING: To reduce the risk of fire or electric shock, do not expose this apparatus to rain or moisture. Do not place liquid containers (flower vase, cups, cosmetics, etc.) above the set (including on shelves above, etc.).

Important Safety Instructions

- 1) Read these instructions.
- 2) Keep these instructions.
- 3) Heed all warnings.
- 4) Follow all instructions.
- 5) Do not use this apparatus near water.
- 6) Clean only with dry cloth.
- 7) Do not block any ventilation openings. Install in accordance with the manufacturer's instructions.
- 8) Do not install near any heat sources such as radiators, heat registers, stoves, or other apparatus (including amplifiers) that produce heat.
- 9) Do not defeat the safety purpose of the polarized or grounding-type plug. A polarized plug has two blades with one wider than the other. A grounding type plug has two blades and a third grounding prong. The wide blade or the third prong are provided for your safety. If the provided plug does not fit into your outlet, consult an electrician for replacement of the obsolete outlet.
- 10) Protect the power cord from being walked on or pinched particularly at plugs, convenience receptacles, and the point where they exit from the apparatus.
- 11) Only use attachments / accessories specified by the manufacturer.
- 12) Use only with the cart, stand, tripod, bracket, or table specified by the manufacturer, or sold with the apparatus. When a cart is used, use caution when moving the cart / apparatus combination to avoid injury from tip-over. 
- 13) Unplug this apparatus during lightning storms or when unused for long periods of time.
- 14) Refer all servicing to qualified service personnel. Servicing is required when the apparatus has been damaged in any way, such as power-supply cord or plug is damaged, liquid has been spilled or objects have fallen into the apparatus, the apparatus has been exposed to rain or moisture, does not operate normally, or has been dropped.
- 15) To prevent electric shock, ensure the grounding pin on the AC cord power plug is securely connected.

WARNING/CAUTION



Small parts can present choking hazard if accidentally swallowed.
Keep small parts away from young children. Discard unneeded small parts and other objects, including packaging materials and plastic bags/sheets to prevent them from being played with by young children, creating the potential risk of suffocation.

■ Set up

This Plasma TV may fall and can cause personal injury or even death if not installed correctly. To prevent personal injury or death, follow these warnings:

- **Install the Plasma TV in accordance with the manufacturer's recommended pedestal or stand, corresponding hardware and installation instructions.** This Plasma TV is for use only with the following optional accessories. Use with any other type of optional accessories may cause instability. The following accessories are manufactured by Panasonic Corporation.
 - Wall-hanging bracket (Angled)
TY-WK4P1RW

- **Be sure to ask a qualified technician to carry out the installation and set-up.**
Two or more people are required to install or remove the television.
- **Some wall mounts (wall-hanging brackets) are not designed to be mounted to walls with steel studs or old cinder block constructions.**
Ask your dealer or licensed contractor to properly secure the wall-hanging bracket.
- **Do not route the TV's power cord inside the wall.**
The power cord was not designed for in-wall mounting. Doing so can lead to fire hazard.
- **Do not place the Plasma TV or its stand on a sloped or unstable surface.**
The Plasma TV may fall or tip over.
- **Do not support the Plasma TV on a non-specified pedestal.**
- **Do not place the Plasma TV on furniture that can easily be used as steps, such as a chest of drawers.**
- **Do not climb or allow children to climb on the Plasma TV**
- **Place or install the Plasma TV where it cannot be pushed, pulled over or knocked down.**
- **Route all cords and cables such that they cannot be tripped over or pulled by curious children.**

- **Do not place any objects on top of the Plasma TV.** If water spills onto the Plasma TV or foreign objects get inside it, a short-circuit may occur which could result in fire or electric shock. If any foreign objects get inside the Plasma TV, please consult an Authorized Service Center. In the unlikely event that you receive a shock from this product it is possible that your household outlet may be wired improperly. Have an electrician verify that the TV's outlet is properly wired. If the symptom persists, have the TV serviced by a qualified authorized technician.

■ AC Power Supply Cord

To prevent fire or electric shock:

- **The Plasma TV is designed to operate on a 120 V AC, 60 Hz service. Insert the power cord plug as far as it will go into the wall socket.**
If the plug is not fully inserted, heat may generate, which could cause a fire.
- **The included power cord is for use with this unit only.**
- **Do not use any power cord other than that provided with this TV.**
- **Do not handle the power cord plug with wet hands.**
- **Do not do anything that might damage the power supply cord.**
- **When disconnecting the power supply cord, hold the plug, not the cord.**
- **Do not use the power supply cord if the plug or cord is damaged.**
Replace the cord or contact your Authorized Service Center.
- **Do not use a 3-prong to 2-prong AC plug adaptors to connect your TV's plug to the wall outlet.**
Doing so will defeat the TV plug's safety feature, which can lead to a shock hazard. If the wall outlet does not accommodate a 3-prong plug, have a qualified electrician replace your outlet and check the associated wiring.

■ Handling the power supply cord

- **Insert the power plug fully into the socket outlet. (If the power plug is loose, it could generate heat and cause fire.)**
- **Ensure that the power plug is easily accessible.**
- **Ensure the earth pin on the power plug is securely connected to prevent electrical shock.**
 - An apparatus with CLASS I construction shall be connected to a power socket outlet with a protective earthing connection.
- **Do not touch the power plug with a wet hand. (This may cause electrical shock.)**
- **Do not use any power cord other than that provided with this TV. (This may cause fire or electrical shock.)**
- **Do not damage the power cord. (A damaged cord may cause fire or electrical shock.)**
 - Do not move the TV with the cord plugged in the socket outlet.
 - Do not place a heavy object on the cord or place the cord near a high-temperature object.
 - Do not twist the cord, bend it excessively, or stretch it.
 - Do not pull on the cord. Hold onto the power plug body when disconnecting cord.
 - Do not use a damaged power plug or socket outlet.
- **If a problem occurs (such as no picture or no sound), or if smoke or an abnormal odor is detected from the Plasma TV, unplug the power supply cord immediately.**
Continued use of the TV under these conditions might cause a fire or permanent damage to the TV. Have the TV evaluated by an Authorized Service Center. Servicing of the TV by unauthorized personnel is strongly discouraged due to its high voltage.

- **If water or an object gets inside the Plasma TV, if the Plasma TV is dropped, or if the enclosure becomes damaged, unplug the power supply cord immediately.**
A short-circuit may occur, which could cause a fire. Contact an Authorized Service Center for an evaluation.



- **Do not cover the ventilation holes.**
Doing so may cause the Plasma TV to overheat, which can cause a fire or damage to the Plasma TV.
- **Leave a space of 3 15/16" (10 cm) or more at the top, left and right, and 2 3/4" (7 cm) or more at the rear.**
- **When using the pedestal, keep the space between the bottom of the TV and the pedestal or stand surface clear from objects that may obstruct ventilation.**

■ When Moving the Plasma TV

- **Be sure to disconnect all cables before moving the Plasma TV.**
Moving the TV with its cables attached might damage the cables which, in turn, can cause fire or electric shock.
- **To prevent an electric shock, disconnect the power plug from the wall outlet as a safety precaution before carrying out any cleaning.**
- **Transport only in upright position.**
Transporting the unit with its display panel facing upward or downward may cause damage to the internal circuitry.
- **Using a dry cloth, clean any dust from the power supply cord and plug regularly.**
Build-up of dust on the power cord plug can increase humidity, which might damage the insulation and cause a fire.

This Plasma TV radiates infrared rays;

therefore, it may affect other infrared communication equipment. Install your infrared sensor in a place away from direct or reflected light from your Plasma TV.

The TV will still consume some power as long as the power supply cord is connected to the wall outlet.

- **Display panel is made of glass. Do not apply strong force or impact to the display panel.**
This may cause damage resulting in injury.
- **The TV is heavy. TV should be handled by 2 or more people. Support as shown to avoid injury by the TV tipping or falling.**

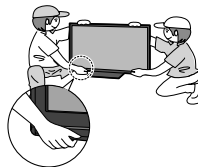

Safety Precautions (Continued)



WARNING

CEA CHILD SAFETY NOTICES: Flat panel displays are not always supported on the proper stands or installed according to the manufacturer's recommendations. Flat panel displays that are inappropriately situated on dressers, bookcases, shelves, desks, speakers, chests or carts may fall over and may cause personal injury or even death.

The consumer electronics industry (of which Panasonic is a member) is committed to making home entertainment enjoyable and safe. To prevent personal injury or death, be sure to follow the following safety guidelines:

TUNE INTO SAFETY:

- One size does NOT fit all. Follow the manufacturer's recommendations for the safe installation and use of your flat panel display.
- Carefully read and understand all enclosed instructions for proper use of this product.
- Don't allow children to climb on or play with furniture and television sets.
- Don't place flat panel displays on furniture that can easily be used as steps, such as a chest of drawers.
- Remember that children can become excited while watching a program, especially on "larger than life" flat panel displays. Care should be taken to install the display where it cannot be pushed, pulled over, or knocked down.
- Care should be taken to route all cords and cables connected to the flat panel display so that they cannot be pulled or grabbed by curious children.

WALL MOUNTING: IF YOU DECIDE TO WALL MOUNT YOUR FLAT PANEL DISPLAY, ALWAYS:

- Use a mount that has been recommended by the display manufacturer and/or listed by an independent laboratory (such as UL, CSA, ETL).
- Follow all instructions supplied by the display and wall mount manufacturers.
- If you have any doubts about your ability to safely install your flat panel display, contact your retailer about professional installation.
- Make sure the wall where you are mounting the display is appropriate. Some wall mounts are not designed to be mounted to walls with steel studs or old cinder block construction. If you are unsure, contact a professional installer.
- A minimum of two people are required for installation. Flat panel displays can be heavy.

Panasonic recommends that a qualified installer perform the wall-mount installation. See page 4.

The American Academy of Pediatrics discourages television viewing for children younger than two years of age.

This product incorporates the following software:

- (1) software developed independently by or for Panasonic Corporation,
- (2) software owned by a third party and licensed to Panasonic Corporation,
- (3) software licensed under the GNU General Public License, Version 2 (GPL v2),
- (4) software licensed under the GNU LESSER General Public License (LGPL) and/or,
- (5) open source software other than software licensed under the GPL and/or LGPL

For the software categorized as (3) or (4), please refer to the terms and conditions of GPL v2 and LGPL, as the case may be. at <http://www.gnu.org/licenses/old-licenses/gpl-2.0.html> and <http://www.gnu.org/licenses/old-licenses/lgpl-2.1.html>

In addition, software categorized as (3) or (4) is copyrighted by several individuals and/or entities. Please refer to the copyright notice of those individuals at <http://www.am-linux.jp/dl/DTV10UT/>.

GPL/LGPL SOFTWARE IS DISTRIBUTED IN THE HOPE THAT IT WILL BE USEFUL, BUT WITHOUT ANY WARRANTY, EXPRESS, IMPLIED OR STATUTORY, INCLUDING THE IMPLIED WARRANTIES OF MERCHANTABILITY OR FITNESS FOR A PARTICULAR PURPOSE.

For at least three (3) years from delivery of products, Panasonic will give to anyone who contacts us at the address provided below, for a charge of no more than our cost of physically performing source code distribution, a complete machine-readable copy of the corresponding source code covered under GPL v2/LGPL.

Contact Information

cdrequest@am-linux.jp

Source code is also freely available to you and any other member of the public via our website below.

<http://www.am-linux.jp/dl/DTV10UT/>

FCC STATEMENT

This equipment has been tested and found to comply with the limits for a Class B digital device, pursuant to Part 15 of the FCC Rules. These limits are designed to provide reasonable protection against harmful interference in a residential installation. This equipment generates, uses and can radiate radio frequency energy and, if not installed and used in accordance with the instructions, may cause harmful interference to radio communications. However, there is no guarantee that interference will not occur in a particular installation. If this equipment does cause harmful interference to radio or television reception, which can be determined by turning the equipment off and on, the user is encouraged to try to correct the interference by one or more of the following measures:

- Reorient or relocate the receiving antenna.
- Increase the separation between the equipment and receiver.
- Connect the equipment into an outlet on a circuit different from that to which the receiver is connected.
- Consult the dealer or an experienced radio/TV technician for help.

This device complies with Part 15 of the FCC Rules. Operation is subject to the following two conditions: (1) This device may not cause harmful interference, and (2) this device must accept any interference received, including interference that may cause undesired operation.

FCC Caution:

To assure continued compliance, follow the attached installation instructions and use only shielded interface cables when connecting to computer or peripheral devices. Any changes or modifications not expressly approved by Panasonic Corp. of North America could void the user's authority to operate this device.

FCC Declaration of Conformity

Model No. TC-50PS24

Responsible Party:	Panasonic Corporation of North America One Panasonic Way, Secaucus, NJ 07094
Contact Source:	Panasonic Consumer Electronics Company 1-877-95-VIERA (958-4372)
email:	consumerproducts@panasonic.com

CANADIAN NOTICE:

For Model TC-50PS24

This Class B digital apparatus complies with Canadian ICES-003.

Notes

■ Do not display a still picture for a long time

This causes the image to remain on the plasma screen

("Image retention"). This is not considered a malfunction and is not covered by the warranty.



To prevent the "Image retention", the screen saver is automatically activated after a few minutes if no signals are sent or no operations are performed.

Typical still images

- Channel number and other logos
- Image displayed in 4:3 mode
- SD Card photo
- Video game
- Computer image

■ Set up

- Do not place the unit where it's exposed to sunlight or other bright light (including reflections).
- Use of some types of fluorescent lighting may reduce the remote control's transmission range.

Accessories/Optional Accessory

Accessories

Check you have all the items shown.

Accessories

- Remote Control Transmitter
 - N2QAYB000485



- Batteries for the Remote Control Transmitter (2)
 - AA Battery



- AC cord

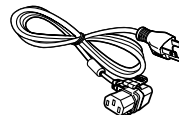

- Operating Instructions (Book)
- Operating Instructions (CD-ROM)
- VIERA Concierge and Quick start guide
- Product Registration Card (U.S.A.)

- Pedestal
 - TBLX0135

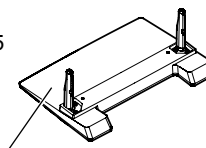

How to assemble (p. 7)

Optional Accessory

Wall-hanging bracket (angle)

- TY-WK4P1RW

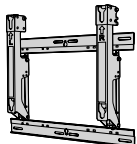

a: 15.7" (400 mm)
b: 11.8" (300 mm)

Please contact your nearest Panasonic dealer to purchase the recommended wall-hanging bracket. For additional details, please refer to the wall-hanging bracket installation manual.

Rear of the TV

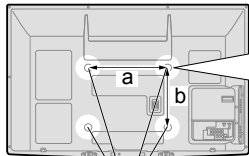

Holes for wall-hanging bracket installation

Screw for fixing the TV onto the wall-hanging bracket (not supplied with the TV)

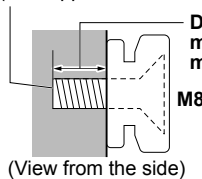

Depth of screw:
minimum 0.59" (15.0 mm),
maximum 1.18" (30.0 mm)

M8

(View from the side)

Warning

- In order to maintain the TV's performance and safety, be absolutely sure to ask your dealer or a licenced contractor to secure the wall-hanging brackets.
- Carefully read the instructions accompanying optional accessories, and be absolutely sure to take steps to prevent the TV from tipping over.
- Handle the TV carefully during installation since subjecting it to impact or other forces may cause product damage.
- Take care when fixing wall brackets to the wall. Always ensure that there are no electrical cables or pipes in the wall before hanging bracket.
- When using the angled-type wall hanging bracket, please ensure that there is sufficient space for the connecting cables not to press against the wall when the TV is tilted forward.
- For safety reasons, remove units no longer being used from their wall-mounted locations.

Installing the remote's batteries

1

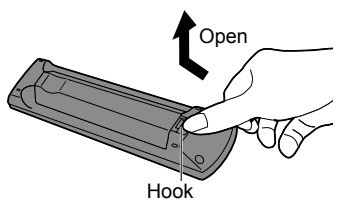

Hook

2

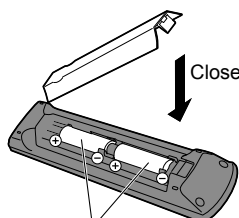

Note the correct polarity (+ or -).

Caution

- Incorrect installation may cause battery leakage and corrosion, resulting in damage to the remote control.
 - Do not mix old and new batteries.
 - Do not mix different battery types (such as alkaline and manganese batteries).
 - Do not use rechargeable (Ni-Cd) batteries.
- Do not burn or break batteries.

Attaching the pedestal to TV

Assembling the pedestal

- Fix securely with assembly screws (A). (Total 4 screws)
- Tighten screws firmly.

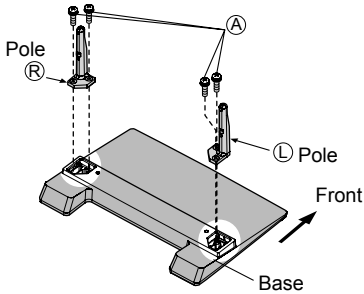

Set-up

- Carry out work on a horizontal and level surface.
- Tighten screws firmly.

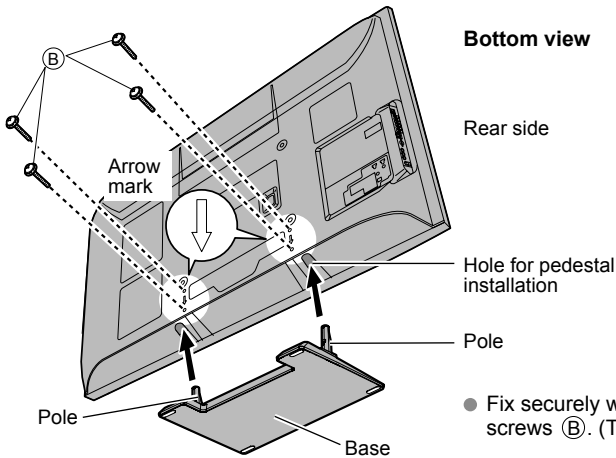

Bottom view

Rear side

Hole for pedestal installation

Pole

- Fix securely with assembly screws (B). (Total 4 screws)

Accessories

Assembly screws
(4 of each)

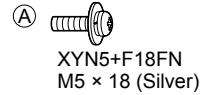

XYN5+F18FN
M5 × 18 (Silver)



THEL080N
M5 × 30 (Black)

Poles (2)

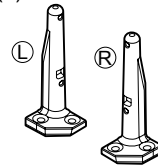

- L or R is printed at the bottom of the poles.

Base (1)

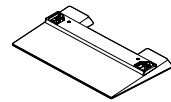

Warning

Do not disassemble or modify the pedestal.

- Otherwise the TV may fall over and become damaged, and personal injury may result.

Caution

Do not use any other TV and displays.

- Otherwise the TV may fall over and become damaged, and personal injury may result.

Do not use the pedestal if it becomes warped or physically damaged.

- If you use the pedestal when it is physically damaged, personal injury may result. Contact your nearest Panasonic Dealer immediately.

During set-up, make sure that all screws are securely tightened.

- If sufficient care is not taken to ensure screws are properly tightened during assembly, the pedestal will not be strong enough to support the TV, and it might fall over and become damaged, and personal injury may result.

Accessories/Optional Accessory (Continued)

AC cord connection

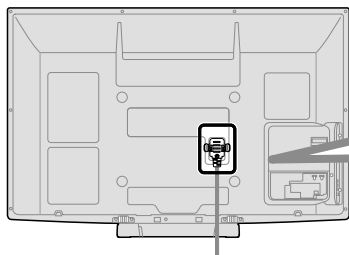

To attach

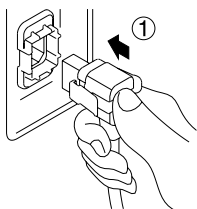

Insert it firmly until the tabs on both sides click into place.

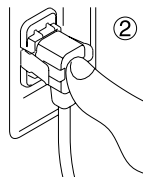

To remove

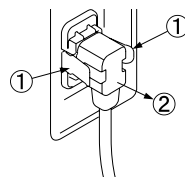

Keep pushing both sides until they snap and pull.

Basic Connection

Example Connecting Antenna (To watch TV)

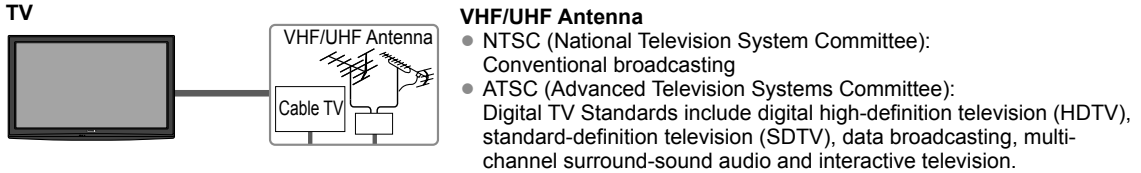

To connect the antenna terminal

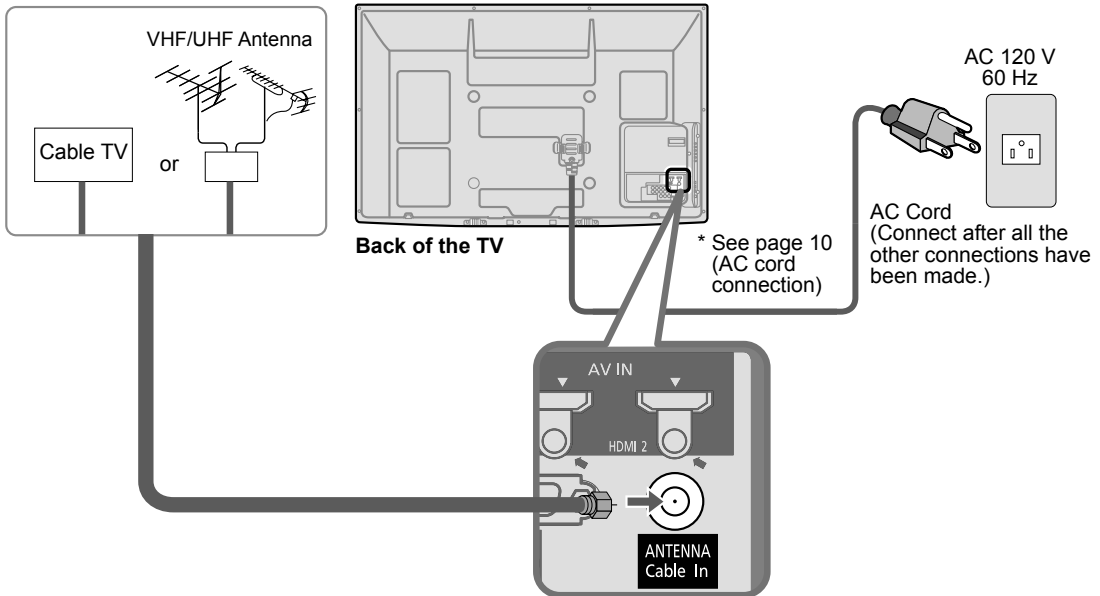

Cable

- You need to subscribe to a cable TV service to enjoy viewing their programming.
- You can enjoy high-definition programming by subscribing to a high-definition cable Service. The connection for high-definition can be done with the use of HDMI or Component Video cable.
- To view high-definition programming select the correct video input.

Note

- Not all cables and external equipment shown in this book are supplied with the TV.
- For more details on the external equipment's connections, please refer to the operating manuals for the equipment.
- When disconnecting the power cord, be absolutely sure to disconnect the power cord plug from the wall outlet first.
- For additional assistance, visit us at: www.panasonic.com
www.panasonic.ca

Basic Connection (Continued)

AV cable connections

High-Definition

A To use HDMI terminals

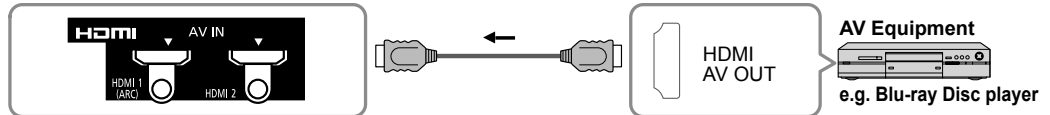

- Connecting to HDMI terminals will enable you to enjoy high-definition digital images and high-quality sound.
- The HDMI connection is required for a 1080p signal.

B To use COMPONENT terminals

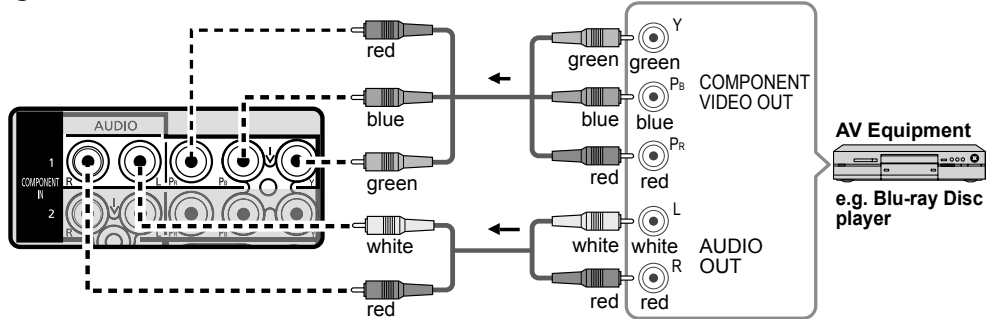

Standard-Definition

C To use COMPOSITE terminals

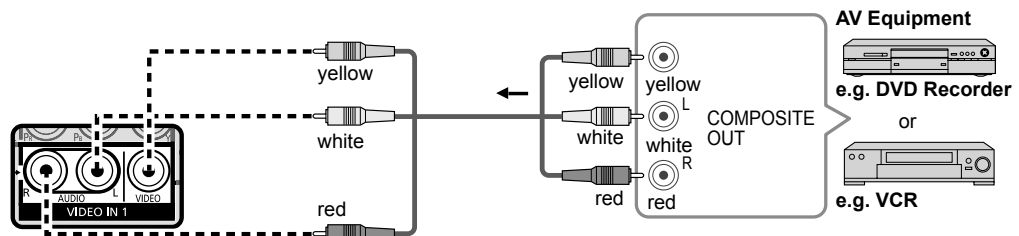

Note

- For more details on the external equipment's connections, please refer to the operating manuals for the equipment.

Identifying Controls

TV controls/indicators

Front of the TV

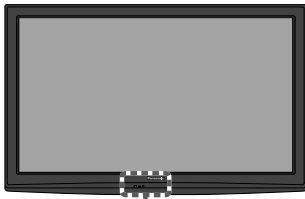

Remote control sensor within about 23 feet (7 meters) in front of the TV set.



Power indicator (on: red, off: no light)

C.A.T.S. sensor
Plasma C.A.T.S. (Contrast Automatic Tracking System)

Back of the TV

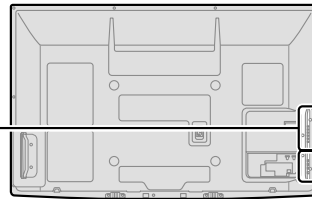

HDMI Input 3 connector

Video Input 2 connector

POWER button

SD card slot

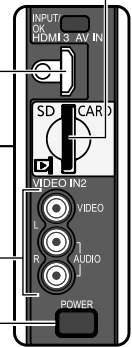

Note

- The TV consumes a small amount of electric energy even when turned off.
- Do not place any objects between the TV remote control sensor and remote control.

Remote control

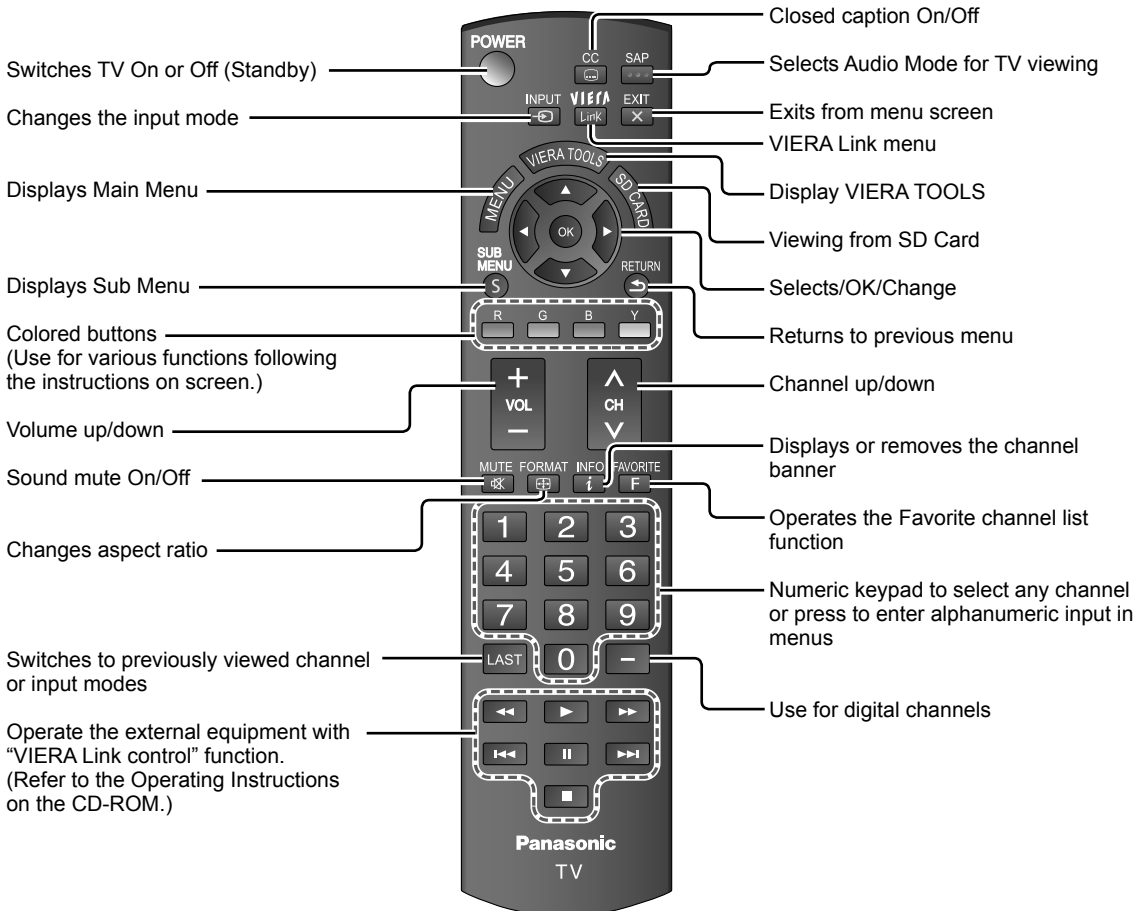

First Time Setup

First time setup screen is displayed only when the TV is turned on for the first time after the power cord is inserted into a wall outlet and when "Auto power on" (p. 17) is set to "No".

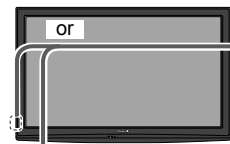

1

Turn the TV On with the POWER button

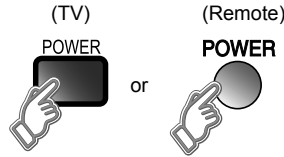

2

Configure your viewing mode

1 Select your language

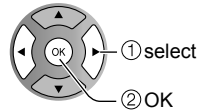

2 Select your viewing mode (Be sure to select "Home use")

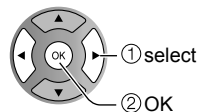
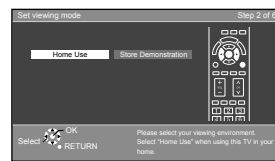

- Please confirm your selection (Home Use) before pressing OK button.

■ If you select "Store Demonstration" by mistake in ②, confirmation screen will be displayed.

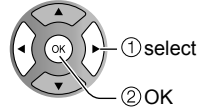
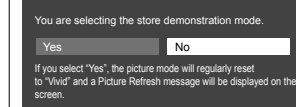

- Select "No" and return to previous screen ②.
- If you select "Yes", Screen enters the store demonstration mode.

To display the "Set viewing mode" screen again as shown above and select "Home Use", do one of the following:

- Press and hold down the side POWER button for at least five seconds.
- Unplug power cord for 30 seconds and plug it again.

Note

- is not available on ② - ①.
- is not available on ②.
- When you have used ② to turn the TV off, the next time you turn the TV on the "Language" settings will be displayed.
- If you use any other step other than ② to turn the TV off, or if you used the EXIT button to quit before completing the settings, the next time you turn the TV on "First time setup" will not be automatically displayed.
 - The settings up to that point are saved.
 - You can reset the settings using "First time setup". (p. 17)
- To change the setting (Language, ANT/Cable setup, Input labels, Clock) later, go to the Menu screen (p. 17)

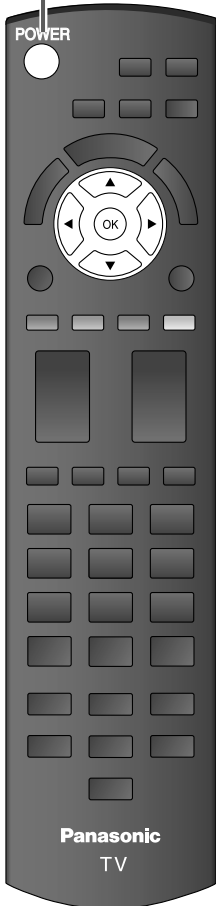

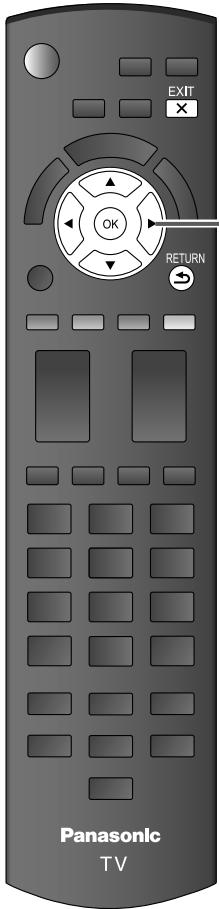

■ Press to return to the previous screen
RETURN



3 Auto channel setup (ANT/Cable setup)

① Select the connected Antenna in terminal

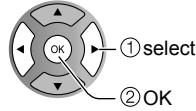
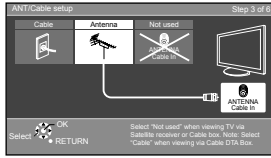

Not used: Go to ④
(Label inputs)

Select "Not used" when no wire is connected to the "Antenna/Cable" terminal.

- Typical when a Cable/Satellite box is connected to a TV input.
- Prevents accidental tuning to an unavailable signal.

② Select "Start"

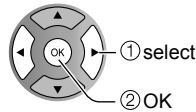
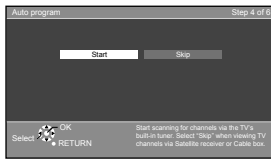

Skip: Go to ④
(Label inputs)

Start scanning the channels

(Available channels are automatically set.)

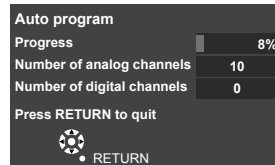

③ Complete the Auto program setup

Completion message is displayed when the Auto program scan is successfully completed.

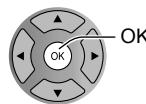
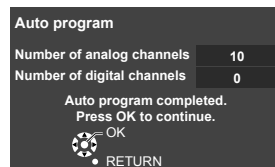

If there is no available channel, return to ③ - ① (ANT/ Cable setup). "Not used" will be selected.

■ Operation of the EXIT button during "First time setup"

Press the button once to display confirmation screen. Press again to close confirmation screen.

[EXIT confirmation screen]

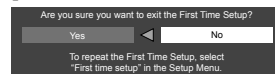

Yes ➔ Exit "First time setup"
No ➔ Return to the original screen.

First Time Setup (Continued)

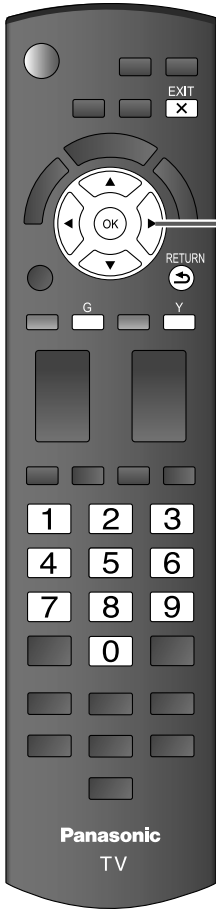

4 Select the Input labels (Label inputs)

Select NEXT then press OK to go to next step.

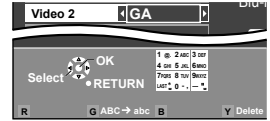
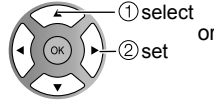
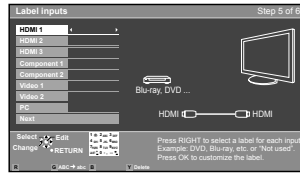

Follow the instructions on screen to complete the following operations.

Label: [BLANK] Not used/Blu-ray/DVD/DVD REC/HOME THTR/GAME/COMPUTER/VCR/CABLE/SATELLITE/DVR/CAMERA/MONITOR/AUX/RECEIVER/MEDIA CTR/MEDIA EXT/OTHER

5 Adjust the Clock (Set clock)

Select NEXT then press OK to go to next step.

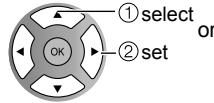

Follow the instructions on screen to complete the following operations.

6 Complete the First time setup

Completion message is displayed when you successfully completed the First time setup.

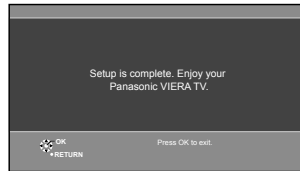

- Note**
- About broadcasting systems
 - Analog (NTSC):** Conventional broadcasting
 - Digital (ATSC):** New programming that allows you to view more channels featuring high-quality video and sound

How to Use Menu Functions

Various menus allow you to make settings for the picture, sound, and other functions so that you can enjoy watching TV best suited for you.

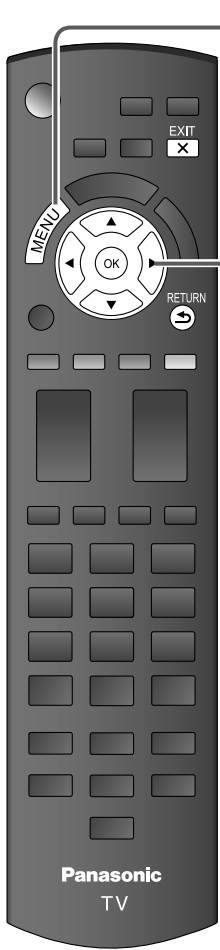

1 Display the menu



- Shows the functions that can be adjusted.
- Some functions will be disabled depending on the type of input signal.

Menu structure

Menu bar
Press OK to move to the Menu items.

Menu items
Press OK to proceed to next screen if available.

Help information
Select or enter the name of the device connected to the HDMI 1 terminal.

Operation guide

(example: Input labels)

2 Select the menu

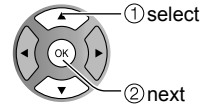

3 Select the item

(example: Picture menu)

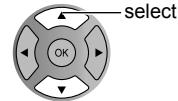

■ Press to exit from a menu screen



■ Press to return to the previous screen



4 Adjust or select

(example: Picture menu)

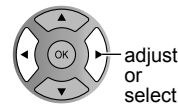

How to Use Menu Functions

■ Menu list

Menu	Item	Adjustments/Configurations (alternatives)	
Picture	Reset to defaults*	Resets all picture adjustments to factory default settings except for "Advanced picture".	
	Picture mode	Basic picture mode (Vivid/Standard/Cinema/Custom)	
	Contrast, Brightness, Color, Tint, Sharpness	Adjusts the color, brightness, etc. for each picture mode to suit your taste ● Display range Contrast/Brightness/Color/Sharpness: 0 - 100 Tint: -50 - +50	
	Color temp.	Selects a choice of Cool (blue), Normal, or Warm (red) color. (Cool/Normal/Warm)	
	x.v.Color	Auto: Provides the appropriate picture when images corresponding to "x.v.Color" are input via the HDMI input of this TV. (Off/Auto)	
	C.A.T.S.	Adjusts the brightness and gradation according to the ambient lighting condition. (Off/On)	
	Video NR	Reduces noise, commonly called snow. Leave it off when receiving a strong signal. (Off/On)	
	Aspect adjustments	Screen format	Changes the format (aspect ratio). (FULL/H-FILL/JUST/4:3/ZOOM) Lets you choose the aspect depending on the format of received signal.
		HD size	Selects between 95 % (Size 1) or 100 % (Size 2) for the scanning area with High-definition signal. (Size 1/Size 2) Select "Size 1" if noise is generated on the edges of the screen. ● Size 1: Selected item for "HD size". Scanning 95 % ● Size 2: Selected item for "HD size". Scanning 100 %
		H size	Adjusts the horizontal display range to reduce noise of both side edges of an image. (Size 1/Size 2) Size 2: Adjusts the image size according to the aspect mode to reduce noise.
		Zoom adjustments	Adjusts vertical alignment and size when aspect setting is "ZOOM"
	PC adjustments	Set PC display	
	Advanced picture	3D Y/C filter	Minimizes noise and cross-color in the picture. (Off/On)
		Color matrix	Selects image resolution of component-connected devices (SD/HD) ● SD: Standard Definition HD: High Definition ● Only used with 480p video signal.
MPEG NR		Reduces noise of specific digital signals of DVD, STB, etc. (Off/On)	
Black level		Selects Dark or Light. Valid only for external input signals. (Dark/Light)	
3:2 pulldown		Adjusts the picture recorded in 24 fps for optimum quality. (Off/On/Auto)	
Audio	Reset to defaults*	Resets Bass, Treble, and Balance adjustments to factory default settings.	
	Bass	Increases or decreases the bass response.	
	Treble	Increases or decreases the treble response.	
	Balance	Emphasizes the left / right speaker volume.	
	Advanced audio	Surround	Enhances audio response when listening to stereo. (Off/On)
		Volume leveler	Minimizes volume disparity after switching to external inputs.
TV speakers		Switches to "Off" when using external speakers (Off/On) ● "Surround" and "Volume leveler" do not work if "Off" is selected.	
HDMI 1 in HDMI 2 in HDMI 3 in	The default setting is "Digital" for the HDMI connection. (Digital input signal) Select audio input terminal when DVI cable is connected. (Analog audio input signal) (Digital/Component 1/Component 2/Video 1/Video 2)		
Timer	Sleep, Timer 1-5	The TV can automatically turn On/Off at the designated date and time.	
Lock		Locks the channels and programs.	
Closed caption	Closed caption	Displays subtitles (Closed caption)	

● In the AV mode, the Audio and Setup menus give fewer options.

* Confirmation screen is displayed. Select "Yes" and press OK to reset.

(Continued)

■ Menu list

Menu	Item	Adjustments/Configurations (alternatives)	
Setup	Channel surf mode	Sets the mode to select the channel with the Channel up/down button. (All/Favorite/Digital only/Analog only) ● Favorite: Only channels registered as FAVORITE.	
	Language	Selects the screen menu language.	
	Clock	Adjusts the clock.	
	ANT/Cable setup	Sets channels.	
	Input labels	Selects the terminal and label of the external equipment.	
	Anti Image retention	Pixel orbiter	Prevents "Image retention" with Wobbling. (Automatic/Periodic) ● Automatic: Shifts the display image automatically. ● Periodic: Shifts the display image every (1/2/3/4) minutes according to what was set in the "Time (minutes)" menu.
		Time (minutes)	Sets the time for the "Pixel orbiter-Periodic" setting. (1/2/3/4)
		4:3 side bars	Changes the brightness of the side bar (Off/Dark/Mid/Bright) (4:3 mode only) ● The recommended setting is "Bright" to prevent the panel "Image retention".
		Scrolling bar	Press "OK" to start the horizontal "Scrolling" on the screen.
	VIERA Link settings	VIERA Link	Controls the equipment connected to HDMI terminals. (Off/On) ● "Power off link", "Power on link", "Energy saving mode", "Unselected device energy save" and "Default speakers" cannot be selected if "Off" is set.
		Power on link	Sets "Power on link" of the HDMI connected equipment. (No/Yes)
		Power off link	Sets "Power off link" of the HDMI connected equipment. (No/Yes)
		Energy saving mode	Sets "Energy saving mode" of the HDMI connected equipment. (Quick start/Save)
		Unselected device energy save	Sets "Unselected device energy save" of the HDMI connected equipment. (No (stay on)/Yes (with prompt)/Yes (no prompt))
		Default speakers	Selects the default speakers. (TV/Theater)
	ECO/energy saving	No signal for 10 minutes	To conserve energy, the TV automatically turns off when NO SIGNAL and NO OPERATION continue for more than 10 minutes. (Stay on/Power TV off) Note ● Not in use when "Auto power on", "On/Off Timer" or "Lock" is set, or while "SD mode" or "Digital Channel" is selected. ● "No signal for 10 minutes was activated" will be displayed for about 10 seconds when the TV is turned on for the first time after the power was turned off by "No signal for 10 minutes". ● The on-screen display will flash 3, 2 and 1 to indicate the last three (3) remaining minutes prior to the shut-off.
		No activity for 3 hours	To conserve energy, the TV automatically turns off when no operation of remote and side panel key continues for more than 3 hours. (Stay on/Power TV off) Note ● Not in use when "Auto power on" or "On/Off Timer" is set, or while "PC input" is selected. ● "No activity for 3 hours was activated" will be displayed for about 10 seconds when the TV is turned on for the first time after the power was turned off by "No activity for 3 hours". ● The on-screen display will flash 3, 2 and 1 to indicate the last three (3) remaining minutes prior to the shut-off.
	Advanced setup	Auto power on	Turns TV On automatically when the cable box or connected device is turned On (No/Yes) TV AC cord must be plugged into this device. TV turns on every time the power is restored. ● The "Sleep" timer, "On / Off timer", and "First time setup" will not function if "Auto power on" is set.
		Image viewer auto play	Sets the "Thumbnail" or "Slideshow" to play back SD cards automatically. (Slideshow/Thumbnail/Set later/Off)
		First time setup	Restarts the first time setup from "Language" setting.
		About	Displays TV version and software license.
	Reset to defaults	Performing Reset will clear all settings made with Setup, such as channel settings.	

■ Sub menu list

Menu	Item	Adjustments/Configurations (alternatives)
Setup SUB MENU	Channel surf mode	Sets the mode to select the channel with the Channel up/down button. (All/Favorite/Digital only/Analog only)
	Set favorite	Sets favorite channels.
	Edit CH caption	Changes the station identifier.
	Signal meter	Checks the signal strength if interference or freezing occurs on a digital image.

FAQ

Before requesting service or assistance, please follow these simple guides to resolve the problem.

If the problem still persists, please contact your local Panasonic dealer or Panasonic Service Center for assistance. For details

For additional assistance, please contact us via the website at:

www.panasonic.com/contactinfo

www.panasonic.ca

White spots or shadow images (noise)

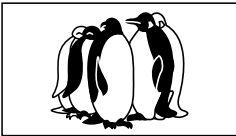
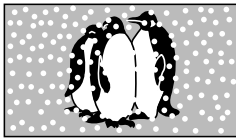

- Check the position, direction, and connection of the antenna.

Interference or frozen digital channels (intermittent sound)

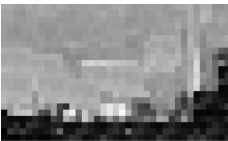

- Change the direction of antenna for digital channels.
- Check "Signal meter". If the signal is weak, check the antenna and consult your local dealer.

The remote control does not work

- Are the batteries installed correctly?
- Are the batteries new?

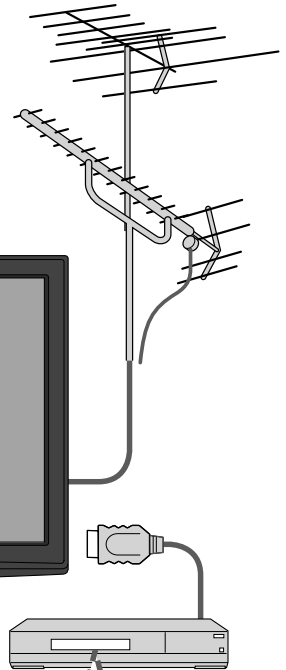

Pictures from external equipment are distorted when the unit is connected via HDMI

- Is the HDMI cable connected properly?
- Turn Off the TV unit and equipment, then turn them On again.
- Check an input signal from the equipment.
- Use equipment compliant with EIA/CEA-861/861B.

When the channel is changed on an STB that is connected with HDMI, "HDMI" may be displayed on the top left of the screen

- This is not a malfunction.

Recording does not start immediately

- Check the settings of the recorder. For details, read the manual of the recorder.

If there is a problem with your TV, please refer to the table below to determine the symptoms, then carry out the suggested check. If this does not solve the problem, please contact your local Panasonic dealer, quoting the model number and serial number (both found on the rear of the TV).

	Problem	Actions
Screen	“VIERA” logo moves on the screen	<ul style="list-style-type: none"> ● The function to prevent “Image retention” is activated. (Not a faulty symptom) <ul style="list-style-type: none"> ● The screen saver is activated if the TV unit is not operated for a certain time in SD mode. ● “Image retention”
	Some spots remain bright or dark	<ul style="list-style-type: none"> ● The Plasma panel is made up of a few million pixels and is produced with advanced technology through an intricate process. Sometimes a few pixels may be bright or dark. These pixels do not indicate a defective panel and will have no impact on the performance of the TV.
	Chaotic image, noisy	<ul style="list-style-type: none"> ● Check nearby electrical products. (car or motorcycle ignition systems, fluorescent lamp, etc.)
	No image is displayed on screen	<ul style="list-style-type: none"> ● Check Picture menu ● Check the cable connections. ● Check that the correct input has been selected.
	Only spots are displayed instead of images	<ul style="list-style-type: none"> ● Check the channel settings. ● Check the antenna cables.
	Neither image nor sound is produced	<ul style="list-style-type: none"> ● Is the AC power cord plugged into the outlet? ● Is the TV unit turned On? ● Check Picture menu and volume. ● Check the AV cable connections. ● Check that the correct input has been selected.
Sound	Black Box appears	<ul style="list-style-type: none"> ● Change settings of Closed Caption (CC).
	No sound is produced	<ul style="list-style-type: none"> ● Are the speakers’ cables connected correctly? ● Is “Sound Mute” active? ● Is the volume set to the minimum? ● Is “TV speakers” set to “Off”? ● Change “SAP” settings. ● Check “HDMI 1 in”, “HDMI 2 in” or “HDMI 3 in” settings.
	Sound is unusual	<ul style="list-style-type: none"> ● Set “SAP” setting to “Stereo” or “Mono”. ● Check the HDMI device connected to the unit. ● Set the audio setting of the HDMI device to “Linear PCM”. ● If digital sound connection has a problem, select analog sound connection.
	Unknown sound heard 1- Sounds from TV cabinet 2- Tick/Click sound 3- Buzzing sound	<ol style="list-style-type: none"> 1- Changes in the temperature and humidity of the room may cause the TV’s cabinet to expand or contract and produce metallic sounds. This is not a sign of faulty operation or a malfunction. 2- When the TV is powered on, an electrical component in the TV activates producing a tick/click sound. This is not a sign of faulty operation or a malfunction. 3- Electrical circuits are active while the TV set is on. This is not a sign of faulty operation or a malfunction.
	Parts of the TV set become hot	<ul style="list-style-type: none"> ● Even when the temperature of parts of the front, top and rear panels has risen, these temperature rises will not pose any problems in terms of performance or quality.
TV set		

Limited Warranty (for U.S.A. and Puerto Rico only)

PANASONIC CONSUMER ELECTRONICS COMPANY,
DIVISION OF
PANASONIC CORPORATION OF NORTH AMERICA
One Panasonic Way
Secaucus, New Jersey 07094

Panasonic Plasma Television Limited Warranty

Limited Warranty Coverage

If your product does not work properly because of a defect in materials or workmanship, Panasonic Consumer Electronics Company (referred to as "the warrantor") will, for the length of the period indicated on the chart below, which starts with the date of original purchase ("Limited Warranty period"), at its option either (a) repair your product with new or refurbished parts, (b) replace it with a new or a refurbished equivalent value product, or (c) refund your purchase price. The decision to repair, replace or refund will be made by the warrantor.

PLASMA TV CATEGORIES	PARTS	LABOR	SERVICE
Up to 42" (diagonal)	1 (ONE) YEAR	1 (ONE) YEAR	Carry-In
46" (diagonal) and larger			On-Site

During the "Labor" Limited Warranty period there will be no charge for labor. During the "Parts" Limited Warranty period, there will be no charge for parts.

You must carry-in your product or arrange for on-site service during the Limited Warranty period. If non-rechargeable batteries are included, they are not warranted. This Limited Warranty only applies to products purchased and serviced in the United States or Puerto Rico. This Limited Warranty is extended only to the original purchaser of a new product which was not sold "as is". A purchase receipt or other proof of the original purchase date is required for Limited Warranty service.

On-Site or Carry-in Service

For On-Site or Carry-In Service in the United States and Puerto Rico call 1-877-95-VIERA (1-877-958-4372).

On-site service where applicable requires clear, complete and easy access to the product by the authorized servicer and does not include removal or re-installation of an installed product. It is possible that certain on-site repairs will not be completed on-site, but will require that the product or parts of the product, at the servicer's discretion be removed for shop diagnosis and/or repair and then returned.

Limited Warranty Limits And Exclusions

This Limited Warranty ONLY COVERS failures due to defects in materials or workmanship, and DOES NOT COVER normal wear and tear or cosmetic damage, nor does it cover markings or retained images on the glass panel resulting from viewing fixed images (including, among other things, non-expanded standard 4:3 pictures on wide screen TV's, or onscreen data in a stationary and fixed location). The Limited Warranty ALSO DOES NOT COVER damages which occurred in shipment, or failures which are caused by products not supplied by the warrantor, or failures which result from accidents, misuse, abuse, neglect, bug infestation, mishandling, misapplication, alteration, faulty installation, set-up adjustments, misadjustment of consumer controls, improper maintenance, power line surge, lightning damage, modification, or commercial use (such as in a hotel, office, restaurant, or other business), rental use of the product, service by anyone other than a Factory Service Center or other Authorized Servicer, or damage that is attributable to acts of God.

THERE ARE NO EXPRESS WARRANTIES EXCEPT AS LISTED UNDER "LIMITED WARRANTY COVERAGE". THE WARRANTOR IS NOT LIABLE FOR INCIDENTAL OR CONSEQUENTIAL DAMAGES RESULTING FROM THE USE OF THIS PRODUCT, OR ARISING OUT OF ANY BREACH OF THIS LIMITED WARRANTY. (As examples, this excludes damages for lost time, cost of having someone remove or re-install an installed unit if applicable, or travel to and from the servicer. The items listed are not exclusive, but are for illustration only.) **ALL EXPRESS AND IMPLIED WARRANTIES, INCLUDING THE LIMITED WARRANTY OF MERCHANTABILITY, ARE LIMITED TO THE PERIOD OF THE LIMITED WARRANTY.**

Some states do not allow the exclusion or limitation of incidental or consequential damages, or limitations on how long an implied Limited Warranty lasts, so the exclusions may not apply to you.

This Limited Warranty gives you specific legal rights and you may also have others rights which vary from state to state. If a problem with this product develops during or after the Limited Warranty period, you may contact your dealer or Service Center. If the problem is not handled to your satisfaction, then write to the warrantor's Consumer Affairs Department at the addresses listed for the warrantor.

PARTS AND SERVICE (INCLUDING COST OF AN ON-SITE SERVICE CALL, WHERE APPLICABLE) WHICH ARE NOT COVERED BY THIS LIMITED WARRANTY ARE YOUR RESPONSIBILITY.

Customer Services Directory (for U.S.A. and Puerto Rico)

Customer Services Directory (United States and Puerto Rico)

Obtain Product Information and Operating Assistance; locate your nearest Dealer or Service Center; purchase Parts and Accessories; or make Customer Service and Literature requests by visiting our Web Site at:

[**http://www.panasonic.com/help**](http://www.panasonic.com/help)

or, contact us via the web at:

[**http://www.panasonic.com/contactinfo**](http://www.panasonic.com/contactinfo)

You may also contact us directly at:

1-877-95-VIERA (958-4372)

Monday-Friday 9 am-9 pm; Saturday-Sunday 10 am-7 pm, EST.

■ For hearing or speech impaired TTY users, TTY: 1-877-833-8855

Accessory Purchases (United States and Puerto Rico)

Purchase Parts, Accessories and Instruction Books on line for all Panasonic Products by visiting our Web Site at:

[**http://www.pstc.panasonic.com**](http://www.pstc.panasonic.com)

or, send your request by E-mail to:

[**npcparts@us.panasonic.com**](mailto:npcparts@us.panasonic.com)

You may also contact us directly at:

1-800-332-5368 (Phone) 1-800-237-9080 (Fax Only) (Monday - Friday 9 am to 9 pm, EST.)

Panasonic Service and Technology Company

20421 84th Avenue South,

Kent, WA 98032

(We Accept Visa, MasterCard, Discover Card, American Express, and Personal Checks)

■ For hearing or speech impaired TTY users, TTY: 1-866-605-1277

Limited Warranty (for Canada)

Panasonic Canada Inc.
5770 Ambler Drive, Mississauga, Ontario L4W 2T3
PANASONIC PRODUCT – LIMITED WARRANTY

Panasonic Canada Inc. warrants this product to be free from defects in material and workmanship under normal use and for a period as stated below from the date of original purchase agrees to, at its option either (a) repair your product with new or refurbished parts, (b) replace it with a new or a refurbished equivalent value product, or (c) refund your purchase price. The decision to repair, replace or refund will be made by Panasonic Canada Inc.

Viera TV (42" & over)	In-home service	One (1) year, parts (including panel) and labour.
Viera TV (under 42")	Carry-in service	One (1) year, parts (including panel) and labour.

In-home Service will be carried out only to locations accessible by roads and within 50 km of an authorized Panasonic service facility.

In-home service requires clear, complete and easy access to the product by the Authorized Servicer and does not include removal or re-installation of an installed product. If removal is required to service the product, it will be at the discretion of the Servicer and in no event will Panasonic Canada Inc. or the Servicer be liable for any special, indirect or consequential damages.

This warranty is given only to the original purchaser, or the person for whom it was purchased as a gift, of a Panasonic brand product mentioned above sold by an authorized Panasonic dealer in Canada and purchased and used in Canada, which product was not sold "as is", and which product was delivered to you in new condition in the original packaging.

IN ORDER TO BE ELIGIBLE TO RECEIVE WARRANTY SERVICE HEREUNDER, A PURCHASE RECEIPT OR OTHER PROOF OF DATE OF ORIGINAL PURCHASE, SHOWING AMOUNT PAID AND PLACE OF PURCHASE IS REQUIRED

LIMITATIONS AND EXCLUSIONS

This warranty **ONLY COVERS** failures due to defects in materials or workmanship, and **DOES NOT COVER** normal wear and tear or cosmetic damage. The warranty **ALSO DOES NOT COVER** damages which occurred in shipment, or failures which are caused by products not supplied by Panasonic Canada Inc., or failures which result from accidents, misuse, abuse, neglect, mishandling, misapplication, alteration, faulty installation, set-up adjustments, misadjustment of consumer controls, improper maintenance, power line surge, lightning damage, modification, introduction of sand, humidity or liquids, commercial use such as hotel, office, restaurant, or other business or rental use of the product, or service by anyone other than a Authorized Servicer, or damage that is attributable to acts of God. Dry cell batteries are also excluded from coverage under this warranty.

THIS EXPRESS, LIMITED WARRANTY IS IN LIEU OF ALL OTHER WARRANTIES, EXPRESS OR IMPLIED, INCLUDING ANY IMPLIED WARRANTIES OF MERCHANTABILITY AND FITNESS FOR A PARTICULAR PURPOSE. IN NO EVENT WILL PANASONIC CANADA INC. BE LIABLE FOR ANY SPECIAL, INDIRECT OR CONSEQUENTIAL DAMAGES RESULTING FROM THE USE OF THIS PRODUCT OR ARISING OUT OF ANY BREACH OF ANY EXPRESS OR IMPLIED WARRANTY. (As examples, this warranty excludes damages for lost time, travel to and from the Authorized Servicer, loss of or damage to media or images, data or other memory or recorded content. This list of items is not exhaustive, but for illustration only.)

In certain instances, some jurisdictions do not allow the exclusion or limitation of incidental or consequential damages, or the exclusion of implied warranties, so the above limitations and exclusions may not be applicable. This warranty gives you specific legal rights and you may have other rights which vary depending on your province or territory.

WARRANTY SERVICE

For product operation and information assistance, please contact:

Our Customer Care Centre: 1-800 #: 1-866-330-0014
Email link: "Contact us → email" on www.vieraconcierge.ca

For product repairs, please contact Viera Customer Care Agent using the above contact info.

IF YOU SHIP THE PRODUCT TO A SERVICENTRE

Carefully pack and send prepaid, adequately insured and preferably in the original carton.
Include details of the defect claimed, and proof of date of original purchase.

A series of horizontal dashed lines for writing notes.

Customer's Record

The model number and serial number of this product can be found on its back cover. You should note this serial number in the space provided below and retain this book, plus your purchase receipt, as a permanent record of your purchase to aid in identification in the event of theft or loss, and for Warranty Service purposes.

Model Number _____

Serial Number _____

Anotación del cliente

El modelo y el número de serie de este producto se encuentran en su panel posterior. Deberá anotarlos en el espacio provisto a continuación y guardar este manual, más el recibo de su compra, como prueba permanente de su adquisición, para que le sirva de ayuda al identificarlo en el caso de que le sea sustraído o lo pierda, y también para disponer de los servicios que le ofrece la garantía.

Modelo _____

Número de serie _____

Panasonic Consumer Electronics Company,
Division of Panasonic Corporation of North America
One Panasonic Way, Secaucus
New Jersey 07094 U.S.A.

Panasonic Canada Inc.
5770 Ambler Drive
Mississauga, Ontario
L4W 2T3 CANADA