



Panasonic®

Operating Instructions LCD Television

Model No. **TC-20LA5**
TC-20LE5



LCD TV shown above is model TC-20LA5.

For assistance, please call : 1-800-211-PANA (7262) or visit us at www.panasonic.com/contactinfo	(U.S.A.)
For assistance, please call : 787-750-4300 or visit us at www.panasonic.com	(Puerto Rico)
For assistance, please call : 1-800-561-5505 or visit us at www.panasonic.ca	(Canada)

Before connecting, operating or adjusting this product, please read these instructions completely.
Please keep this manual for future reference.

English

Español [Resumen]

Important Safety Instructions



The lightning flash with arrow head within a triangle is intended to tell the user that parts inside the product are a risk of electric shock to persons.



The exclamation point within a triangle is intended to tell the user that important operating and servicing instructions are in the papers with the appliance.

- **Note to CATV System Installer:** This reminder is provided to direct the CATV system installer's attention to Article 820-40 of the NEC that provides guidelines for proper grounding and, in particular, specifies that the cable ground shall be connected to the grounding system of the building, as close to the point of cable entry as practical.

■ Secure ventilation

Slots and openings in the cabinet and the back or bottom are provided for ventilation, and to ensure reliable operation of the LCD TV and to protect it from overheating. These openings must not be blocked or covered. There should be at least 10 cm of space from these openings. The openings should never be blocked by placing the LCD TV on a bed, sofa, rug or other similar surface. This LCD TV should not be placed in a built-in installation such as a bookcase unless proper ventilation is provided.

■ Important Safety Instructions for LCD TV

- 1) Read these instructions.
- 2) Keep these instructions.
- 3) Heed all warnings.
- 4) Follow all instructions.
- 5) Do not use this apparatus near water.
- 6) Clean only with dry cloth.
- 7) Do not block any ventilation openings. Install in accordance with the manufacturer's instructions.
- 8) Do not install near any heat sources such as radiators, heat registers, stoves, or other apparatus (including amplifiers) that produce heat.
- 9) Do not defeat the safety purpose of the polarized or grounding-type plug. A polarized plug has two blades with one wider than the other. A grounding type plug has two blades and a third grounding prong. The wide blade or the third prong are provided for your safety. If the provided plug does not fit into your outlet, consult an electrician for replacement of the obsolete outlet.
- 10) Protect the power cord from being walked on or pinched particularly at plugs, convenience receptacles, and the point where they exit from the apparatus.
- 11) Only use attachments / accessories specified by the manufacturer.
- 12) Use only with the cart, stand, tripod, bracket, or table specified by the manufacturer, or sold with the apparatus. When a cart is used, use caution when moving the cart / apparatus combination to avoid injury from tip-over.
- 13) Unplug this apparatus during lightning storms or when unused for long periods of time.
- 14) Refer all servicing to qualified service personnel. Servicing is required when the apparatus has been damaged in any way, such as power-supply cord or plug is damaged, liquid has been spilled or objects have fallen into the apparatus, the apparatus has been exposed to rain or moisture, does not operate normally, or has been dropped.
- 15) Operate only from the type of power source indicated on the marking label. If you are not sure of the type of power supplied to your home consult your television dealer or local power company.
- 16) Follow all warnings and instructions marked on the LCD TV.
- 17) Never push objects of any kind into this LCD TV through cabinet slots as they may touch dangerous voltage points or short out parts that could result in a fire or electric shock. Never spill liquid of any kind on the LCD TV.



Important Safety Instructions

18) If an outside antenna is connected to the television equipment, be sure the antenna system is grounded so as to provide some protection against voltage surges and built up static charges. In the U.S. Section 810-21 of the National Electrical Code provides information with respect to proper grounding of the mast and supporting structure, grounding of the lead-in wire to an antenna discharge unit, size of grounding conductors, location of antenna discharge unit, connection to grounding electrodes, and requirements for the grounding electrode.

19) An outside antenna system should not be located in the vicinity of overhead power lines or other electric light or power circuits, or where it can fall into such power lines or circuits. When installing an outside antenna system extreme care should be taken to keep from touching such power lines or circuits as contact with them might be fatal.

20) Unplug this LCD TV from the wall outlet, and refer servicing to qualified service personnel under the following conditions:

- When the power cord or plug is damaged or frayed.
- If liquid has been spilled into the LCD TV.
- If the LCD TV has been exposed to rain or water.
- If the LCD TV does not operate normally by following the operating instructions.

Adjust only those controls that are covered by the operating instructions as improper adjustment of other controls may result in damage and will often require extensive work by a qualified technician to restore the LCD TV to normal operation.

e. If the LCD TV has been dropped or the cabinet has been damaged.

f. When the LCD TV exhibits a distinct change in performance - this indicates a need for service.

21) When replacement parts are required, be sure the service technician uses replacement parts specified by the manufacturer that have the same characteristics as the original parts. Unauthorized substitutions may result in fire, electric shock, or other hazards.

22) **WARNING : TO REDUCE THE RISK OF FIRE OR ELECTRIC SHOCK, DO NOT EXPOSE THIS APPARATUS TO RAIN OR MOISTURE.**

DO NOT PLACE LIQUID CONTAINERS (FLOWER VASES, CUPS, COSMETICS, ETC.) ABOVE THE SET. (INCLUDING ON SHELVES ABOVE, ETC.)

23) **WARNING : KEEP UNNEEDED SMALL PARTS AND OTHER OBJECTS OUT OF THE REACH OF SMALL CHILDREN. THESE OBJECTS CAN BE ACCIDENTALLY SWALLOWED. ALSO, BE CAREFUL ABOUT PACKAGING MATERIALS AND PLASTIC SHEETS.**

24) **CAUTION : TO PREVENT ELECTRIC SHOCK DO NOT USE THIS PLUG WITH A RECEPTACLE OR OTHER OUTLET UNLESS THE BLADES CAN BE FULLY INSERTED TO PREVENT BLADE EXPOSURE.**

25) **CAUTION : USE WITH OTHER STAND MAY RESULT IN INSTABILITY POSSIBLY CAUSING INJURY.**

26) **CAUTION : DANGER OF EXPLOSION IF BATTERY IS INCORRECTLY REPLACED. REPLACE ONLY WITH THE SAME OR EQUIVALENT TYPE.**

EXAMPLE OF ANTENNA GROUNDING AS PER (NEC) NATIONAL ELECTRICAL CODE

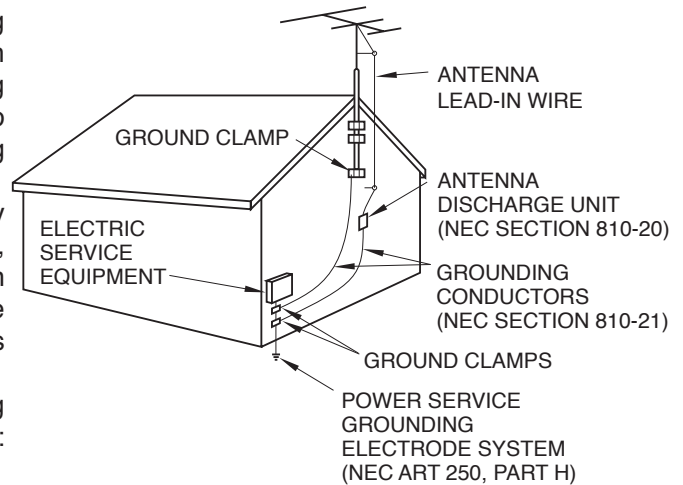

NOTE: • This equipment is designed to operate in North America and other countries where the broadcasting system and AC house current is exactly the same as in North America.

■ This product utilizes tin-lead solder, and has a fluorescent lamp containing a small amount of mercury. Disposal of these materials may be regulated in your community due to environmental considerations. For disposal or recycling information please contact your local authorities, or the Electronics Industries Alliance: www.eiae.org.

Dear Panasonic Customer

Welcome to the Panasonic family of customers.

We hope that you will have many years of enjoyment from your new LCD TV.

To obtain maximum benefit from your set, please read these instructions before making any adjustments, and retain them for future reference.

Retain your purchase receipt, and record the model number and serial number of your set in the space provided on the rear cover of these instructions.

For assistance, please call : 1-800-211-PANA (7262) or visit us at www.panasonic.com/contactinfo	(U.S.A.)
For assistance, please call : 787-750-4300 or visit us at www.panasonic.com	(Puerto Rico)
For assistance, please call : 1-800-561-5505 or visit us at www.panasonic.ca	(Canada)

Federal Communication Commission Information

This equipment has been tested and found to comply with the limits for a TV Broadcast Receiver, pursuant to Part 15 of the FCC Rules. These limits are designed to provide reasonable protection against harmful interference in a residential installation. This equipment generates, uses and can radiate radio frequency energy and, if not installed and used in accordance with the instructions, may cause harmful interference to radio communications. However, there is no guarantee that interference will not occur in a particular installation. If this equipment does cause or receive interference, which can be determined by turning equipment off and on, the user is encouraged to try to correct the interference by one or more of the following measures:

- Reorient or relocate the TV antenna.
- Increase the separation between TV and other equipment.
- Connect TV into separate outlet from other equipment.
- Consult the dealer or an experienced radio / TV technician for help.

FCC Caution: Any changes or modifications not expressly approved by the party responsible for compliance could void the user's authority to operate this equipment.



The ENERGY STAR® label, a symbol for energy efficiency, was created by the U.S. Environmental Protection Agency (EPA) and the U.S. Department of Energy (DOE) to help customers identify products that can save them money and protect the environment by saving energy. The ENERGY STAR® compliant products generally consume less energy than similar standard products.

er Warranty Card



• Product Registration Card and Customer Care Plan Card (For U.S.A.)

Installation

Receiver Location

Locate for comfortable viewing. Avoid placing where sunlight or other bright light (including reflections) will fall on the screen.

Use of some types of fluorescent lighting can reduce remote control transmitter range.

Adequate ventilation is essential to prevent internal component failure. Keep away from areas of excessive heat or moisture.

How to use the LCD stand

Adjust the stand to your desired angle.

• TC-20LA5

The stand angle can be adjusted between 5° forward and 15° back, and rotated 30° to the right/left.

• TC-20LE5

The stand angle is fixed 14° back.



Optional External Equipment

The Video/Audio connection between components can be made with shielded video and audio cables. For best performance, Antenna cables should utilize 75 ohm coaxial shielded wire. Cables are available from your dealer or electronic supply store.

Before you purchase any cables, be sure you know what type of output and input connectors your various components require. Also determine the length of cable you'll need.

For optimum quality picture

When the LCD is exposed to light from outdoors or lighting fixtures, high-contrast pictures may not be displayed clearly. Turn off florescent lamps near the LCD and place in a location not exposed to outdoor light.

How to hang the LCD Television on the wall

This LCD Television is for use only with the following optional accessory. Use with any other type of optional accessories may cause instability which could result in the possibility of injury.

- Wall-hanging bracket TY-WK22LR1W

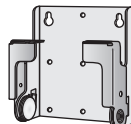
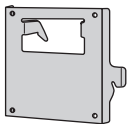

Always be sure to ask a qualified technician to carry out set-up.

Remote control battery installation

Requires two AA batteries.

1. Open the battery cover.

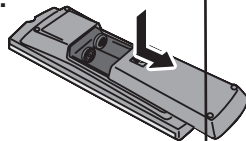

2. Install the batteries and replace the cover. Note the correct polarity (+ and -).

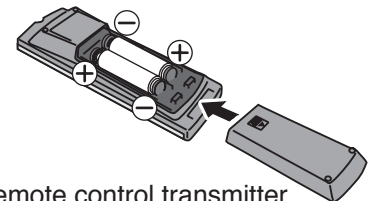

⚠ Precaution on battery use

Incorrect installation can cause battery leakage and corrosion that will damage the remote control transmitter. Disposal of batteries should be in an environmentally manner.

Observe the following precautions:

1. Always use new batteries when replacing the old set.
2. Do not attempt to charge, short-circuit, disassemble, heat or burn used batteries.
3. Battery replacement is necessary when remote control acts sporadically or fails to operate this unit.

Notes:

- Do not drop, apply shock to or step on the remote control.
- Do not spill water on the remote control.
- Do not place objects between the remote control and remote control receiver.
- Do not use remote controls for other equipment at the same time.
- If the TV does not operate even when using the remote control from a close range, it is time to replace the batteries. Refer to the label on back of the remote control for directions on replacing batteries.



Connecting Other Equipment

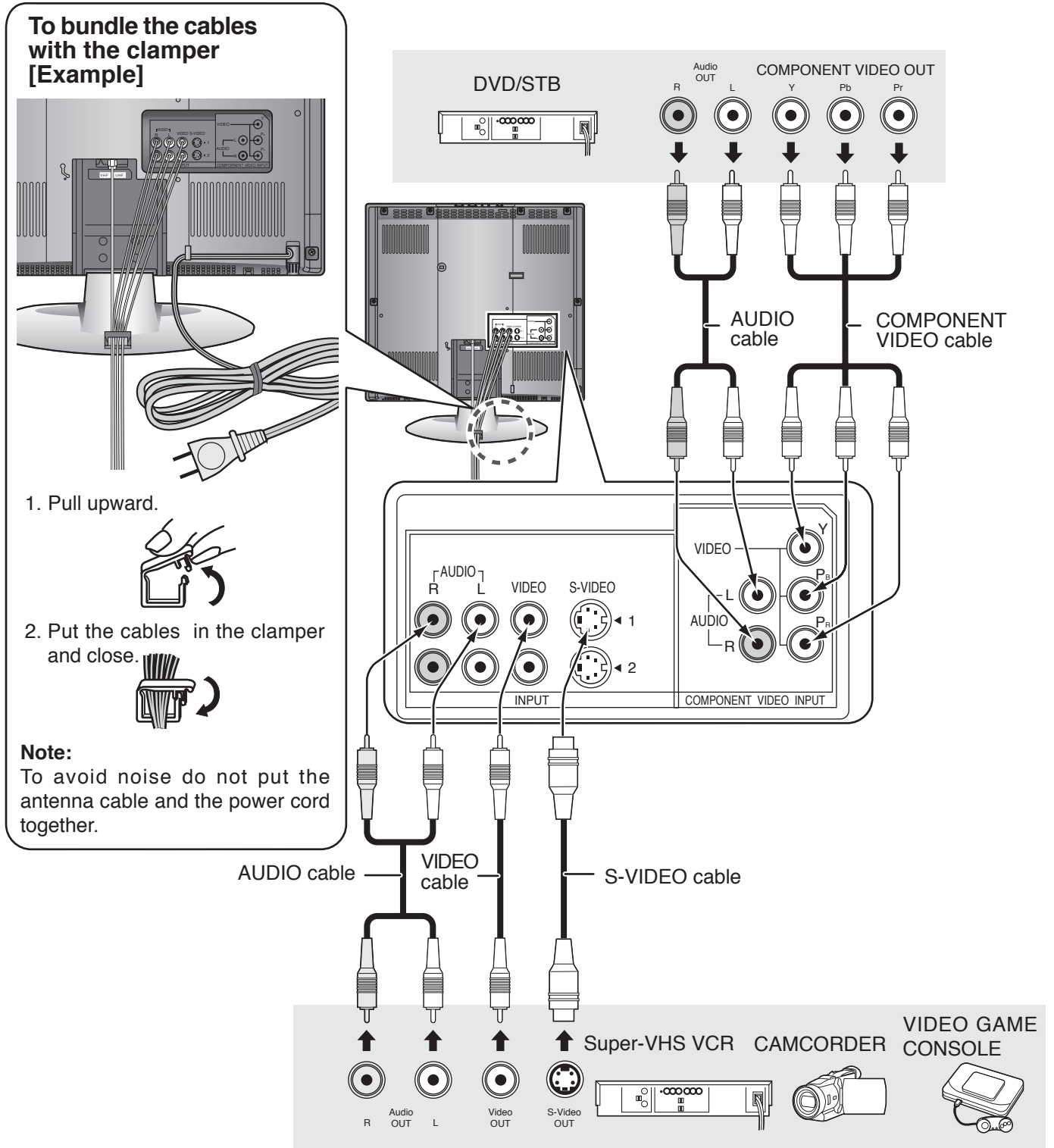

Notes:

- Only 480i and 480p are available through the component input terminals.
- When connecting video cables, priority is given to the S-Video cable when both the S-VIDEO input terminal and the VIDEO input terminal are connected.
- With a monaural VCR, connect the monaural audio cable to the AUDIO-L terminal.
- Please make inquiries of video game manufacturers concerning component cables to connect with video game console.

Connecting Headphones / Earphones

(Not supplied)

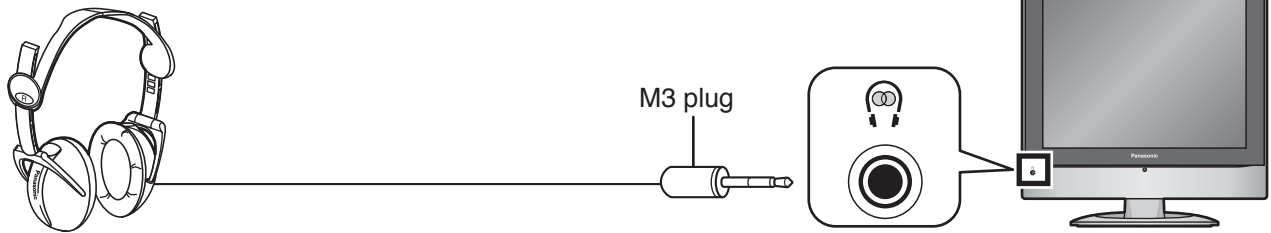

Power ON / OFF

Connecting the Plug to the Wall Outlet

Note:

The TV consumes some power as long as the power cord is inserted into the wall outlet.

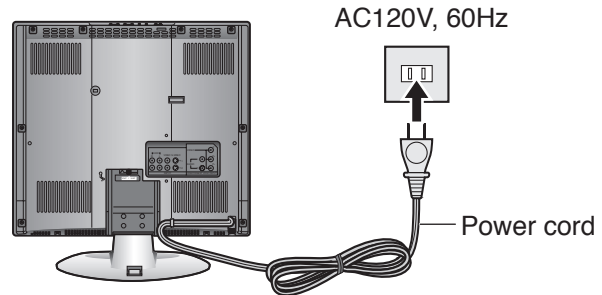

On the main unit



Press to turn the TV's main power on/off.

- Power indicator
Main power ON : Green
Main power OFF : No light

The screen below is displayed for a while when the TV is turned on.

e.g.

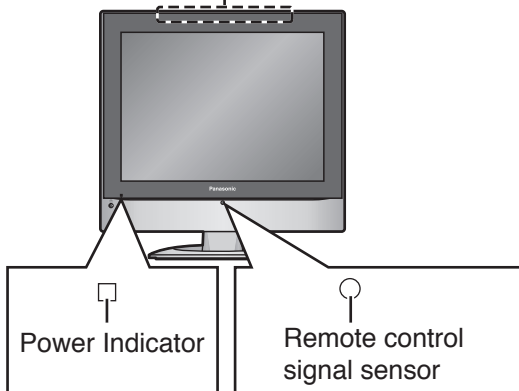
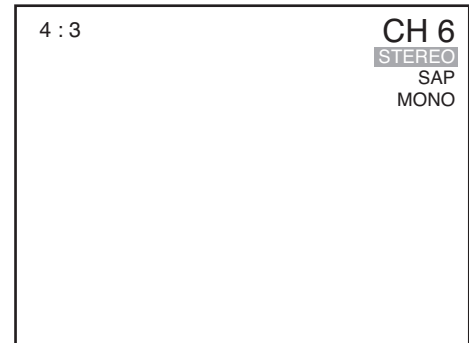

On the remote control



Press to turn the TV on/off.

- Power indicator
Power ON : Green
Power OFF (Standby) : Red
- This does not work when the main power is off (No light) (see above).

Note:

Select the menu language before operating the TV (see page 11, LANGUAGE).

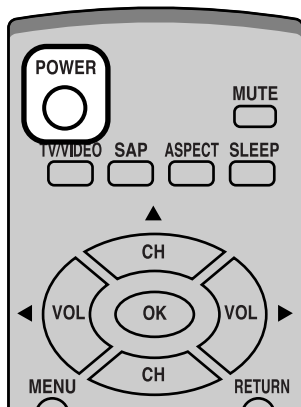

Menu Operations

1

Press to display MENU screen.

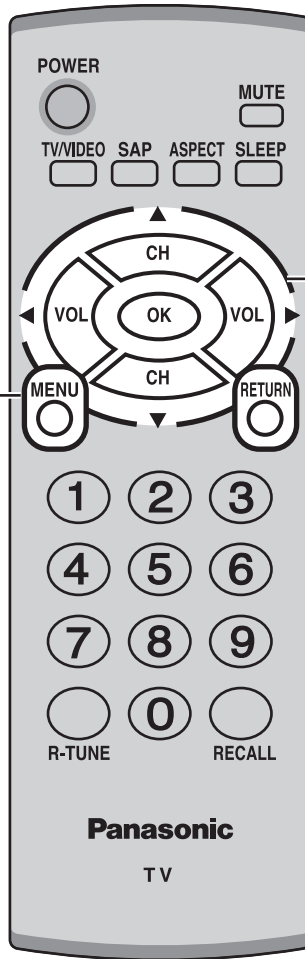
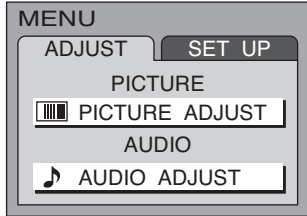

2

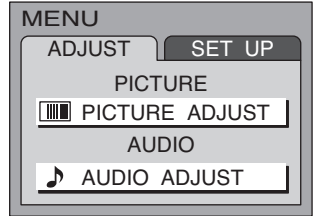

or

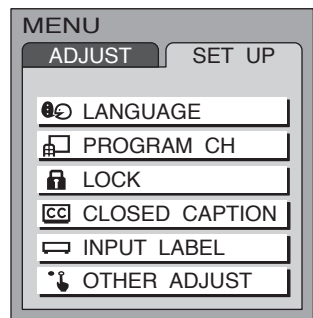
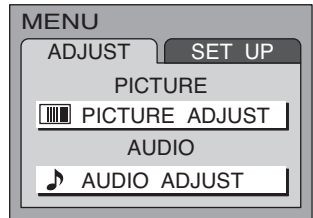
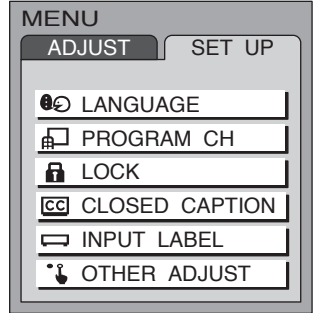

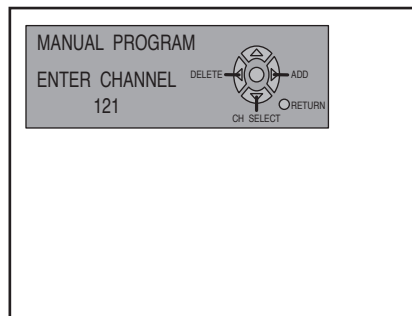

ON SCREEN HELP 'Instruction' box

An On Screen Help box is displayed when a menu is displayed on the TV. This Help box indicates which keys on the remote control are used to navigate the menu shown.

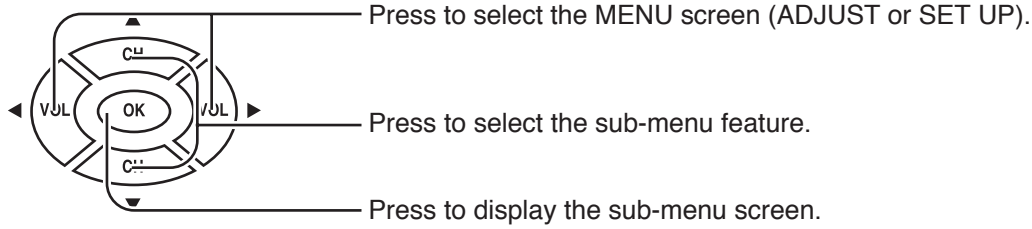



- To return to the previous screen : **RETURN** 
- To exit the MENU screen: **MENU**  This returns to the normal viewing.

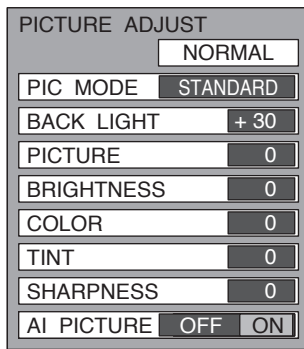

PICTURE ADJUST

NORMAL

PIC MODE STANDARD

BACK LIGHT +30

PICTURE 0

BRIGHTNESS 0

COLOR 0

TINT 0

SHARPNESS 0

AI PICTURE OFF ON

(See page 20)

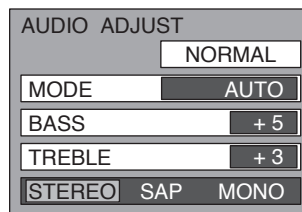

AUDIO ADJUST

NORMAL

MODE AUTO

BASS +5

TREBLE +3

STEREO SAP MONO

(See page 21)



LANGUAGE

LANGUAGE ENGLISH

Select the menu language.

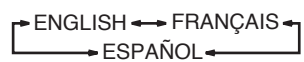

ENGLISH FRANÇAIS

ESPAÑOL

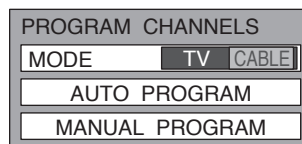

PROGRAM CHANNELS

MODE TV CABLE

AUTO PROGRAM

MANUAL PROGRAM

(See page 13)

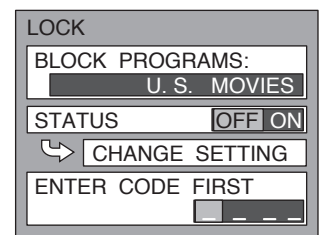

LOCK

BLOCK PROGRAMS:

U. S. MOVIES

STATUS OFF ON

CHANGE SETTING

ENTER CODE FIRST

(See page 14 - 17)

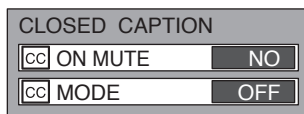

CLOSED CAPTION

CC ON MUTE NO

CC MODE OFF

(See page 18)

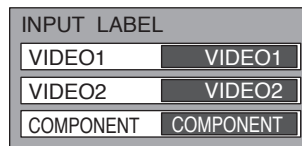

INPUT LABEL

VIDEO1 VIDEO1

VIDEO2 VIDEO2

COMPONENT COMPONENT

(See page 19)

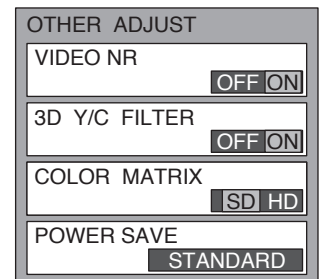

OTHER ADJUST

VIDEO NR OFF ON

3D Y/C FILTER OFF ON

COLOR MATRIX SD HD

POWER SAVE STANDARD

(See page 19)

Basic Controls

Main POWER switch
Press to turn the TV's main power on/off. (see page 9)

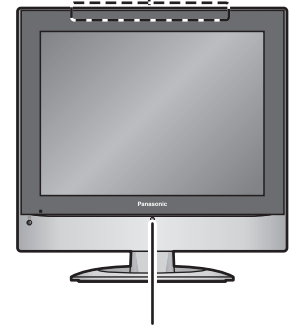
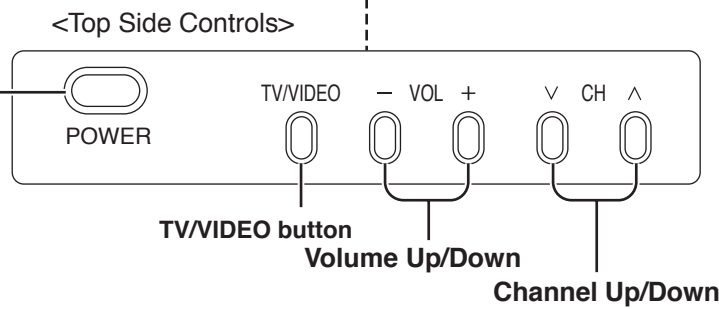

Remote control sensor
Within about 23 feet (7 meters) in front of the TV set.

POWER button
Press to turn the TV on or off. (see page 9)
Note:
This does not work when the main power is off (No light).

MUTE button
Press to mute the sound.
Press again to cancel mute.
Mute is canceled when the power is turned off or volume level is changed.

TV/VIDEO button
Press to change the input mode.



SAP button
Press to select the audio mode. You can also change the mode in the MENU screen (see page 21).

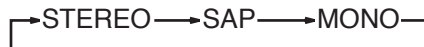

MENU button
(see page 10)

RETURN button
Press to return to the previous screen.

Numbered buttons

R-TUNE button
Press to switch to previously viewed channel or video mode.
Not effective under the following conditions:

1. Right after the TV is turned on.
2. After switching TV / CATV (MODE in PROGRAM CHANNELS).
3. Right after the ACP (Automatic channel programming) execution.
4. When the same channel as the present channel is selected.

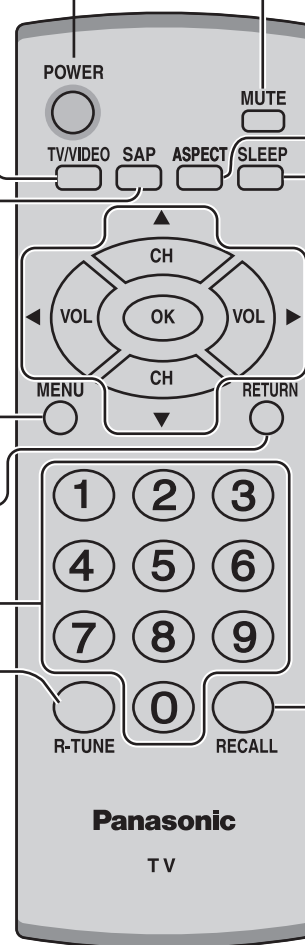

ASPECT button
(see page 22)

SLEEP button
Set the sleep time to turn the TV into standby mode.

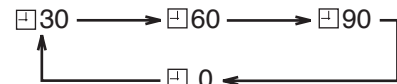

- When 3 minutes left, " 3 " will flash. ("2" for 2 minutes and "1" for 1 minute).
- The SLEEP timer is cancelled when the power is turned off.

Channel up
Moves cursor upward during menu mode.

Reduces volume
Moves cursor to the left during menu mode.

Increases volume
Moves cursor to the right during menu mode.

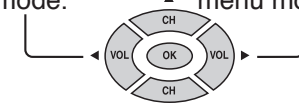

Channel down
Moves cursor downward during menu mode.

RECALL button
Press to display channel number, sleep timer and other options.

Tuning Channels

- 1 Press the TV/VIDEO button to display the TV channel.
- 2 Press the MENU button to display the MENU screen and select SET UP.

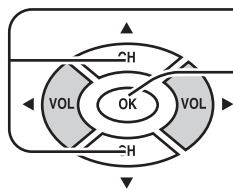

Press to select PROGRAM CH.

Press to display the PROGRAM CHANNELS screen.

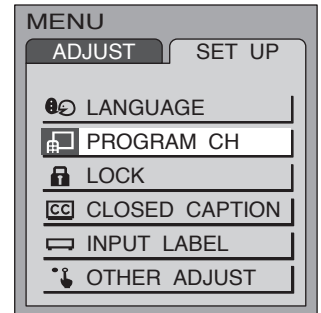

[MODE selection]

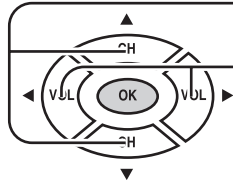
- 3 Press to select MODE.
- 
- Press to select TV or CABLE.

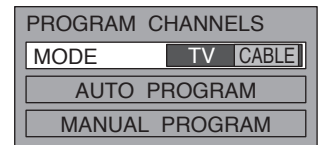

Automatic channel programming

Automatically scans and stores all the TV channels.

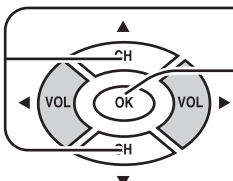
- 4 Press to select AUTO PROGRAM.
- 
- Press to display the AUTO PROGRAM screen.

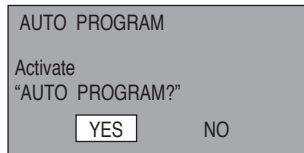

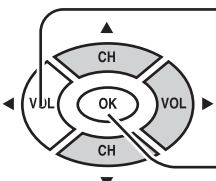
- 5 Press to select YES.
- 
- Press to start AUTO PROGRAM.

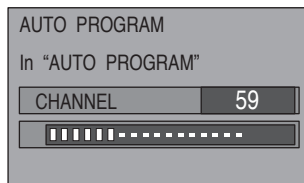

Channels will automatically advance until all channels have been scanned. Channel numbers with video signal received will be stored in the Channel Memory.

Notes:

- When any button is pressed during AUTO PROGRAM, the TV will return to the normal viewing. (Channels searched up to that point are added.)
- After AUTO PROGRAM finishes, the lowest channel number added will be displayed.
- When there is no receivable channel, channel 69 (for TV) or channel 125 (for cable TV) is displayed.

Manual channel programming

Add or delete a channel manually.

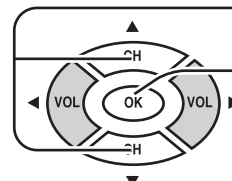
- 4 Press to select MANUAL PROGRAM.
- 
- Press to display the MANUAL PROGRAM screen.

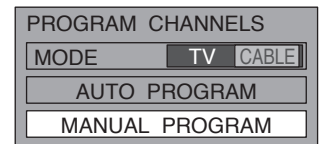

- 5 Press to select the channel.
- You can also use the numbered buttons.

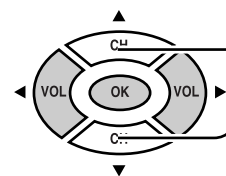

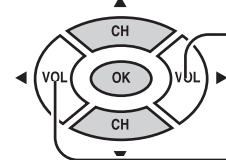
- 6 Press to add the channel to the Channel Memory (the channel number turns blue).
- 
- Press to delete the channel from the Channel Memory (the channel number turns yellow).

- Repeat steps 5 and 6 for other channels.

LOCK

V-Chip technology allows parents to use the TV rating codes to block programs that they feel are inappropriate for their children to watch.

- 1 Press the MENU button to display the MENU screen and select SET UP.

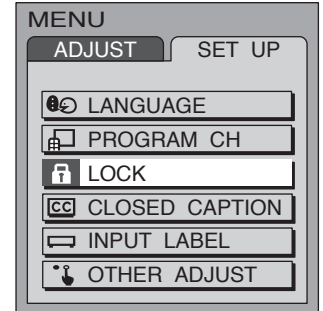
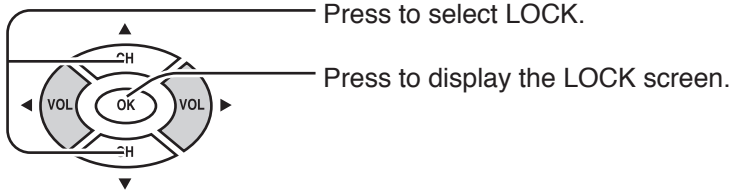

- 2
 - Input 4-digit code.
 - To clear the numbers while entering the code, press Up or Down .
 - You will need the code to enter the LOCK menu.
 - After entering your password for the first time, ENTER CODE FIRST will change to CHANGE CODE.

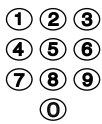

Note:

Use a code that is easy to remember and record it in a safe place.

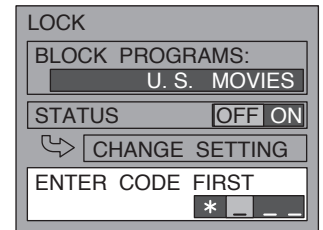

- 3
 - Press to select BLOCK PROGRAMS.
 - Press to select U.S. MOVIES, U.S. TV PROGRAMS, CANADIAN ENGLISH or CANADIAN FRENCH.

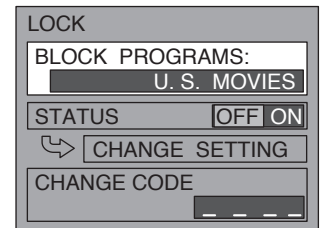
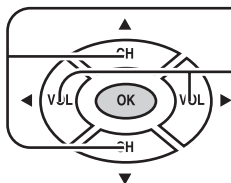

- 4
 - Press to select STATUS.
 - Press to select OFF or ON.
 - OFF : Can view all programs.
 - ON : Cannot view programs locked in CHANGE SETTING.

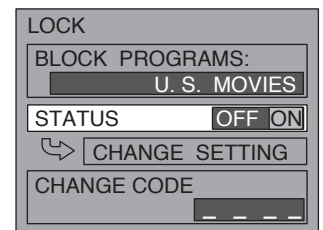
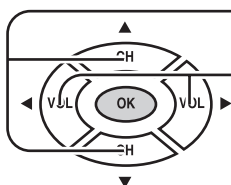

- 5
 - Press to select CHANGE SETTING.
 - Press to enter the next menu.

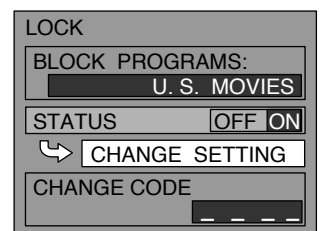
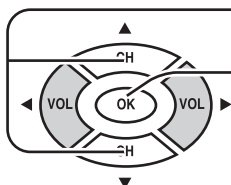

U.S. MOVIES

This TV features the “V-Chip technology” which allows you to use Motion Picture Ratings when viewing movies or video tapes. This innovation allows parents to block various types of movies and video tapes at their discretion.

6

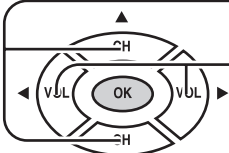

Press to select VIEW NR PROGRAMS?.

Press to select NO or YES.
 NO : Cannot view programs with NR signals.
 YES : Can view programs with NR signals.

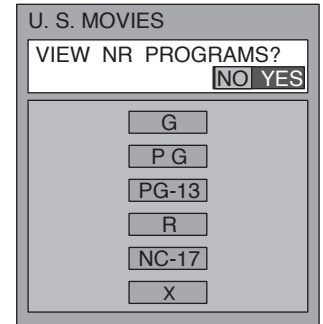

7

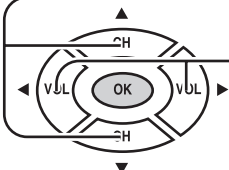

Press to select the rating.

Press to lock or unlock the rating.
 Lock : Red
 Unlock : Green

Notes:

- When a rating is locked, all ratings below this rating are locked.
- When a rating is unlocked, all ratings above this rating are unlocked.

NR	CONTAINS NO RATING (NOT RATED) AND NA (NOT APPLICABLE) PROGRAMS. Movie has not been rated or rating does not apply.
G	GENERAL AUDIENCES. All ages admitted.
PG	PARENTAL GUIDANCE SUGGESTED. Some material may not be suitable for children.
PG-13	PARENTS STRONGLY CAUTIONED. Some material may be inappropriate for children under 13.
R	RESTRICTED. Under 17 requires accompanying parent or adult guardian.
NC-17	NO ONE 17 AND UNDER ADMITTED.
X	ADULTS ONLY.

U.S. TV PROGRAMS

This TV features the “V-Chip technology” which allows you to use U.S. TV PROGRAMS Guide ratings to block various types of TV programs.

6

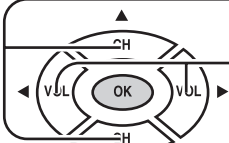

Press to select VIEW NR PROGRAMS?.

Press to select NO or YES.
 NO : Cannot view programs with NR signals.
 YES : Can view programs with NR signal.

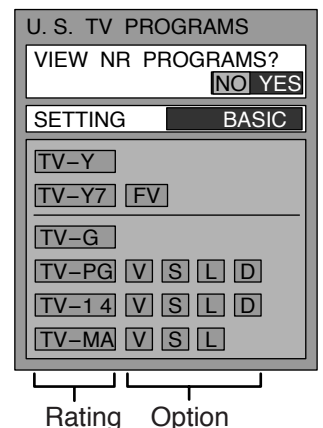

7

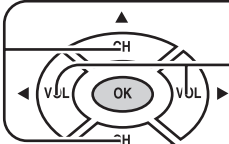

Press to select SETTING.

Press to select BASIC or DETAILED.
 BASIC : You can select the ratings.
 DETAILED : You can select the ratings and options.

8

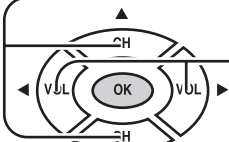

Press to select the rating.

Press to lock or unlock the rating.
 Lock : Red
 Unlock : Green

Notes:

- When a rating is locked, all ratings (including options) below this rating are locked.
- When a rating is unlocked, all ratings (including options) above this rating are unlocked.
- When an option (V, S, L or D) is locked, all the same options (V, S, L or D) below this rating are locked.
- When an option (V, S, L or D) is unlocked, all the ratings and the same options (V, S, L or D) above this rating are unlocked.

LOCK

NR	Not Rated. See Customer Caution below.
TV-Y	All children. The themes and elements in this program are specifically designed for a very young audience, including children from ages 2-6.
TV-Y7	Directed to older children. Themes and elements in this program may include mild physical or comedic violence, or may frighten children under the age of 7.
TV-G	General audience. It contains little or no violence, no strong language, and little or no sexual dialogue or situations.
TV-PG	Parental guidance suggested. The program may contain infrequent coarse language, limited violence, some suggestive sexual dialogue and situations.
TV-14	Parents strongly cautioned. This program may contain sophisticated themes, sexual content, strong language and more intense violence.
TV-MA	Mature audiences only. This program may contain mature themes, profane language, graphic violence, and explicit sexual content.
FV	FANTASY/CARTOON VIOLENCE
V	VIOLENCE
S	SEX
L	OFFENSIVE LANGUAGE
D	DIALOGUE WITH SEXUAL CONTENT

Customer Caution

The V-Chip system that is used in this set is capable of blocking “NR” programs (non rated, not applicable as and none) per FCC Rules Section 15.120(e)(2). If the option of blocking “NR” programs is chosen “unexpected and possibly confusing results may occur, and you may not receive emergency bulletins or any of the following types of programming:”

- Emergency Bulletins (Such as EAS messages, weather warnings and others)
- Locally originated programming • News • Political • Public Service Announcements • Religious • Sports
- Weather

CANADIAN ENGLISH / CANADIAN FRENCH

The V-CHIP used in this TV allows you to block various types of movies and television programs based on the two rating systems used in Canada. It also lets you block or unblock Canadian French programs according to various ratings categories.

6

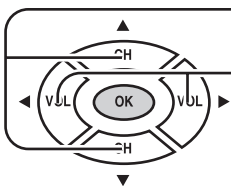

Press to select VIEW E PROGRAMS?.*

Press to select NO or YES.

NO : Cannot view programs with E signals.

YES : Can view programs with E signals.

*E means Exempt.

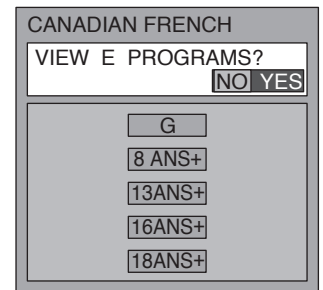
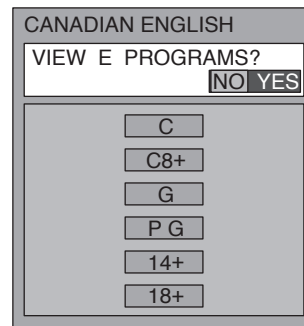

7

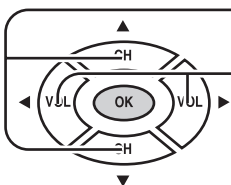

Press to select the rating.

Press to lock or unlock the rating.

Lock : Red

Unlock : Green

Notes:

- When a rating is locked, all ratings below this rating are locked.
- When a rating is unlocked, all ratings above this rating are unlocked.

CANADIAN ENGLISH RATINGS CHART

E	Exempt - Exempt programming includes: news, sports, documentaries and other information programming, talk shows, music videos, and variety programming.
C	Programming intended for children under age 8. No offensive language, nudity or sexual content.
C8+	Programming generally considered acceptable for children 8 years and over. No profanity, nudity or sexual content.
G	General programming, suitable for all audiences.
P G	Parental Guidance suggested. Some material may not be suitable for children.
14+	Programming contains themes or content which may not be suitable for viewers under the age of 14. Parents are strongly cautioned to exercise discretion in permitting viewing by pre-teens and early teens.
18+	18+ years old. Programming restricted to adults. Contains constant violence or scenes of extreme violence.

CANADIAN FRENCH RATINGS CHART

E	Exempt - Exempt programming.
G	General - Programming intended for audience of all ages. Contains no violence, or the violence content is minimal or is depicted appropriately.
8 ANS+	8+ General - Not recommended for young children. Programming intended for a broad audience but contains light or occasional violence. Adult supervision recommended.
13ANS+	Programming may not be suitable for children under the age of 13 - Contains either a few violent scenes or one or more sufficiently violent scenes to affect them. Adult supervision strongly suggested.
16ANS+	Programming may not be suitable for children under the age of 16 - Contains frequent scenes of violence or intense violence.
18ANS+	18+ ans Programming restricted to adults. Contains constant violence or scenes of extreme violence.

CLOSED CAPTION

This unit has a built in decoder that provides a visual depiction of the audio portion of a television program in the form of written words across the screen (white or colored letters on a black background). It allows you to read the dialogue of a television program or other information.

Note:

This feature is available only with the 480i input signal and with programs that include closed captions.

1 Press the MENU button to display the MENU screen and select SET UP.

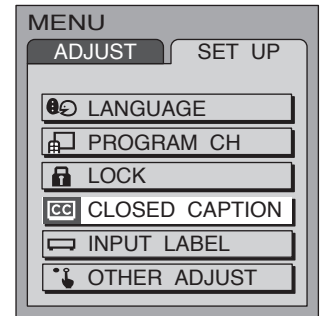
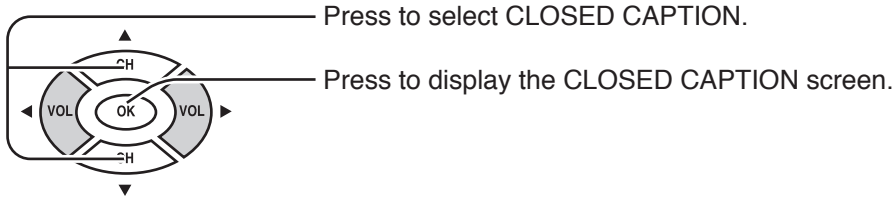

CC ON MUTE

Displays the On-Screen Closed Caption when the MUTE button is pressed. To delete the closed caption, press the MUTE button again.

2 - 1

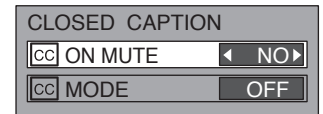
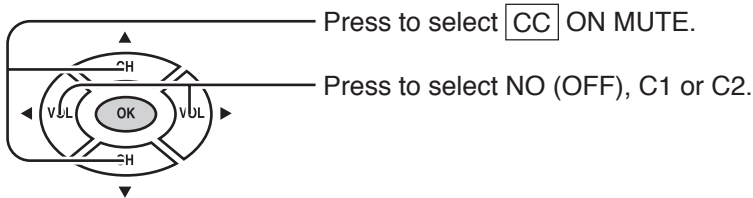

Notes:

- To activate this feature, set **CC** MODE to OFF.
- The program must have Closed Caption.

CC MODE

Displays the On-Screen Closed Caption.

2 - 2

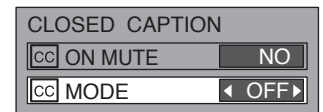
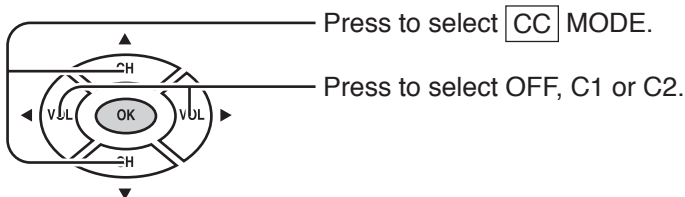

- **OFF (NO)** Recommended mode when Closed Caption is not being used.
- **C1** For video related information that can be displayed (up to 4 lines of script strategically placed on the television screen so that it does not obstruct relevant parts of the picture).
- **C2** Another mode used for video related information.

INPUT LABEL

You can change the video input labels displayed on the screen to match the connected device (VCR, DVD player, etc.).

- 1** Press the MENU button to display the MENU screen and select SET UP.

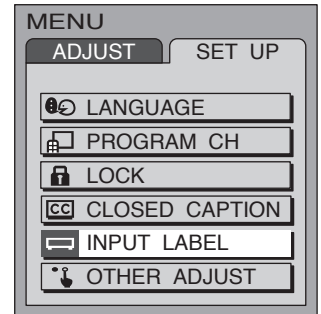
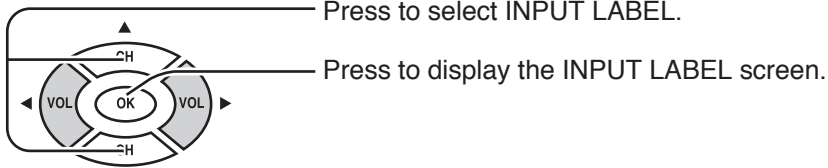

- 2**
- Press to select the video input (VIDEO1, VIDEO2 or COMPONENT).
- Press to select the INPUT LABEL (VIDEO1/VIDEO2/COMPONENT, VCR, LD, GAME, DVD, DTV, SKIP* or [BLANK])

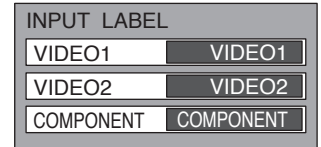
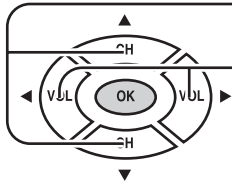

* Select to skip unused video input when pressing TV/VIDEO button.

OTHER ADJUST

- 1** Press the MENU button to display the MENU screen and select SET UP.

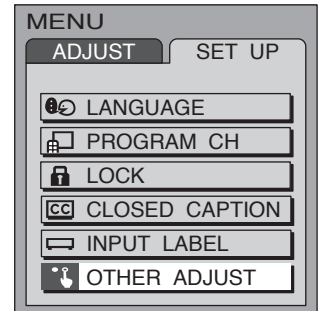
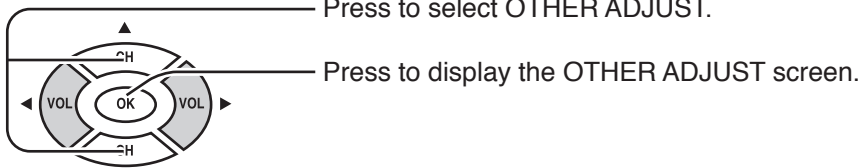

- 2**
- Press to select the item.
- Press to select the setting.

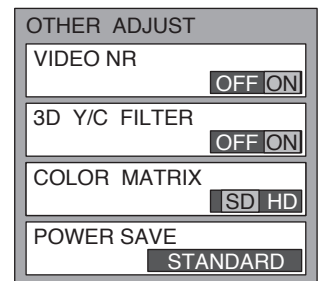
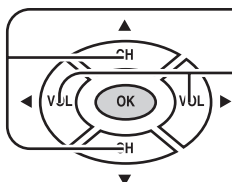

VIDEO NR

Reduce video noise in the picture.

OFF ↔ ON

3D Y/C FILTER

Minimizes noise and cross color in the picture.

Not available for COMPONENT VIDEO INPUT and S-VIDEO INPUT.

OFF ↔ ON

COLOR MATRIX

Displays input signals (480p signals) in natural color. Automatically adjusts color parameters for HD (high definition) and SD (standard definition).

SD ↔ HD

Note:

COLOR MATRIX is effective only when 480p signal is input in COMPONENT input mode.

In any other case the indication of COLOR MATRIX becomes blue, and changing between SD and HD is not possible.

POWER SAVE

Reduces screen brightness to lower power consumption. Eye-friendly for viewing in a dark room.

STANDARD ↔ SAVING

PICTURE ADJUST

1

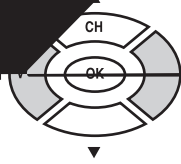

Press to select PICTURE ADJUST.

Press to display the PICTURE ADJUST screen.

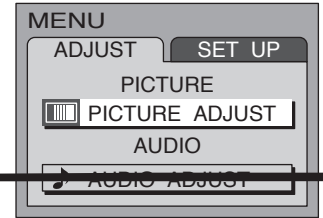

2

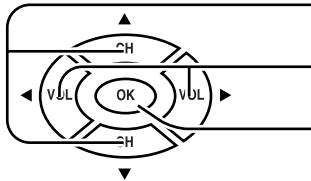

Press to select the sub-menu.

Adjust the setting while watching the picture behind the menu.

Press to activate the setting if necessary.

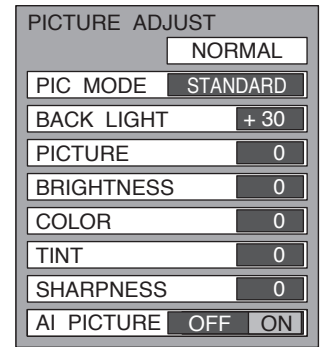

NORMAL/NORMALIZE

Select "NORMALIZE" and press "OK" button to return each PIC MODE to the factory default setting.

Notes:

- "NORMAL" means the PIC MODE is at the factory default setting. "NORMAL" changes to "NORMALIZE" when you change the setting of BACK LIGHT, PICTURE, BRIGHTNESS, COLOR, TINT, SHARPNESS or AI PICTURE.
- You can normalize each PIC MODE separately.

PIC MODE

The picture mode is stored for TV, VIDEO1, VIDEO2 and COMPONENT individually.

BACK LIGHT, PICTURE, BRIGHTNESS, COLOR, TINT, SHARPNESS, AI PICTURE

You can change the sub-menu settings (BACK LIGHT, PICTURE, BRIGHTNESS, COLOR, TINT, SHARPNESS and AI PICTURE) for each PIC MODE (STANDARD, CINEMA, and VIVID) according to your personal preference.

AUDIO ADJUST

1 Press the MENU button to display the MENU screen and select ADJUST.

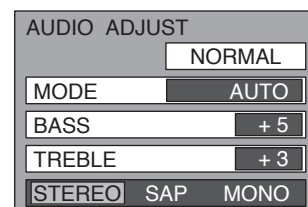
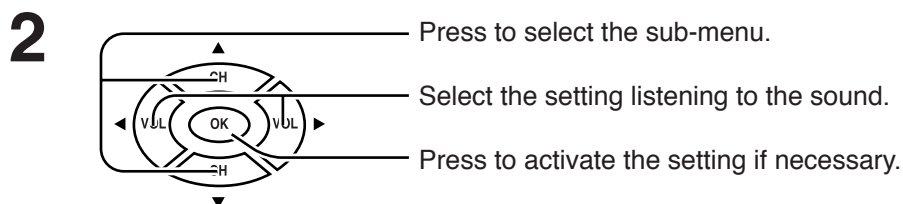
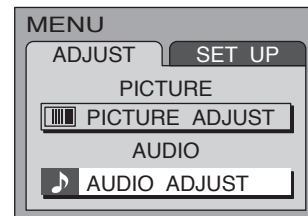
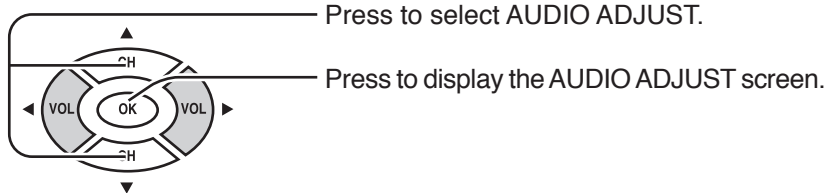

NORMAL/NORMALIZE

Select "NORMALIZE" and press "OK" button to return each MODE to the factory default setting.

Notes:

- "NORMAL" means the MODE is at the factory default setting. "NORMAL" changes to "NORMALIZE" when you change the setting of BASS or TREBLE.
- You can normalize each MODE separately.

MODE

MODE	Function
AUTO	Automatically adjusts for a wide Dynamic Range.
STANDARD	Emits the original sound.
DYNAMIC	Gives contrast to sound.
MUSIC	For programs consisting mainly of music. Enhances high sounds (around 4 kHz).

BASS, TREBLE

You can change the level of each sub-menu (BASS and TREBLE) for each MODE (AUTO, STANDARD, DYNAMIC and MUSIC) according to your personal preference.

Sub-menu	Function
BASS	Adjusts low frequencies.
TREBLE	Adjusts high frequencies.

STEREO/SAP/MONO

Notes:

- Red display : With signal
- White display : No signal
- White display (All modes) : MONO
- To change the mode using SAP button (see page 12).

MODE	Function
STEREO	Two channel audio reception.
SAP	Second Audio Programming (typically used for bilingual audio).
MONO	Select when stereo signal is weak.

ASPECT Controls

(For Video input only)

This feature allows you to enjoy viewing the picture at its maximum size, including wide screen cinema format picture.

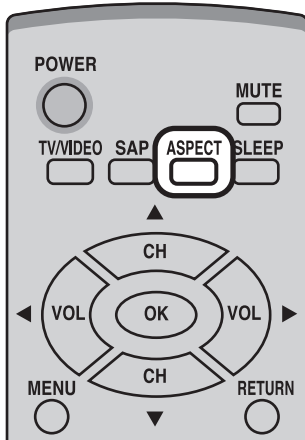

ASPECT

Each time you press the button:

4 : 3 ↔ 16 : 9

Notes:

- The aspect setting is stored separately for VIDEO1, VIDEO2 and COMPONENT.
- In TV mode, the aspect is fixed at 4:3.

Mode	Picture	Explanation
4 : 3		4:3 mode will display a 4:3 picture at its standard 4:3 size without any stretching.
16 : 9 (not available in TV mode)		16:9 mode will display 16:9 aspect ratio picture. Bars can be seen at the top and bottom of the image (not available in TV mode).

Manual de instrucciones [Resumen]

Estimado cliente de Panasonic

Bienvenido a la familia de clientes de Panasonic.

Esperamos sinceramente que disfrute durante muchos años de su nuevo *Esperamos sinceramente que disfrute durante muchos años de su nuevo* televisor LCD.

Para obtener el máximo beneficio de su aparato, lea estas instrucciones antes de hacer cualquier ajuste, y guárdelas para poder utilizarlas como referencia en el futuro.

Guarde también el recibo de su compra, y anote el número del modelo y el número de serie de su aparato en el espacio provisto en la cubierta posterior de estas instrucciones.

Instalación

Ajuste el soporte con el ángulo deseado

• TC-20LA5

El ángulo del soporte se puede ajustar entre 5° hacia delante y 15° hacia atrás, y se puede girar 30° hacia la derecha/izquierda.

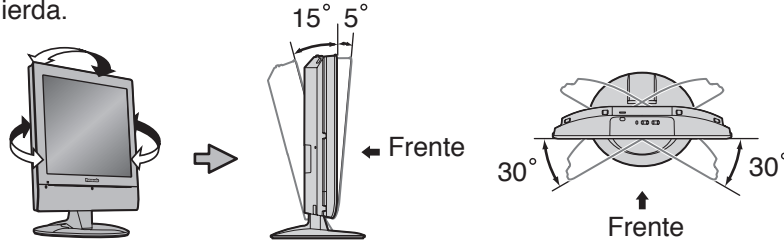

• TC-20LE5

El ángulo del soporte está fijado en 14° hacia atrás.

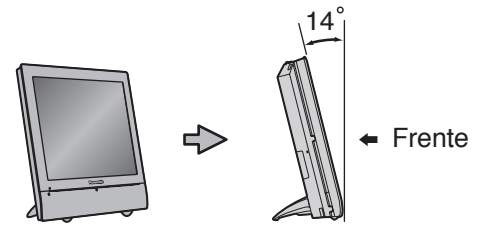

Modo de colgar el televisor LCD en la pared

Este televisor LCD solamente puede ser utilizado con el accesorio opcional siguiente. Si se utiliza con cualquier otro tipo de accesorio opcional podrá producir inestabilidad con la consiguiente posibilidad de ocasionar heridas.

- Soporte para colgar en pared TY-WK22LR1W

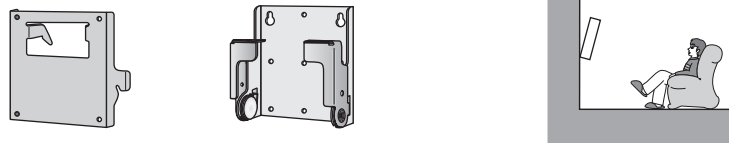

Asegúrese siempre de pedir a un técnico cualificado que le haga la instalación.

Instalación de las pilas del mando a distancia

Se necesitan dos pilas AA.

1. Abra la cubierta de las pilas.

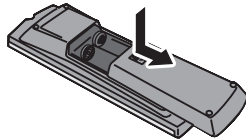

2. Instale las pilas y vuelva a poner la tapa. Tenga en cuenta las polaridades (+ y -) al instalar las pilas.

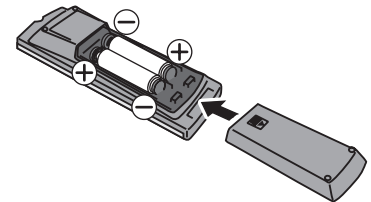

⚠ Precauciones relacionadas con la utilización de las pilas

La instalación incorrecta de las pilas puede causar fugas en las mismas que podrían estropear el transmisor de mando a distancia.

Las pilas deben desecharse por medios ecológicos.

Tome las precauciones siguientes:

1. Utilice siempre pilas nuevas cuando reemplace las viejas.
2. No intente cargar, cortocircuitar, desarmar, calentar o quemar las pilas usadas.
3. Las pilas deberán cambiarse cuando el mando a distancia funcione esporádicamente o no pueda controlar esta unidad.

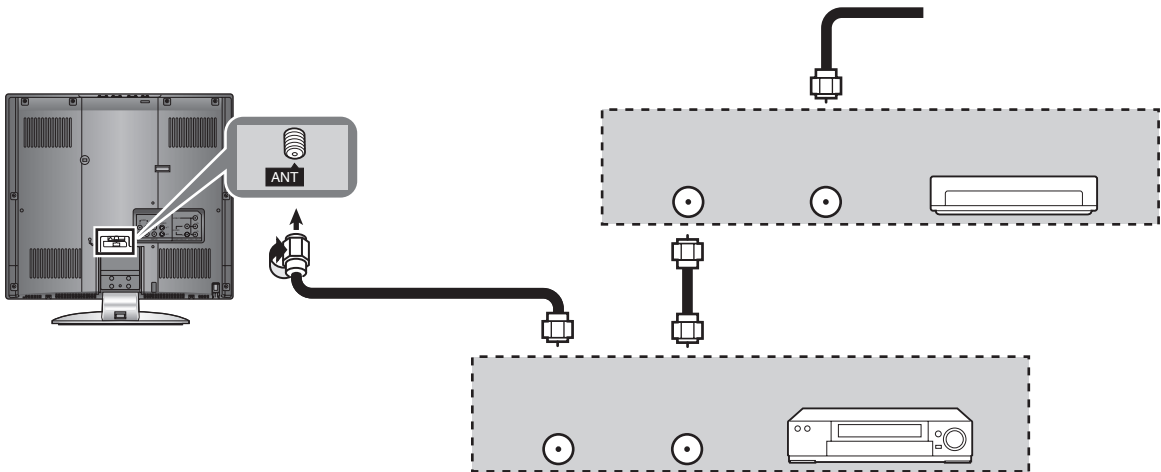
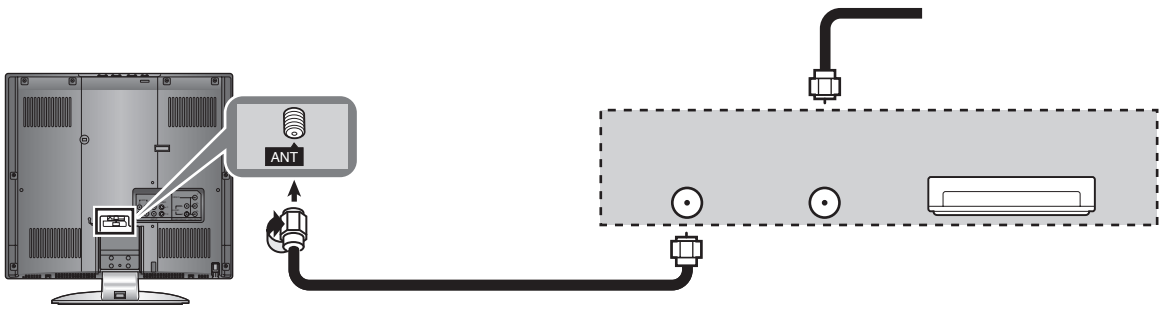
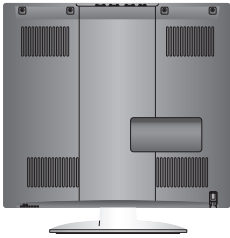

Operaciones con menús

1

Púselo para visualizar la pantalla MENU.

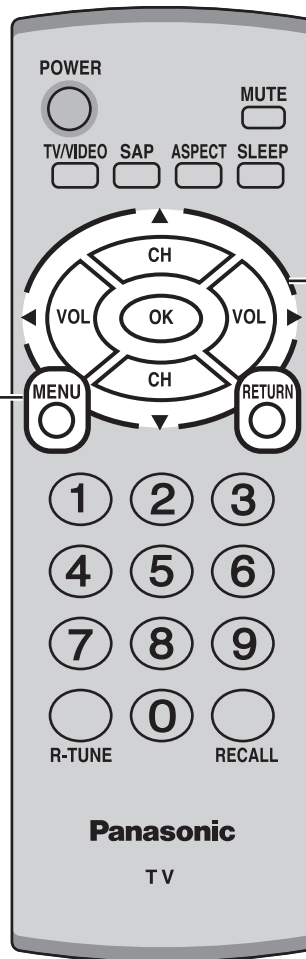
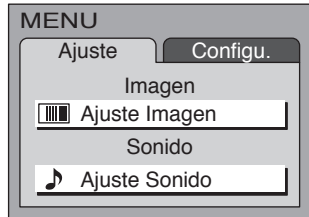

2

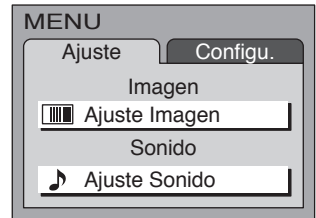

o

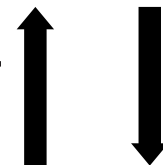
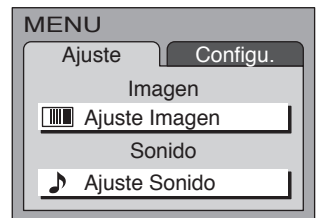

Cuadro de instrucciones de ayuda en pantalla

Cuando se visualiza un menú en el televisor aparece un cuadro de ayuda en la pantalla. Este cuadro de ayuda indica qué teclas del mando a distancia se utilizan para navegar por el menú mostrado.

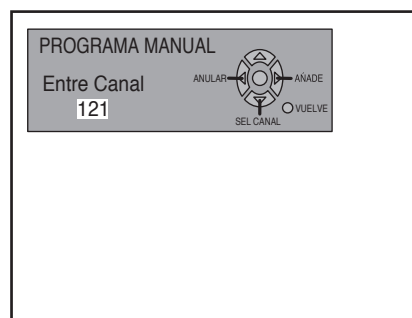

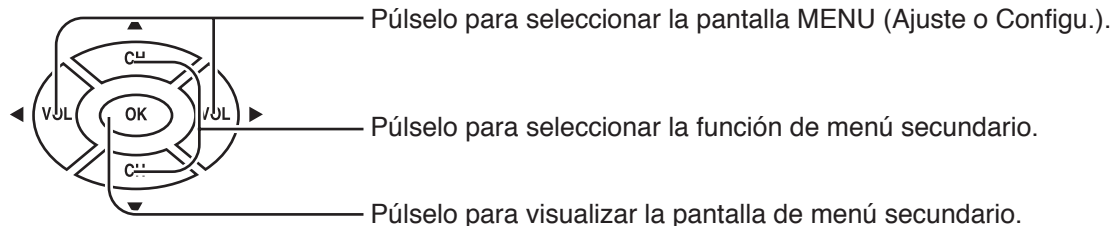

• Para volver a la pantalla anterior :

RETURN



• Para salir de la pantalla MENU :

MENU



Con esto se retorna a la visión normal.

Ajuste Imagen

Normal

Imagen Normal

Luz Posterior +30

CONTRASTE 0

BRILLO 0

COLOR 0

TINTE 0

NITIDEZ 0

Imagen IA No Si

Ajuste Sonido

Normal

Sonido Auto

BAJOS +5

ALTOS +3

ESTEREO SPA MONO

Idioma

Idioma < ESPAÑOL >

Seleccione el idioma del menú.

ENGLISH ↔ FRANÇAIS

↳ ESPAÑOL ◀

Prog. Canales

MODO TV CABLE

PROGRAMA AUTO

PROGRAMA MANUAL

Bloqueo

Programas:

Películas de EEUU

Activado No Si

Modificar

INGRESAR CLAVE

Subtítulos

cc EN MUDO No

MODO No

Ponga Títulos

Video1 Video1

Video2 Video2

Componente Componente

Otro Ajuste

REDUC DE RUIDO No Si

3D Y/C Filtro No Si

Matriz Color DS HD

ECON ENERGÍA ESTÁNDAR



Sintonización de canales

- 1 Pulse el botón TV/VIDEO para visualizar el canal de TV.
- 2 Pulse el botón MENU para visualizar la pantalla MENU y seleccione Configu.

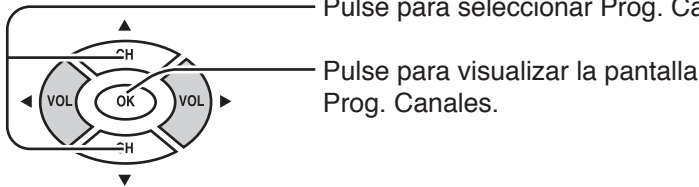

[Selección del mode]

- 3 Pulse para seleccionar MODO.

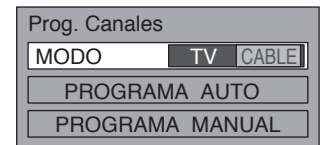
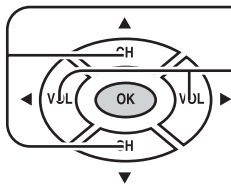

Programación automática de canales

Explora y guarda automáticamente todos los canales de TV.

- 4 Pulse para seleccionar PROGRAMA AUTO. Púlselo para visualizar la pantalla PROGRAMA AUTO.

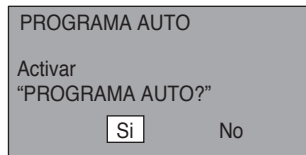
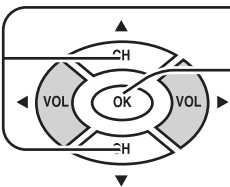

- 5 Púlselo para seleccionar Si.

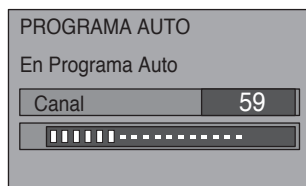
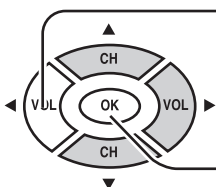

Los canales avanzarán automáticamente hasta que todos ellos hayan sido explorados. Los números de los canales con señal de vídeo recibida se guardarán en la memoria de canales.

Notas:

- Cuando se pulse cualquier botón durante PROGRAMA AUTO, el televisor volverá a mostrar la imagen normal. (Los canales encontrados hasta ese punto se añaden.)
- Después de terminar PROGRAMA AUTO se visualizará el número del canal más bajo añadido.
- Cuando no hay canal que puedan recibirse, se visualizará el canal 69 (para TV) o el canal 125 (para TV por cable).

Programación automática de canales

Añada o borre un canal manualmente.

- 4 Pulse para seleccionar PROGRAMA MANUAL. Púlselo para visualizar la pantalla PROGRAMA MANUAL.

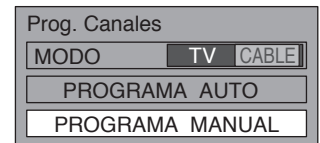
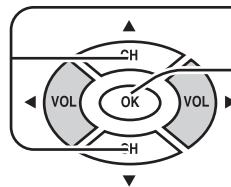

- 5 Pulse para seleccionar canal. • También puede utilizar los botones numerados.

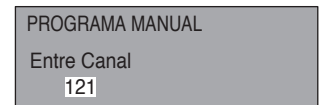
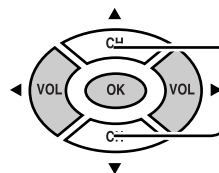



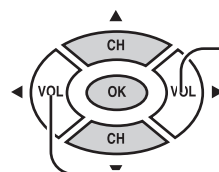













- 6 Púlselo para añadir el canal a la memoria de canales (el número del canal se pone de color azul). Púlselo para borrar el canal de la memoria de canales (el número del canal se pone amarillo).



- Repita los pasos 5 y 6 para otros canales.

Troubleshooting

If there is a problem with your TV please refer to the table below to determine the symptoms, then carry out the suggested check. If this does not solve the problem, please contact your local Panasonic dealer, quoting the model number and serial number (both found on the rear of the TV).

Symptoms		Checks
Picture	Sound	
 Snowy Picture	 Noisy Sound	Antenna location, direction or connection
 Multiple Images	 Normal Sound	Antenna location, direction or connection
 Interference	 Noisy Sound	Electrical appliances Cars/Motorcycles Fluorescent lights
 Normal Picture	 No Sound	Volume level Sound mute switched on. STEREO/SAP/MONO
 No Picture	 No Sound	TV set to AV mode. Not plugged into AC outlet. Not switched on. Picture/Sound controls set at minimum levels. Check if in Standby mode.
 No Color	 Normal Sound	Color controls set at minimum levels. Weak signal.
 Poor or Distorted Picture	 Weak or No Sound	Retune Channel(s).
 Normal Picture	 Weak, Wrong or No Sound	Sound reception may have deteriorated. Set STEREO/SAP/MONO setting (AUDIO ADJUST menu) to SAP or MONO until reception improved.
Cannot operate with the remote control.		The battery/ies is/are exhausted. The batteries' polarity is wrong. The remote control sensor is exposed to strong light from a fluorescent lamp, etc.
The main unit is hot.		The main unit radiates heat and some of the parts may become hot. This is not a problem for performance or quality. Set up in a location with good ventilation. Do not cover the ventilation holes of the TV with a tablecloth, etc., and do not place on top of other equipment.
There may be red spots, blue spots, green spots and black spots on the screen.		This is a characteristic of liquid crystal panels and is not a problem. The liquid crystal panel is built with very high precision technology giving you fine picture details. Occasionally, a few non-active pixels may appear on the screen as fixed points of red, blue, green, or black. Please note this does not affect the performance of your LCD.

CUSTOMER SERVICES DIRECTORY (for U.S.A.)

Customer Services Directory

Obtain Product Information and Operating Assistance; locate your nearest Dealer or Servicenter; purchase Parts and Accessories; or make Customer Service and Literature requests by visiting our Web Site at:

<http://www.panasonic.com/consumersupport>

or, contact us via the web at:

<http://www.panasonic.com/contactinfo>

You may also contact us directly at:

1-800-211-PANA (7262)

Monday-Friday 9 am-9 pm; Saturday-Sunday 10 am-7 pm, EST.

For hearing or speech impaired TTY users, TTY : 1-877-833-8855

Accessory Purchases

Purchase Parts, Accessories and Instruction Books on line for all Panasonic Products by visiting our Web Site at:

<http://www.pasc.panasonic.com>

or, send your request by E-mail to:

npcparts@us.panasonic.com

You may also contact us directly at:

1-800-332-5368 (Phone) 1-800-237-9080 (Fax Only) (Monday - Friday 9 am to 8 pm, EST.)

Panasonic Services Company

20421 84th Avenue South,

Kent, WA 98032

(We Accept Visa, MasterCard, Discover Card, American Express, and Personal Checks)

For hearing or speech impaired TTY users, TTY : 1-866-605-1277

Service in Puerto Rico

Panasonic Puerto Rico, Inc.

Ave. 65 de Infantería, Km. 9.5, San Gabriel Industrial Park,

Carolina, Puerto Rico 00985

Phone (787)750-4300, Fax (787)768-2910

Specifications

	TC-20LA5	TC-20LE5
Power Source	AC 120 V, 60 Hz	
Power Consumption	Average use : 56 W (Maximum Current 1.3 A) Stand-by condition : 0.11 W Power off : 0.10 W	
LCD	640 × 480 pixels 4:3 aspect ratio LCD panel	
Screen Size (W × H × diagonal)	15.9 " × 11.9 " × 19.9 " (406.0 mm × 304.5 mm × 507.6 mm)	
Channel Capability	VHF-12 : UHF-56 : Cable-125	
Sound		
Speaker	5 cm × 9 cm, 2 pcs, 16 Ω	
Speaker Output	6 W [3 W + 3 W] (10%THD)	
Headphones	M3 (3.5 mm) Jack × 1	
FEATURES		
	3D Y/C Digital Comb Filter	
	CLOSED CAPTION	V-Chip
Operating Conditions	Temperature : 41 °F - 95 °F (5 °C – 35 °C) Humidity : 5 % - 90 % RH (non-condensing)	
Connection Terminals		
INPUT	VIDEO (RCA PIN Type × 1) × 2	1.0 Vp-p (75 Ω)
	S-VIDEO (MINI DIN 4pin × 1) × 2	Y : 1.0 Vp-p (75 Ω), C : 0.286 Vp-p (75 Ω)
	AUDIO L-R (RCA PIN Type × 2) × 2	0.5 Vrms
COMPONENT VIDEO INPUT	Y × 1	1.0 Vp-p (including synchronization)
	P _B / P _R × 1	±0.35 Vp-p
	AUDIO L-R (RCA PIN Type × 2) × 1	0.5 Vrms
Dimensions (W × H × D)		
Including TV Stand	19.6 " (498 mm) ×	19.6 " (498 mm) ×
	19.9 " (506.2 mm) ×	17.6 " (447.9 mm) ×
	10.2 " (260 mm)	7.2 " (184.6 mm)
TV Set Only	19.6" (498 mm) × 17.7 " (450.2 mm) × 3.6 " (93 mm)	19.6" (498 mm) × 17.9 " (454.8 mm) × 3.6 " (93 mm)
Mass (Weight)	15.4 lb. (7.0 kg) Net	12.8 lb. (5.8 kg) Net

Note:

Design and specifications are subject to change without notice. Weight and dimensions shown are approximate.

Customer's Record

The model number and serial number of this product can be found on its back cover. You should note this serial number in the space provided below and retain this book, plus your purchase receipt, as a permanent record of your purchase to aid in identification in the event of theft or loss, and for Warranty Service purposes.

Model Number _____

Serial Number _____

**Panasonic Consumer Electronics
Company, Division of Panasonic
Corporation of North America**
One Panasonic Way Secaucus
New Jersey 07094

Panasonic Puerto Rico Inc.
Ave. 65 de Infanteria, Km 9.5
San Gabriel Industrial Park,
Carolina, Puerto Rico 00985

Panasonic Canada Inc.
5770 Ambler Drive
Mississauga, Ontario
L4W 2T3