

# Panasonic®

Operating Instructions  
37" Class 1080p LCD HDTV  
(37.0 inches measured diagonally)

Manual de instrucciones  
Televisión de alta definición de 1080p y clase 37" de LCD  
(37,0 pulgadas medidas diagonalmente)

Model No. **TC-37LZ85**  
Número de modelo

## Quick Start Guide

(See page 6-14)

## Guía de inicio rápido

(vea la página 6-14)



- For assistance (U.S.A.), please call:  
**1-800-211-PANA (7262)**  
or visit us at [www.panasonic.com/contactinfo](http://www.panasonic.com/contactinfo)
- For assistance (Puerto Rico), please call:  
**787-750-4300**  
or visit us at [www.panasonic.com](http://www.panasonic.com)
- For assistance (Canada), please call:  
**1-866-330-0014**  
or visit us at [www.vieraconcierge.ca](http://www.vieraconcierge.ca)
- Para solicitar ayuda (EE.UU.), llame al:  
**1-800-211-PANA (7262)**  
ó visítenos en [www.panasonic.com/contactinfo](http://www.panasonic.com/contactinfo)
- Para solicitar ayuda (Puerto Rico), llame al:  
**787-750-4300**  
ó visítenos en [www.panasonic.com](http://www.panasonic.com)

**HDMI™**  
HIGH-DEFINITION MULTIMEDIA INTERFACE

**HDTV**

**SD  
HG**

**VIERA Link™**

**English**

Please read these instructions before operating your set and retain them for future reference. The images shown in this manual are for illustrative purposes only.

**Español**

Lea estas instrucciones antes de utilizar su televisor y guárdelas para consultarlas en el futuro. Las imágenes mostradas en este manual tienen solamente fines ilustrativos.

TQB2AA0775

Turn your own living room into a movie theater!  
**Experience an amazing level of multimedia excitement**



SDHC Logo is a trademark.



GalleryPlayer®

GalleryPlayer and the GalleryPlayer Logo are trademarks of GalleryPlayer, Inc.

**HDAVI Control™**

HDAVI Control™ is a trademark of Matsushita Electric Industrial Co., Ltd.



HDMI, the HDMI logo and High-Definition Multimedia Interface are trademarks or registered trademarks of HDMI Licensing LLC.



VIERA Link™ is a trademark of Matsushita Electric Industrial Co., Ltd.

# Contents

## Please read before using the unit

- Safety Precautions ..... 4

## Quick Start Guide

- Accessories/Optional Accessory ..... 6
- Basic Connection..... 8
- Identifying Controls ..... 12
- First Time Setup ..... 13

## Enjoy your TV!

### Basic Features

- Watching TV ..... 15
- Viewing from SD Card ..... 18
- Watching Videos and DVDs ..... 20

### Advanced Features

- How to Use Menu Functions  
(picture, sound quality, etc.) ..... 22
- VIERA Link™ "HDMI Control™" ..... 26
- Lock ..... 30
- Editing and Setting Channels ..... 32
- Closed Caption ..... 34
- Input Labels ..... 35
- Using Timer ..... 36
- Recommended AV Connections ..... 37

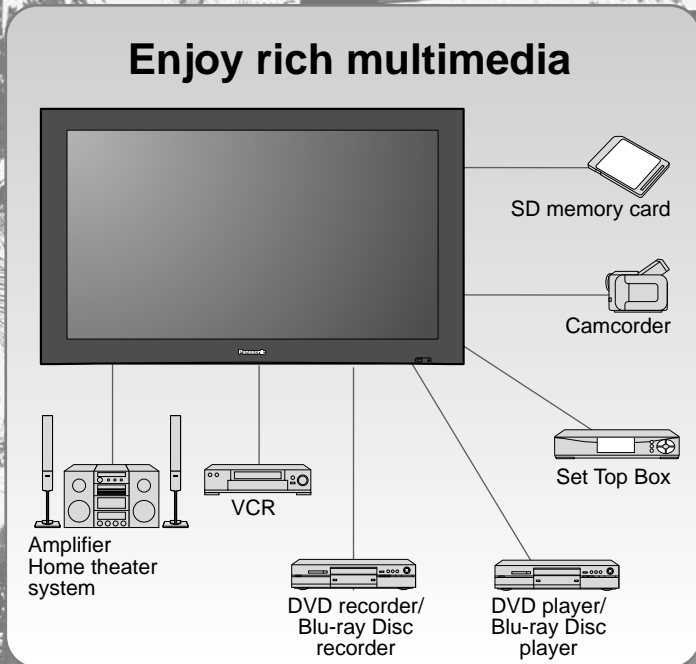

### FAQs, etc.

- Ratings List for Lock ..... 39
- Technical Information ..... 40
- Care and Cleaning ..... 43
- FAQ ..... 44
- Specifications ..... 46
- Limited Warranty (for U.S.A.) ..... 47
- Customer Services Directory (for U. S. A.) ... 48
- Limited Warranty (for Canada) ..... 49

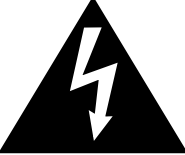

<p>Manufactured under license from Dolby Laboratories. DOLBY and the double-D symbol are trademarks of Dolby Laboratories.</p>	
<p><b>EZ Sync™</b></p> <p>EZ Sync™ is a trademark of Matsushita Electric Industrial Co., Ltd.</p>	

# Safety Precautions

	<b>CAUTION</b> <b>RISK OF ELECTRIC SHOCK</b> <b>DO NOT OPEN</b>	
<b>WARNING: To reduce the risk of electric shock, do not remove cover or back. No user-serviceable parts inside. Refer servicing to qualified service personnel.</b>		

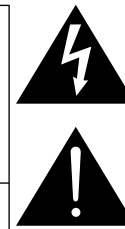

The lightning flash with arrowhead within a triangle is intended to tell the user that parts inside the product are a risk of electric shock to persons.

The exclamation point within a triangle is intended to tell the user that important operating and servicing instructions are in the papers with the appliance.

## Note to CATV System Installer

This reminder is provided to direct the CATV system installer's attention to Article 820-40 of the NEC that provides guidelines for proper grounding and, in particular, specifies that the cable ground shall be connected to the grounding system of the building, as close to the point of cable entry as practical.

## Secure Ventilation

Slots and openings in the cabinet and the back or bottom are provided for ventilation, and to ensure reliable operation of the LCD TV and to protect it from overheating. These openings must not be blocked or covered. There should be at least 10 cm of space from these openings. The openings should never be blocked by placing the LCD TV on a bed, sofa, rug or other similar surface. This LCD TV should not be placed in a built-in installation such as a bookcase unless proper ventilation is provided.

## Important Safety Instructions

- 1) Read these instructions.
- 2) Keep these instructions.
- 3) Heed all warnings.
- 4) Follow all instructions.
- 5) Do not use this apparatus near water.
- 6) Clean only with dry cloth.
- 7) Do not block any ventilation openings. Install in accordance with the manufacturer's instructions.
- 8) Do not install near any heat sources such as radiators, heat registers, stoves, or other apparatus (including amplifiers) that produce heat.
- 9) Do not defeat the safety purpose of the polarized or grounding-type plug. A polarized plug has two blades with one wider than the other. A grounding type plug has two blades and a third grounding prong. The wide blade or the third prong are provided for your safety. If the provided plug does not fit into your outlet, consult an electrician for replacement of the obsolete outlet.
- 10) Protect the power cord from being walked on or pinched particularly at plugs, convenience receptacles, and the point where they exit from the apparatus.
- 11) Only use attachments / accessories specified by the manufacturer.
- 12) Use only with the cart, stand, tripod, bracket, or table specified by the manufacturer, or sold with the apparatus. When a cart is used, use caution when moving the cart / apparatus combination to avoid injury from tip-over.
- 13) Unplug this apparatus during lightning storms or when unused for long periods of time.
- 14) Refer all servicing to qualified service personnel. Servicing is required when the apparatus has been damaged in any way, such as power-supply cord or plug is damaged, liquid has been spilled or objects have fallen into the apparatus, the apparatus has been exposed to rain or moisture, does not operate normally, or has been dropped.
- 15) Operate only from the type of power source indicated on the marking label. If you are not sure of the type of power supplied to your home consult your television dealer or local power company.
- 16) Follow all warnings and instructions marked on the LCD TV.
- 17) Never push objects of any kind into this LCD TV through cabinet slots as they may touch dangerous voltage points or short out parts that could result in a fire or electric shock. Never spill liquid of any kind on the LCD TV.
- 18) If an outside antenna is connected to the television equipment, be sure the antenna system is grounded so as to provide some protection against voltage surges and built up static charges. In the U.S. Section 810-21 of the National Electrical Code provides information with respect to proper grounding of the mast and supporting structure, grounding of the lead-in wire to an antenna discharge unit, size of grounding conductors, location of antenna discharge unit, connection to grounding electrodes, and requirements for the grounding electrode.

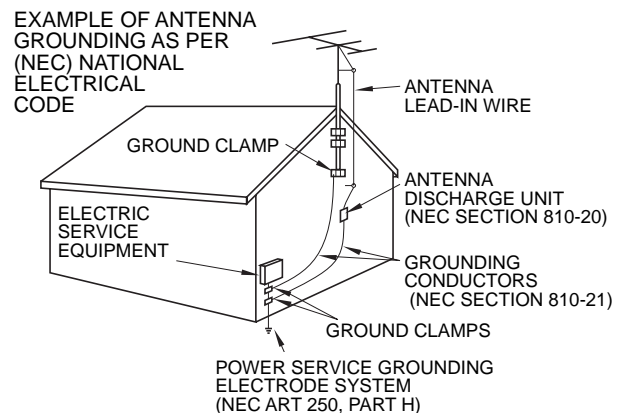

- 19) An outside antenna system should not be located in the vicinity of overhead power lines, other electric light, power circuits, or where it can fall into such power lines or circuits. When installing an outside antenna system, extreme care should be taken to keep from touching such power lines or circuits as contact with them might be fatal.
- 20) Unplug this LCD TV from the wall outlet and refer servicing to qualified service personnel under the following conditions:
- When the power cord or plug is damaged or frayed.
  - If liquid has been spilled into the LCD TV.
  - If the LCD TV has been exposed to rain or water.
  - If the LCD TV does not operate normally by following the operating instructions.  
Adjust only those controls that are covered by the operating instructions as improper adjustment of other controls may result in damage and will often require extensive work by a qualified technician to restore the LCD TV to normal operation.
  - If the LCD TV has been dropped or the cabinet has been damaged.
  - When the LCD TV exhibits a distinct change in performance - this indicates a need for service.
- 21) When replacement parts are required, be sure the service technician uses replacement parts specified by the manufacturer that have the same characteristics as the original parts. Unauthorized substitutions may result in fire, electric shock, or other hazards.
- 22) **WARNING: TO REDUCE THE RISK OF FIRE OR ELECTRIC SHOCK, DO NOT EXPOSE THIS APPARATUS TO RAIN, MOISTURE, DRIPPING OR SPLASHING. DO NOT PLACE LIQUID CONTAINERS (FLOWER VASES, CUPS, COSMETICS, ETC.) ABOVE THE SET (INCLUDING ON SHELVES ABOVE, ETC.).**
- 23) **WARNING: SMALL PARTS CAN PRESENT CHOKING HAZARD IF ACCIDENTALLY SWALLOWED. KEEP SMALL PARTS AWAY FROM YOUNG CHILDREN. DISCARD UNNEEDED SMALL PARTS AND OTHER OBJECTS, INCLUDING PACKAGING MATERIALS AND PLASTIC BAGS/SHEETS TO PREVENT THEM FROM BEING PLAYED WITH BY YOUNG CHILDREN, CREATING THE POTENTIAL RISK OF SUFFOCATION.**
- 24) **CAUTION:** TO PREVENT ELECTRIC SHOCK, DO NOT USE THIS PLUG WITH A RECEPTACLE OR OTHER OUTLET UNLESS THE BLADES CAN BE FULLY INSERTED TO PREVENT BLADE EXPOSURE.
- 25) **CAUTION:** USE WITH OTHER STAND MAY RESULT IN INSTABILITY POSSIBLY CAUSING INJURY.
- 26) **CAUTION:** DANGER OF EXPLOSION IF BATTERY IS INCORRECTLY REPLACED. REPLACE ONLY WITH THE SAME OR EQUIVALENT TYPE.
- 27) **CAUTION: This LCD TV is for use only with the following optional accessory. Use with any other type of optional accessories may cause instability which could result in the possibility of injury.**  
(All of the following accessories are manufactured by Matsushita Electric Industrial Co., Ltd.)
- Wall-hanging bracket (Vertical): TY-WK32LR2W
- Always be sure to ask a qualified technician to carry out set-up.

**NOTE:** This equipment is designed to operate in North America and other countries where the broadcasting system and AC house current are exactly the same as in North America.

## FCC STATEMENT

This equipment has been tested and found to comply with the limits for a TV Broadcast Receiver, pursuant to Part 15 of the FCC Rules. These limits are designed to provide reasonable protection against harmful interference in a residential installation. This equipment generates, uses and can radiate radio frequency energy and, if not installed and used in accordance with the instructions, may cause harmful interference to radio communications. However, there is no guarantee that interference will not occur in a particular installation. If this equipment does cause or receive interference, which can be determined by turning equipment off and on, the user is encouraged to try to correct the interference by one or more of the following measures:

Reorient or relocate the TV antenna.  
Increase the separation between TV and other equipment.  
Connect TV into separate outlet from other equipment.  
Consult the dealer or an experienced radio / TV technician for help.

**FCC Caution:** Any changes or modifications not expressly approved by the party responsible for compliance could void the user's authority to operate this equipment.

# Accessories/Optional Accessory

## Accessories

Check you have all the items shown.

### Accessories

- Remote Control Transmitter  
● N2QAYB000221



- Batteries for the Remote Control Transmitter (2)  
● AA Battery

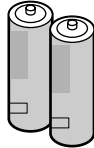

- Cleaning cloth

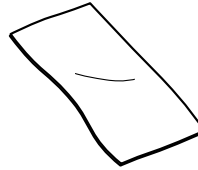

- Operating Instructions  
 Notice sheet (Demo mode)  
 Quick Setup Guide (For viewing HD Programming)  
 Product Registration Card (U. S. A)  
 Customer Care Plan Card (U. S. A)

### Optional Accessory

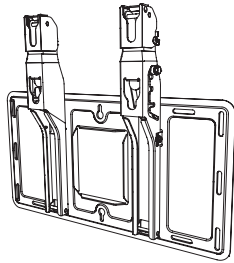

#### Wall-hanging bracket

(vertical)  
● TY-WK32LR2W

Please contact your nearest Panasonic dealer to purchase the recommended wall-hanging bracket. For additional details, please refer to the wall-hanging bracket installation manual.

## Installing the remote's batteries

1

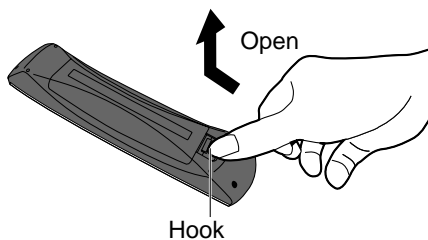

2

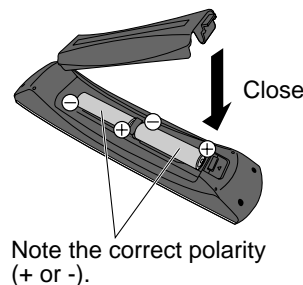

#### Caution

- Incorrect installation may cause battery leakage and corrosion, resulting in damage to the remote control.
- Do not mix old and new batteries.
- Do not mix different battery types (such as alkaline and manganese batteries).
- Do not use rechargeable (Ni-Cd) batteries.
- Do not burn or break batteries.

## Location

Place the TV at a comfortable distance for viewing. Avoid placing it where sunlight or other bright light (including reflections) will fall on the screen.

Use of some types of fluorescent lighting can reduce remote control transmitter range.

Adequate ventilation is essential to prevent an internal component failure. Keep away from areas of excessive heat or moisture.

## Preparation for Wall-hanging

Before mounting the TV on the wall, you must remove the TV-Stand from the TV.  
Follow the steps below:

**1** Disconnect all the cables from the TV.

**2** Remove the TV-Stand.

Ⓐ Remove four screws

Ⓑ Pull out the TV-Stand

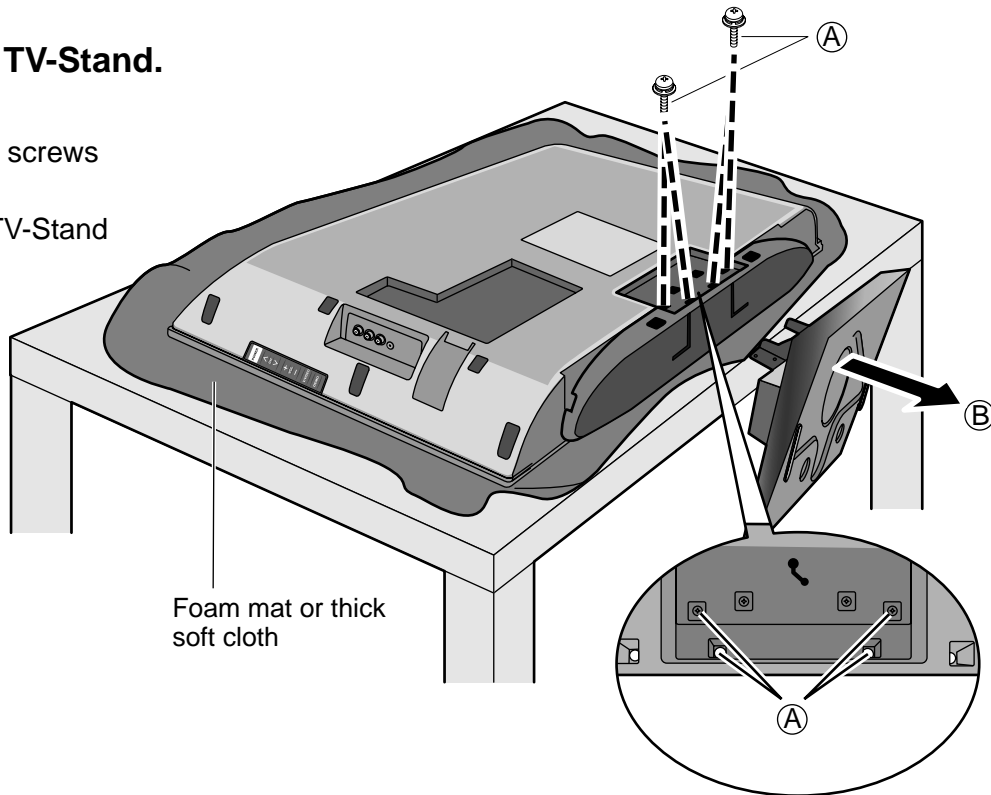

### WARNING

- Failure to use a Panasonic bracket or choosing to mount the unit yourself will be done at the risk of the consumer. Any damage resulting from not having a professional installer mount the unit will void your unit's warranty.
- Always be sure to ask a qualified technician to carry out set-up. Incorrect fitting may cause equipment to fall, resulting in injury and product damage.
- Do not mount this LCD Television directly below ceiling lights (such as spotlights, floodlights, or halogen lights) which typically give off high heat. Doing so may warp or damage plastic cabinet parts.

## Reference of connection

### Antenna terminal

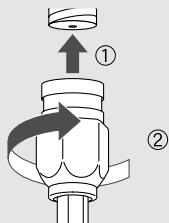

- Firmly tighten by hand.

### Pin terminals

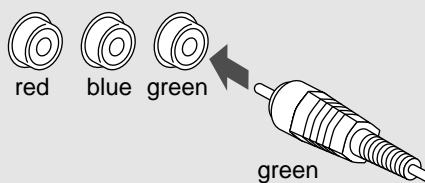

- Match colors of plugs and terminals.
- Insert firmly.

### HDMI terminal

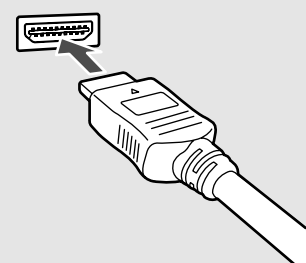

- Insert firmly.

# Basic Connection

## Example 1 Connecting Antenna (To watch TV)

TV

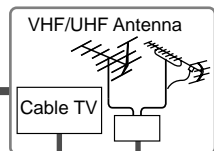

### VHF/UHF Antenna

- NTSC (National Television System Committee): Conventional broadcasting
- ATSC (Advanced Television Systems Committee): Digital TV Standards include digital high-definition television (HDTV), standard-definition television (SDTV), data broadcasting, multi-channel surround-sound audio and interactive television.

## To connect the antenna terminal and Cable Box

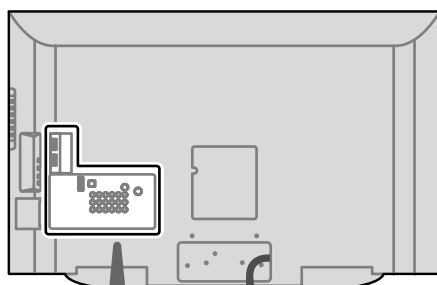
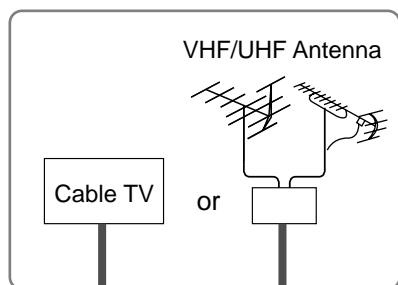

AC 120 V  
60 Hz

Power Cord  
(Connect after all the other connections.)

Back of the TV

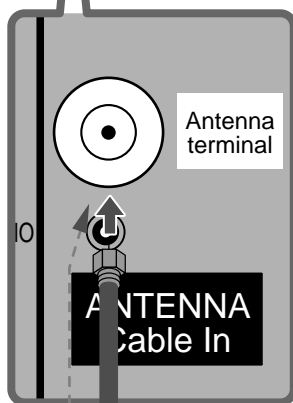

(If no Cable Box)

or

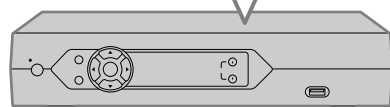
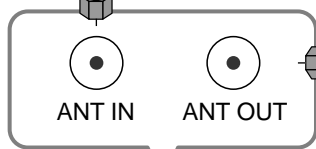

Cable Box

### Cable Box/Cable

- You need to subscribe to a cable TV service to enjoy viewing their programming.
- You can enjoy high-definition programming by subscribing to a high-definition cable service.  
The connection for high-definition can be done with the use of HDMI or Component Video cable.
- If using a Cable Box set the TV channel to CH3 or CH4 for regular cable.
- To view high-definition programming select the correct video input.

### Note

- All cables and external equipment shown in this book are not supplied with the TV.
- For the details of the external equipment's connections, please refer to the operating manuals for the equipment.
- For additional assistance, visit us at: [www.panasonic.com](http://www.panasonic.com)  
[www.panasonic.ca](http://www.panasonic.ca)



## Example 2 Connecting DVD recorder (VCR) (To record/playback)

TV



AV Equipment  
(e.g. DVD Recorder  
or VCR)

VHF/UHF Antenna

DVD Recorder

If this source has higher resolution through interlace or progressive signal, connection can be done with the use of Component Video or HDMI cable.

VCR

Connection can be done with the use of an RF cable and Composite Video/S Video cable.

### To connect the antenna terminal and DVD recorder or VCR

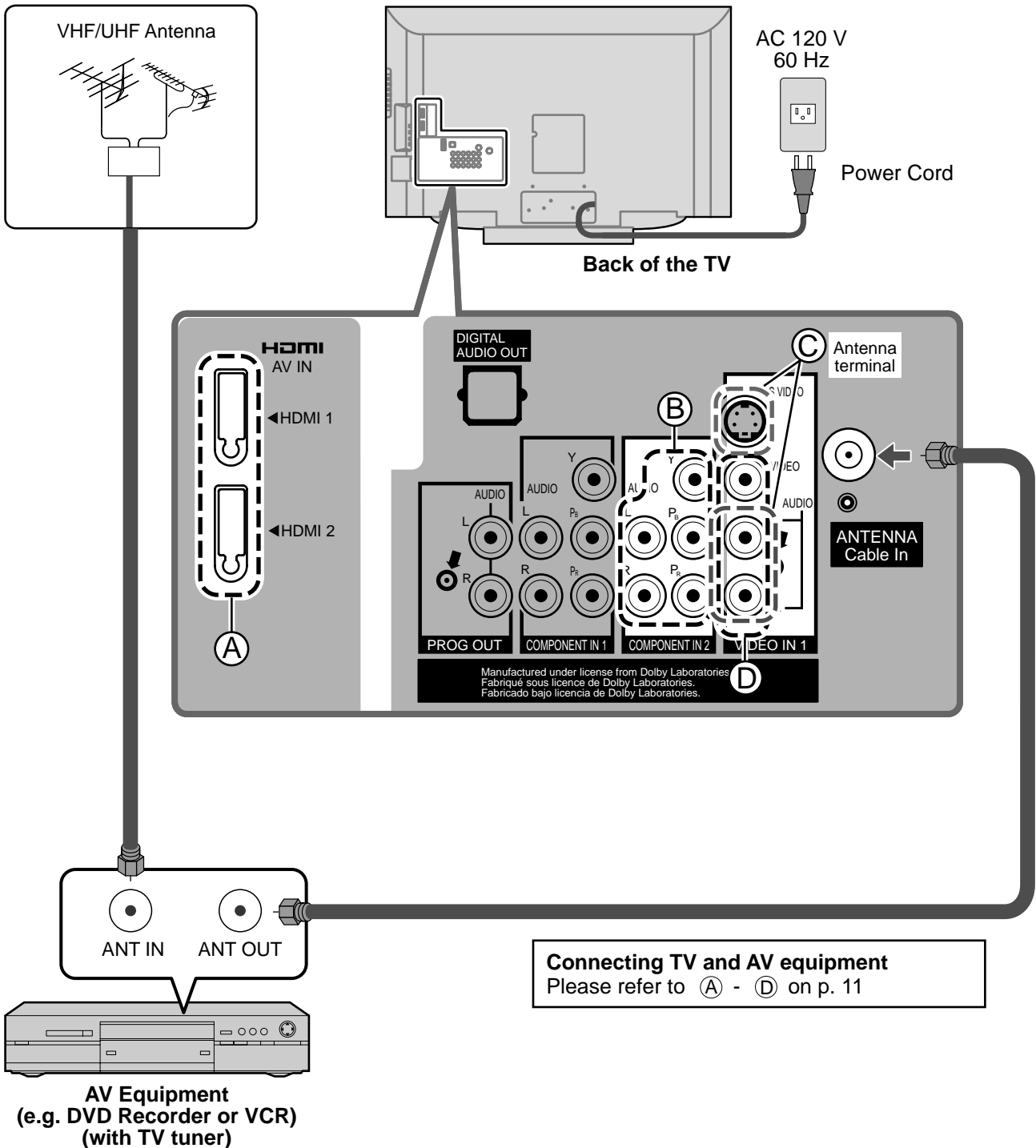

# Basic Connection (Continued)

## Example 3 Connecting DVD recorder (VCR) and satellite receiver

TV

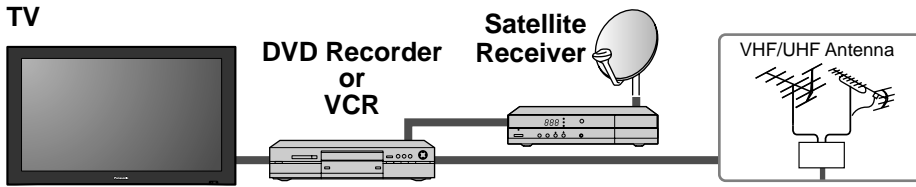

You can enjoy high-definition programming by subscribing to high-definition satellite service. Connection can be done with the use of HDMI or Component Video cable.

### To connect the antenna terminal and Satellite Receiver and DVD recorder or VCR

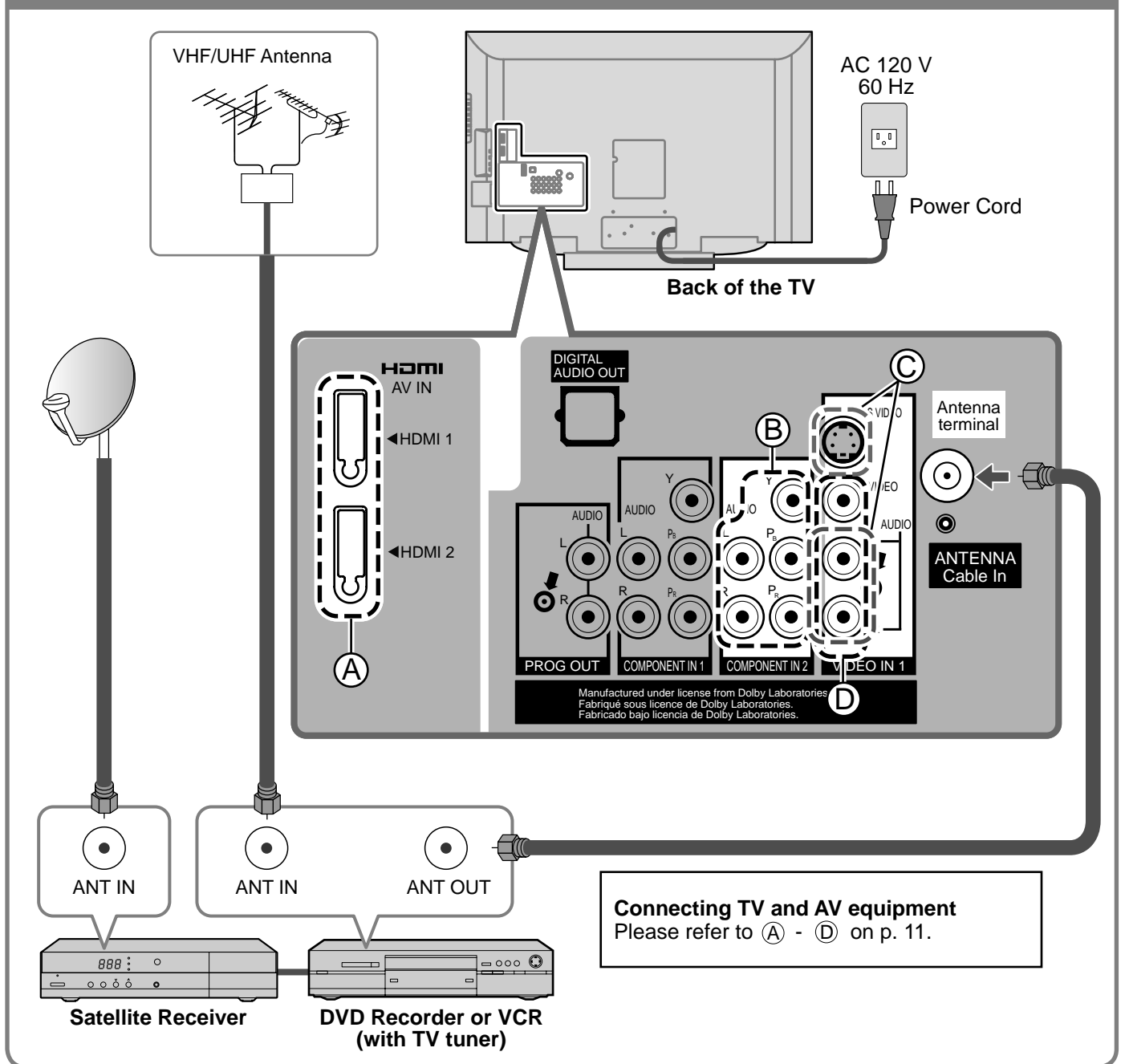

#### Note

- For details of external equipment connections, please refer to the operating manuals for the equipment.

## AV cable connections

High-Definition

### A To use HDMI terminals

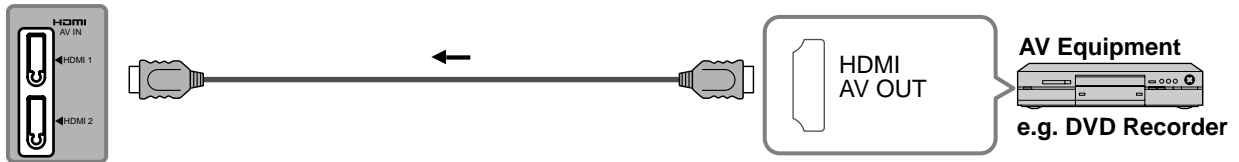

- Connecting to HDMI terminals will enable you to enjoy high-definition digital images and high-quality sound.
- For "VIERA Link™ connections", please refer to p. 38.

### B To use COMPONENT terminals

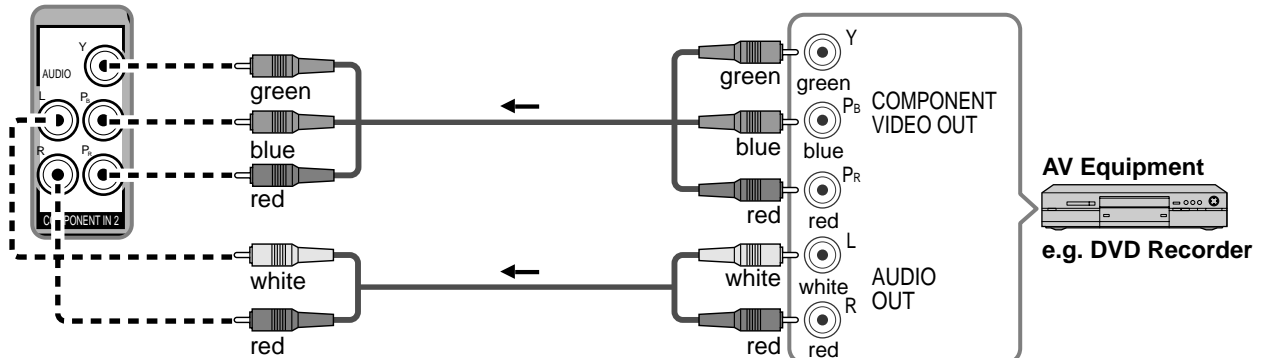

- Recorders may also be connected to COMPOSITE or S VIDEO terminals. (see below)

Standard-Definition

### C To use S VIDEO terminals

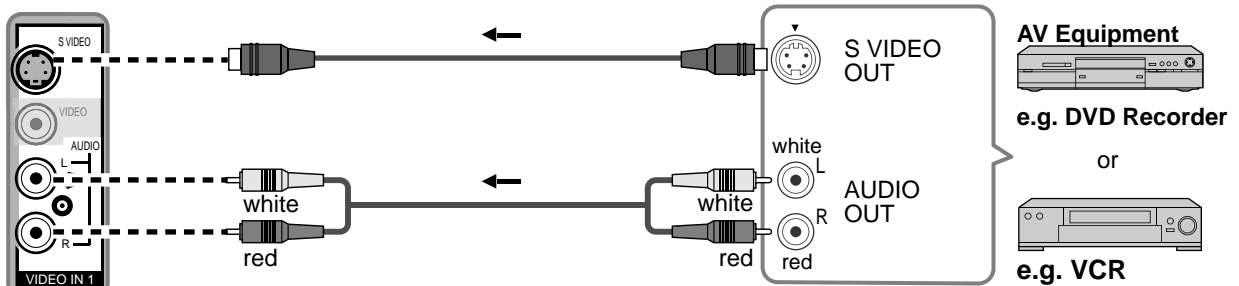

### D To use COMPOSITE terminals

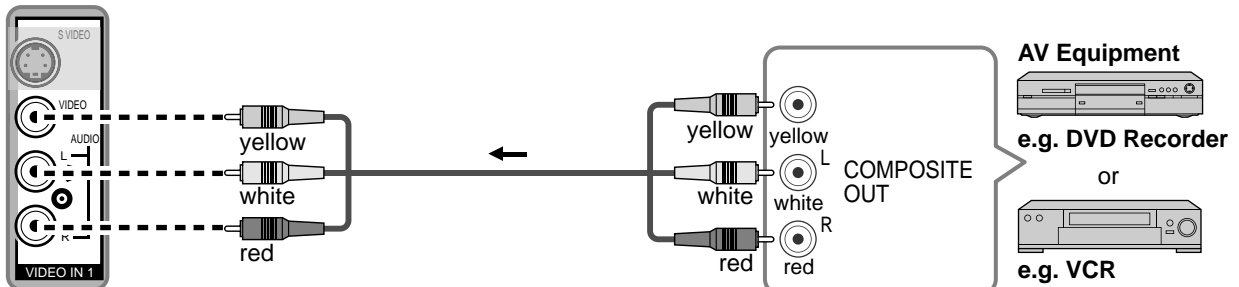

- The S Video input will override the composite video signal when S Video cable is connected. Connect either S Video or Video cable.
- Connecting to S VIDEO terminals will enable you to enjoy greater picture quality than using Composite terminals.

#### Note

- Some programs contain a copyright protection signal to prevent recording.
- When the copyright protection program is displayed, do not connect the other TV monitor through a VCR. Video signals fed through VCRs may be affected by copyright protection systems and the picture will be distorted on the other TV monitor.
- For the details of the external equipment's connections, please refer to the operating manuals for the equipment.

Quick Start Guide

● Basic Connection (AV cable connections) (TV + DVD Recorder or VCR + Satellite Receiver)

# Identifying Controls

## TV controls/indicators

### Front of the TV

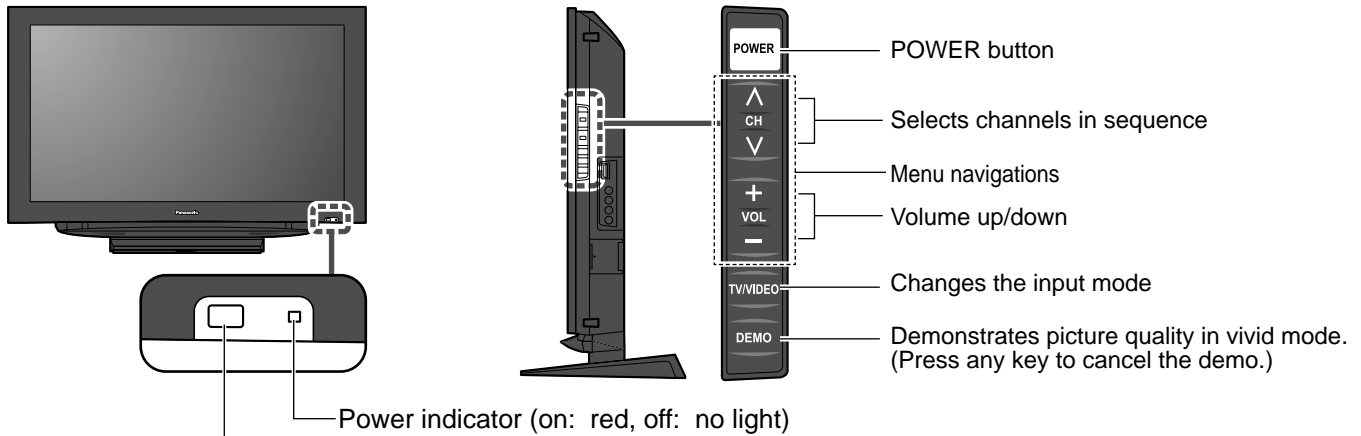

Remote control sensor  
Within about 23 feet (7 meters) in front of the TV set.

#### Note

- The TV consumes a limited amount of power as long as the power cord is inserted into the wall outlet.

## Remote controls

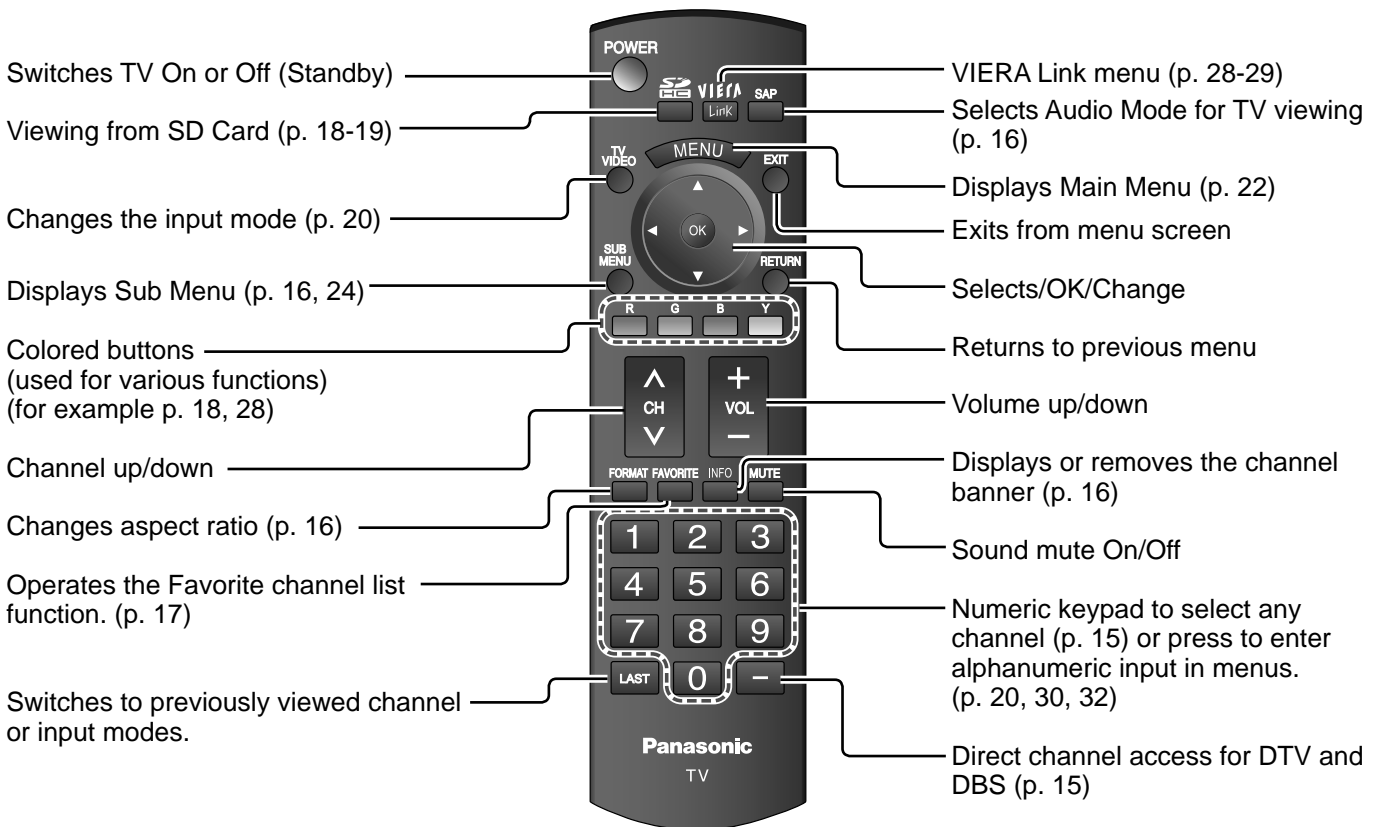

# First Time Setup

“First time setup” is displayed only when the TV is turned on for the first time after the power cord is inserted into a wall outlet and when “Auto power on” (p. 24-25) is set to “No”.



## 1 Turn the TV On with the POWER button

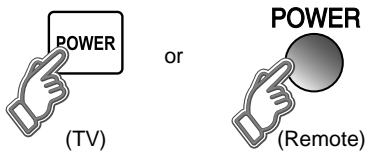

■ Press to exit from a menu screen



■ Press to return to the previous screen



### Note

- To change setting (Language/Clock/ Auto program) later, go to Menu screen (p. 24)

## Be sure to select “Home” (Normal display mode)

Select your viewing environment

Home Store

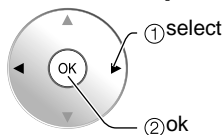

- This setting will be skipped next time.
- If you select “Store”, “First time setup” will not be displayed. In case you select “Store” by mistake, unplug the TV and plug it again. Then, set to “Home” next time.
- This selection screen is displayed when “Store” is selected.

## 2 Select your language

First time setup

Language  
Clock  
Auto program

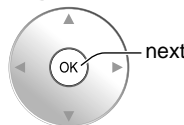

Language

Language English

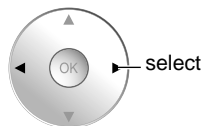

→English ↔ Español ↔ Français←

RETURN



Go back to previous screen.

## 3 Adjust the clock

First time setup

Language  
Clock  
Auto program

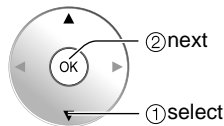

Clock

Year 2008  
Month 1  
Day 7  
Hour 10 AM  
Minute 10



RETURN



Go back to previous screen.

- Year: Select the year
- Month: Select the month
- Day: Select the day
- Hour: Adjust the hour
- Minute: Adjust the minute

# First Time Setup (Continued)

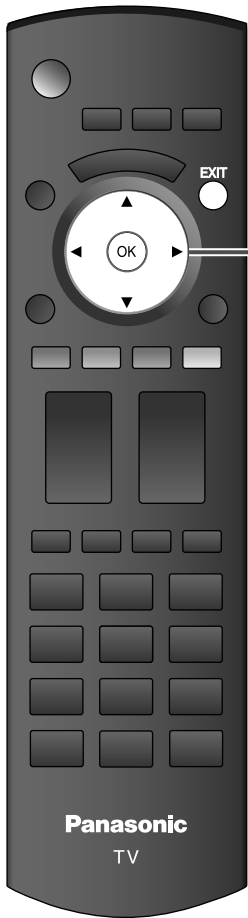

## 4 Auto channel setup

### ① Select "Auto program"

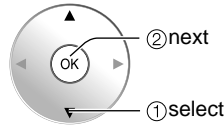
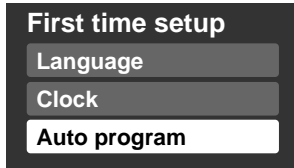

### ② Select "ANT in"

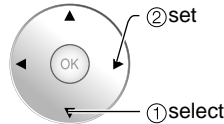
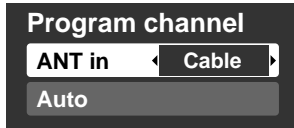

**ANT in**  
Cable: Cable TV  
Antenna: Antenna

### ③ Select "Auto"

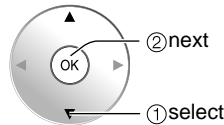
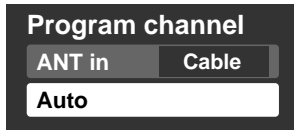

### ④ Select scanning mode (ALL channels/Analog only/Digital only)

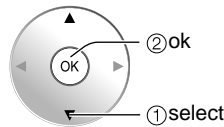

■ Press to exit from a menu screen

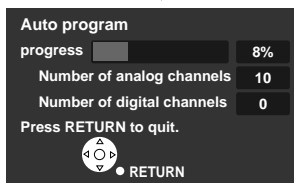

### Start scanning the channels

- Available channels (analog/digital) are automatically set.

All channels: Scans digital and analog channels  
Analog only: Scans Analog channels only  
Digital only: Scans Digital channels only

### ⑤ Confirm registered channels

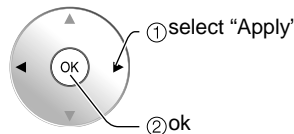
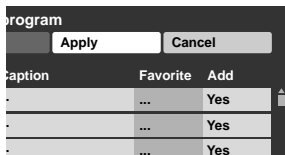

- If OK is not pressed after selecting "Apply", the channels will not be saved. The channel will be saved when no operation is performed for 60 seconds and the "Manual program" menu will also exit automatically.
- If you perform scanning more than twice, previously saved channels are erased.

### Note

- About broadcasting systems

**Analog (NTSC):** Conventional broadcasting

**Digital (ATSC):** New programming that allows you to view more channels featuring high-quality video and sound

# Watching TV

Connect the TV to a cable box/cable, set-top-box, satellite box, or antenna cable (p. 8-11)

## To watch TV and other functions



1

### Turn power on

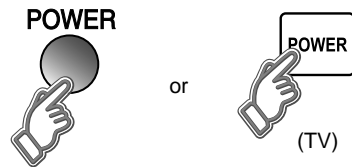

#### Note

- If the mode is not TV, press and select TV. (p. 20)

2

### Select a channel number

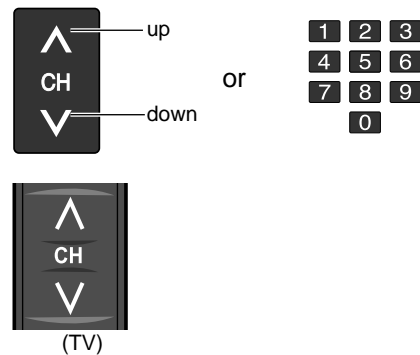

#### ■ To directly input the digital channel number

- When tuning to a digital channel, press the button to enter the minor number in a compound channel number.

example: CH15-1:

#### Note

- Reselect "Cable" or "Antenna" in "ANT in" of "Program channel" to switch the signal reception between cable TV and antenna. (p. 14, 33)
- The channel number and volume level remain the same even after the TV is turned off.

# Watching TV (Continued)

## Other Useful Functions (Operate after ②)

**Listen with SAP (Secondary Audio Program)**

### Select Audio Mode for watching TV



- Digital mode**  
 Press SAP to select the next audio track (if available) when receiving a digital channel.
 

Audio track 1 of 2  
(English)
- Analog mode**  
 Press SAP to select the desired audio mode.
  - Each press of SAP will change the audio mode. (Stereo/SAP/Mono)

**Display the SUB MENU**

- Press SUB MENU to show sub menu screen.** (p. 24)  
 This menu consists of shortcuts to convenient functions.

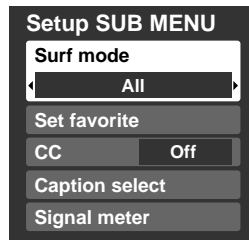

**Information Recall**

- Displays or removes the channel banner.**

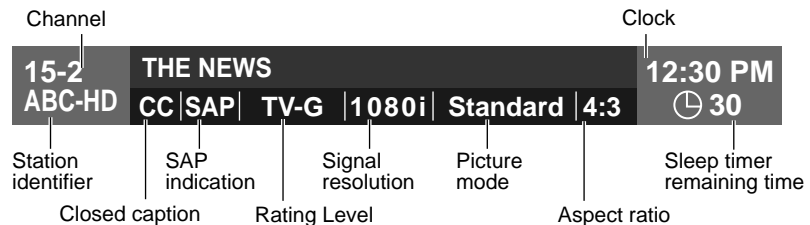

**Change aspect ratio**

- Press FORMAT to cycle through the aspect modes.** (p. 40)

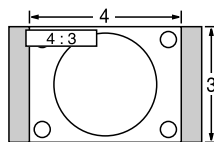

- 480i, 480p: FULL/JUST/4:3/ZOOM
- 1080p, 1080i, 720p: FULL/H-FILL/JUST/4:3/ZOOM

**Call up a favorite channel**



### FAVORITE

Channel numbers registered in Favorite are displayed on the favorite tune screen. Select the desired broadcast station with the cursor or use number buttons. (see p. 17)



## Favorite Feature

### ■ Set Favorite Feature

**1** Display the SUB MENU.

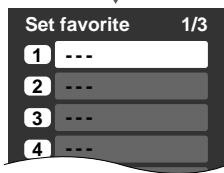
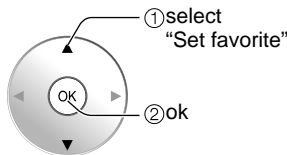
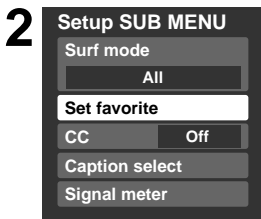
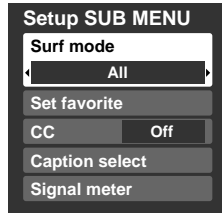

• Press FAVORITE repeatedly to change between pages (1/3, 2/3, 3/3, or exit).

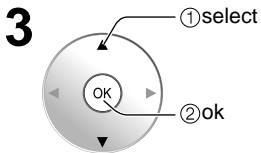

Press ▲▼ to highlight a position on the list. Then, press OK to save the displayed channel in that position.

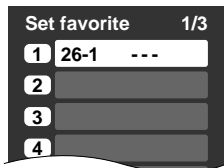

• You can also use the NUMBER buttons (1-9 and 0) to select a list number (1-9 and 0). By doing so, the displayed channel will be saved on that list number without pressing OK.

● **To delete a favorite channel**

A saved channel can be removed from the list by holding down OK while its position is highlighted.

● **To change the page**

Pressing ◀ changes the page backward.

Pressing ▶ changes the page forward.

### ■ Use Favorite Feature

**1** FAVORITE



Press FAVORITE.

• Press FAVORITE repeatedly to change between pages (1/3, 2/3, 3/3, or exit).

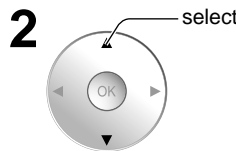
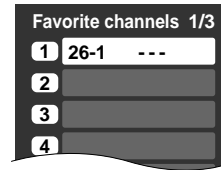

Press ▲▼ or a Numbered key (1-9 and 0) to highlight a channel on the list.

• Selecting a channel number from the list with the number button will display the channel directly.

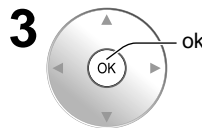

Press OK to display the highlighted channel.

# Viewing from SD Card

You can view photos taken with a digital camera or digital video camera and saved on an SD card.  
(Media other than SD Cards may not be reproduced properly.)

## Photo viewer

1

### Insert the SD card and select "Play SD card now"

- "SD card setting" will be displayed automatically each time a SD card is inserted for the first time.

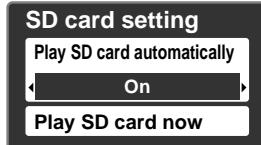

#### Play SD card automatically:

- Set it to playback the data when SD card is inserted.
- On:** When SD card is inserted the data plays automatically from next time.
- Off:** The data can be played manually.

### Press the SD key or select "SD card" on the Menu.

- You can skip this step when "Play SD card now" is selected or "On" is set in "Play SD card automatically" setting.



2

### Select the data to be viewed

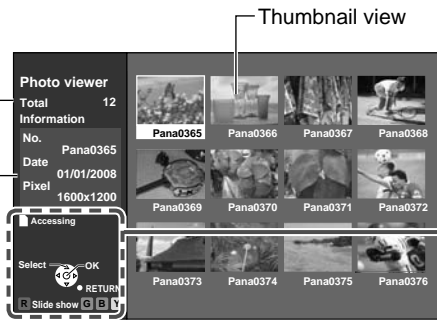

- Selected picture information is displayed.
- No.:** Image number or file name is displayed.
- Date:** Date of recording is displayed.
- Pixel:** Display resolution is displayed.

Total number of images

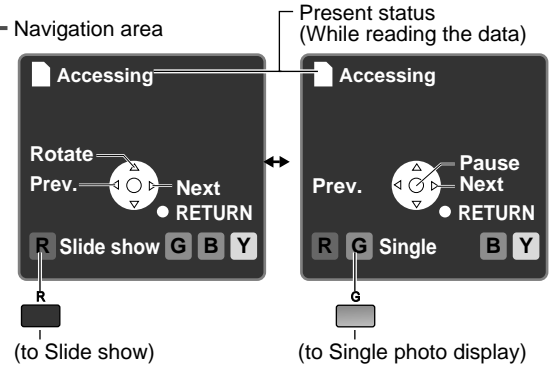
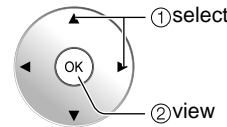

#### Press to exit from a menu screen



#### Press to return to the previous screen



#### Note

- Depending on the JPEG format, "Information" contents may not be displayed correctly. Refer to p. 41 (Data format for SD card browsing) for details.

3

### View



Displays one at a time

Navigation area

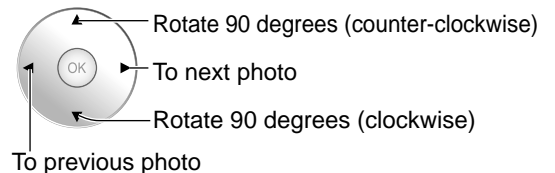

- To display/hide Navigation area → INFO

## SD Card

- Insert the card

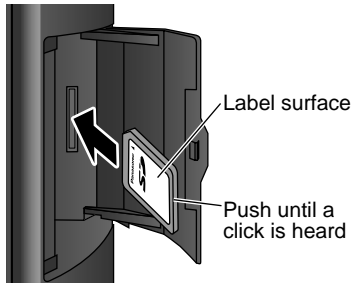

- Remove the card  
➔ Press in lightly on SD Card, then release.



- Compliant card type (maximum capacity): SDHC Card (16 GB), SD Card (2 GB), miniSD Card (1 GB) (requiring miniSD Card adapter)
- For cautions and details on SD Cards (p. 41)

## To change the view (slide show mode, adjusting images, etc.)

### ■ To setup slide show mode

In ② or ③

- 1 Display "Photo menu"

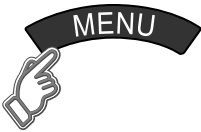

- 2 Select "Setup slide show"

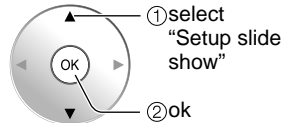
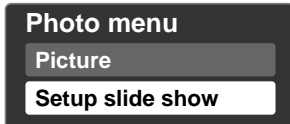

- 3 Select the item and adjust

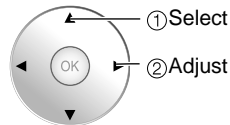

<b>Disp. time</b>	You can set how many seconds each image is displayed in Slide show mode. (1-10/15/20/30/45/60/120 sec)
<b>Repeat</b>	Turn the slide show Repeat function On or Off.

#### Note

- For large image sizes, the display time will be longer than the number of seconds set.
- To stop in mid-cycle ➔ Press **RETURN**

### ■ To adjust picture

In ② or ③

- 1 Display "Photo menu"



- 2 Select "Picture"

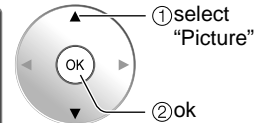
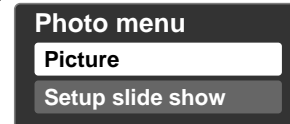

- 3 Select the item

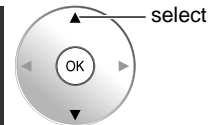

Picture menu (p. 22)

- 4 Adjust or select

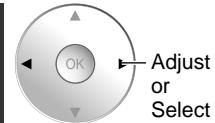
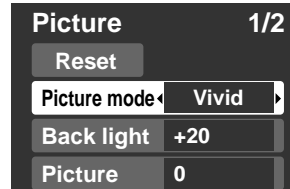

# Watching Videos and DVDs

If you have applicable equipment connected to the TV, you can watch videos and DVDs on the TV's screen.

## Input Select

You can select the external equipment to access.

**1** With the connected equipment turned On  
**Display the Input select menu**



**2** **Select the input mode**

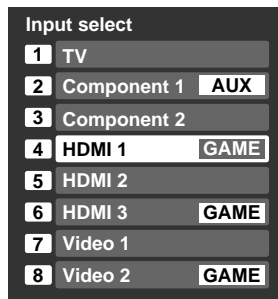

or

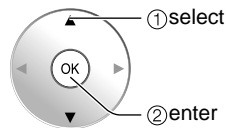

Press corresponding NUMBER button on the remote control to select the input of your choice.

Select the input of your choice, then press OK.

- During the selection, if no action is taken for several seconds, the "Input select" menu disappears.

- The terminal and label of the connected equipment are displayed. To label each of the inputs, please refer to p. 35.

(example)



### Note

- The input label will be displayed on "Input select" screen if Input label is set on p. 35.
- For side input terminals (HDMI 3/Video 2), "GAME" input label is set as default. (Picture mode is set to "Game", refer to p. 42.)
- For more details for picture mode setting, refer to p. 42. For Input label, refer to p. 35.

■ **To return to TV**



**3** **Operate the connected equipment using the remote control supplied with the equipment.**

### Note

- For details, see the manual for the connected equipment.

# VIERA Link™ Setting

If you connect equipment that has “HDAVI Control” function to a TV with HDMI cable, you can use more convenient functions. Please refer to p. 26-29. Before using these functions, you need to set “VIERA Link” setting to “On” as shown below.

**1 Display menu**

**2 Select “Setup”**

**3 Select “VIERA Link setting”**

**4 Select “VIERA Link”**

**5 Select “On”**  
(default is On)

Now you can set each “VIERA Link” functions according to your preference (p. 26-27).

■ Press to exit from a menu screen  
EXIT

■ Press to return to the previous screen  
RETURN

**Note**

- If no HDMI equipment is connected or standard HDMI equipment (non- “VIERA Link”) is used, set it to “Off”.
- For the details on the external equipment’s connections, please refer to the operating manuals for the equipment.

# How to Use Menu Functions

Various menus allow you to make settings for the picture, sound, and other functions so that you can enjoy watching TV best suited for you.



## 1 Display menu



- Displays the functions that can be set (varies depending on the input signal)

## 2 Select the menu

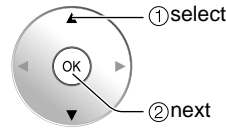
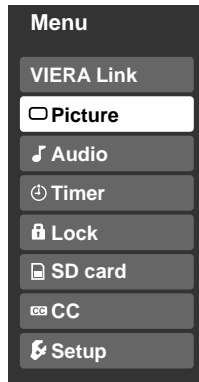

## 3 Select the item

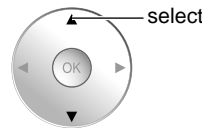
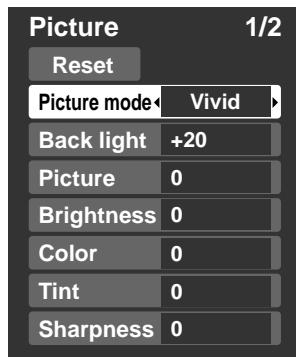

(example: Picture menu)

## 4 Adjust or select

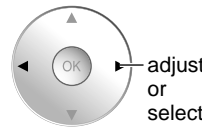
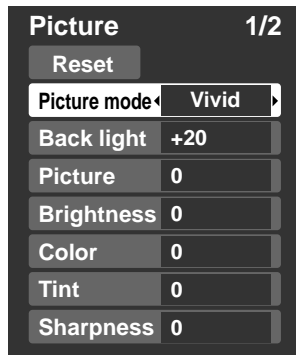

(example: Picture menu)

■ Press to exit from a menu screen



■ Press to return to the previous screen



## Menu list

Menu	Item		
VIERA Link	Record now		
	Stop recording		
	VIERA Link control		
	Speaker output		
	Reset		
	Picture mode		
	Back light		
	Picture, Brightness, Color, Tint, Sharpness		
	Color temp.		
	Color mgmt.		
Picture	x.v.Color		
	AI picture		
	Zoom adjust		
	Advanced picture	Video NR	
		3D Y/C filter	
		Color matrix	
		MPEG NR	
		Black level	
		HD size	
	Audio	Reset	
Bass			
Treble			
Balance			
Advanced audio		AI sound	
		Surround	
		Bass boost	
		Audio leveler	
		Speaker output	
		HDMI 1 in HDMI 2 in HDMI 3 in	
Timer	Sleep, Timer 1-5		
Lock			
SD Card	SD card		
CC	CC		

## Adjustments/Configurations (alternatives)

### [Record now/Stop recording]

Records programs on the recorder immediately with the TV's remote control (p. 28-29).

### [VIERA Link control]

Selects equipment to access and operate. **(Recorder/Home theater/Player/Camcorder)** (p.28-29)

### [Speaker output]

Selects an audio output. **(Home theater/TV)** (p. 28-29)

● VIERA Link menu is accessible directly by pressing the VIERA Link button on the remote control. →  (p. 28)

Resets all picture adjustments to factory default settings except for "Advanced picture".

**Reset**

Basic picture mode **(Vivid/Standard/Cinema/Game/Custom)** (p. 42)

**Picture mode** **Vivid**

Adjusts luminance of the back light.

**Back light** **+20**

Adjusts color, brightness, etc. for each picture mode to suit your taste

● Display range

**Picture/Brightness/Color/Sharpness:** 0 - 100

**Tint:** -50 - +50

**Picture** **+20**

**Tint** **0**

**Brightness** **0**

**Sharpness** **0**

**Color** **0**

Selects a choice of Cool(blue), Normal, or Warm(red) color. **(Cool/Normal/Warm)**

**Color temp.** **Cool**

On: Enhances green and blue color reproduction, especially outdoor scenes. **(On/Off)**

**Color mgmt.** **On**

Auto: Provide the appropriate picture when images corresponding to "x.v.Color" are input via the HDMI input of this TV. **(Off/Auto)**

**x.v.Color** **Auto**

Controls dark areas without affecting the black level or brightness in the overall picture **(On/Off)**

**AI picture** **On**

Adjusts vertical alignment and size when aspect setting is "ZOOM" (p. 40)

**Zoom adjust**

Reduces noise, commonly called snow. Leave it off when receiving a strong signal. **(Off/On)**

**Video NR** **Off**

Minimizes noise and cross-color in the picture. **(On/Off)**

**3D Y/C filter** **On**

Selects image resolution of component-connected devices **(HD/SD)**

● SD: Standard Definition HD: High Definition

● Only 480p signal accepted; regular TV (NTSC) is not available.

**Color matrix** **SD**

Reduces noise of specific digital signals of DVD, STB, etc. **(On/Off)**

**MPEG NR** **Off**

Selects Dark or Light. Valid only for external input signals. **(Dark/Light)**

**Black level** **Light**

Selects between 95 % (Size 1) or 100 % (Size 2) for the scanning area with High-definition signal. **(Size 1/ Size 2)**  
Select "Size 1" if noise is generated on the edges of the screen.

● Size 1: Selected item for "HD size". Scanning 95%

● Size 2: Selected item for "HD size". Scanning 100%

**HD size** **Size1**

Resets Bass, Treble and Balance adjustments to factory default settings.

**Reset**

Increases or decreases the bass response.

**Bass** **0**

Increases or decreases the treble response.

**Treble** **0**

Emphasizes the left / right speaker volume.

**Balance** **0**

Equalizes overall volume levels across all channels and external inputs. **(On/Off)**

**AI sound** **On**

Enhances audio response when listening to stereo. **(On/Off)**

The Surround sound feature does not function when using headphones.

**Surround** **Off**

Enhances bass sound and provides powerful sound. **(On/Off)**

● This setting will not function if "off" is set in "Speaker output".

**Bass boost** **Off**

Minimizes volume disparity after switching to external inputs

**Audio leveler** **0**

Switch to "Off" when using external speakers **(On/Off)**

● "AI sound", "Surround", and "Audio leveler" do not work if "Off" is selected

**Speaker output** **On**

The default setting is "Digital" for HDMI connection. (Digital input signal)

Select audio input terminal when DVI cable is connected. (Analog audio input signal)

**(Digital/Component 1/Component 2/Video 1/Video 2)**

**HDMI1 in** **Digital**

**HDMI2 in** **Digital**

**HDMI3 in** **Digital**

The TV can automatically turn On/Off at the designated date and time (p. 36)

**Sleep** **60**

Locks the channels and programs (p. 30)

Displays SD card data (p. 18-19)

**SD card**

Displays subtitles (Closed Caption) (p. 34)

**CC**

● In AV mode, the Audio menu and Setup menu give fewer options.

# How to Use Menu Functions

Various menus allow you to make settings for the picture, sound, and other functions so that you can enjoy watching TV best suited for you.



## 1 Display menu



- Displays the functions that can be set (varies depending on the input signal)

## 2 Select "Setup"

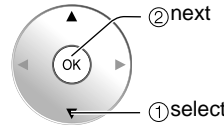
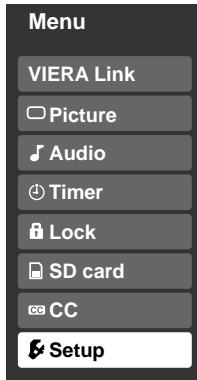

■ Press to exit from a menu screen



■ Press to return to the previous screen



## 3 Select the item

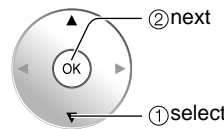
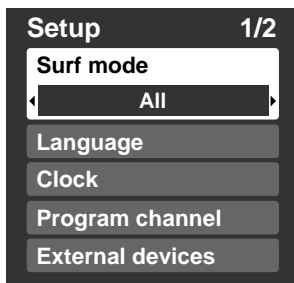

## 1 Display Sub Menu



## 2 Select the item

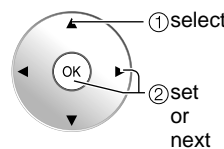
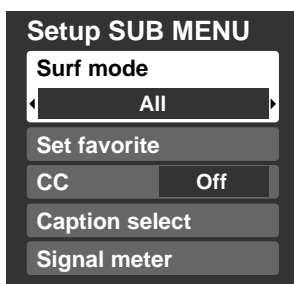

## Menu list

Menu	Item			
Setup	Surf mode			
	Language			
	Clock			
	Program channel			
	External devices	Input labels		
		VIERA Link setting	VIERA Link	
			Power off link	
			Power on link	
	Default speakers			
	Advanced setup	Auto power on		
No signal shut-off				
No action shut-off				
Power Save				
Play SD card automatically				
About				
Reset				

## Sub menu list

Menu	Item	
Setup SUB MENU	Surf mode	
	Set favorite	
	CC	
	Caption select	
	Signal meter	



# (Continued)

Adjustments/Configurations (alternatives)	
Sets the mode to select the channel with Channel up/down button <b>(All/Favorite/Digital Only/Analog only)</b> ● Favorite: Only channels registered as FAVORITE (p. 17)	Surf mode All
Selects the screen menu language (p. 13)	Language
Adjusts the clock (p. 13)	Clock
Sets channels (p. 32)	Program channel
Selects the terminal and label of the external equipment (p. 35)	
Controls equipment connected to HDMI terminals (p. 26) <b>(On/Off)</b> ● "Power off link", "Power on link", and "Default speakers" cannot be selected if "Off" is set.	VIERA Link On
Sets "Power off link" of HDMI connection equipment (p. 26) <b>(Set/No)</b>	Power off link Set
Sets "Power on link" of HDMI connection equipment (p. 26) <b>(Set/No)</b>	Power on link Set
Selects the default speakers (p. 26) <b>(TV/Theater)</b>	Default speakers TV
Turns TV On automatically when the cable box or a connected device is turned On <b>(No/Set)</b> ● The "Sleep" timer, "On / Off timer", and "First time setup" will not function if "Auto power on" is set. (p. 36)	Auto power on No
To conserve energy, the TV automatically turns off when NO SIGNAL and NO OPERATION is performed for more than 10 minutes. <b>(Set/No)</b> <b>Note</b> ● Not in use when setting "Auto power on", "On/Off Timer", "Lock", or Digital channel. ● "No signal shut-off was activated" will be displayed for about 10 seconds when the TV is turned on for the first time after turning the power off by "No signal shut-off". ● The on-screen display will flash 3, 2 and 1 to indicate the last three (3) remaining minutes prior to the shut-off.	No signal shut-off Set
To conserve energy, the TV automatically turns off when no operation of remote or side panel key continues for more than 3 hours. <b>(No/Set)</b> <b>Note</b> ● Not in use when setting "Auto power on" or "On/Off Timer". ● "No action shut-off was activated" will be displayed for about 10 seconds when the TV is turned on for the first time after turning the power off by "No action shut off". ● The on-screen display will flash 3, 2 and 1 to indicate the last three (3) remaining minutes prior to the shut-off.	No action shut-off No
Reduces screen brightness to lower power consumption. Eye-friendly for viewing in a dark room. <b>(Standard/Saving)</b>	Power Save Standard
Set "On" you to play back SD cards automatically. <b>(On/Off)</b>	Play SD card automatically On
Displays TV version and software license.	About
Performing Reset will clear all items set with Setup, such as channel settings. (p. 32)	Reset

Adjustments/Configurations (alternatives)	
Sets the mode to select the channel with Channel up/down button <b>(All/Favorite/Digital Only/Analog only)</b>	
Sets favorite channels. (p. 17)	
Displays Closed Caption. (p. 34) <b>(Off/On)</b>	
Changes the station identifier. (p. 33)	
Checks the signal strength if interference or freezing occurs on a digital image. (p. 33)	

# VIERA Link™ “HDAVI Control™”\*

\* Simultaneously control all Panasonic “HDAVI Control” equipped components using one button on one remote.

VIERA Link™ is a new name for EZ Sync™.

Enjoy additional HDMI Inter-Operability with Panasonic products which have “HDAVI Control” function.

This TV supports “HDAVI Control 3” function.

Connections to the equipment (DVD recorder DIGA, HD Camcorder, Player theatre, RAM theater, Amplifier, etc.) with HDMI cables allow you to interface them automatically.

The equipment with “HDAVI Control” function enables the following operations:

- Automatic Input Switching (p. 27)
- Power on link (p. 27)
- Power off link (p. 27)
- Default speakers (p. 27)
- One-touch theater playback (p. 27)
- Speaker control (p. 29)

The equipment with “HDAVI Control 2” (or more) function enables the following operations.

- VIERA Link control only with the TV’s remote control (for “HDAVI Control 2” or “HDAVI Control 3”) (p. 29)
- Providing the setting information (for “HDAVI Control 3”) (p. 27)
- Automatic lip-sync function (for “HDAVI Control 3”) (p. 27)
- Direct TV Recording (for “HDAVI Control 3”) (p. 29)

VIERA Link “HDAVI Control”, based on the control functions provided by HDMI which is an industry standard known as HDMI CEC (Consumer Electronics Control), is a unique function that we have developed and added. As such, its operation with other manufacturers’ equipment that supports HDMI CEC cannot be guaranteed.

Please refer to the individual manuals for other manufacturers’ equipment supporting the VIERA Link function.

■ **For the first time / When adding new equipment, reconnecting equipment or changing the setup after the connection, turn the equipment on and then switch the TV on. Select the input mode to HDMI1, HDMI2 or HDMI3 (p. 20), and make sure that an image is displayed correctly.**

## ■ HDMI cable

This function needs an HDMI compliant (fully wired) cable. Non-HDMI-compliant cables cannot be utilized.

It is recommended that you use Panasonic’s HDMI cable. Recommended part number:

RP-CDHG10 (3.3 ft/1.0 m) RP-CDHG15 (4.9 ft/1.5 m), RP-CDHG20 (6.6 ft/2.0 m), RP-CDHG30 (9.8 ft/3.0 m), RP-CDHG50 (16.4 ft/5.0 m)

\* For more detail on the external equipment’s connections, please refer to the operating manuals for the equipment.

**1 Follow direction ① - ⑤ in “VIERA Link setting” (p. 21)**

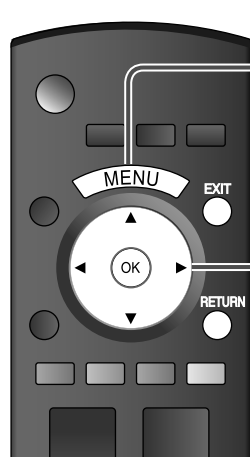

①

## 2 Select settings

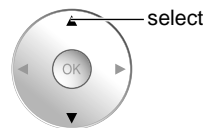
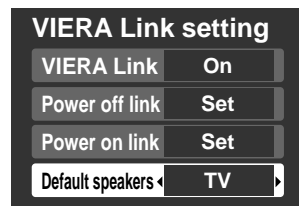

②

■ **Press to exit from a menu screen**



■ **Press to return to the previous screen**



③

## 3 Set

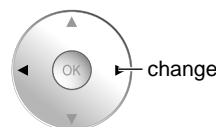
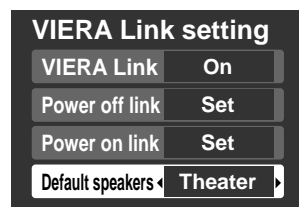

Automatic Input Switching

Power on link

Power off link

Default speakers

One-touch theater playback

Providing the setting information (for “HDAVI Control 3”)

Automatic lip-sync function (for “HDAVI Control 3”)

At the start of the DIGA, Player theater, or RAM theater playback, the TV’s input automatically switches to the input based on the playback equipment.

- For the RAM theater, the speakers automatically switch to the theater system.  
If using the DIGA operation, the TV’s input automatically switches to the DIGA and DIGA menu is displayed.

When “Set” is selected (p. 25), TV is turned on automatically and switches to the appropriate HDMI input whenever VIERA Link compatible equipment is initially turned on and Play mode is selected.

When “Set” is selected (p. 25) and the TV is turned off, all connected VIERA Link compatible equipment is also automatically turned off.

- DIGA (Panasonic DVD Recorder) will not turn off if it is still in rec mode.
- Caution:** The TV remains on even if the VIERA Link compatible equipment is turned off.

“TV” is the default setting. To set the Home Theater system as default speakers, change the default speakers setting from “TV” to “Theater”. Sound will be output from the Home Theater whenever the TV is powered on.

If the “ONE TOUCH PLAY” key is pressed on the remote control for Panasonic Home Theater system, the following sequence of operations is performed automatically.

- ① Home Theater power switches On, and playback begins.
- ② TV power switches On, and the playback screen is displayed.
- ③ Audio is muted on the TV and switches to the theater system.

The following information about the TV settings can be transmitted to each equipment (Recorder/Home theater/ Player) that has “HDAVI Control 3” function connected to a TV with HDMI cable.

Transmittable data		Recorder	Home theater	Player
①	On Screen Display Language setting (English/Español/Français)	○	○	○
②	Panel Aspect Ratio (16:9 fixed)	○	○	○
③	Closed caption information			
	Mode	○	---	---
	CC type	○	---	---
	Digital setting	○	---	---
④	Channel information			
	Input signal	○	---	---
	Channel list	○	---	---
	Caption information	○	---	---

**Note**

- There is a possibility that all the GUI language information might be set from equipment that has HDMI CEC function connected to TV with HDMI cable. Depending on operating conditions or the specification for each piece of equipment the setting may or may not be applied.
- For the detail on external equipment’s operation, please refer to the operating manuals for the equipment.

**[For Recorder]**

- You cannot operate other functions while transmitting TV’s information above except Power On/Off key operation. When you turn off this unit, the transmission will be interrupted (only when you are transmitting ④ Channel information).

Minimizes lip-sync delays between the picture and audio when you connect to a Panasonic theater system or Amplifier.

# VIERA Link™ “HDAVI Control™”\*

You can enjoy more convenient operation with the “HDAVI Control” function in the “VIERA Link” menu.

For more details on the “HDAVI Control” function, refer to p. 26

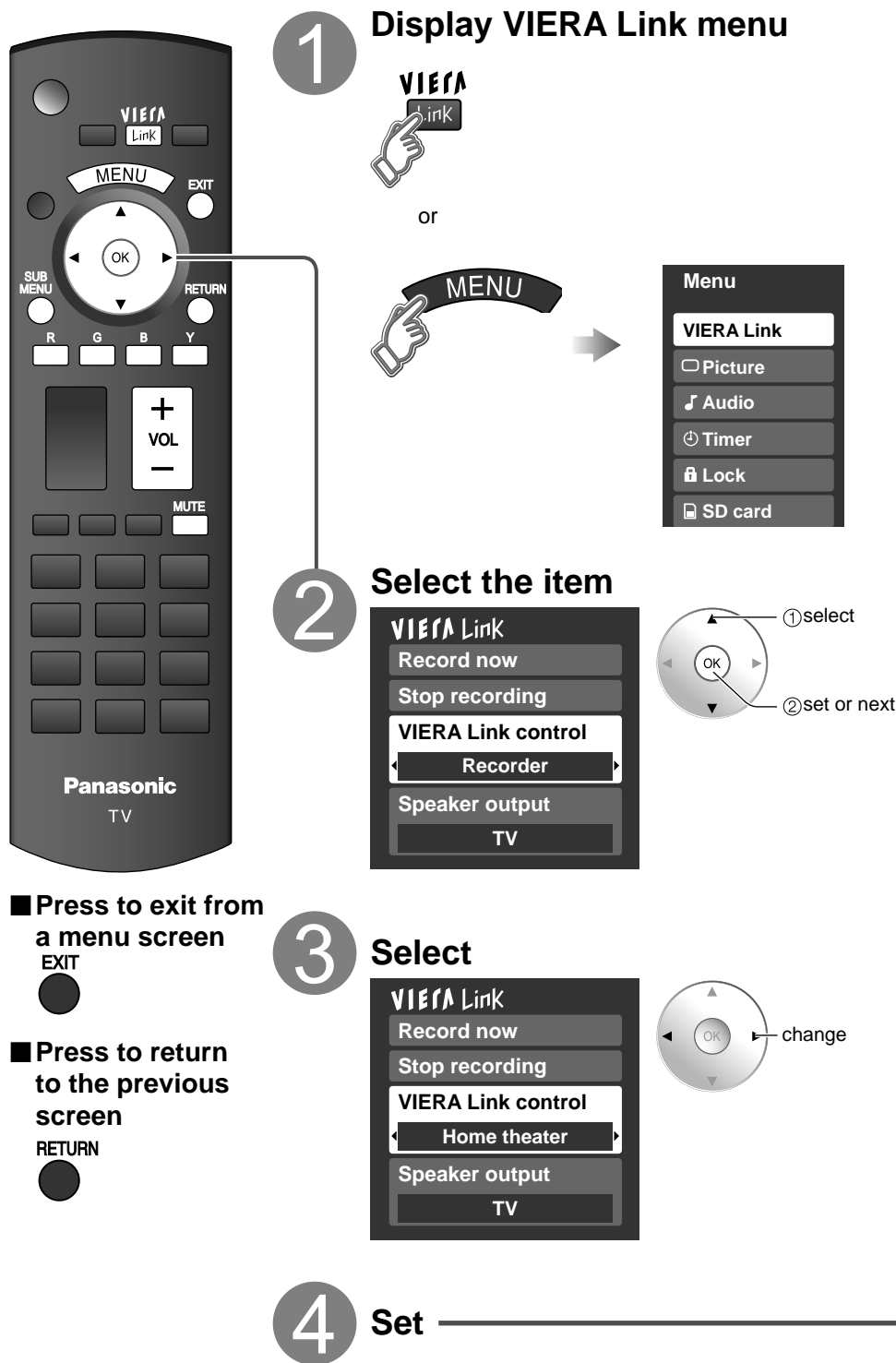

■ Press to exit from a menu screen



■ Press to return to the previous screen



Speaker control

VIERA Link Control only with the TV's remote control (for “HDAVI Control 2” or “HDAVI Control 3”)

Direct TV Recording (for “HDAVI Control 3”)

# (Continued)

You can select Home theater or TV speakers for audio output.  
Control theater speakers with the TV's remote control.  
This function is available only when Panasonic Amplifier or Player theater is connected.

- ① Select "Speaker output"
- ② Select "Home theater" or "TV"

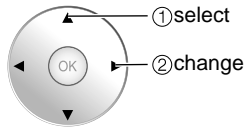

■ **Home theater:** Adjustment for equipment



- The sound of the TV is muted.
- When the equipment is turned off, the TV speakers take over.
- Selecting "Home theater" turns the equipment on automatically if it is in standby mode.

■ **TV:** The TV speakers are on.

In the VIERA Link menu, you can select HDMI connected equipment and access it quickly. Continue using your TV's remote control to operate the equipment, pointing it at the TV.

- ① Select "VIERA Link Control"
- ② Select the equipment you want to access.  
(Recorder/Home theater/Player/Camcorder)

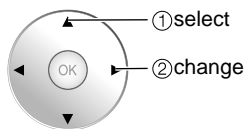

You can select available items only.

■ **Available TV's remote control buttons**

	Move the cursor/Select
	Set/Access
	Return to the previous menu
	Display the Functions menu on the equipment
	Available when the purpose of the keys is displayed on screen

- ③ Operate the equipment with the TV's remote control, pointing it at the TV.

- To operate the equipment, read the manual of the equipment.

Records the current program on the recorder immediately.

- ① Select "Record now"
- ② Select "Stop recording", when you want to stop recording

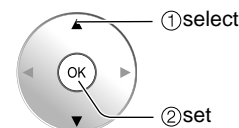
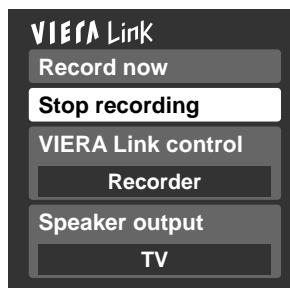
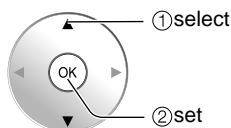

- For optimal recording, the settings of the recorder might be required. For details, read the manual of the recorder.

- Recording will not stop automatically when the program is finished.

# Lock

You can lock specified channels or shows to prevent children from watching objectionable content.

## 1 Display menu

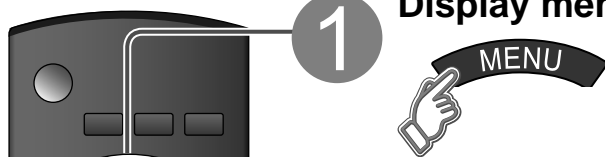

1

## 2 Select "Lock"

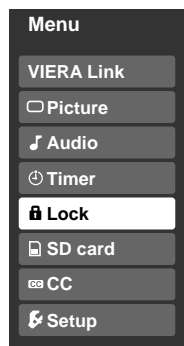

2

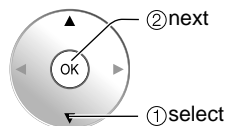

You will be asked to enter your password each time you display the Lock menu.

## 3 Input your 4-digit password

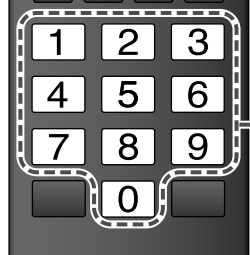

3

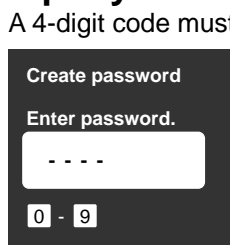

A 4-digit code must be entered to view a blocked program or change rating settings.

- If it is your first time entering the password, enter the password twice in order to register it.

### Press to exit from a menu screen



4

## 4 Select the Lock mode

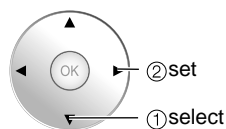
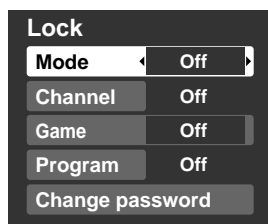

Off: Unlocks all the lock settings of "Channel", "Game" and "Program".

All: Locks all the inputs regardless of the lock settings of "Channel", "Game" and "Program".

Custom: Locks specified inputs of "Channel", "Game" and "Program".

### Caution

- Make a note of your password in case you forget it. (If you have forgotten your password, consult your local dealer.)

### Note

- When you select a locked channel, a message will be displayed that allows you to view the channel if you input your password.

5

## 5 Select the item

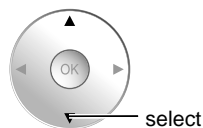
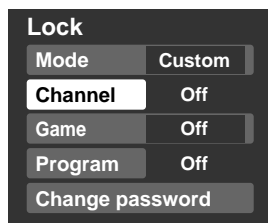

- "Channel", "Game" and "Program" will grey out unless "Custom" is selected in "Mode".

6

## 6 Set

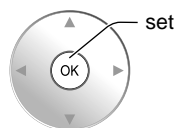

■ To select the channel or the rating of the program to be locked

**Channel lock**

Select up to 7 (1-7) channels to be blocked. These channels will be blocked regardless of the program rating.

- ① Select "Mode" and set to "Custom"
- ② Select channel to lock.

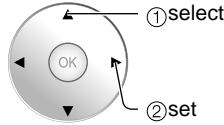
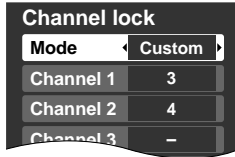

- To lock/unlock all channels: Select "Mode" and set to "All" or "Off".

All: Locks all channels  
Off: Unlocks all channels

**Game lock**

Locks Channel 3, Channel 4 and external inputs.

- ⑤ Select "Game" in ⑤ and set to "On".

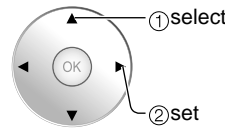

On: Locks  
Off: Unlocks

**Program lock**

■ To set a rating level

"V-chip" technology enables restricted shows to be locked according to TV ratings.

- ① Select "Mode" and set to "On".

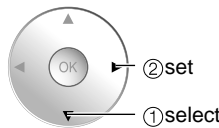
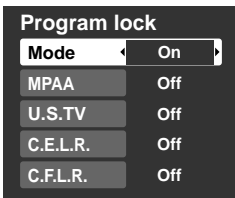

- ③ Select the rating to be locked

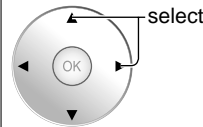

Example of "MPAA" (U.S movie ratings)

NR	No rating
G	General Audience: All ages admitted
PG	Parental Guidance Suggested
PG-13	Parents Strongly Cautioned: Inappropriate for children under 13
R	Restricted: Under 17 requires accompanying parent or adult guardian
NC-17	No one 17 and under admitted
X	Adults only

- ② Select the rating category you wish to follow

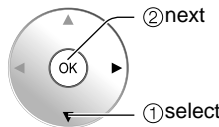
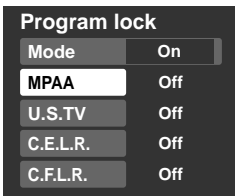

- To get more information (p. 39)

MPAA: U.S movie ratings  
U.S.TV: U.S TV program ratings  
C.E.L.R.: Canadian English ratings  
C.F.L.R.: Canadian French ratings

**Change password**

■ To change the password

- ① In ④, select "Change password" and press OK
- ② Input the new 4-digit password twice

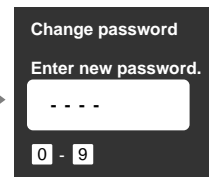
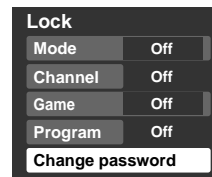

**Note**

- This television is designed to support the "Downloadable U.S. Region Rating System" when available. (Available only in U.S.A.)
- The Off rating is independent of other ratings.
- When placing a lock on a specific-age-based-rating level, the Off rating and any other more restrictive ratings will also be blocked.

# Editing and Setting Channels

The current channel settings can be changed according to your needs and reception conditions.

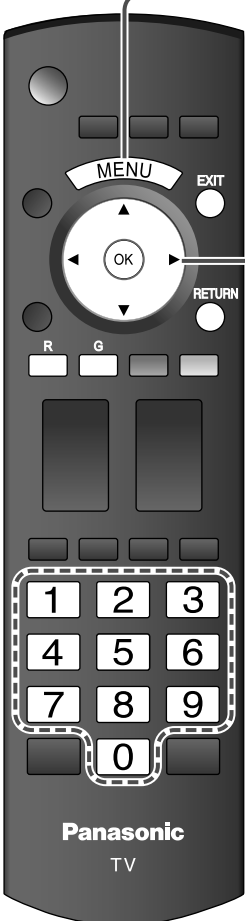

**1 Display menu**

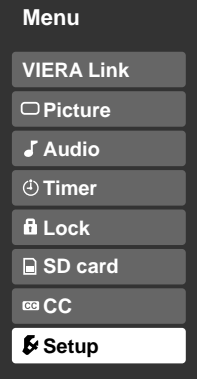
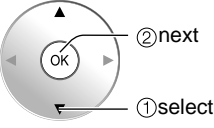

**2 Select "Setup"**

**3 Select "Program channel"**



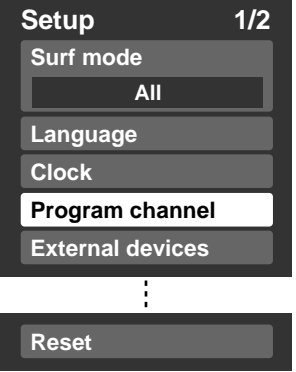
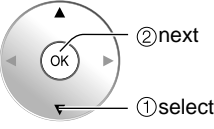

**4 Select the function**

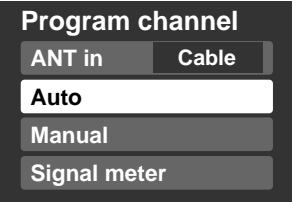
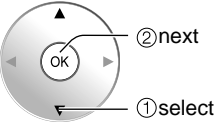
**5 Set**

■ Press to exit from a menu screen  
EXIT



■ To reset the settings of setup menu

- ① Select "Reset" in Setup menu (3) and press OK
- ② Input your 4-digit password with number buttons
- ③ Select "YES" on the confirmation screen and press OK

**Auto**  
Set automatically

**Manual**  
Set manually

**Signal meter**  
Check signal strength



Automatically searches and adds available channels to the memory.

- ① **Select “ANT in”**  
 → Select Cable or Antenna (p. 14)

- ② **Select “Auto”**

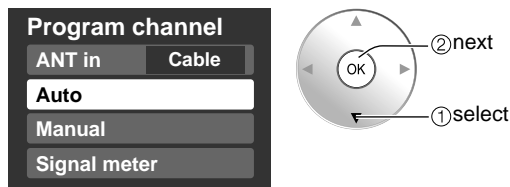

- ③ **Select a scanning mode** (p. 14)

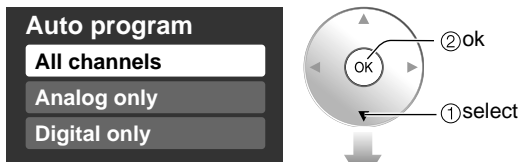

Settings are made automatically

- After the scanning is completed, select “Apply”.
- (see below ⑤).
- All previously saved channels are erased.

Use this procedure when changing the channel setup or changing the channel display.

Also, use this to add or skip channels from the channel list manually.

You can select a channel tuning mode (Digital only/ Analog only) in “Surf mode”(p. 25)

- ① **Select “Edit”**



- ② **Select the item to be edited**

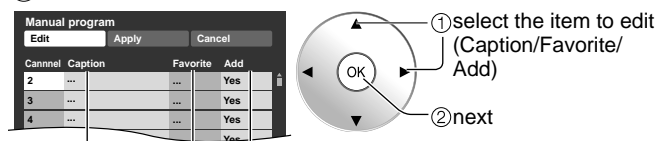

<p><b>Manual program</b></p> <p>Edit    Apply    Cancel</p> <table border="1"> <thead> <tr> <th>Channel</th> <th>Caption</th> <th>Favorite</th> <th>Add</th> </tr> </thead> <tbody> <tr><td>2</td><td>---</td><td>---</td><td>Yes</td></tr> <tr><td>3</td><td>---</td><td>---</td><td>Yes</td></tr> <tr><td>4</td><td>---</td><td>---</td><td>Yes</td></tr> <tr><td>5</td><td>---</td><td>---</td><td>Yes</td></tr> </tbody> </table> <p>Favorite    Add</p>	Channel	Caption	Favorite	Add	2	---	---	Yes	3	---	---	Yes	4	---	---	Yes	5	---	---	Yes	<ul style="list-style-type: none"> <li>● <b>Caption:</b> Changes the station identifier</li> <li>● <b>Favorite:</b> Registers channel to Favorite List</li> <li>● <b>Add:</b> Adds or skips channels</li> </ul>
Channel	Caption	Favorite	Add																		
2	---	---	Yes																		
3	---	---	Yes																		
4	---	---	Yes																		
5	---	---	Yes																		

- ③ **Edit**

- **Caption**

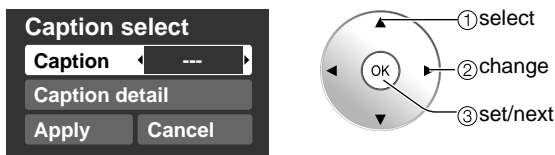

**Caption**  
Select the station identifier

**Caption detail**  
Rename (maximum 7 characters available)

- **Favorite**



**Set favorite** Select the number

- **Add**

Press OK to select “Yes (add)” or “No (skip)” → RETURN

- ④ **Move cursor to channel number**



- ⑤ **Select “Apply”**

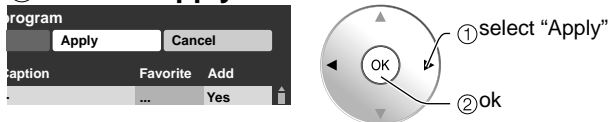

**To cancel the Edit**

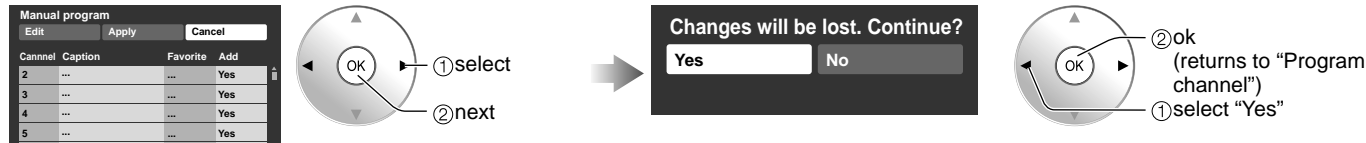

Check the signal strength if an interference is found or freezing occurs on a digital image.

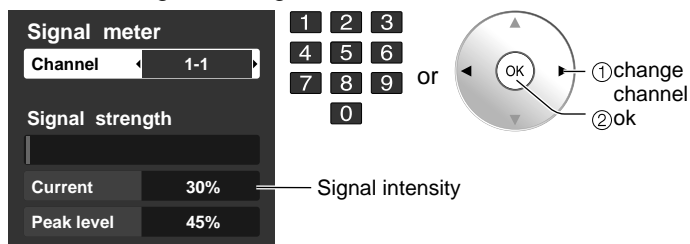

- If the signal is weak, check the antenna.
- If no problem is found, consult your local dealer.

**Note**

- Not available if “Cable” is selected in “ANT in” (see above).
- Available only for digital antenna channels.

● If “Lock” (p. 30) is activated and “Program channel” is selected, “Enter password.” will be displayed.

# Closed Caption

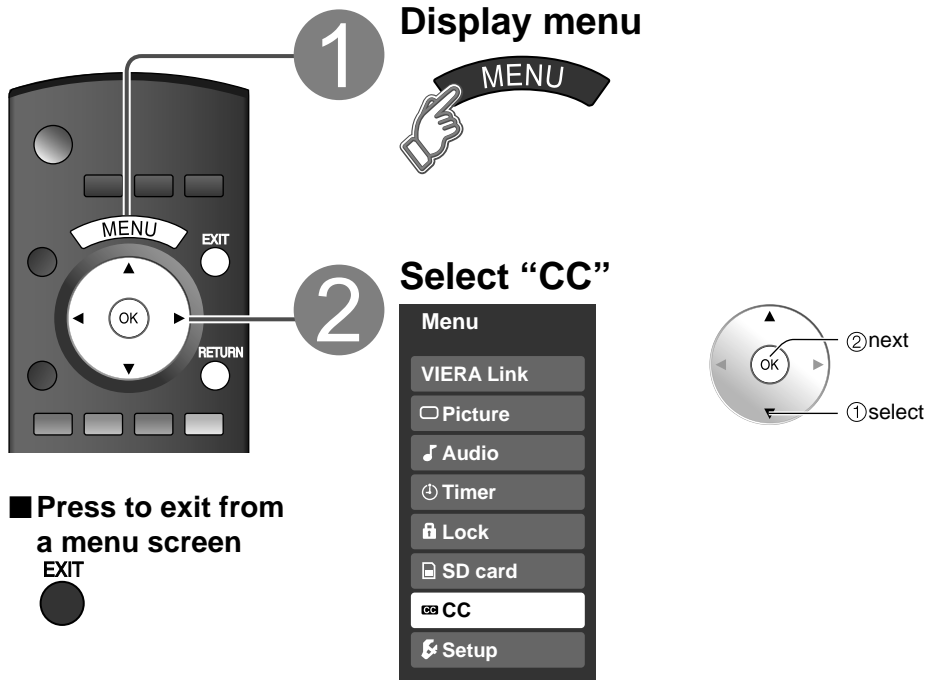

The television includes a built-in decoder that is capable of providing a text display of the audio. The program being viewed must be transmitting Closed Caption (CC) information. (p. 40)

## Select the item and set

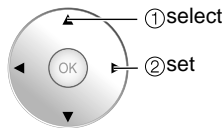
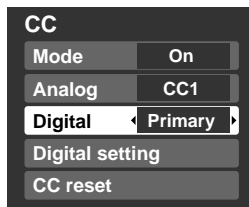

- The settings in "Analog" or "Digital" depend on the broadcaster.

**Mode** Select "On" (when not using, select "Off").

**Analog** (Choose the Closed Caption service of Analog broadcasting.)

CC1-4: Information related to pictures (Appears at bottom of screen)

T1-4: Textual information (Appears over entire screen)

**Digital** (The Digital Closed Caption menu lets you configure the way you choose to view the digital captioning.)

Select the setting.

- "Primary", "Second.", "Service 3", "Service 4", "Service 5", "Service 6"

## To make more in-depth display settings in digital programs

- Select "Digital setting" and press OK
- Select the item and set

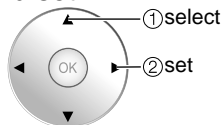
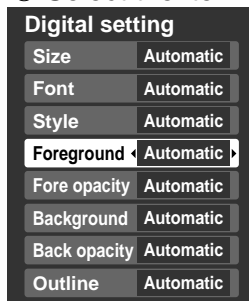

- Size: Text size
- Font: Text font
- Style: Text style (Raised, Depressed, etc.)
- Foreground: Color of text
- Fore opacity: Opacity of text
- Background: Color of text box
- Back opacity: Opacity of text box
- Outline: Outline color of text (Identify the setting options on the screen.)

## To reset the settings

Select "CC reset" and press OK

**CC**  
Display  
Closed  
Caption

# Input Labels

**1 Display menu**



**2 Select "Setup"**

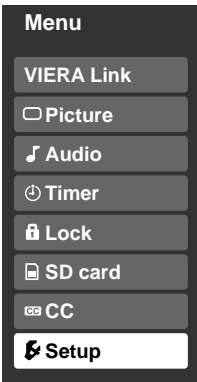
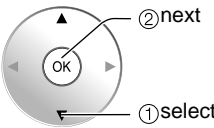



■ Press to exit from a menu screen

EXIT

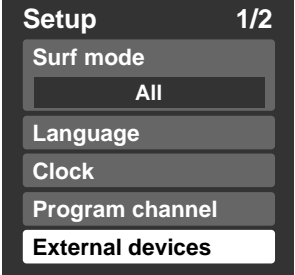
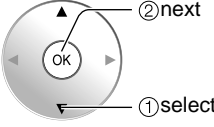

**3 Select "External devices"**

**4 Select "Input labels"**

## Input labels

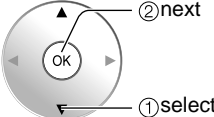
### Display labels of external devices

Devices connected to external input terminals can be labeled for easier identification during input selection. (In selecting input mode from p. 20 ②)

#### ■ Select the terminal and label of the external equipment

Input labels	
Component 1	▼
Component 2	
HDMI 1	
HDMI 2	
HDMI 3	GAME
Video 1	
Video 2	GAME

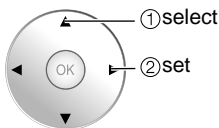

[example]

- Terminals: Comp. 1-2/HDMI 1-3/Video 1-2
- Label: SKIP\*/VCR/DVD/CABLE/DBS/PVR/GAME/AUX/RECEIVER/[BLANK]
- \* If "SKIP" is selected, the TV/VIDEO button press will skip its input.
- Each selected labels will be displayed on "Input select" screen. (P. 20)

# Using Timer

The TV can automatically turn On/Off at the designated date and time.

- The Clock must be set before On time/Off time settings. (p. 13)
- The "Sleep" timer and "On / Off timer" will not work if the "Auto power on" (p. 25) is set.



## 1 Display menu



## 2 Select "Timer"

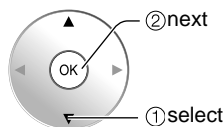
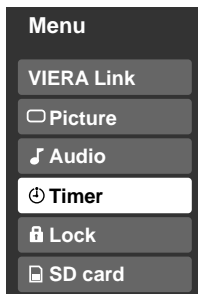

## 3 Select the timer to set

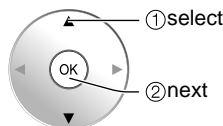

- Sleep** Turns Off automatically
- Timer 1** Turns On/Off automatically (5 timers can be set.)
- Timer 5**

■ Press to exit from a menu screen

EXIT



■ Press to return to the previous screen

RETURN



## 4 Set the timer

### ■ To set "Sleep" (Off Timer)

Set to shut the unit off after a pre-selected amount of time.

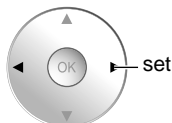

- 0/30/60/90 (minutes)

### ■ To set "Timer 1-5" (On/Off Timer)

Select the item and set

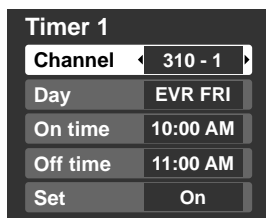

or

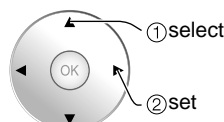

**Channel** Select the channel

**Day** Select the day

SUN/MON/TUE/WED/THU/FRI/SAT  
(displays the nearest future date)  
MON-FRI/SAT-SUN/DAILY/EVR SUN/EVR MON/  
EVR TUE/EVR WED/EVR THU/EVR FRI/ EVR SAT

**On time** The time to turn On

**Off time** The time to turn Off

**Set** Timer setting (On/Off)

### Note

- The TV automatically turns Off after 90 minutes when turned On by the Timer. This operation will be cancelled if the Off time is selected or if a key is pressed.

# Recommended AV Connections

These diagrams show our recommendations on how to connect the TV unit to your various equipment. For other connections, consult the instructions for each piece of equipment and its specifications. For additional assistance, please visit our website at: [www.panasonic.com](http://www.panasonic.com) [www.panasonic.ca](http://www.panasonic.ca)

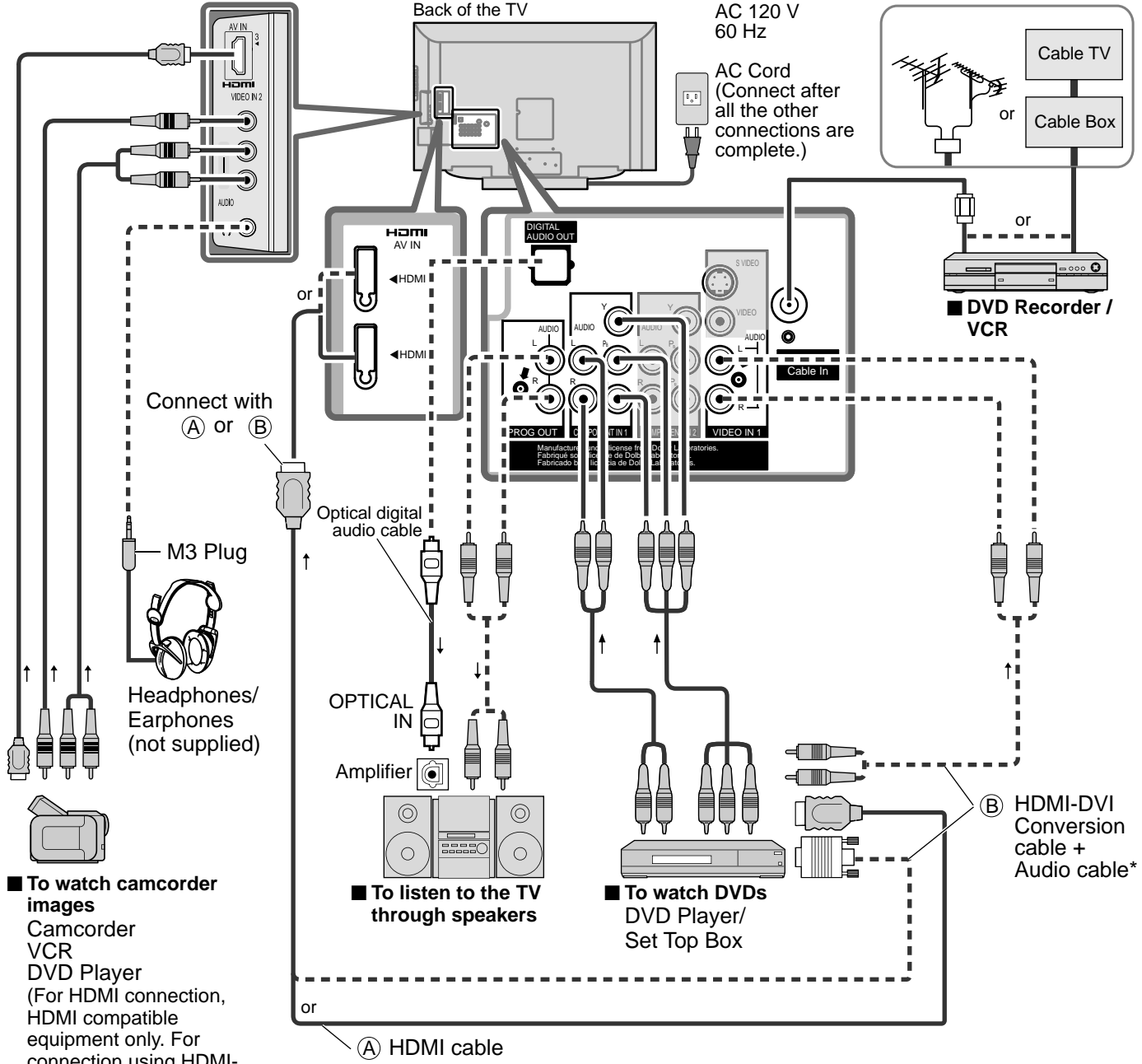

**To watch camcorder images**  
 Camcorder  
 VCR  
 DVD Player  
 (For HDMI connection, HDMI compatible equipment only. For connection using HDMI-DVI Conversion cable, see HDMI 1 or HDMI 2 connection on this page.)

**To listen to the TV through speakers**

**To watch DVDs**  
 DVD Player/  
 Set Top Box

Recommended AV Connections  
 Using Timer

Advanced

\* Please see p. 22-23 for setup when using an external analog audio cable with an HDMI to DVI cable.

## VIERA Link™ Connections

Follow the connection diagrams below for HDAVI control of a single piece of AV equipment such as a DVD recorder (DIGA), RAM theater, or Player theater system. Refer to page 26-29 for Setup Menu settings and additional control information.

- Optional HDMI and/or optical cables are not included.

If connection (or setting) of equipment compatible with HDAVI control is changed, switch the power of this unit Off and On again while the power of all equipment is On (so that the unit can correctly recognize the connected equipment) and check that DVD recorder (DIGA), RAM theater, and Player theater playback operate.

### Note

- HDMI 1 is recommended. When connecting to HDMI 2 / HDMI 3, set the input mode to HDMI 2 / HDMI 3 (p. 20) initially before connecting to HDMI 2 / HDMI 3. After connection, confirm the HDMI control functions (p. 26-29).

### ■ Connecting this unit to the DVD recorder (DIGA), RAM theater, or Player theater

- For DVD recorder (DIGA) : Connect with HDMI cable
- For RAM theater and Player theater: Connect with the HDMI and audio cables. If audio cable is not connected, you cannot listen to the TV program through the theater system.

### ■ Connecting this unit to a DVD recorder (DIGA) and AV amp

When using an "VIERA Link" audio-video amplifier and a compatible DVD recorder (DIGA) recorder, use a daisy chain connection as shown below.

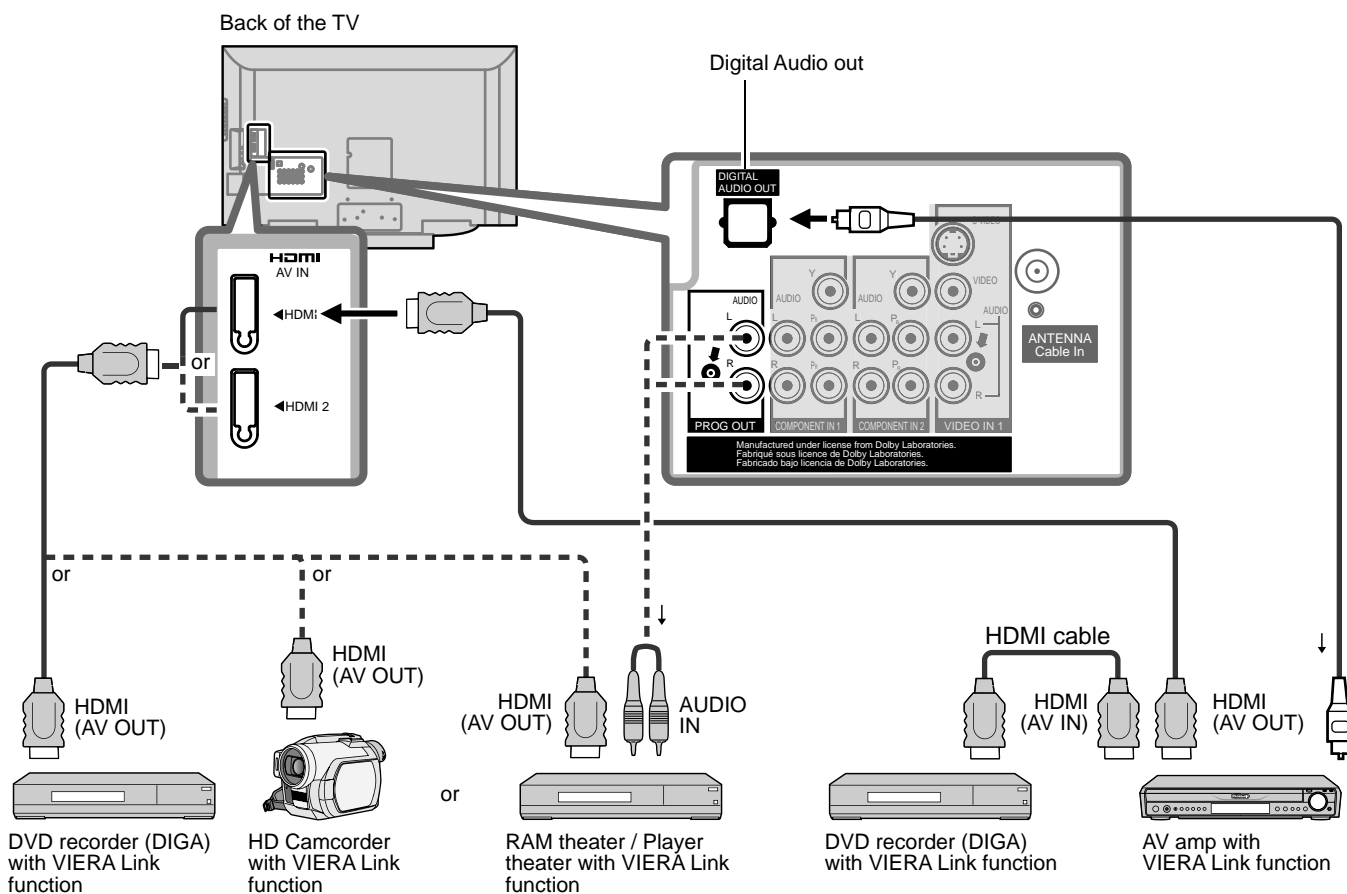

- One AV amp and one DVD recorder (DIGA), can be operated with this unit.
- Be sure to connect the AV amp between this unit and the DVD recorder (DIGA).

### ■ Setting of this unit after connection

After making connections as shown above, set "VIERA Link" (under "VIERA Link setting") to "On" using the Setup menu. (p. 21, 24-25).

### Note

- Individual HDMI equipment may require additional menu settings specific to each model. Please refer to their respective operating instruction manuals.
- When audio from other equipment connected to this unit via HDMI is output using "DIGITAL AUDIO OUT" of this unit, the system switches to 2CH audio. (When connecting to an AV amp via HDMI, you can enjoy higher sound quality.)
- About HDMI cable for connecting Panasonic HD camcorder, read the manual of the equipment.

# Ratings List for Lock

“V-chip” technology enables you to lock channels or shows according to standard ratings set by the entertainment industry. (p. 31)

## ■ U.S. MOVIE RATINGS (MPAA)

NR	NO RATING (NOT RATED) AND NA (NOT APPLICABLE) PROGRAMS. Movie which has not been rated or where rating does not apply.
G	GENERAL AUDIENCES. All ages admitted.
PG	PARENTAL GUIDANCE SUGGESTED. Some material may not be suitable for children.
PG-13	PARENTS STRONGLY CAUTIONED. Some material may be inappropriate for children under 13.
R	RESTRICTED. Under 17 requires accompanying parent or adult guardian.
NC-17	NO ONE 17 AND UNDER ADMITTED.
X	ADULTS ONLY.

## ■ U.S. TV PROGRAMS RATINGS (U. S. TV)

Age-based Group	Age-based Ratings	Possible Content Selections	Description
NR (Not Rated)	TV-NR	<ul style="list-style-type: none"> <li>● Viewable</li> <li>● Blocked</li> </ul>	Not Rated.
Youth	TV-Y	<ul style="list-style-type: none"> <li>● Viewable</li> <li>● Blocked</li> </ul>	All children. The themes and elements in this program are specifically designed for a very young audience, including children from ages 2-6.
	TV-Y7	<ul style="list-style-type: none"> <li>● FV Blocked</li> <li>● Viewable</li> <li>● Blocked</li> </ul>	Directed to older children. Themes and elements in this program may include mild physical or comedic violence, or may frighten children under the age of 7.
Guidance	TV-G	<ul style="list-style-type: none"> <li>● Viewable</li> <li>● Blocked</li> </ul>	General audience. It contains little or no violence, no strong language, and little or no sexual dialogue or situations.
	TV-PG	<ul style="list-style-type: none"> <li>● D,L,S,V (all selected)</li> <li>● Any combination of D, L, S, V</li> </ul>	Parental guidance suggested. The program may contain infrequent coarse language, limited violence, some suggestive sexual dialogue and situations.
	TV-14	<ul style="list-style-type: none"> <li>● D,L,S,V (all selected)</li> <li>● Any combination of D, L, S, V</li> </ul>	Parents strongly cautioned. This program may contain sophisticated themes, sexual content, strong language and more intense violence.
	TV-MA	<ul style="list-style-type: none"> <li>● L,S,V (all selected)</li> <li>● Any combination of L, S, V</li> </ul>	Mature audiences only. This program may contain mature themes, profane language, graphic violence, and explicit sexual content.

FV: Fantasy/Cartoon Violence. V: Violence S: Sex L: Offensive Language D: Dialogue with sexual content.

## ■ CANADIAN ENGLISH RATINGS (C. E. L. R.)

E	Exempt - Exempt programming includes: news, sports, documentaries and other information programming, talk shows, music videos, and variety programming.
C	Programming intended for children under age 8. No offensive language, nudity or sexual content.
C8+	Programming generally considered acceptable for children 8 years and over. No profanity, nudity or sexual content.
G	General programming, suitable for all audiences.
PG	Parental Guidance suggested. Some material may not be suitable for children.
14+	Programming contains themes or content which may not be suitable for viewers under the age of 14. Parents are strongly cautioned to exercise discretion in permitting viewing by pre-teens and early teens.
18+	18+ years old. Programming restricted to adults. Contains constant violence or scenes of extreme violence.

## ■ CANADIAN FRENCH RATINGS (C. F. L. R.)

E	Exempt - Exempt programming.
G	General - Programming intended for audience of all ages. Contains no violence, or the violence content is minimal or is depicted appropriately.
8 ans+	8+ General - Not recommended for young children. Programming intended for a broad audience but contains light or occasional violence. Adult supervision recommended.
13 ans+	Programming may not be suitable for children under the age of 13 - Contains either a few violent scenes or one or more sufficiently violent scenes to affect them. Adult supervision strongly suggested.
16 ans+	Programming may not be suitable for children under the age of 16 - Contains frequent scenes of violence or intense violence.
18 ans+	Programming restricted to adults. Contains constant violence or scenes of extreme violence.

### Caution

- The V-Chip system that is used in this set is capable of blocking “NR” programs (non rated, not applicable and none) as per FCC Rules Section 15.120(e)(2). If the option of blocking “NR” programs is chosen “unexpected and possibly confusing results may occur, and you may not receive emergency bulletins or any of the following types of programming:”
  - Emergency Bulletins (Such as EAS messages, weather warnings and others)
  - Locally originated programming • News • Political • Public Service Announcements • Religious • Sports • Weather

# Technical Information

## Closed Caption (CC)

- For viewing the CC of digital broadcasting, set the aspect to FULL (If viewing with H-FILL, JUST, ZOOM, or 4:3; characters might be cut off).
- The CC can be displayed on the TV if the receiver (such as a set-top box or satellite receiver) has the CC set On using the Component or HDMI connection to the TV.
- If the CC is set to On both the receiver and TV when the signal is 480i (except for the HDMI connection), the CC may overlap on the TV.
- If a digital program is being output in analog format, the CC data will also be output in analog format.
- If the recorder or output monitor is connected to the TV, the CC needs to be set up on the recorder or output monitor.

## Aspect Ratio

Lets you choose the aspect depending on the format of the received signal and your preference. (p. 16)  
(e.g.: in case of 4:3 image)

### ● FULL

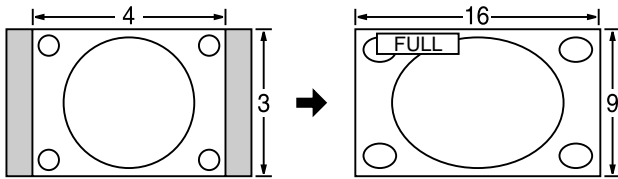

Enlarges the 4:3 image horizontally to the screen's side edges.  
(Recommended for anamorphic picture)

### ● JUST

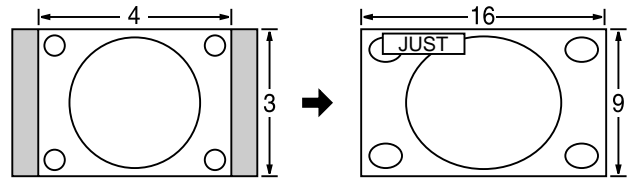

Stretches to justify the 4:3 image to the four corners of the screen.  
(Recommended for normal TV broadcast)

### ● H-FILL

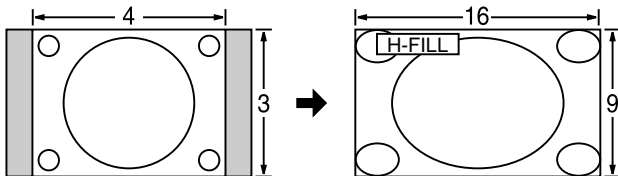

Enlarges the 4:3 image horizontally to the screen's side edges.  
The side edges of the image are cut off.

### ● 4:3

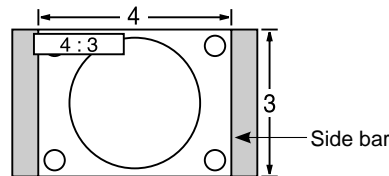

Standard

### ● ZOOM

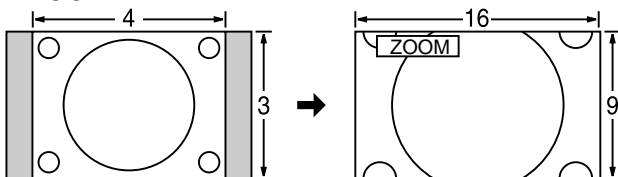

Enlarges the 4:3 image to the entire screen.  
(Recommended for Letter Box)

### Note

- 480i (4:3), 480i (16:9), 480p (4:3), 480p (16:9):  
FULL, JUST, 4:3 or ZOOM
- 1080p / 1080i / 720p:  
FULL, H-FILL, JUST, 4:3 or ZOOM

### ● Zoom adjust

Vertical image position and size can be adjusted in "ZOOM".

① Select "Zoom adjust" on the "Picture" menu. (p. 22-23)

② V-position: Vertical position adjustment

③ V-size: Vertical size adjustment

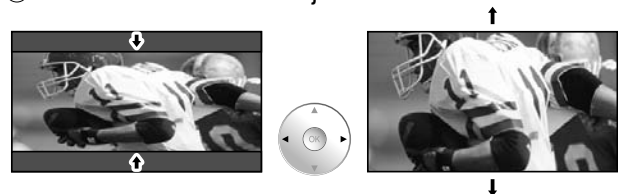

● To reset the aspect ratio →  (OK)



## Data format for SD Card browsing

Photo:	Still images recorded with digital still cameras compatible with JPEG files of DCF* and EXIF** standards
Data format:	Baseline JPEG (Sub-sampling: 4:4:4, 4:2:2 or 4:2:0)
Max. number of files:	9,999
Image resolution:	160 x 120 to 10,000,000

\* DCF (Design rule for camera file system): A Japan Electronics and Information Technology Industries Association's standard  
 \*\* EXIF (Exchangeable Image File Format)

### Caution

- A JPEG image modified with a PC may not be displayed.
- Partly degraded files might be displayed at a reduced resolution.

### Note

- Folder structure viewed in PC

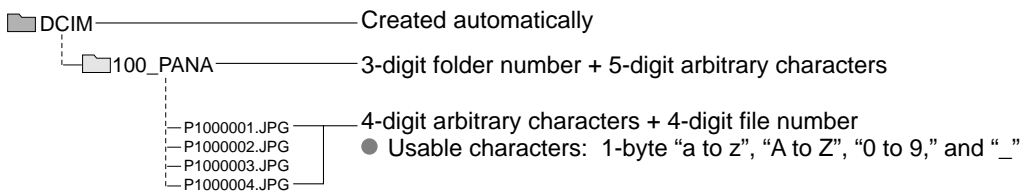

- The folder and file names may be different depending on the digital camera used.
- For the suitable SD Memory Cards, please confirm the latest information on the following website.  
<http://panasonic.co.jp/pavc/global/cs> (This site is in English only)

## Cautions in handling SD Card:

- Do not remove the card while the unit is accessing data (this can damage card or unit).
- Do not touch the terminals on the back of the card.
- Do not subject the card to a high pressure or impact.
- Insert the card in the correct direction (otherwise, card may be damaged).
- Electrical interference, static electricity, or erroneous operation may damage the data or card.
- Back up the recorded data at regular intervals in case of deteriorated or damaged data or erratic operation of the unit. (Panasonic is not liable for any deterioration or damage of recorded data.)

## SD Card warning messages

Message	Meaning
Is SD card in?	<ul style="list-style-type: none"> <li>● The card is not inserted.</li> </ul>
No file	<ul style="list-style-type: none"> <li>● The card has no data or this type of data is not supported.</li> </ul>
Cannot read file	<ul style="list-style-type: none"> <li>● The file is broken or unreadable.</li> <li>● The TV does not support the format.</li> </ul>

## GalleryPlayer warning messages

Cannot display image due to incorrect ID data.	<ul style="list-style-type: none"> <li>● There is a problem with your TV decoder.</li> <li>● If this message appears, please contact Panasonic Service Center for assistance. Refer to page 48 (Customer Services Directory), page 47, 49 (Limited Warranty)</li> </ul>
Cannot display image on SD card.	<ul style="list-style-type: none"> <li>● There is a problem with the data. Check the data inside the SD card.</li> </ul>

## Viewing from a GalleryPlayer SD Card

You can view high-definition art and photography purchased on or downloaded to an SD card. GalleryPlayer provides pre-loaded SD cards with copy-protected imagery and images for download to your computer that can be saved on an SD card for display on your television.

GalleryPlayer images are available for a fee from GalleryPlayer, Inc.

# Technical Information (Continued)

## VIERA Link™ “HDAVI Control™”

HDMI connections to some Panasonic equipment allow you to interface automatically. (p. 26)

- This function may not work normally depending on the equipment condition.
- The equipment can be operated by other remote controls with this function on even if TV is in Standby mode.
- Image or sound may not be available for the first few seconds when the playback starts.
- Image or sound may not be available for the first few seconds when Input mode is switched.
- Volume function will be displayed when adjusting the volume of the equipment.
- If you connect the same kind of equipment at once (for example: one DIGA to HDMI 1 / another DIGA to HDMI 2), VIERA Link™ is available for the terminal with the smaller number.
- If you connect equipment that has “HDAVI Control 2” (or more) function to the TV with HDMI cable, the sound from DIGITAL AUDIO OUT terminal can be output as multi channel surround.
- “HDAVI Control 3” is the newest standard (current as of December, 2007) for the HDAVI Control compatible equipment. This standard is compatible with the conventional HDAVI equipment.

## HDMI connection

HDMI (high-definition multimedia interface) allows you to enjoy high-definition digital images and high-quality sound by connecting the TV unit and the devices.

HDMI-compatible equipment (\*1) with an HDMI or DVI output terminal, such as a set-top box or a DVD player, can be connected to the HDMI connector using an HDMI compliant (fully wired) cable.

- HDMI is the world's first complete digital consumer AV interface complying with a non-compression standard.
- If the external equipment has only a DVI output, connect to the HDMI terminal via a DVI to HDMI adapter cable (\*2).
- When the DVI to HDMI adapter cable is used, connect the audio cable to the audio input terminal.
- Audio settings can be made on the “HDMI 1 in”, “HDMI 2 in” or “HDMI 3 in” menu screen. (p. 22)  
Applicable audio signal sampling frequencies (L.PCM): 48 kHz, 44.1 kHz, 32 kHz

(\*1): The HDMI logo is displayed on an HDMI-compliant device.  
(\*2): Enquire at your local digital equipment retailer shop.

### Caution

- Use with a PC is not assumed.
- All signals are reformatted before being displayed on the screen.
- If the connected device has an aspect adjustment function, set the aspect ratio to “16:9”.
- These HDMI connectors are “type A”.
- These HDMI connectors are compatible with HDCP (High-Bandwidth Digital Content Protection) copyright protection.
- A device having no digital output terminal may be connected to the input terminal of either “COMPONENT”, “S VIDEO”, or “VIDEO” to receive analog signals.
- The HDMI input terminal can be used with only the following image signals: 480i, 480p, 720p, 1080i and 1080p. Match the output setting of the digital device.
- For details of the applicable HDMI signals, see below.

## Input signals that can be displayed

\* Mark: Applicable input signal for Component (Y, Pb, Pr) and HDMI

	horizontal frequency (kHz)	vertical frequency (Hz)	COMPONENT	HDMI
525 (480) / 60i	15.73	59.94	*	*
525 (480) / 60p	31.47	59.94	*	*
750 (720) / 60p	45.00	59.94	*	*
1,125 (1,080) / 60i	33.75	59.94	*	*
1,125 (1,080) / 60p	67.43	59.94		*
1,125 (1,080) / 60p	67.50	60.00		*
1,125 (1,080) / 24p	26.97	23.98		*
1,125 (1,080) / 24p	27.00	24.00		*

### Note

- Signals other than those shown above may not be displayed properly.
- The above signals are reformatted for optimal viewing on your display.

## Picture mode

- Vivid: Provides enhanced picture contrast and sharpness for viewing in a well-lit room.
- Standard: Recommended for normal viewing conditions with subdued room lighting.
- Cinema: For watching movies in a darkened room. It provides a soft, film-like picture.
- Game: For playing video game. This mode will be set automatically if “GAME” is selected from Input label setting (p. 35)
- Custom (Photo): Customizes each item according to your taste.  
Photo is displayed in JPEG menu.

### Note

- Picture mode will be automatically set to “Standard” if you change the Input label from “GAME” to other labels.
- Picture mode will be automatically set to “Game” if you change from an Input label other than “GAME” to “GAME” label.

## DIGITAL AUDIO OUT terminals

You can enjoy your home theater by connecting a Dolby Digital (5.1 channel) decoder and “Multi Channel” amplifier to the DIGITAL AUDIO OUT terminals.

### Caution

- Depending on your DVD player and DVD-Audio software the copyright protection function may operate and disable optical output.
- External speakers cannot be connected directly to PROG OUT terminals.
- When an ATSC channel is selected, the output from the DIGITAL AUDIO OUT jack will be Dolby Digital. When an NTSC channel is selected, the output will be PCM.

# Care and Cleaning

First, unplug the Power cord plug from the wall outlet.

## Display panel

The front of the display panel has been specially treated. Wipe the panel surface gently using only a cleaning cloth or a soft, lint-free cloth.

- If the surface is particularly dirty, soak a soft, lint-free cloth in diluted mild liquid dish soap (1 part mild liquid dish soap diluted by 100 times the amount of water) and then wring the cloth to remove excess liquid. Use this cloth to wipe the surface of the display panel, then wipe it evenly with a dry cloth of the same type until the surface is dry.
- Do not scratch or hit the surface of the panel with fingernails or other hard objects. Furthermore, avoid contact with volatile substances such as insect sprays, solvents, and thinner; otherwise, the quality of the surface may be adversely affected.

## Cabinet

If the cabinet becomes dirty, wipe it with a soft, dry cloth.

- If the cabinet is particularly dirty, soak the cloth in a weak mild liquid dish soap and then wring the cloth dry. Use this cloth to wipe the cabinet and then wipe it dry with a dry cloth.
- Do not allow any mild liquid dish soap to come into direct contact with the surface of the LCD TV. If water droplets get inside the unit, operating problems may result.
- Avoid contact with volatile substances such as insect sprays, solvents, and thinner; otherwise, the quality of the cabinet surface may be adversely affected or the coating may peel off. Furthermore, do not leave it for long periods in contact with articles made from rubber or PVC.

## Pedestal

### ● Cleaning

Wipe the surfaces with a soft, dry cloth. If the unit is particularly dirty, clean it using a cloth soaked with water to which a small amount of mild liquid dish soap has been added and then wipe with a dry cloth.

Do not use products such as solvents, thinner, or household wax for cleaning, as they can damage the surface coating. (If using a chemically-treated cloth, follow the instructions supplied with the cloth.)

- Do not attach sticky tape or labels, as they can make the surface of the pedestal dirty. Do not allow long-term contact with rubber, vinyl products, or the like. (Doing so will cause deterioration.)

## Power cord plug

Wipe the plug with a dry cloth at regular intervals. (Moisture and dust can lead to fire or electrical shock.)

# FAQ

Before requesting service or assistance, please follow these simple guides to resolve the problem. If the problem still persists, please contact your local Panasonic dealer or Panasonic Service Center for assistance. For details (p. 48, 49) For additional assistance, please contact us via the website at: [www.panasonic.com/contactinfo](http://www.panasonic.com/contactinfo) [www.panasonic.ca](http://www.panasonic.ca)

## White spots or shadow images (noise)

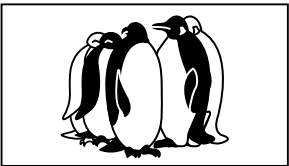
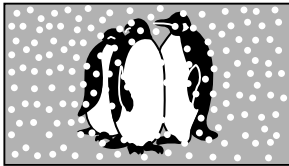

- Check the position, direction, and connection of the antenna.

## Interference or frozen digital channels (intermittent sound)



- Change the direction of antenna for digital channels.
- Check "Signal meter" (p. 33). If the signal is weak, check the antenna and consult your local dealer.

## The LCD panel moves slightly when it is pushed with a finger. A clattered sound might be heard

This is not a malfunction.

- There is some looseness around the panel to prevent the damage to the panel.

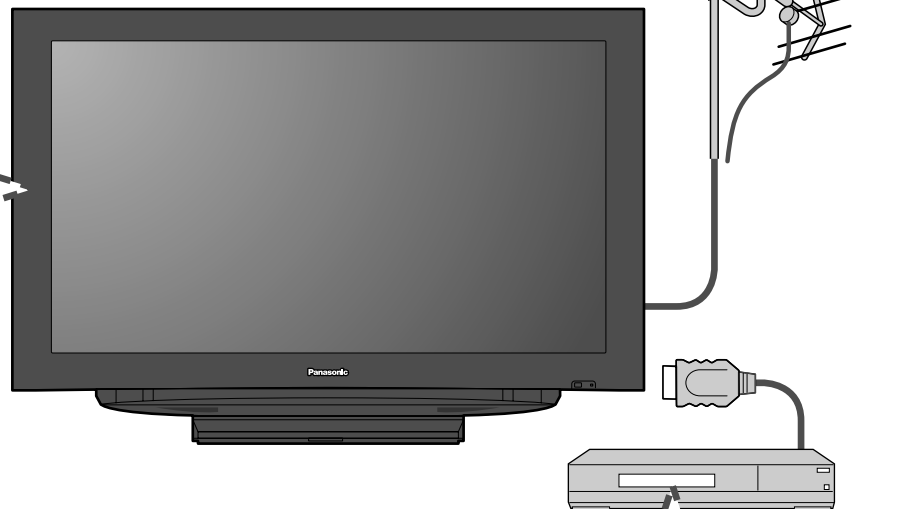

## Pictures from external equipment are distorted when the unit is connected via HDMI

- Is the HDMI cable connected properly? (p. 37, 38)
- Turn Off the TV unit and equipment, then turn them On again.
- Check an input signal from the equipment. (p. 42)
- Use equipment compliant with EIA/CEA-861/861B.

## Recording does not start immediately

- Check the settings of the recorder. For details, read the manual of the recorder.

## The remote control does not work

- Are the batteries installed correctly? (p. 6)
- Has the battery run down?

If there is a problem with your TV, please refer to the table below to determine the symptoms, then carry out the suggested check. If this does not solve the problem, please contact your local Panasonic dealer, quoting the model number and serial number (both found on the rear of the TV).

	Problem	Actions
Screen	Chaotic image, noisy	<ul style="list-style-type: none"> <li>● Check nearby electrical products (car, motorcycle, fluorescent lamp).</li> </ul>
	No image can be displayed	<ul style="list-style-type: none"> <li>● Check Picture menu (p. 22)</li> <li>● Check the cable connections.</li> <li>● Check that the correct input has been selected.</li> </ul>
	Only spots are displayed instead of images	<ul style="list-style-type: none"> <li>● Check the channel settings. (p. 32)</li> <li>● Check the antenna cables.</li> </ul>
	Neither image nor sound is produced	<ul style="list-style-type: none"> <li>● Is the power cord plugged into the outlet?</li> <li>● Is the TV unit turned On?</li> <li>● Check Picture menu (p. 22) and volume.</li> <li>● Check the AV cable connections.</li> <li>● Check that the correct input has been selected.</li> </ul>
Sound	No sound is produced	<ul style="list-style-type: none"> <li>● Are the speakers' cables connected correctly?</li> <li>● Is "Sound Mute" active? (p. 12)</li> <li>● Is the volume set to the minimum?</li> <li>● Is "Speaker output" set to "Off"? (p. 22)</li> <li>● Change "SAP" settings. (p. 16)</li> <li>● Check "HDMI 1 in", "HDMI 2 in" or "HDMI 3 in" settings. (p. 22)</li> </ul>
	Sound is unusual	<ul style="list-style-type: none"> <li>● Set "SAP" setting to "Stereo" or "Mono."</li> <li>● Check the HDMI device connected to the unit.</li> <li>● Set the audio setting of the HDMI device to "Linear PCM."</li> <li>● If digital sound connection has a problem, select analog sound connection.</li> </ul>
Other	The main unit is hot.	<ul style="list-style-type: none"> <li>● The main unit radiates heat and some of the parts may become hot. This is not a problem for performance or quality. Set up in a location with good ventilation. Do not cover the ventilation holes of the TV with a tablecloth, etc., and do not place on top of other equipment.</li> </ul>

# Specifications

		TC-37LZ85
<b>Power Source</b>		AC 120 V, 60 Hz
<b>Power Consumption</b>	<b>Maximum Standby condition</b>	222 W 0.2 W
	<b>Aspect Ratio</b>	16:9
<b>Display panel</b>	<b>Visible screen size (W x H x Diagonal)</b>	37" class (37.0 inches measured diagonally) 32.2" x 18.1" x 37.0" (819 mm x 460 mm x 940 mm)
	<b>(No. of pixels)</b>	2,073,600 (1,920 (W) x 1,080(H)) [5,760 x 1,080 dots]
	<b>Speaker</b>	1 way 2 speakers slim under SP System
<b>Sound</b>	<b>Audio Output</b>	20 W [10 W + 10 W] ( 10 % THD )
	<b>Headphones</b>	M3 (3.5 mm) Jack x 1
<b>Channel Capability-ATSC/NTSC (Digital/Analog)</b>		VHF/ UHF: 2 - 69, CATV: 1 - 135
<b>Operating Conditions</b>		Temperature: 32 °F – 95 °F (0 °C – 35°C) Humidity: 20 % – 80 % RH (non-condensing)
<b>Connection Terminals</b>	<b>VIDEO IN 1</b>	VIDEO: RCA PIN Type x 1 1.0 V[p-p] (75 Ω) S VIDEO: Mini DIN 4-pin Y: 1.0 V[p-p] (75 Ω) C: 0.286 V [p-p] (75 Ω) AUDIO L - R: RCA PIN Type x 2 0.5 V [rms]
	<b>VIDEO IN 2</b>	VIDEO: RCA PIN Type x 1 1.0 V [p-p] (75 Ω) AUDIO L - R: RCA PIN Type x 2 0.5 V [rms]
	<b>COMPONENT IN 1-2</b>	Y: 1.0 V [p-p] (including synchronization) PB, PR: ±0.35 V [p-p] AUDIO L-R: RCA PIN Type x 2 0.5 V [rms]
	<b>HDMI 1-3</b>	TYPE A Connector x 3 ● This TV supports "HDAVI Control 3" function.
	<b>Card slot</b>	SD CARD slot x 1
	<b>PROG OUT</b>	AUDIO L - R: RCA PIN Type x 2 0.5 V [rms]
	<b>DIGITAL AUDIO OUT</b>	PCM / Dolby Digital, Fiber Optic
<b>FEATURES</b>		3D Y/C Digital Comb Filter, CLOSED CAPTION, V-Chip HDMI (HDAVI Control 3) Vesa compatible Photo viewer
<b>Dimensions (W x H x D)</b>	<b>Including TV stand</b>	36.7" x 25.4" x 11.7" (931 mm x 644 mm x 295 mm)
	<b>TV Set only</b>	36.7" x 23.8" x 4.3" (931 mm x 602 mm x 108 mm)
<b>Mass</b>		48.6 lb. (22 kg) NET

[TC-37LZ85]

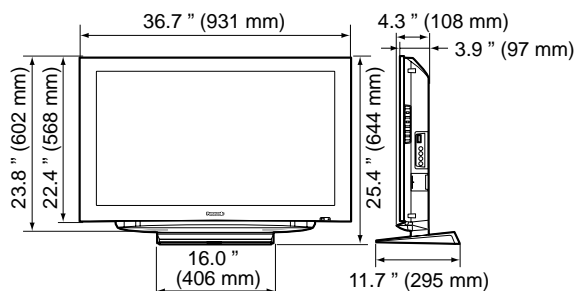

**Note**

● Design and Specifications are subject to change without notice. Mass and Dimensions shown are approximate.

# Limited Warranty (for U.S.A.)

PANASONIC CONSUMER ELECTRONICS COMPANY,  
DIVISION OF:  
PANASONIC CORPORATION OF NORTH AMERICA  
One Panasonic Way  
Secaucus, New Jersey 07094

PANASONIC SALES COMPANY,  
DIVISION OF:  
PANASONIC PUERTO RICO, INC.  
Ave. 65 de Infanteria, Km. 9.5  
San Gabriel Industrial Park  
Carolina, Puerto Rico 00985

## Panasonic LCD Televisions Limited Warranty

### Limited Warranty Coverage

If your product does not work properly because of a defect in materials or workmanship, Panasonic Consumer Electronics Company or Panasonic Puerto Rico, Inc. (collectively referred to as "the warrantor") will, for the length of the period indicated on the chart below, which starts with the date of original purchase ("warranty period"), at its option either (a) repair your product with new or refurbished parts, or (b) replace it with a new or a refurbished product. The decision to repair or replace will be made by the warrantor.

LCD TV CATEGORIES	PARTS	LABOR	SERVICE
Up to 20" (diagonal)	1 (ONE) YEAR	1 (ONE) YEAR	Carry-In or Mail-in
21" (diagonal) and larger			In Home or Carry-in / Mail in

During the "Labor" warranty period there will be no charge for labor. During the "Parts" warranty period, there will be no charge for parts. You must carry-in or mail-in your product during the warranty period. If non-rechargeable batteries are included, they are not warranted. This warranty only applies to products purchased and serviced in the United States or Puerto Rico. This warranty is extended only to the original purchaser of a new product which was not sold "as is". A purchase receipt or other proof of the original purchase date is required for warranty service.

### In-Home or Carry-in Service

For In-Home or Carry-In Service in the United States call 1-800-211-PANA(7262) or visit the Panasonic web Site: <http://www.panasonic.com>.

For assistance in Puerto Rico call Panasonic Puerto Rico, Inc. (787)-750-4300 or fax (787)-768- 2910.

In-Home service requires clear, complete and easy access to the product by the authorized servicer and does not include removal or re-installation of an installed product. It is possible that certain in-home repairs will not be completed in-home, but will require that the product, or parts of the product, be removed for shop diagnosis and/or repair and then returned.

### Limited Warranty Limits And Exclusions

This warranty ONLY COVERS failures due to defects in materials or workmanship, and DOES NOT COVER normal wear and tear or cosmetic damage, nor does it cover markings or retained images on the LCD panel resulting from viewing fixed images (including, among other things, letterbox pictures on standard 4:3 screen TV's, or non-expanded standard 4:3 pictures on wide screen TV's, or onscreen data in a stationary and fixed location). The warranty ALSO DOES NOT COVER damages which occurred in shipment, or failures which are caused by products not supplied by the warrantor, or failures which result from accidents, misuse, abuse, neglect, bug infestation, mishandling, misapplication, alteration, faulty installation, set-up adjustments, misadjustment of consumer controls, improper maintenance, power line surge, lightning damage, modification, or commercial use (such as in a hotel, office, restaurant, or other business), rental use of the product, service by anyone other than a Factory Service Center or other Authorized Servicer, or damage that is attributable to acts of God.

**THERE ARE NO EXPRESS WARRANTIES EXCEPT AS LISTED UNDER "LIMITED WARRANTY COVERAGE". THE WARRANTOR IS NOT LIABLE FOR INCIDENTAL OR CONSEQUENTIAL DAMAGES RESULTING FROM THE USE OF THIS PRODUCT, OR ARISING OUT OF ANY BREACH OF THIS WARRANTY.** (As examples, this excludes damages for lost time, cost of having someone remove or re-install an installed unit if applicable, or travel to and from the servicer. The items listed are not exclusive, but are for illustration only.) **ALL EXPRESS AND IMPLIED WARRANTIES, INCLUDING THE WARRANTY OF MERCHANTABILITY, ARE LIMITED TO THE PERIOD OF THE LIMITED WARRANTY.**

Some states do not allow the exclusion or limitation of incidental or consequential damages, or limitations on how long an implied warranty lasts, so the exclusions may not apply to you.

This warranty gives you specific legal rights and you may also have others rights which vary from state to state. If a problem with this product develops during or after the warranty period, you may contact your dealer or Service Center. If the problem is not handled to your satisfaction, then write to the warrantor's Consumer Affairs Department at the addresses listed for the warrantor.

**PARTS AND SERVICE (INCLUDING COST OF AN IN-HOME SERVICE CALL, WHERE APPLICABLE) WHICH ARE NOT COVERED BY THIS LIMITED WARRANTY ARE YOUR RESPONSIBILITY.**

# Customer Services Directory (for U.S.A.)

## Customer Services Directory

Obtain Product Information and Operating Assistance; locate your nearest Dealer or Service Center; purchase Parts and Accessories; or make Customer Service and Literature requests by visiting our Web Site at:

**<http://www.panasonic.com/consumersupport>**

or, contact us via the web at:

**<http://www.panasonic.com/contactinfo>**

You may also contact us directly at:

1-888-211-PANA (7262)

Monday-Friday 9 am-9 pm; Saturday-Sunday 10 am-7 pm, EST.

■ For hearing or speech impaired TTY users, TTY: 1-877-833-8855

## Accessory Purchases

Purchase Parts, Accessories and Instruction Books on line for all Panasonic Products by visiting our Web Site at:

**<http://www.pstc.panasonic.com>**

or, send your request by E-mail to:

**[npcparts@us.panasonic.com](mailto:npcparts@us.panasonic.com)**

You may also contact us directly at:

1-800-332-5368 (Phone) 1-800-237-9080 (Fax Only) (Monday - Friday 9 am to 8 pm, EST.)

Panasonic Service and Technology Company

20421 84th Avenue South,

Kent, WA 98032

(We Accept Visa, MasterCard, Discover Card, American Express, and Personal Checks)

■ For hearing or speech impaired TTY users, TTY: 1-866-605-1277

## Service in Puerto Rico

Panasonic Puerto Rico, Inc.

Ave. 65 de Infantería, Km. 9.5, San Gabriel Industrial Park,

Carolina, Puerto Rico 00985

Phone (787)750-4300, Fax (787)768-2910



# Limited Warranty (for Canada)

Panasonic Canada Inc.

## PANASONIC PRODUCT - LIMITED WARRANTY

Panasonic Canada Inc. warrants this product to be free from defects in material and workmanship and agrees to remedy any such defect for a period as stated below from the date of original purchase.

Plasma TV / Monitor	In-home service	One (1) year, parts (including Plasma Panel) and labour.
LCD TV (26 in & over)	In-home service	One (1) year, parts (including LCD Panel) and labour.

In-home Service will be carried out only to locations accessible by roads and within 50 km of an authorized Panasonic service facility.

### LIMITATIONS AND EXCLUSIONS

This warranty does not apply to products purchased outside Canada or to any product which has been improperly installed, subjected to usage for which the product was not designed, misused or abused, damaged during shipping, or which has been altered or repaired in any way that affects the reliability or detracts from the performance, nor does it cover any product which is used commercially. Dry cell batteries are also excluded from coverage under this warranty.

This warranty is extended to the original end user purchaser only. A purchase receipt or other proof of date of original purchase is required before warranty service is performed.

**THIS EXPRESS, LIMITED WARRANTY IS IN LIEU OF ALL OTHER WARRANTIES, EXPRESS OR IMPLIED, INCLUDING ANY IMPLIED WARRANTIES OF MERCHANTABILITY AND FITNESS FOR A PARTICULAR PURPOSE. IN NO EVENT WILL PANASONIC CANADA INC. BE LIABLE FOR ANY SPECIAL, INDIRECT OR CONSEQUENTIAL DAMAGES.**

In certain instances, some jurisdictions do not allow the exclusion or limitation of incidental or consequential damages, or the exclusion of implied warranties, so the above limitations and exclusions may not be applicable.

In-home service requires clear, complete and easy access to the product by the Authorized Servicentre and does not include removal or re-installation of an installed product. If removal is required to service the product, it will be at the discretion of the Servicentre and in no event will Panasonic Canada Inc. or the Servicentre be liable for any special, indirect or consequential damages.

### WARRANTY SERVICE

For product operation and information assistance, please contact:

Our Customer Care Centre: 1-800 #: 1-866-330-0014  
Email link: [www.vieraconciierge.ca](http://www.vieraconciierge.ca)

**FOR PRODUCT REPAIRS**, please contact Viera Customer Care Agent using the above contact info.

### IF YOU SHIP THE PRODUCT TO A SERVICENTRE

Carefully pack and send prepaid, adequately insured and preferably in the original carton.  
Include details of the defect claimed, and proof of date of original purchase.

This product has a fluorescent lamp that contains mercury. Disposal may be regulated in your community due to environmental considerations. For disposal or recycling information, please contact your local authorities, or the Electronic Industries Alliance:  
<http://www.eiae.org>.

Este producto tiene una lámpara fluorescente que contiene mercurio. Debido a consideraciones ambientales, puede que deshacerse de este material esté regulado en su comunidad. Para obtener información sobre cómo deshacerse o reciclar este material, póngase en contacto con las autoridades de su localidad o con Electronics Industries Alliance:  
<http://www.eiae.org>.

#### Customer's Record

The model number and serial number of this product can be found on its back cover. You should note this serial number in the space provided below and retain this book, plus your purchase receipt, as a permanent record of your purchase to aid in identification in the event of theft or loss, and for Warranty Service purposes.

Model Number \_\_\_\_\_

Serial Number \_\_\_\_\_

#### Anotación del cliente

El modelo y el número de serie de este producto se encuentran en su panel posterior. Deberá anotarlos en el espacio provisto a continuación y guardar este manual, más el recibo de su compra, como prueba permanente de su adquisición, para que le sirva de ayuda al identificarlo en el caso de que le sea sustraído o lo pierda, y también para disponer de los servicios que le ofrece la garantía.

Modelo \_\_\_\_\_

Número de serie \_\_\_\_\_

**Panasonic Consumer Electronics Company,**  
**Division of Panasonic Corporation of North America**  
One Panasonic Way, Secaucus  
New Jersey 07094 U.S.A.

**Panasonic Puerto Rico, Inc.**  
Ave. 65 de Infantería, Km. 9.5  
San Gabriel Industrial Park  
Carolina, Puerto Rico 00985

**Panasonic Canada Inc.**  
5770 Ambler Drive  
Mississauga, Ontario  
L4W 2T3 CANADA