

Panasonic

Colour Television

TX-25V20M

TX-25V20Z

Operating Instructions

Please read these instructions completely before operating this set

TQB4G0104

Contents

Warnings and Cautions	1
Battery Installation, Replacement and Precautions	2
Location of Control (on the TV Set)	3
General Operation on the TV Set	
TV/AV Selection Button	4
Volume Up and Down Buttons	4
Programme Number Up and Down Buttons	4
Preset (PRE.) Button	4
Function (FUNC.) and System (SYS.) Buttons	5
How to Tune in Your TV set (Automatic and Manual Search)	6
Fine Tuning Operation	7
How to Skip Unused Programme Number	8
Remote Control Transmitter (for TV)	9
Remote Control Transmitter Operation (for TV)	
Power (Stand-by) Button	10
Programme Number Up or Down Buttons	10
Volume Up or Down Buttons	10
Normalization (NORM.) Button	10
Function (P) Button	11
Sound Control Function (S) Button	11
Recall Button	11
Stereo/Bilingual Selection Button	12
Off-Timer Button	13
Direct Programme Number Selection Buttons	13
Two Digit Programme Number Selection Button	13
TV/AV Selection Button	14
Sound Mute Button	14
Surround Button	14

Contents

Remote Control Transmitter (for VCR)	15
Remote Control Transmitter Operation (for VCR)	16
Remote Control Transmitter (for Teletext)	17
Remote Control Transmitter Operation (for Teletext)	
TV/TXT Button	18
INDEX Button	18
Direct Programme Number Selection Buttons	19
Programme Number Up or Down Buttons	19
FULL/TOP/BOTTOM (F/T/B) Button	19
COLOUR Button	20
RESET Button	20
MIX Button	20
HOLD Button	20
FAVOURITE PAGE (F/P) Button	21
REVEAL Button	21
DISPLAY CANCEL Button	21
FAST TEXT (LIST/F.TEXT) Button	22
TIME TEXT Button	23
LIST MODE ACCESS	24
TEXT SUB PAGE ACCESS	25
How to Connect An External Antenna	26
How to Connect the Audio and Video Terminals	27
How to Connect the Audio and S-Video Terminals	28
How to Connect the Audio, Video and S-Video Terminals	29
Troubleshooting	30
Specifications	31~32
General Informations	32

Dear Panasonic Customer

Welcome to the Panasonic family of customers. We hope that you will have many years of enjoyment from your new colour television.

Warnings and Cautions

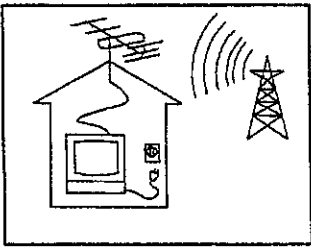

The TV set can be operated on AC Auto 110 ~ 240 V, 50/60 Hz.

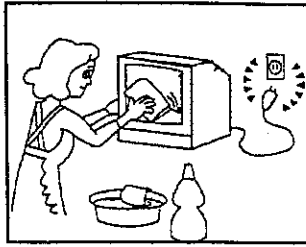

The cabinet and picture tube can be kept in good condition by simply wiping with a clean, soft cloth moistened with mild detergent and water. Do not use solutions containing benzol, petroleum or a chemical cloth. For safety, remove the plug from the wall outlet.

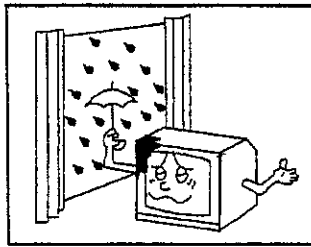

To prevent damage which may result in fire or electrical shock, do not expose the TV set to rain or excessive moisture.

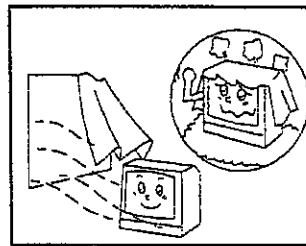

Adequate ventilation is essential to prevent failure of electrical components.

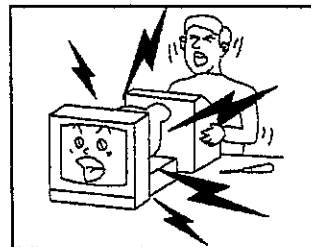

High Voltage :

Do not remove the rear cover, as live parts are accessible when it is removed.

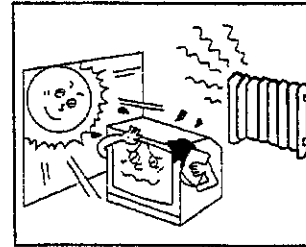

Avoid exposing the TV set to direct sunlight and other source of heat.

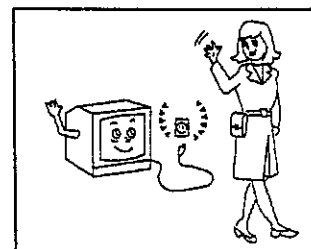

Remove the plug from the wall outlet (Power point) when the TV set is not used for a prolonged period of time.

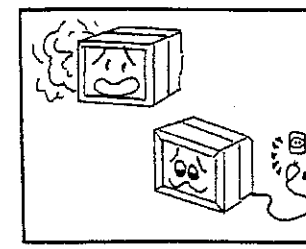

Do not used this set if abnormal operation occurs.
EX: smoke, odd sounds or smells, turn the power switch off and disconnect the AC power if you notice any unusual operation.

Battery Installation and Replacement

Battery Installation

Batteries : Use two " R6 " size dry cells.

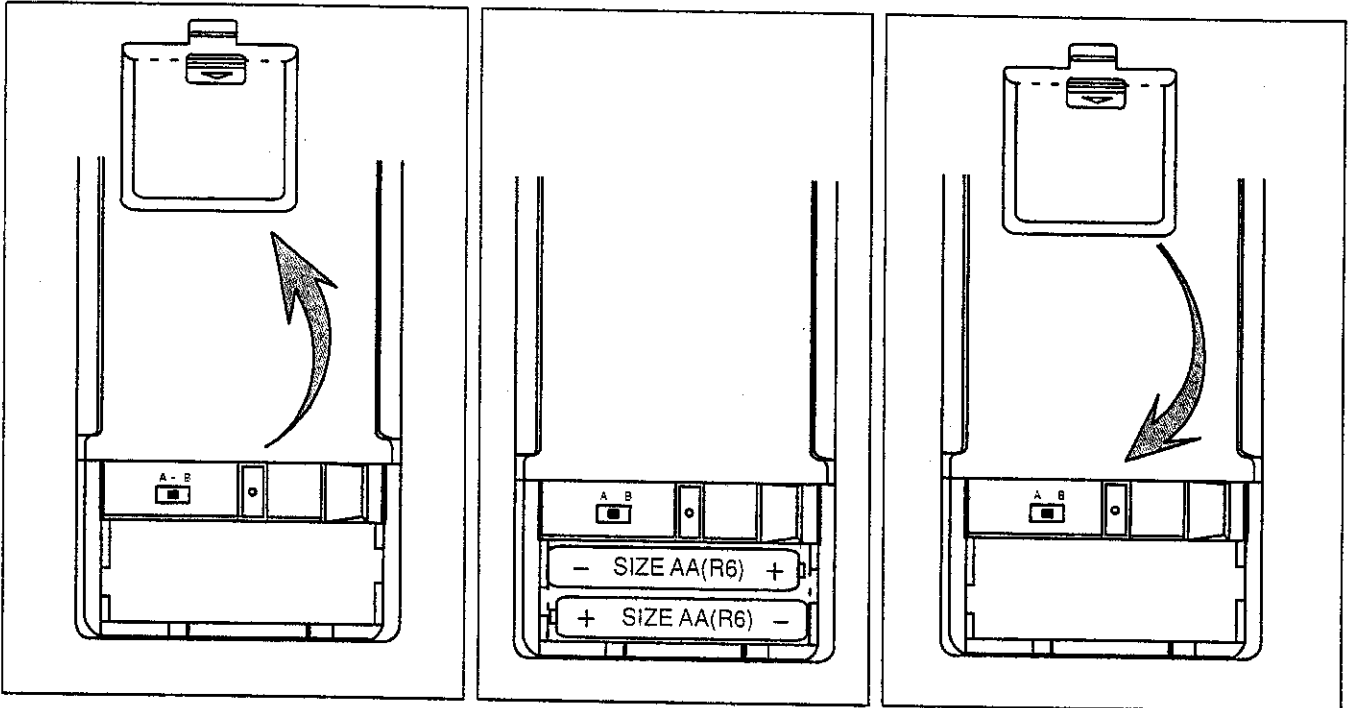

1. Remove the remote control battery compartment lid by pressing it to the bottom side.
2. Insert the batteries correctly by observing the polarities (+) and (-).
3. Replace the cover.

Battery Precautions

Incorrect use of batteries can cause electrolyte leakage which will corrode the remote control transmitter or cause the batteries to burst.

The following precautions must be carefully observed.

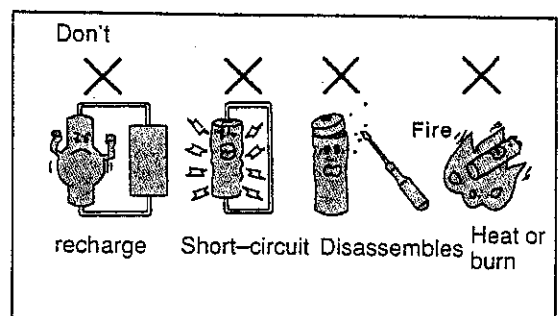
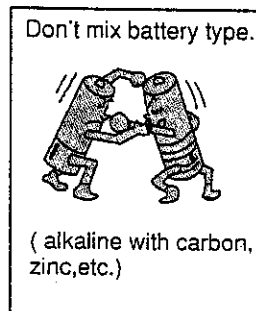
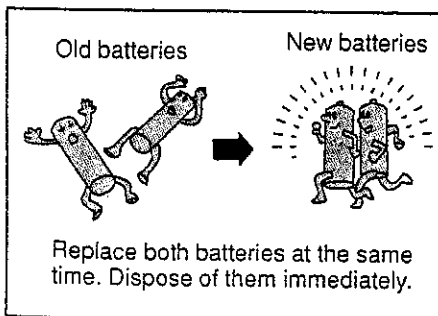

Locations of Control

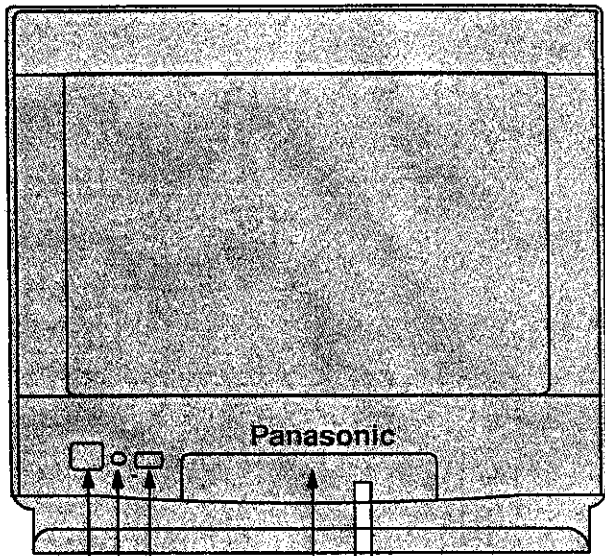

Push here to open
 Remote Control Sensor
 Power On / Stand-by indicator
 Power Switch Button

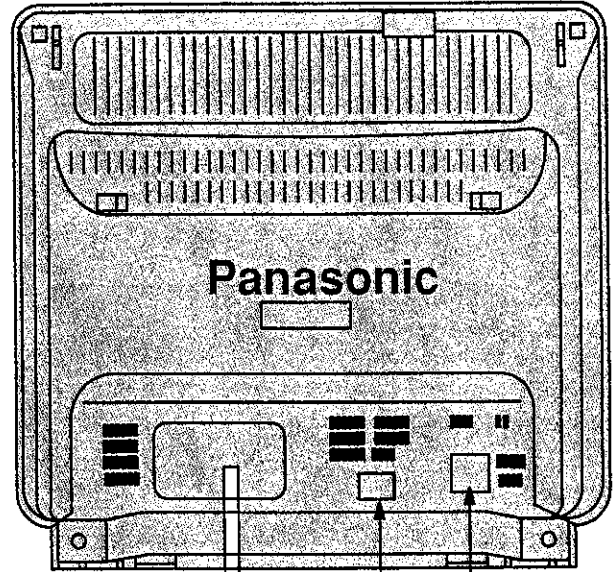

Model Name Plate
 Serial Number

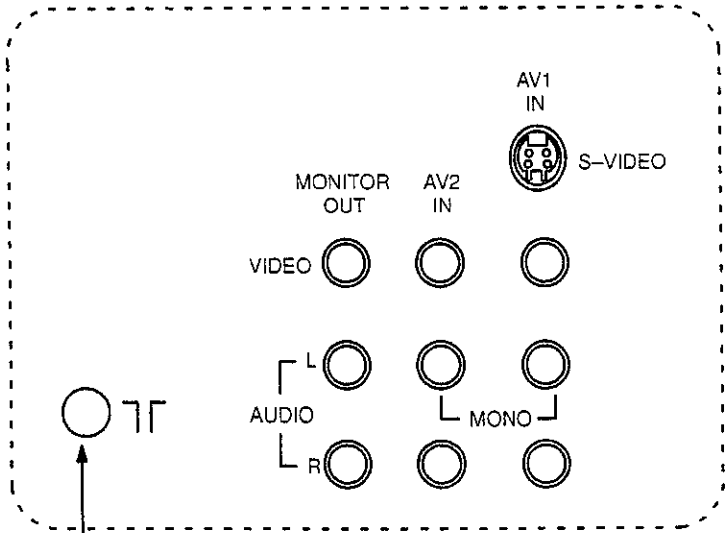

Aerial Terminal

(Behind the door)

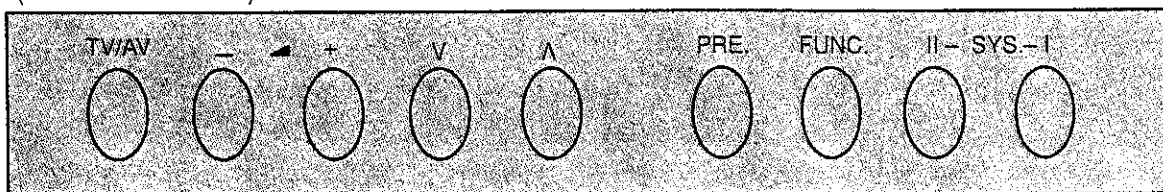

1 2 3 4 5 6

Note : Operating instructions for numbers 1 ~ 6 are explained on page 4 ~ 5.

General Operation on the TV Set

1. TV/AV Selection Button



Press the button to select the TV mode, AV1 mode or AV2 mode.

The sequence is as below :

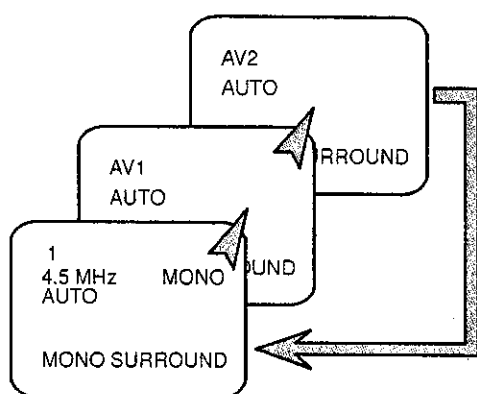

When TV mode is selected, the last Programme Number, Sound System, Colour System, Surround mode and Sound output (depending on type of broadcasting transmission) mode will appear.

When AV mode is selected, the last AV mode, Colour System and Surround mode will appear.

If the S-Video cable is connected to S-Video Terminal (for AV1 only), the selected AV mode, " S-Video " symbol (AV1 only) and Surround mode will appear on the screen.

e.g. S-Video cable is connected to S-Video terminal and AV1 is selected.

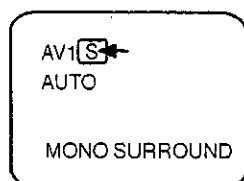

2. Volume Up or Down Buttons

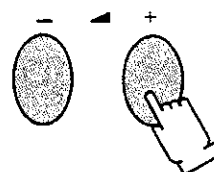

Press these buttons to adjust the sound level.

These buttons also can be used for level Up or Down adjustment in the Function and Sound Control Function mode.

3. Programme Number Up or Down Buttons

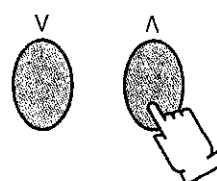

Press these buttons to select next higher or next lower Programme Number.

4. Preset (PRE.) Button



Please refer to page 6~ 7 about this button.

General Operation on the TV Set

5. Function (FUNC.) Button



By pressing this button repeatedly, the Colour Control Function and Sound Control Function will be displayed.

All functions are set at factory preset level (is showed in yellow colour).

Press the Volume Up " + " or Down " - " buttons to adjust the level of selected functions.

The sequence is as follows :

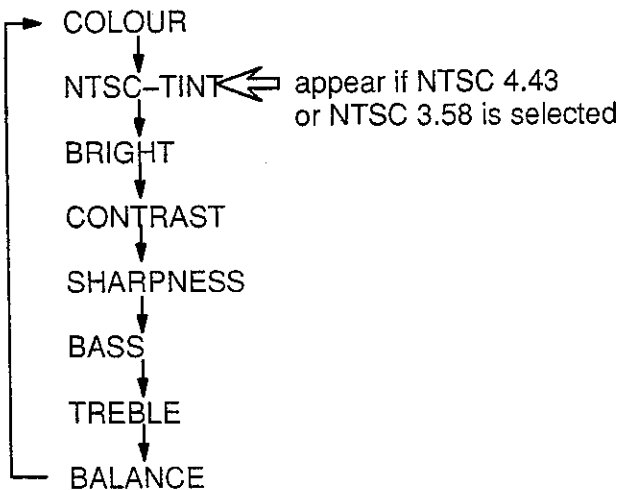

6. System Buttons

System I Select Operation

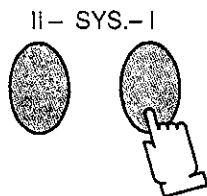

The System button is automatically set to the AUTO mode. If a clear picture cannot be obtained when receiving broadcast or AV signal, press this button repeatedly until the optimum picture is received. Press System I button to the appropriate mode if black and white picture received is shaking slightly. When this button is pressed, you change the on-screen display as shown below :

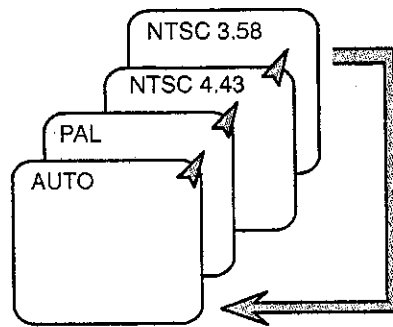

System II Select Operation (for TV mode only)

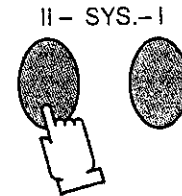

When the sound is not clear or no sound is produced on programme number selected, press this button repeatedly until the optimum sound is obtained. The selected system mode on each programme number position is automatically memorized.

The on-screen change as follows :

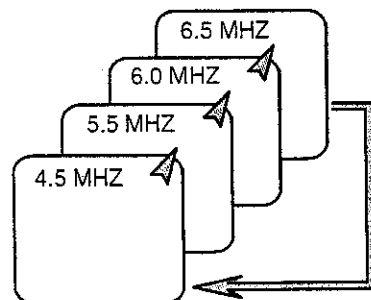

Tuning Procedure

How to Tune in Your TV Set (Automatic Search)

1. The TV set must be turned on.



2. Press the "PRE." button until the on-screen display appears as follows :

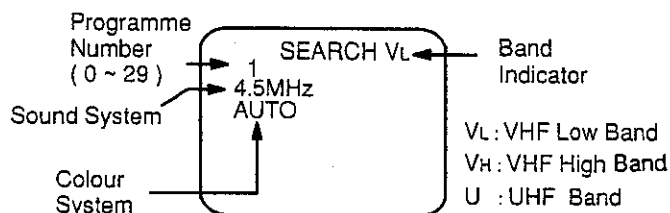
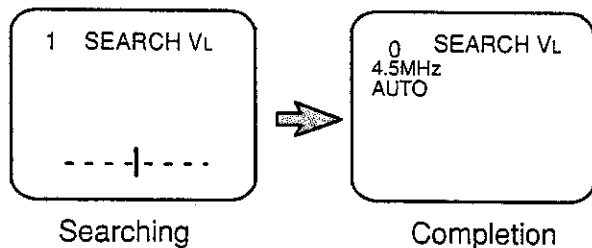

Figure 1.



3. Press the "FUNCTION" button .
The on-screen display appears as shown :



The best tuning position is automatically memorized.

4. Press the "PRE." button twice to return the TV set to the normal operating mode.

A maximum of 30 Programme Numbers (0~29) can be programmed.

How to Tune in Your TV Set (Manual Search)

1. The TV set must be turned on.



2. Press the "PRE." button until the on-screen display appears as shown in **Figure 1**. Press either the Programme Number Up or Down button to select the desired Programme Number on which you want to tune the TV station of your choice.

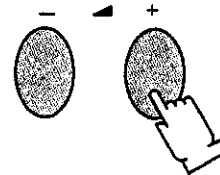

3. Press either the Level Adjustment Up " + " or Down " - " buttons, the TV station broadcasting on the next higher or lower frequency will be automatically tuned and memorized.

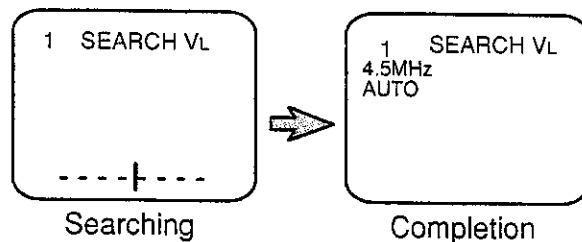

If an undesired TV station is received, press the same button again until the desired TV station is tuned.

4. Use the Programme Number Up or Down buttons to select the next Programme Number that you wish to tune a TV programme on.
Repeat step 2 and 3 to tune all the available TV stations on the remaining programme number.
Ensure that a new programme number is set (step 2) before tuning the next station.
5. Press the "PRE." button twice to return the TV set to the normal operating mode.

Fine Tuning Operation

Under normal reception condition, this function is not used. However, in areas of poor reception or constant interference, a slight adjustment on the fine tuning can improve the picture and sound quality.

How to set the Fine Tuning Operation

PRE.



1. Press the "PRE." button twice.
The on-screen will appear as shown :

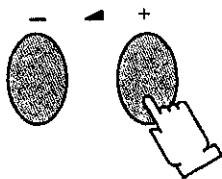
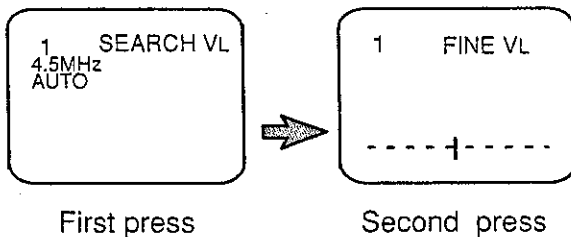

2. Press either the Level Adjustment Up "+" or Down "-" button (Volume Buttons) continuously.

When the above fine tuning operation has been performed, the "■" symbol appear on the left of Channel Number.
The AFC function is deactivated.

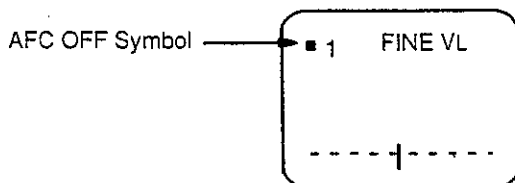

3. Press the "PRE." button once to return the TV set to the normal operating mode.

How to Cancel the Fine Tuning Operation

If you want to reset this Programme Number to the automatically tuned condition with the AFC activated, perform the following steps :

PRE.



1. Press the "PRE." button once.
The on-screen will appear as shown :

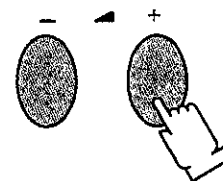
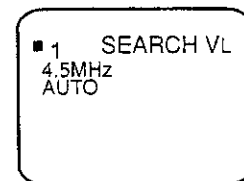

2. Press either the Level Adjustment Up "+" or Down "-" button (Volume Buttons).

3. Press the "PRE." button twice.

How to Skip Unused Programme Number

Programme Number Skip Operation

This function makes it possible to skip the Programme Number on which no TV stations are received. This function is effective only when the Programme Number Up or Down buttons is pressed, either on the TV set or the remote control.

How to set the Skip Operation



1. Press the " PRE. " button once.
The on-screen will appear as shown below :

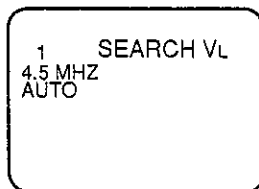

2. Select the Programme Number you want to skip.



3. Press the " TV/AV " button .
If more Programme Numbers are to be skipped, repeat step 2 and 3.

The on-screen appears as below :

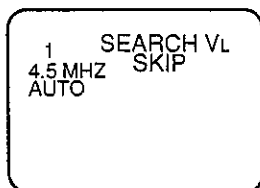

4. Press the " PRE. " button twice after the skip operation is completed.

How to cancel the Skip Operation



1. Press the " PRE. " button once.
2. Select the skipped Programme Number Up " ^ " or Down " v " button.



3. Press the " TV/AV " button .
If more Programme Numbers are to be cancelled, repeat step 2 and 3.
4. Press the " PRE. " button twice after the cancel operation is completed.

Remote Control Transmitter (for TV)

- 1. Stand-by Power Button
- 2. Programme Number Up or Down Buttons
- 3. Volume Up or Down Buttons
- 4. Normalization Button
- 5. Function Button
- 6. Sound Control Function Button
- 7. Recall Button
- 8. Stereo/Bilingual Button
- 9. Off - Timer Button
- 10. Direct Programme Number Selection Buttons
- 11. Two Digit Programme Number Selection Button
- 12. TV/AV Button
- 13. Sound Mute Button
- 14. Surround Button

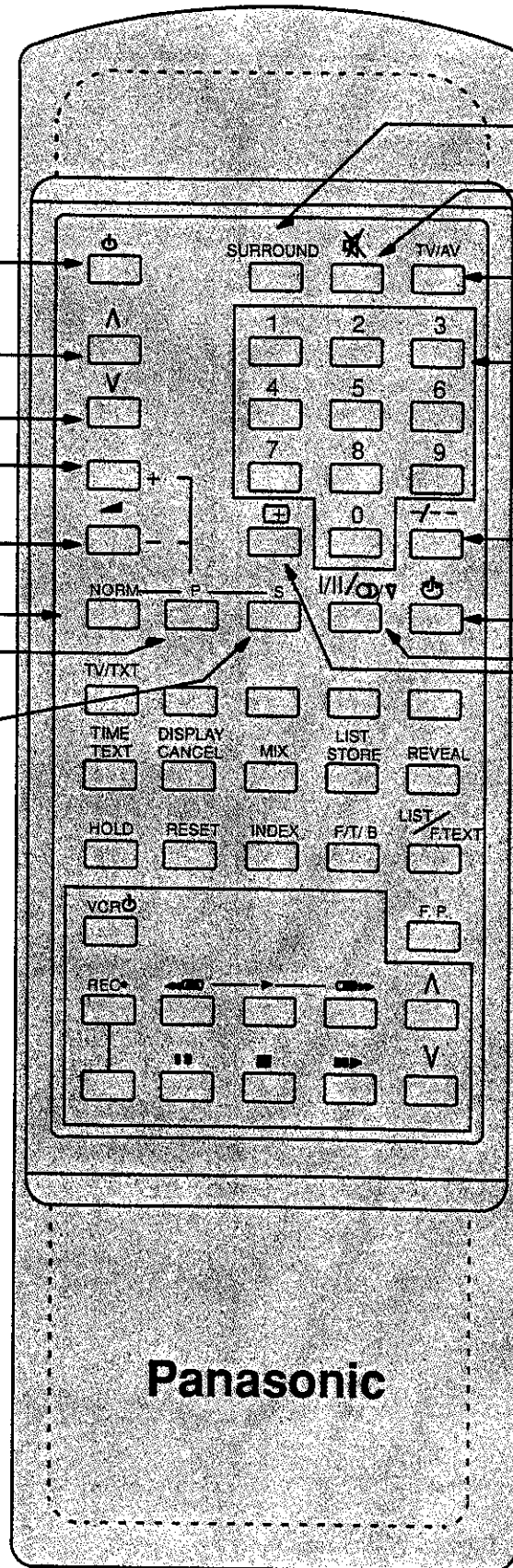

Remote Control Transmitter Operation (for TV)

1. Power (Stand-by) Button

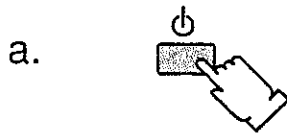

Press this button to switch the TV set off.

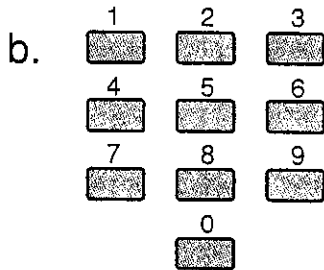

To switch back on perform one of the following:

- Press Stand-by button again.
- Press one of these Direct Programme Number Selection buttons on the remote control.
- Press Programme Number Up / Down on the TV set or on the remote control.

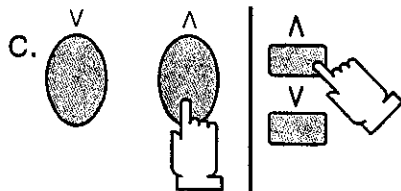

Note : Do not leave your TV set in stand-by mode for a long period of time. It is better to switch your TV off when you are away.

2. Programme Number Up or Down Buttons

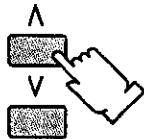

Press these buttons to select next higher or next lower Programme Number.

3. Volume Up or Down Buttons

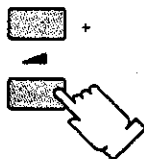

Press the Volume Up or Down buttons to adjust the sound level.

These buttons also can be used for level Up or Down adjustment in the Function mode and Sound Control Function mode.

4. Normalization (NORM.) Button



This button can be used for setting the Colour, Tint (Auto, NTSC only), Brightness, Contrast, Sharpness, Bass, Treble and Balance.

When this button is pressed, all functions setting are normalized or reset to the factory preset level (is showed in yellow colour).

e.g. When this button is pressed after adjusting colour function.

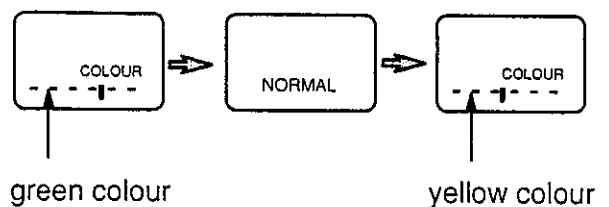

Remote Control Transmitter Operation (for TV)

5. Function (P) Button

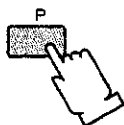

By pressing the Function button repeatedly, the on-screen display will be changed as shown below.

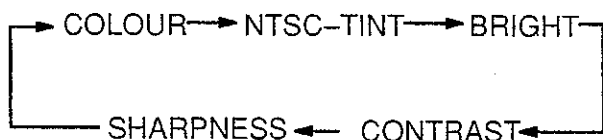

Press the Volume Up " + " or Down " - " buttons during display to adjust the level selected function.

Note :

NTSC-TINT will appear on the screen if NTSC 4.43 or NTSC 3.58 is selected.

6. Sound Control Function (S) Button

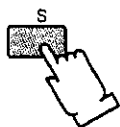

By pressing this button, the Sound Control function will be displayed on the factory preset level (is showed in yellow colour).

The sequence is as below :

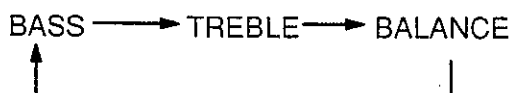

The level can be adjusted by pressing Volume Up " + " or Down " - " buttons.

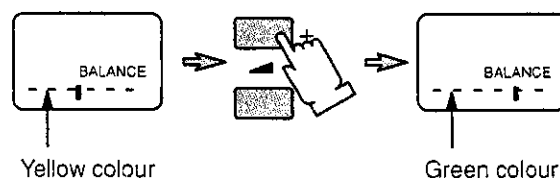

7. Recall Button

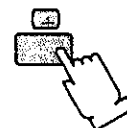

Press the Recall button to activate the on-screen display.

The current Programme Number, Sound System, Colour System, Surround mode and Sound output mode (depending on type of broadcasting transmission) will be displayed on the screen. After few seconds, the on-screen display of Sound System, Colour System, Surround mode and Sound output will disappear automatically.

Press it again to cancel the current Programme Number.

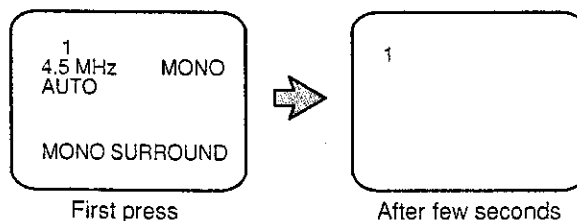

Note : In the AV mode, a blue colour screen appear, if there is no AV signal, when the recall function is off.

Remote Control Transmitter Operation (for TV)

8. Stereo/Bilingual Sound Selection Button



By using this button, the "STEREO" or "MONO" mode can be selected.

When this button is pressed, on-screen indication will change depending on type of broadcasting transmission.

The on-screen will display as follows :

1. Regular Broadcast (Standard Audio).

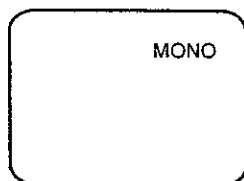

2. NICAM MONO I (MAIN [I]).

Press the button to select "MAIN [I]" or "MONO" audio signal.

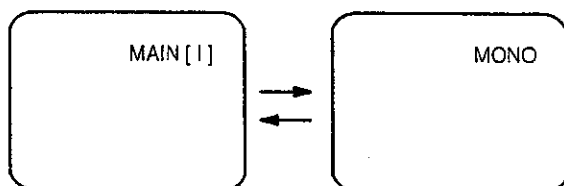

3. NICAM STEREO

Press the button to select "STEREO" or "MONO" mode.

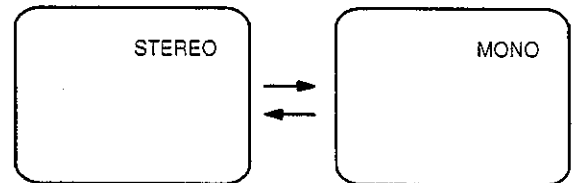

4. NICAM DUAL MONO (MAIN [I] / SUB [II]).

Press the button to select the "MAIN [I]" or "SUB [II]" or "MONO".

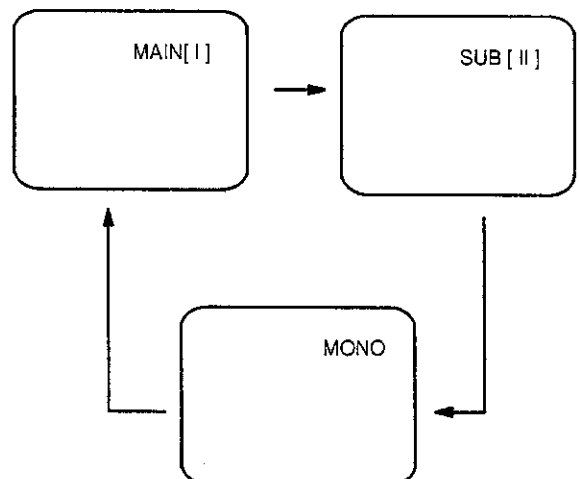

Note :

1. If the stereo signal is weak or the receiving are poor, it is recommended to switch to the "MONO" mode.
2. When the power is switched ON, the mode is preset at either "MAIN [I]" or "STEREO."
3. Even when the contents of the receiving signal changes, selection mode is kept intact.
4. When the receiving conditions deteriorate, listening will be easier if the mode is set to the "MONO" position.

Remote Control Transmitter Operation (for TV)

9. Off-Timer Button



The TV set can be preset to switch off after a fixed period of time.

Press the Off-Timer button will set the TV set for 30 minutes. Press again to set 60 minutes and so on. The selected time will be displayed on the bottom right of the screen.

The sequence is as follows :

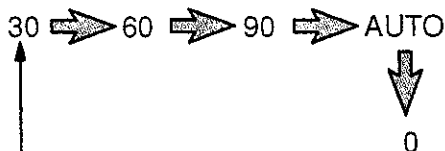

e.g. Setting 30 minutes off-timer.

The selected time disappear after a few seconds and it's will be displayed when the Recall button is pressed. This will give you the remaining time. When the Off-Timer reaches its last 3 minutes, it start blinking before go to stand-by condition.

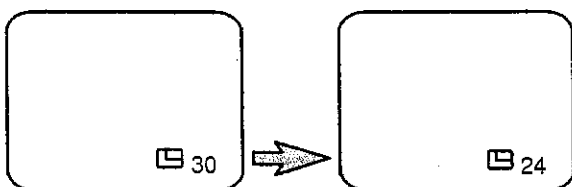

(after 6 minutes)

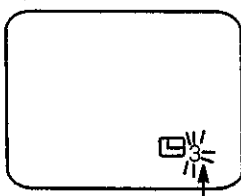

The selected time start blinking at last 3 minutes before stand-by condition.

Note : Setting Off – Timer to AUTO mode.

If the set is not switched off, when the TV station ends broadcasting, it will automatically go to stand-by condition after 5 minutes. This AUTO mode will not operate when the TV receiver is in AV mode.

How to cancel the off-timer setting

1. Set the pre-set time condition to "0" mode by pushing the "off-timer" button.
2. Turning the TV set off, using the button on the remote control or the power switch button on the TV set.

10. Direct Programme Number Selection Buttons

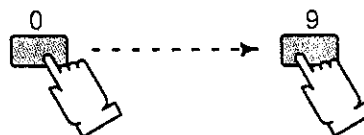

Press one of these buttons to select the required Programme Number between 0 to 9.

11. Two Digit Programme Number Selection Button

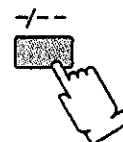

Press the button and following by the required numbers to select Programme Number from 10 to 29.

e.g. To select Programme Number 12.

1. Press this button once.
2. Press button number " 1 ".
3. Press button number " 2 ".

Remote Control Transmitter Operation (for TV)

12. TV/AV Selection Button

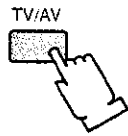

Press the button to select the TV mode, AV1 mode or AV2 mode.

The sequence is as below :

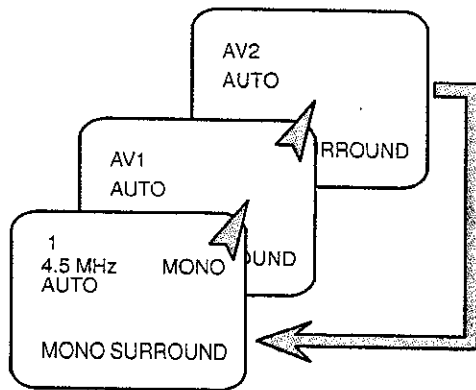

When TV mode is selected, the last Programme Number, Sound System, Colour System, Surround mode and Sound output (depending on type of broadcasting transmission) mode will appear.

When AV mode is selected, the last AV mode, Colour System and Surround mode will appear.

If the S-Video cable is connected to S-Video Terminal (for AV1 only), the selected AV mode, " S-Video " symbol (AV1 only) and Surround mode will appear on the screen.

e.g. S-Video cable is connected to S-Video terminal and AV1 is selected.

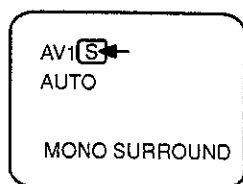

13. Sound Mute Button



Press the button to mute sound completely.

To cancel sound mute :

1. Press it again.
2. Press Volume Up " + " or Down " - " buttons.

14. Surround Button



By pressing this button, the surround effect can be changed. On-screen display as below :

1. TV mode

- a) If STEREO mode is activated.

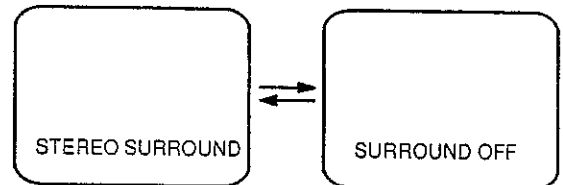

- b) If MONO mode is activated.

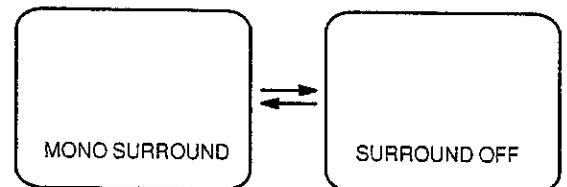

2. VIDEO mode

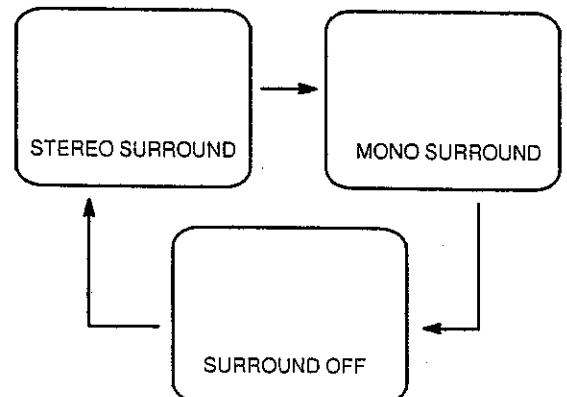

Remote Control Transmitter (for VCR)

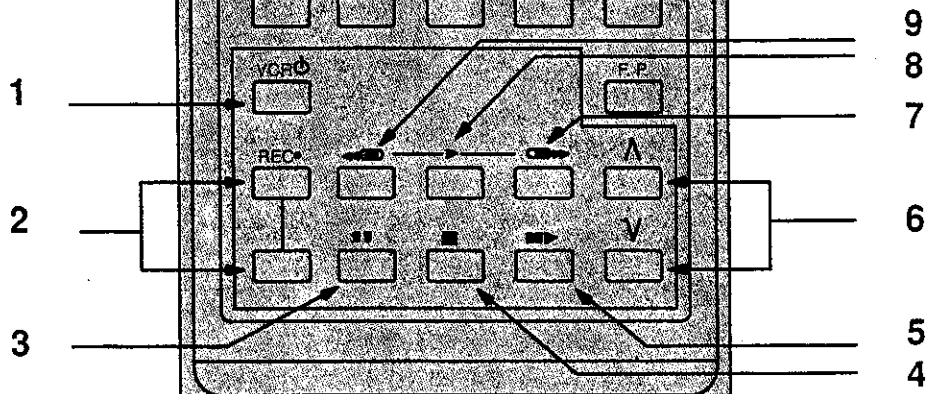
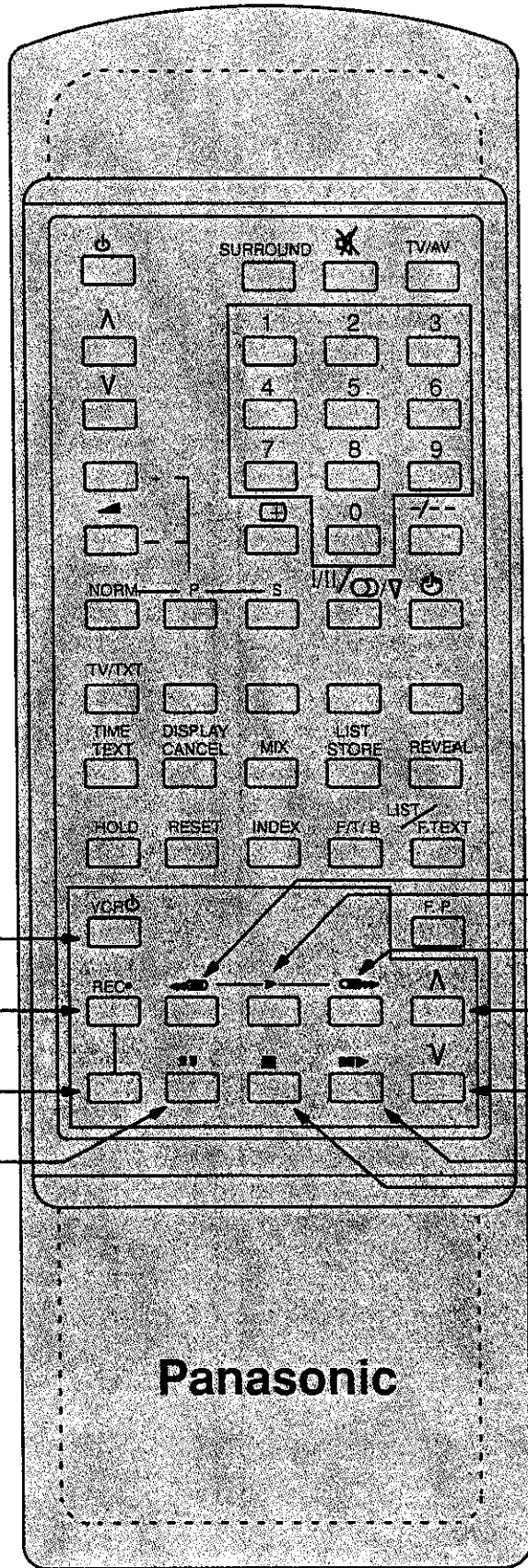

Panasonic

Remote Control Transmitter Operation (for VCR)

1. Power (Stand-by) Button



Press this button to switch the VCR to stand-by mode.
Press again to switch back on.

2. Rec (Record) Buttons

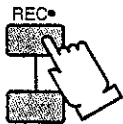

Press these buttons together to record.

3. Pause / Still Button

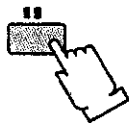

By pressing in playback mode, the tape will be stopped temporarily.
The picture will pause.

4. Stop Button

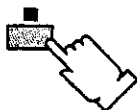

Press to stop the tape.

5. Still Advance Button

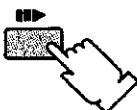

While PAUSE / STILL mode, press to advance the picture one frame at a time.

6. Programme Number Up or Down Buttons

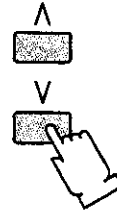

Press the Programme Number Up / Down buttons to increase or decrease the VCR program position to tune to a TV station.

7. Fast Forward Button



Press to fast forward the tape.
During the playback mode, press this button to view the picture in forward rapidly.

8. Play Button



Press to playback the tape.

9. Rewind / Review Button

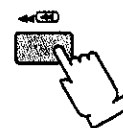

Press to rewind the tape.
During the playback mode, press this button to view the picture in reverse rapidly.

Remote Control Transmitter (for TELETEXT)

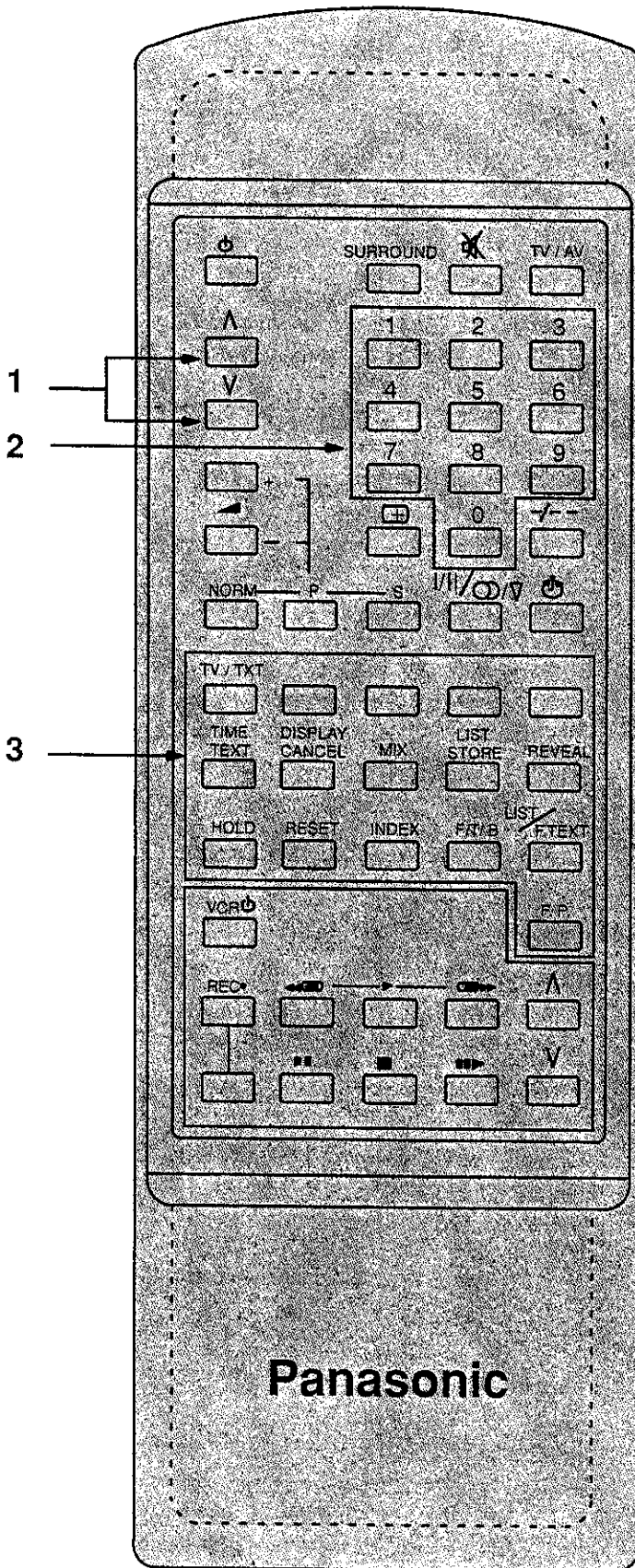

1. Programme Number Up or Down Buttons

2. Direct Programme Number Selection Buttons

3. Special Teletext Buttons

- TV/TXT Button
- Red Button
- Green Button
- Yellow Button
- Light Blue Button
- Time Text Button
- Display Cancel Button
- Mix Button
- List Store Button
- Reveal Button
- Hold Button
- Reset Button
- Index Button
- Full / Top / Bottom (F/T/B) Button
- List / F. Text Button
- Favourite Page Button

Panasonic

Remote Control Transmitter Operation (Teletext)

How to select TELETEXT mode.

Press ' TV/TXT ' button, **SELECT TEXT** will appear in a black bar to indicate TELETEXT availability.

On-screen appears as follows :

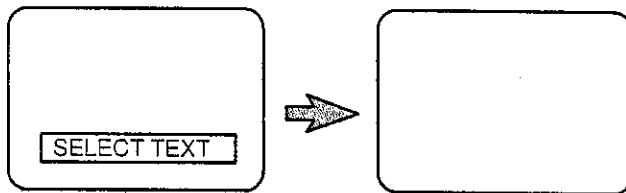

(after few seconds)

Note : A black bar briefly appears to indicate Teletext availability, when a channel is selected. If the station broadcasting Teletext has its own title transmitted in the Teletext signal for inclusion in this position, then this title will appear inside the black bar.

1. TV/TXT Button



Press this button to select the TELETEXT mode.
Press again to select the TV mode.

2. INDEX Button



Press this button to return to main index page.

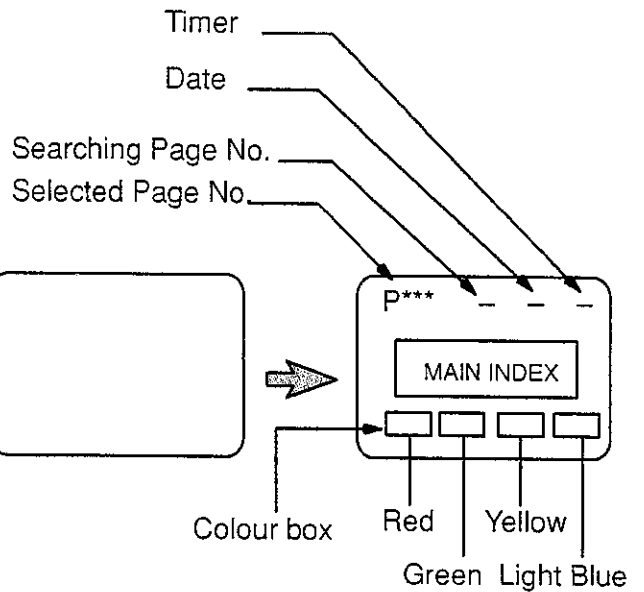

Each colour box has its own page number which can be stored by users. You can select the required page number by pressing one of these colour buttons on the remote control.

Note : The selected page number or current page number will be displayed on the top left of the screen.

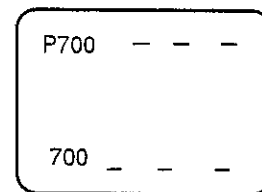

e.g. when a red colour button on the remote control is pressed, on-screen will change as follows :

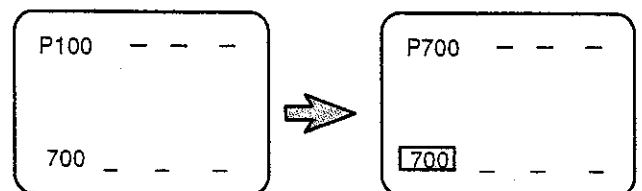

Remote Control Transmitter Operation (Teletext)

3. Direct Programme Number Selection Buttons (0~9).

The required page number can be displayed instantly by pressing these buttons continuously.

e.g. to select page number 800.

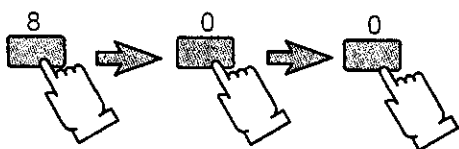

By pressing these buttons, the current page number will be changed to the selected page number.

The sequence is as follows :

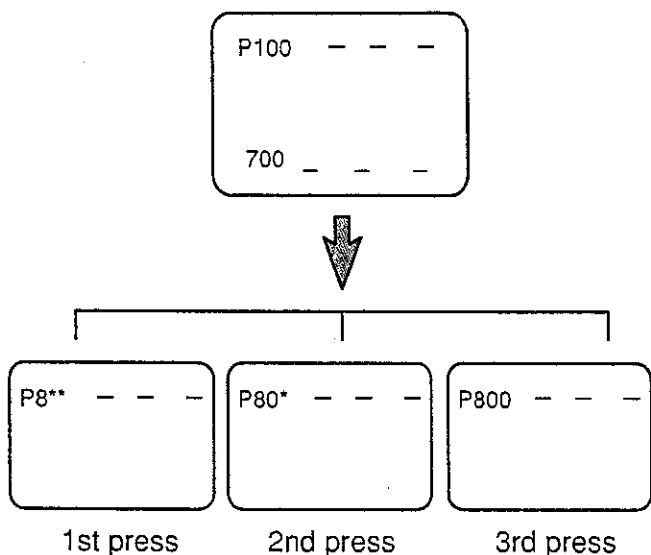

Note : All page numbers consist of 3 digits, the lowest being 100 and the highest being 899.

If the selected page is not available, the number will be blinking.

4. Programme Number Up / Down Buttons

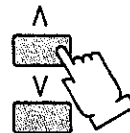

Press the button to select the next higher or lower teletext page.

5. FULL/TOP/BOTTOM (F/T/B) Button

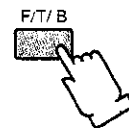

This button is used when characters on the screen are hard to read.

By pressing this button, the on-screen will change as below :

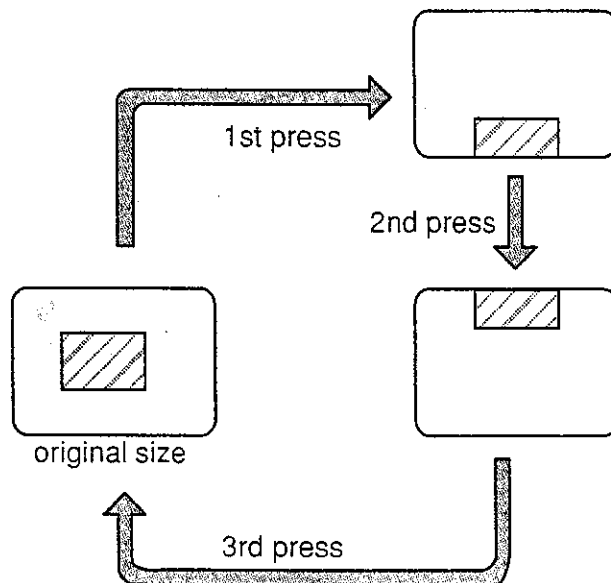

1st press – expands the upper half of the screen.
2nd press – expands the lower half of the screen.
3rd press – return it to the original size.

Remote Control Transmitter Operation (Teletext)

6. COLOUR Buttons

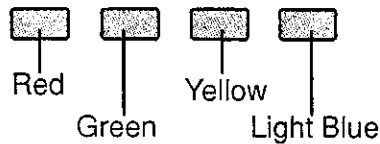

These buttons has own page number which will be displayed on the bottom of the screen. So that, the required page number can be displayed instantly by pressing one of these buttons.

e.g. Press a red colour button.

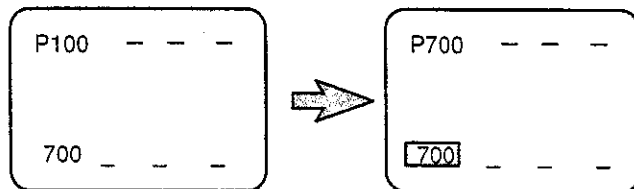

7. RESET Button



Pressing this button in the " F.TEST " mode reset the present page to page 100 and the associated colour subject.

Pressing this button in the " LIST " mode will reset the present page to the " RED " colour coded page number.

8. MIX Button



Teletext page and the TV programme can be shown at the same time by pressing this button.

Press the " TV/TXT " button to reverse back to the TV programme alone.

9. HOLD Button

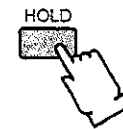

The selected teletext page may consist of a number of sub-pages. These sub-pages are rotated automatically, unless the ' hold ' has been activated.

Press this button to " hold " the sub-page.

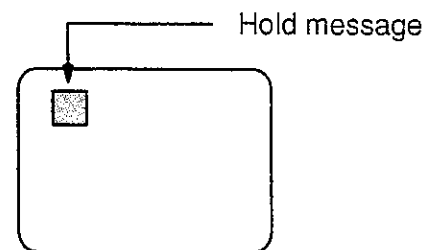

The character " Hold " will be displayed at the top left corner of the screen.

Press this button again to cancel the " Hold " command.

Remote Control Transmitter Operation (Teletext)

10. FAVOURITE PAGE (F.P.) Button

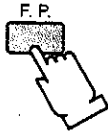

This function is used to store a favourite page in the TV memory and can be instantly recalled by pressing the button.

To store such a page the TV must be in LIST mode and the programme position must be from 0~16.

The processes can be done as follows :

1. Press the Light Blue button and choose your favourite page number.
2. Press LIST STORE button. The page number is now stored.

To recall this page (can be done on TV mode as well), press the F.P. button.

11. REVEAL Button



Some pages contain concealed information.

e.g. the solution to a riddle or a puzzle.

Press this button to reveal the information.
Press again to conceal the information.

12. DISPLAY CANCEL Button

(Teletext must be selected)

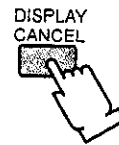

While a selected page is being searched for, the normal TV picture can be viewed by pressing this button.

When the page is found, the TEXT message appear on the top left corner of the screen. Press the "TV/TXT" button to display the selected page.

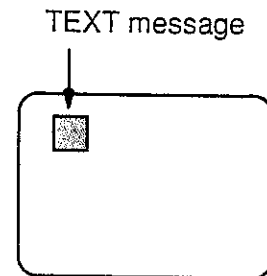

How to watch a newflash page.

1. Select a newflash page in Text mode.

e.g. Page 300

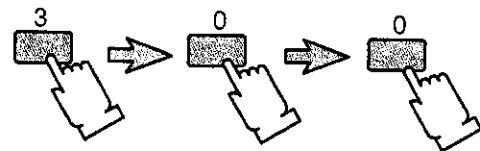

2. Press the " Display Cancel " button.
The TV is switched from the Teletext page to TV broadcast.

Every time an update newflash information is available, the newflash information will be displayed at the bottom of the screen.



3. Press the " TV/TXT " button twice.

Remote Control Transmitter Operation (Teletext)

Fast Text (F. TEXT) Mode Access

In " F. TEXT " mode, select the desired teletext information by pressing one of the colour buttons on the remote control which correspond with the coloured subject title on the screen.

(Teletext must be selected)

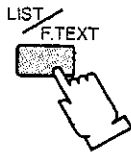

1. Press this button to select the " F. TEXT " The on-screen display is as follows :

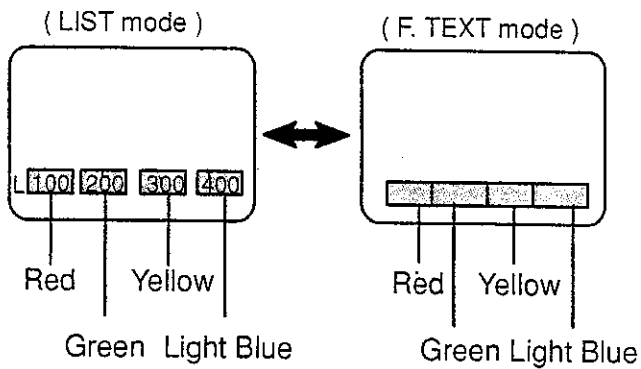

e.g. The on-screen displays the subject titles.

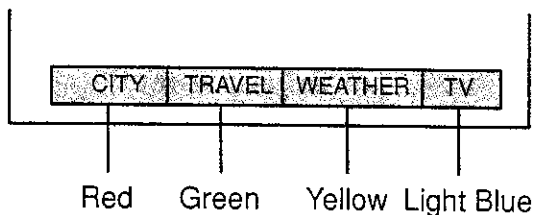

2. When one of these buttons is pressed, the subject titles page will be displayed.
e.g. By pressing the Light Blue colour button on the remote control the TV page will be viewed.
3. Follow the same procedure to access other colour-coded information pages.

Note :

1. Subject titles and their sequence for access are set-up by TV broadcast stations, they are not user definable with the Remote Control.
2. It is a convenient way of accessing some Teletext pages without to entering page number.

Remote Control Transmitter Operation (Teletext)

TEXT ALARM Page Access

This function is used for selected pages only.
e.g. The Teletext ALARM page (Refer to the subject index page for page location).

(Teletext must be selected first)



Select the text ALARM page.
Press the TIME TEXT button.

By pressing the button, this indicator (T***) appears. It means you can enter the time at which this alarm page should be displayed using direct programme number selection buttons (0 ~ 9) on the remote control.

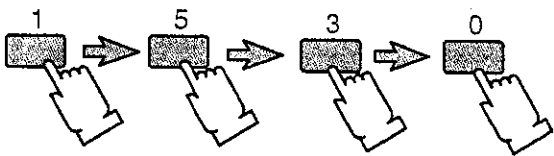
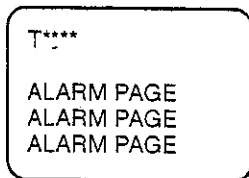

This feature uses a 24 hour clock.

To set the alarm for 3 : 30 p.m., press numerical buttons 1, 5, 3, 0 consecutively on the remote control (as shown above). The indicator which displayed on the top corner of the screen will change to " T1530 " momentarily, then return to the current page number.

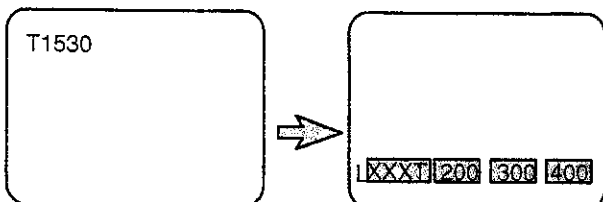

In " LIST " mode the letter " T " will appear in the current coloured box at the bottom of the screen indicating that the alarm page has been set.

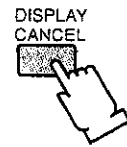

Press the DISPLAY CANCEL button to view TV broadcast.

At 15 : 30 the alarm page will be displayed.

How to cancel this feature.



1. Press the " TV/TXT " button to return to normal viewing.

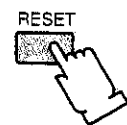

2. Press the " RESET " button to select other teletext page.

Remote Control Transmitter Operation (Teletext)

List Mode Page Memory Allocation

List mode is a convenient way of accessing some teletext pages without the need to enter page numbers. In this mode, 4 page numbers can be preset for each Programme Number from 0 to 16. A maximum of 68 pages can be programmed. Any one of these 4 pages can be displayed instantly by pressing the corresponding " colour " Button on the Remote Control.

(Teletext must be selected)

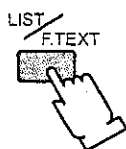

1. Press this button to select the " LIST " mode. Press again to get F. TEXT mode.

The on-screen display is as follows:

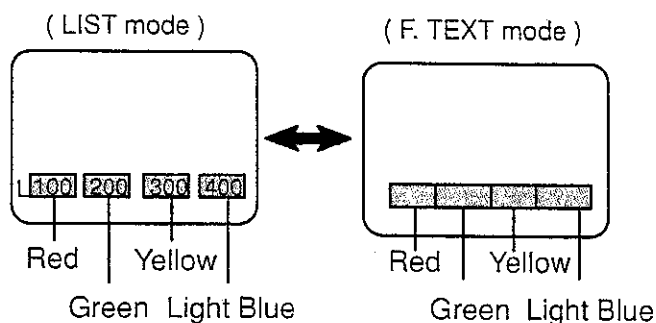

2. To select the memory position, press one of these colour buttons.

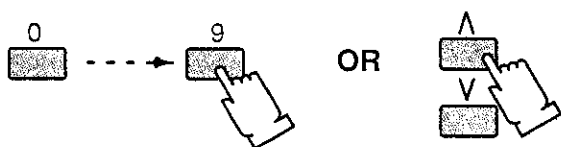

3. Enter the desired text page number by pressing numerical buttons (0 ~ 9) or Page Number Up / Down buttons on the remote control.

4. Repeat step 2 and 3 for the remaining positions if required.

Up to 4 page numbers can be preset for each programme position from 0 to 16.



5. To store these page numbers into memories, press this button and hold it until the background of the 4 numbers change to white.

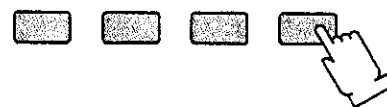

6. Every time a " LIST " mode is selected, these 4 page numbers will flash until all 4 pages have been found and stored into memories.

Any one of these 4 pages can be displayed instantly by pressing the colour buttons on the remote control.

Note :

1. If a new page number is entered for viewing, it will not replace the previous number in the memory at that position unless the " LIST STORE " button is pressed and held down for a few seconds. The 4 page numbers will be reset to the preset numbers when either the "RESET" button is pressed or programme position is changed, or mode changes between " F.TEXT " and LIST MODE, or TV set is turned off.
2. The 4 preset page numbers can be changed when required, by following procedure 2 to 5 above.
3. Page numbers preset can only be performed on programme number from 0 to 16.

Remote Control Transmitter Operation (Teletext)

Text Sub Page Access

When a Teletext Information Page exceeds more than one screen of information, it may take some time for automatic changing of the sub-pages to reach the sub -pages as required. It is possible to enter the required sub-page and continue watching the normal programme until the correct sub-page is found.

(Teletext must be selected first).

The Required Teletext page must be selected.



When the button is pressed, this indicator "T****" will be displayed on the top left of the screen.

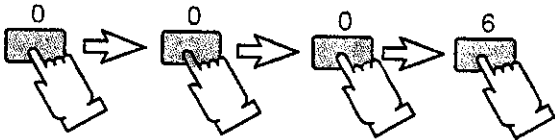

Enter the desired sub-page number while the "T****" prompt is on the screen.

Note :

As shown above sub-page selection must be inserted as a 4 Digit Number.

i.e. for sub-page 6, press the buttons "0-0-0-6" continuously.

The screen will change as shown :

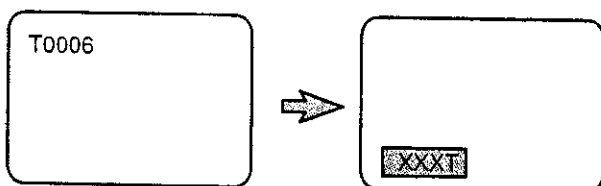

In "LIST" mode the letter "T" will appear in the current coloured box at the bottom left side of the screen. This is an indication that the sub-code has been set.

Note :

If no sub-page exists for the page for which this function has been set, the system will wait indefinitely until it has been cancelled.

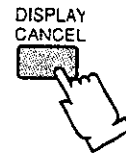

Press this button to view the normal TV mode.

When the desired sub-page is received, the "TEXT" message appears on the top left of the screen.

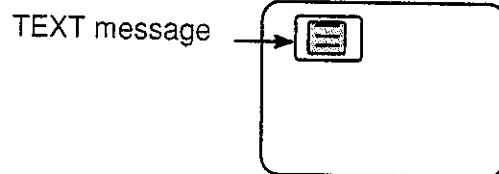

Press the TV / TEXT twice to display the received sub-page.

To clear the sub-coded page, enter a new page number or press the "RESET" button.

Note :

It is not possible to select another Programme Number during sub-page operation, without cancelling the sub-page search operation.

How to connect an External Antenna

To obtain the best quality picture and sound, an external antenna, the correct cables (75 Ohm coaxial) and the correct terminating plug will be required.

If a communal antenna system is used, you may require the correct connection cable and plugs between the wall antenna socket and your television receiver.

Your local Television Service Dealer may be able to assist you in obtaining the correct antenna system for your particular area and accessories required.

Any matters about antenna installation, upgrading of existing systems or accessories required, and the cost incurred, are the responsibility of the customer.

Note :

If your existing antenna system uses 300 Ohm to 75 Ohm Balun, see Below.

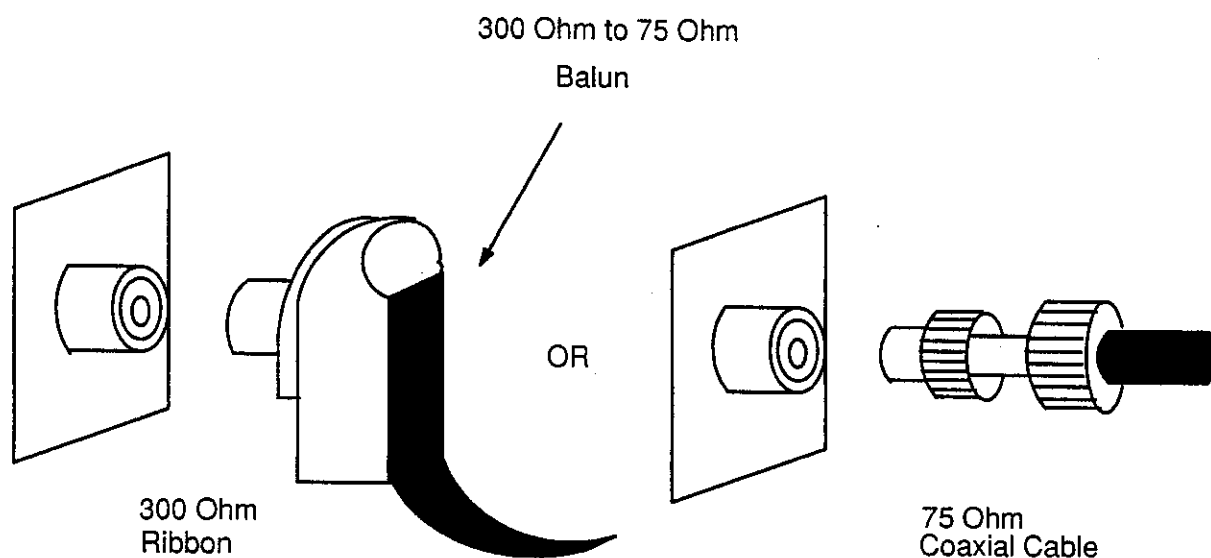

Connections (Audio and Video Terminals)

Connect the AV1 and AV2 (AUDIO and VIDEO Terminals) on the TV set with playback equipments as follows :

e.g. To connect the AV1 with playback equipments.

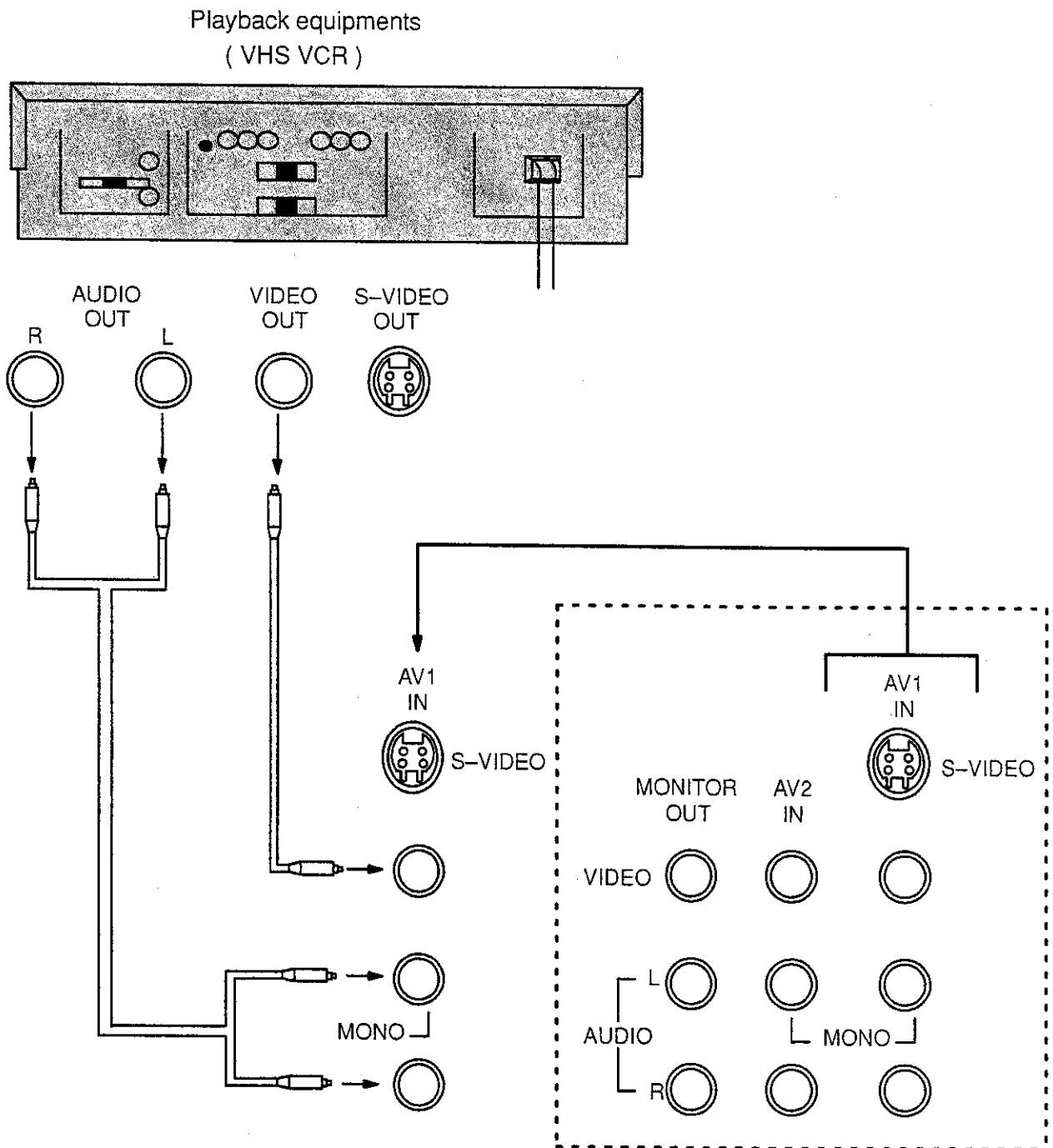

Connections (Audio and S-Video Terminals)

Connect the AV1 (AUDIO and S-VIDEO Terminals) on the TV set with playback equipments as follows :

e.g. To connect the AV1 with S VHS VCR.

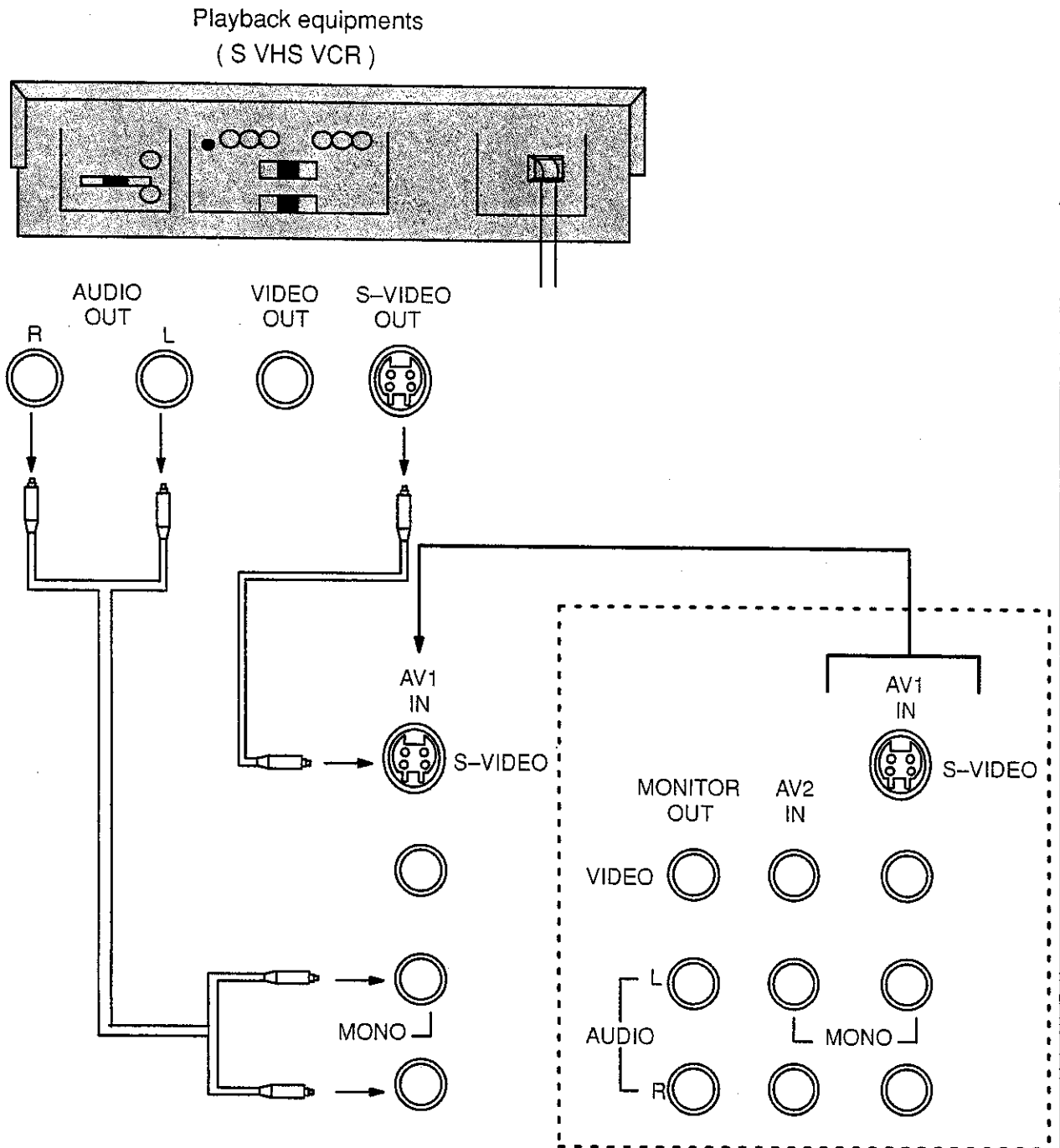

Connections (Audio, Video and S-Video Terminals)



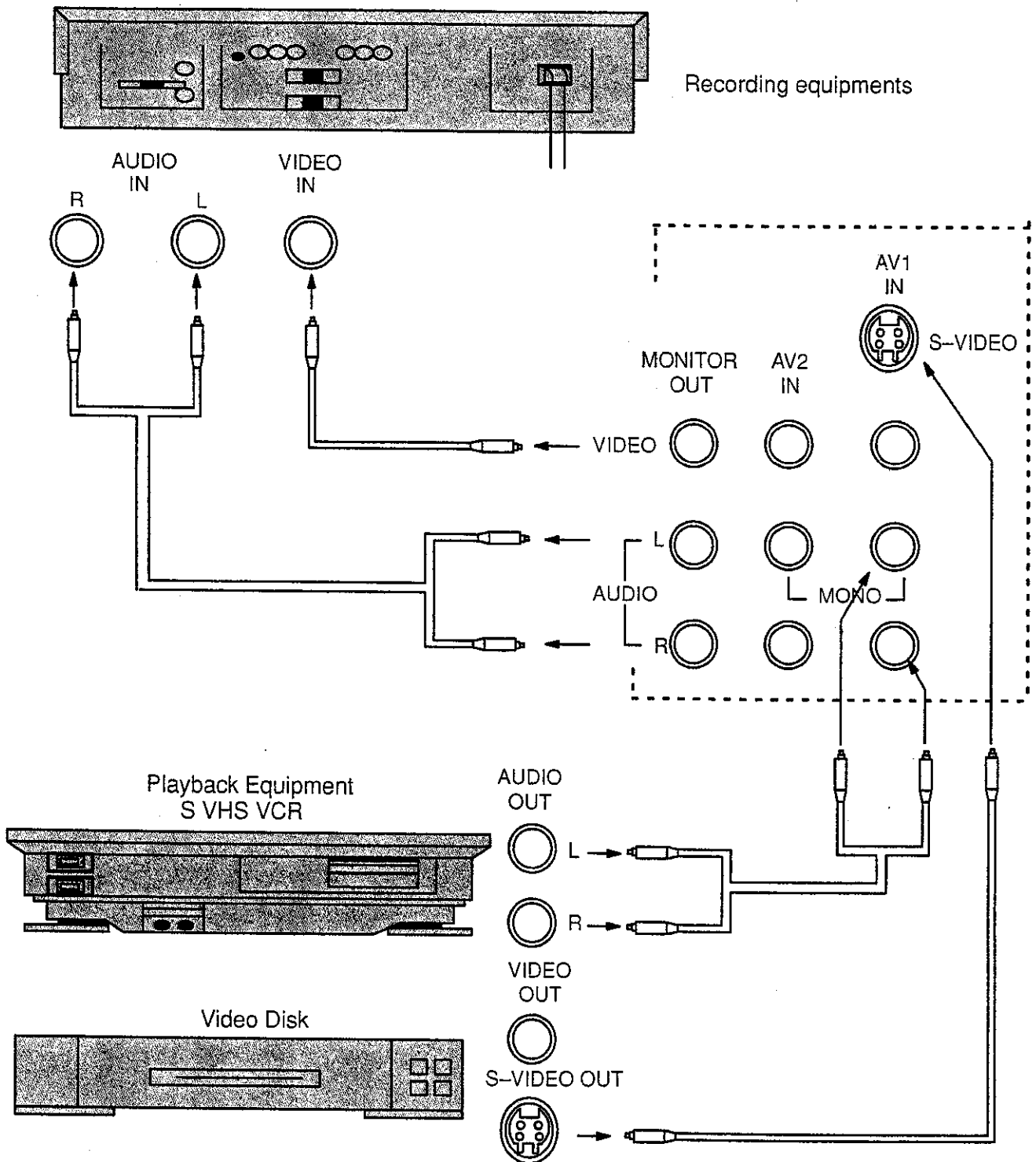

















Connect the AUDIO, VIDEO and S-VIDEO (e.g. via AV1 Terminal) as follows :



1. Never connect the same video recorder with both the VIDEO IN and VIDEO OUT terminals on the TV set, as this could cause incorrect operation.
2. " MONITOR OUT " terminals contain signal which are on the TV screen at that time, e.g. TV programmes or signal from AV2 input.

Troubleshooting

Before calling for service, determine the symptoms and make a few simple checks as shown below.

Symptoms		Checks
Picture	Sound	
 <p>Snowy Picture</p>	 <p>Noisy Sound</p>	<p>Aerial Location, direction Connection</p>
 <p>Multiple image</p>	 <p>Normal Sound</p>	<p>Aerial Location, direction Connection</p>
 <p>Interference</p>	 <p>Noisy Sound</p>	<p>Electrical Appliances Cars / Motorcycles Fluorescent Lamps</p>
 <p>Normal Picture</p>	 <p>No Sound</p>	<p>Volume (Check whether the mute function has been activated on the Remote Control.)</p>
 <p>No Picture</p>	 <p>No Sound</p>	<p>Not plugged into AC outlet Not switched on Contrast and Brightness / Volume Setting (Check by pushing the Power Switch or Stand-by Button on the Remote Control.)</p>
 <p>No Colour</p>	 <p>Normal Sound</p>	<p>Colour Control</p>
 <p>Scrambled</p>	 <p>Normal or Weak Sound</p>	<p>Re-tune Channels</p>
 <p>Colour Patches</p>	 <p>Normal Sound</p>	<p>Magnetic interference from unshielded equipment. Receiver moved while "ON".</p>
 <p>No Colour</p>  <p>Rolling Picture</p>  <p>H-Line</p>	 <p>Noisy Sound</p>	<p>System Button</p>

Specifications

Power Source

AC Auto 110 ~ 240 V, 50 / 60 Hz

Power Consumption

146 W,
5 W (Stand-by Condition)

Receiving System

System	Function
PAL B,G PAL I PAL D NTSC M	Reception of broadcasts and Playback from Video Tape Recorders
NTSC 4.43 / 5.5MHz NTSC 4.43 / 6.0MHz NTSC 4.43 / 6.5MHz NTSC 3.58 / 5.5MHz NTSC 3.58 / 6.0MHz NTSC 3.58 / 6.5MHz	Playback from VideoTape Recorders
PAL 60Hz / 5.5MHz PAL 60Hz / 6.0MHz PAL 60Hz / 6.5MHz	Playback from Disc Players

Receiving Channels

Regular TV	VHF BAND 2 - 12 1 - 12 1 - 11 1 - 12 2 - 13	PAL B, G PAL D PAL B NTSC M Japan NTSC M U.S.A
	UHF BAND 21 - 69 28 - 69 13 - 56 13 - 62 14 - 69	PAL B,G I PAL G (Australia) PAL D NTSC M Japan NTSC M U.S.A.
	CATV	S1-S20

Specifications

Picture Tube

62 cm (25 inches) for TX-21GF10M
59 cm (25 inches) for TX-21GF10Z
Measured diagonally, 100° deflection.

Audio Output

5 W x 2

Aerial Impedance

75 Ω Unbalanced coaxial

Video / Audio Terminals

AV In	Video In	1 V _{p-p} . 75Ω
	Audio In	Approx. 400mV _{rms}
TV Out	Video Out	1 V _{p-p} . 75Ω
	Audio Out	Approx. 400mV _{rms}

Dimensions (W x D x H)

606 x 488 x 506 mm

Weight

29.50 Kg

Note :

Design and Specifications are subject to change without notice.
Weight and Dimensions shown are approximate.

General Information

1. If the set is not switched off when the TV stations stop transmitting at the end of the evening, it will automatically go to stand-by mode after 5 minutes, only in Auto shut-off mode. This function will not operate when the TV is in AV mode.
2. Before calling for service, please refer to the troubleshooting guide on page 30 to determine the symptoms.
3. VCR Mode Select Switch is located on the rear side of the remote control. Please set to " A " when using National/Panasonic VCR. If operation cannot be carried out, set to " B ".

Matsushita Electric Industrial Co., Sdn. Bhd.
Central P.O. Box 288, Osaka 530-91, Japan.