



# Panasonic<sup>®</sup>

## Operating Instructions LCD TV

---

Model No. **TX-20LA2M**  
**TX-20LA2A**  
**TX-20LA2X**



The illustration shown is an image.

Please read these instructions before operating your set and retain them for future reference.

**English**

TQBC0857-1

# Dear Panasonic Customer

Welcome to the Panasonic family of customers. We hope that you will have many years of enjoyment from your new LCD TV.

To obtain maximum benefit from your set, please read these Instructions before making any adjustments, and retain them for future reference.

Retain your purchase receipt also, and note down the model number and serial number of your set in the space provided on the back cover of these instructions.

## Contents

Accessories .....	2	Auto tuning .....	14
Warnings and Precautions .....	3	Auto tuning (via top panel) .....	14
Fitting remote control batteries .....	5	Manual tuning .....	15
How to use the LCD stand .....	5	Manual tuning (via top panel) .....	15
Antenna connection .....	6	Channel Allocation .....	16
Audio / Video connections .....	7	Picture menu .....	17
How to connect the Headphones terminal .....	7	Sound menu .....	18
How to connect the Monitor Output terminals to other Equipment .....	8	Setup menu .....	19
How to connect the AV1 Input terminals .....	8	Aspect Controls .....	20
How to connect the DVD Input terminals .....	9	Still .....	20
Power On / Off .....	9	Teletext operation .....	21
Basic controls: top panel and remote control .....	10	VCR / DVD operation .....	24
Using the On Screen Displays .....	11	Stereo / Bilingual Sound Selection .....	24
Language .....	11	Remote control setting .....	25
Tuning .....	12	Troubleshooting .....	26
Tuning menu .....	12	Maintenance .....	26
Channel Selection .....	13	Specifications .....	27

## Accessories

Check that you have the accessories and items shown

Operating Instruction book

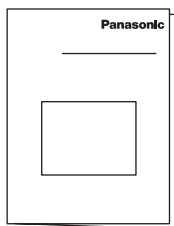

Remote Control Transmitter (N2QAJB000121)



Batteries for the Remote Control Transmitter (2 × R6 (AA) size)



AC Plug Adaptor TX-20LA2X only

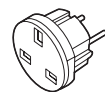

## Warnings and Precautions

- This TV set is designed to operate on AC 110-240 V, 50 / 60 Hz.

- To prevent damage which might result in electric shock or fire, do not expose this TV set to rain or excessive moisture. This TV must not be exposed to dripping or splashing water, and objects filled with liquid, such as vases, must not be placed on top of or above the TV.



- DO NOT use this unit near water. (Near a bath tub, etc.)

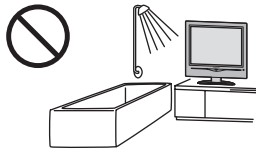

- Unplug the power cord in the event of any malfunction (screen goes blank, no sound, odd sounds, smoke or unusual odours coming from the unit). Unplug the power cord if foreign matter or water falls into the unit, or if the unit is dropped or the cabinet is damaged.

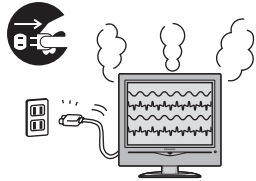

- TAKE CARE NOT to damage the power cord.

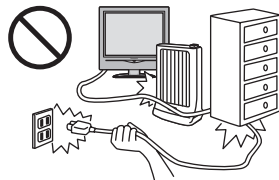

- DO NOT touch the aerial cable and this unit when there is lightning.

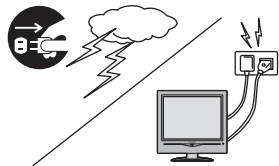

- DO NOT use if the power cord or power plug is damaged, or if the plug does not fit tightly into the socket.

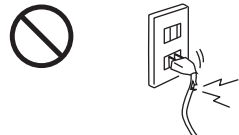

- DO NOT use at a voltage other than indicated.



- DO NOT touch the power plug if your hands are wet.



- Turn the power "Off" before connecting other electrical equipment.



- Ask your sales outlet to install the aerial.

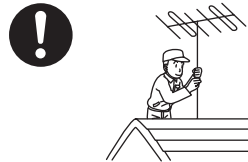

### • WARNING : HIGH VOLTAGE!!!

- Do not remove the rear cover as live parts are accessible when it is removed. There are no user serviceable parts inside.



### • TV Games / Home Computers

Extended use of TV games or home computers with any television set can cause a permanent 'shadow' on the screen. This type of irreversible LCD panel damage, can be limited by observing the following points:

- Reduce the brightness and contrast levels to a minimum viewing level.
- Do not allow a still picture to be displayed for an extended period, as this can cause a permanent after-image to remain on the LCD TV screen.
- Examples of still pictures include logos, video games, computer images, teletext and images displayed in 16:9 mode.
- This type of LCD panel damage, is not an operating defect, and as such is not covered by the Panasonic warranty.

## Warnings and Precautions

- The On / Off switch on this model does not fully disconnect the TV from the mains supply.

Remove the mains plug from the wall socket before connecting or disconnecting any leads, or if the TV set is not used for a prolonged period of time.

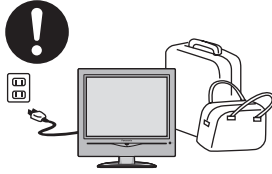

### Note:

If the set is not switched off when the TV station stops transmitting, it will automatically go to Standby mode after 30 minutes. This function will not operate when the TV is in AV mode.

### Cabinet and LCD panel care

Remove the mains plug from the wall socket. The cabinet and LCD panel can be cleaned with a soft cloth moistened with mild detergent and water. Do not use solutions containing benzol or petroleum.



- When ambient temperature is cool, the picture may take a short time to reach normal brightness, but this is not a malfunction. (After brief moment, the picture will have normal brightness.)

- Adequate ventilation is essential to prevent failure of electrical components, we recommend that a gap of at least 10cm is left all around this TV set even when it is placed inside a cabinet or between shelves.

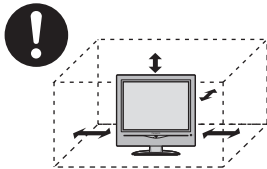

- Avoid exposing the TV set to direct sunlight and other sources of heat. To prevent fire, never place any type of candle or naked flame on top or near the TV set.

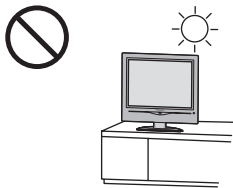

- DO NOT insert foreign objects (metal or easily flammable objects).



- DO NOT stand, or place heavy objects on the unit. Particular care should be taken by families with small children.

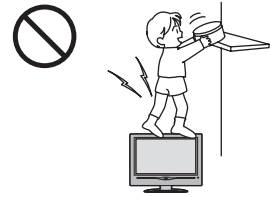

- DO NOT place in an unstable location.



- Place in a safe location.



- DO NOT jolt the unit.



### Preparation

#### Receiver Location

Locate for comfortable viewing. Avoid placing where sunlight or other bright light (including reflections) will fall on the screen.

Use of some types of fluorescent lighting can reduce remote control transmitter range.

Adequate ventilation is essential to prevent internal component failure. Keep away from areas of excessive heat or moisture.

To insure optimum picture do not position magnetic equipment (motors, fans, other speakers, etc.) nearby.

#### Optional External Equipment

The Audio / Video connection between components can be made with shielded video and audio cables. For best performance, we recommend 75  $\Omega$  coaxial aerial cable is used. Cables are available from your dealer or electronic supply store.

Before you purchase any cables, be sure you know what type of output and input connectors your various components require. Also determine the length of cable you will need.

#### For optimum quality picture

When the LCD is exposed to light from outdoors or lighting fixtures, high-contrast pictures may not be displayed clearly. Turn off florescent lamps near the LCD and place in a location not exposed to outdoor light.

## Fitting remote control batteries

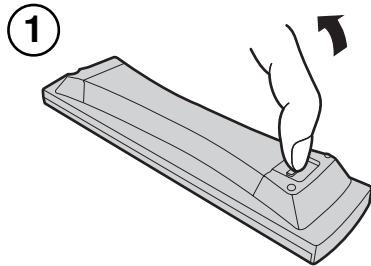

Pull and hold the hook, then open the battery cover.

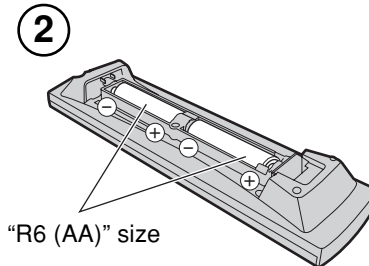

Insert batteries - note correct polarity (+ and -).

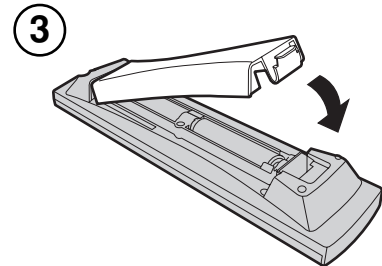

Replace the cover.

Do not use rechargeable (Ni-Cad) batteries. They are different in shape and performance and may fail to ensure correct operation.

### Battery cautions

The incorrect use of batteries can cause electrolyte leakage which will corrode the Remote Control or cause the batteries to burst.

#### Observe the following precaution:

1. Batteries shall always be replaced as a pair. Always use new batteries when replacing the old set.
2. Do not combine a used battery with a new one.
3. Do not mix battery types (example: "Zinc Carbon" with "Alkaline").
4. Do not attempt to charge, short-circuit, disassemble, heat or burn used batteries.
5. Battery replacement is necessary when remote control acts sporadically or stops operating the TV set.

## How to use the LCD stand

Adjust the LCD panel to your desired angle.  
The LCD panel can be adjusted the following direction:

- 5° Forward
- 15° Backward
- 30° Right
- 30° Left

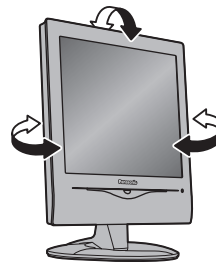

(View from the side)

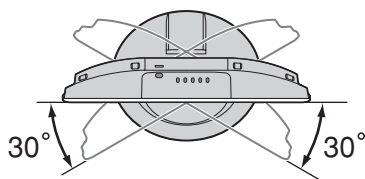

(View from the top)

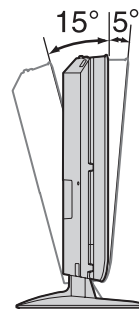

## Antenna connection

For proper reception of VHF / UHF channels, an external antenna is required. For best reception, an outdoor antenna is recommended.

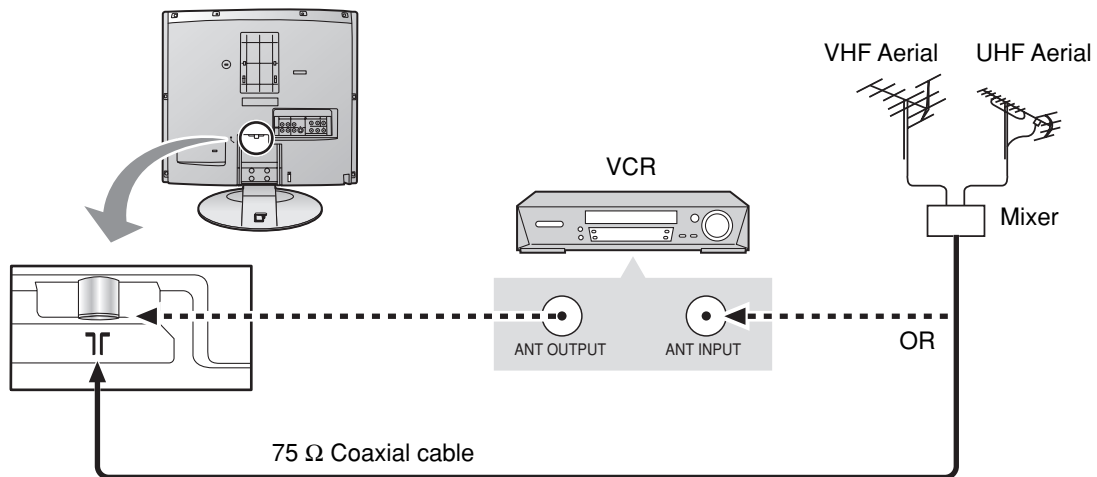

### Notes:

- Additional equipment, cables and adapter plugs shown are not supplied with this TV set.
- To obtain optimum quality picture and sound, an Aerial, the correct cable (75 Ω coaxial) and the correct terminating plug are required.
- If a communal Aerial system is used, you may require the correct connection cable and plug between the wall Aerial socket and your TV.
- Your local Television Service Centre or Dealer may be able to assist you in obtaining the correct Aerial system for your particular area and the accessories required.
- Any matters regarding Aerial installation, upgrading of existing systems or accessories required, and the costs incurred, are the responsibility of you, the Customer.

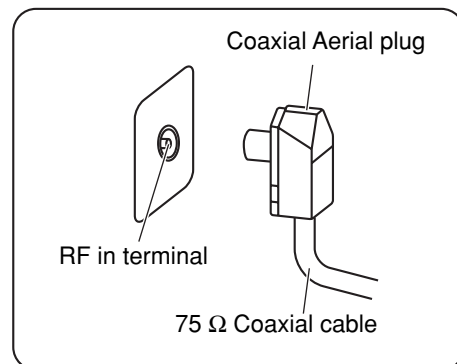

## Audio / Video connections

It is possible to connect a variety of additional equipment to this TV. The following pages detail how to connect external equipment to the front and rear of the TV.

Once your equipment is connected, use the following procedure to view the input:

Press the **TV/AV** button.

Whilst the on screen selector keys are displayed, press coloured buttons to select the AV source you wish to view.

**Red** button : AV1

**Green** button : AV2

The on screen selector keys that appear clear after a few seconds. If you want to select an input when the keys are not shown, press any coloured button and the keys will reappear.

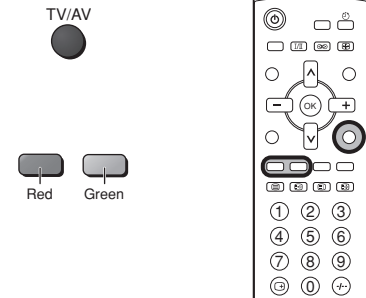

### Notes:

- You can also select an AV source using the **TV/AV** button on the top panel of the TV.  
Press the **TV/AV** button repeatedly until you reach the AV source you wish to view.
- When a Monaural VCR is used, connect the Monaural Audio cable to the AUDIO L terminal.
- Additional equipment and cables shown are not supplied with this TV set.

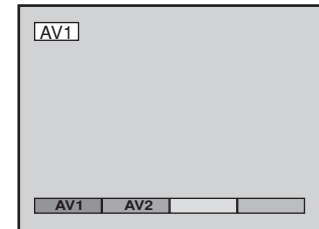

## How to connect the Headphones terminal

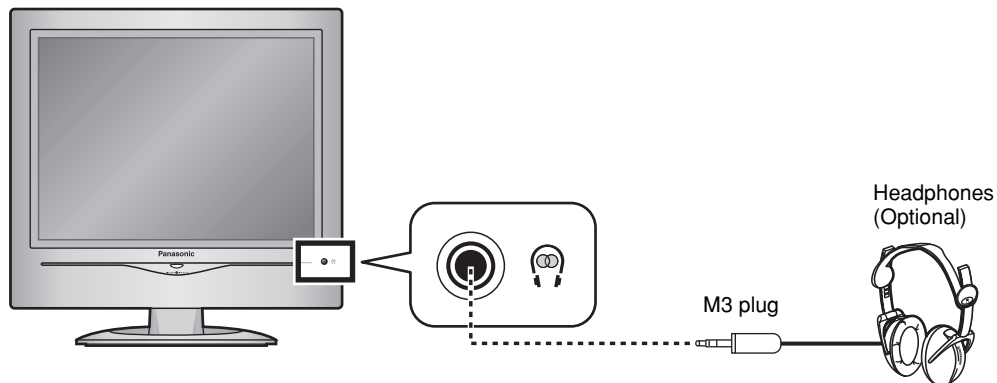

### Note:

The volume level of the headphones can be adjusted by selecting "Volume" from the Sound menu.

# Audio / Video connections

**To bundle the cables with the clamber**

1. Pull upward.
2. Put the cables and close.

**Note:**  
Do not put the antenna cable and the power cord together to avoid noise.

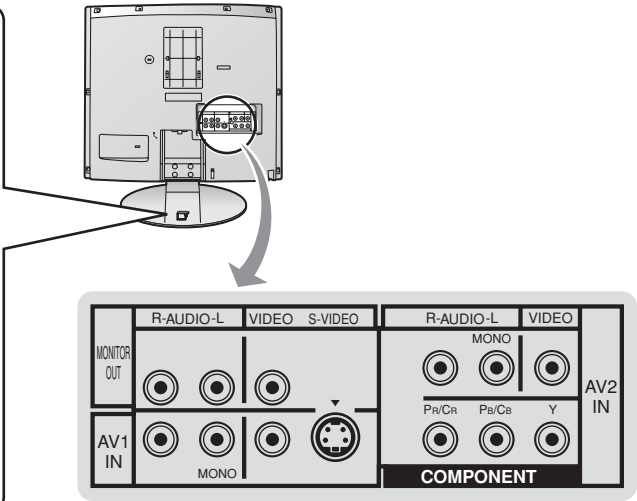

## How to connect the Monitor Output terminals to other Equipment

Example of output signal source

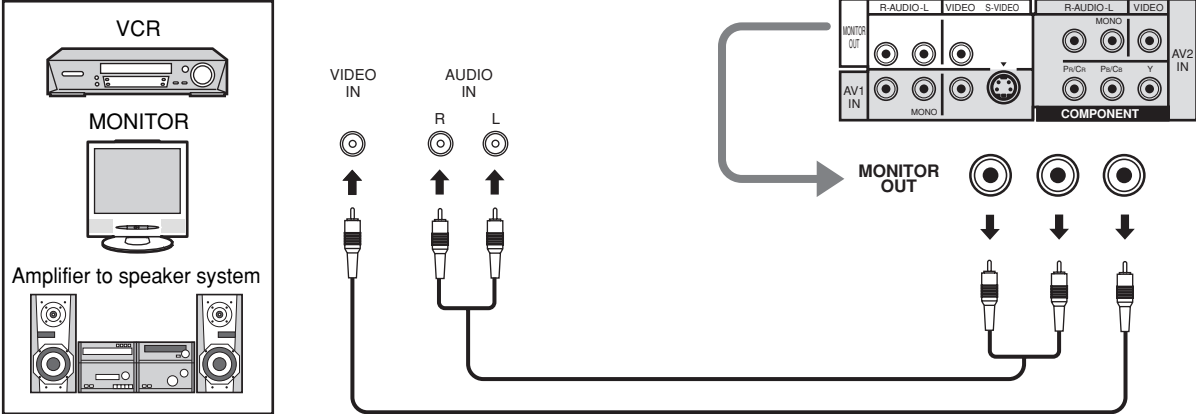

## How to connect the AV1 Input terminals

Example of input signal source

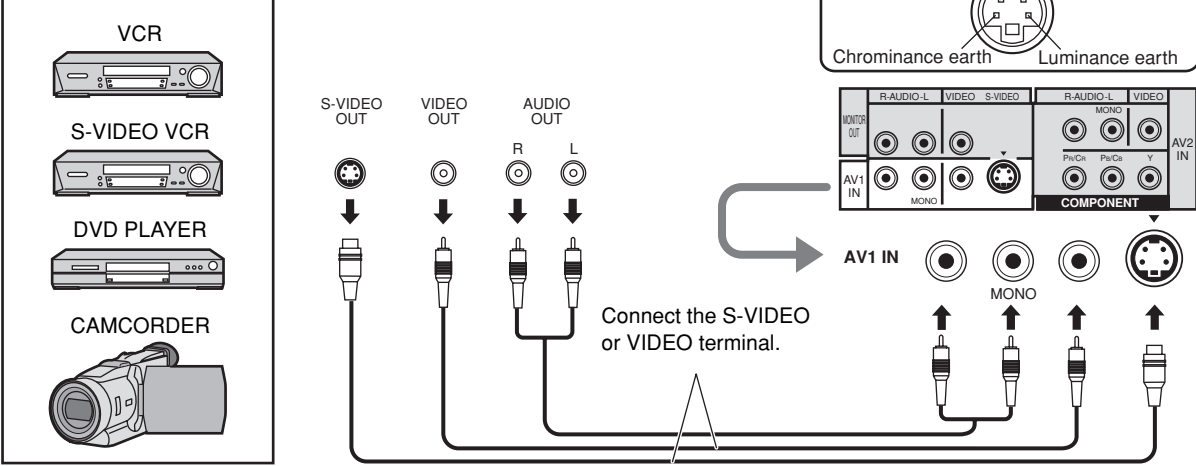



# Audio / Video connections

## How to connect the DVD Input terminals

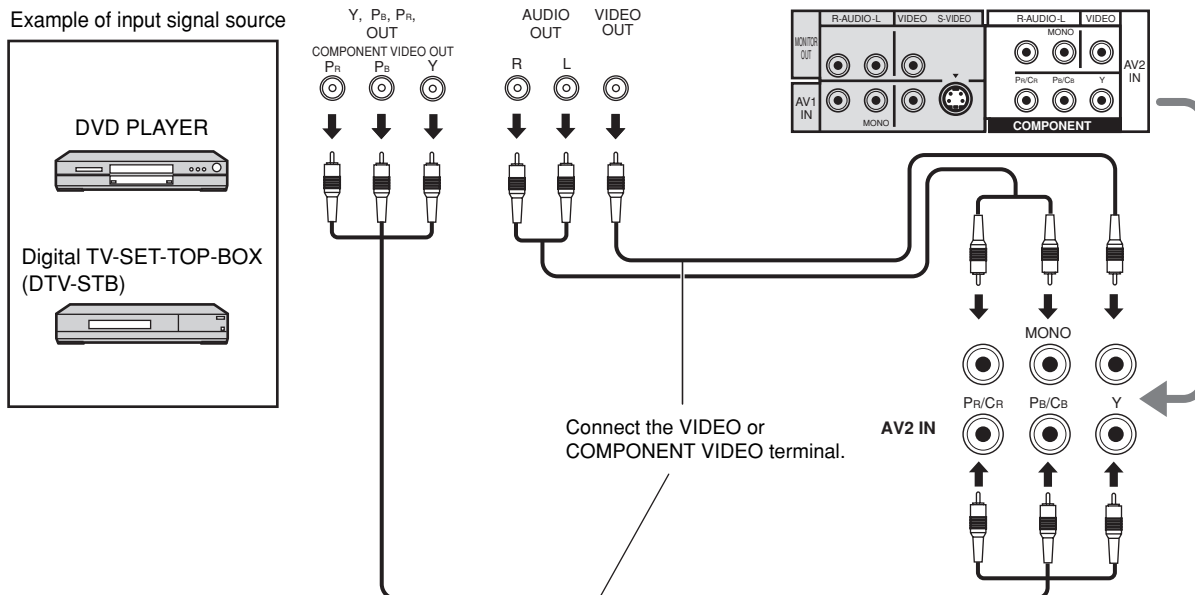

**Note:**  
Component input terminals are used for 525i or 625i signal.

# Power On / Off

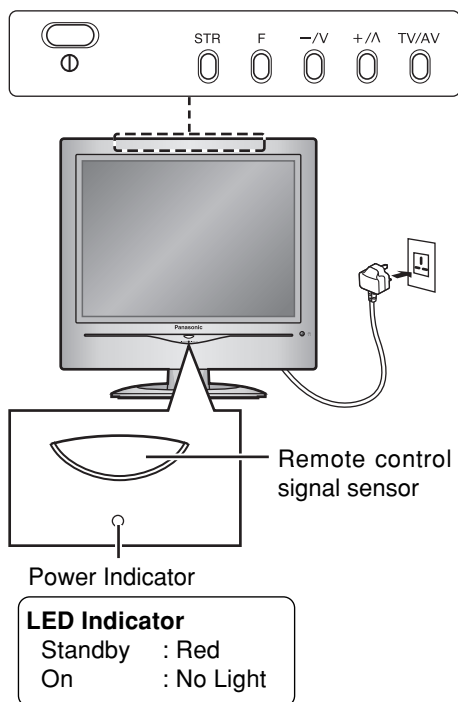

**Connect the mains plug to the wall socket.**

Press the switch on the TV set to turn the set on.

To switch the TV set to Standby mode, press the button on the remote control. The TV set can be switched on by pressing the button again if it was in Standby mode.

**Notes:**

- This TV will still consume some power as long as the mains plug is still inserted into the wall socket.
- The mains plug shown is an example.

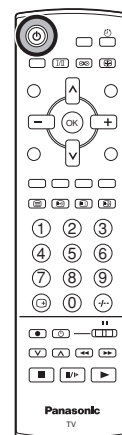

# Basic controls: top panel and remote control

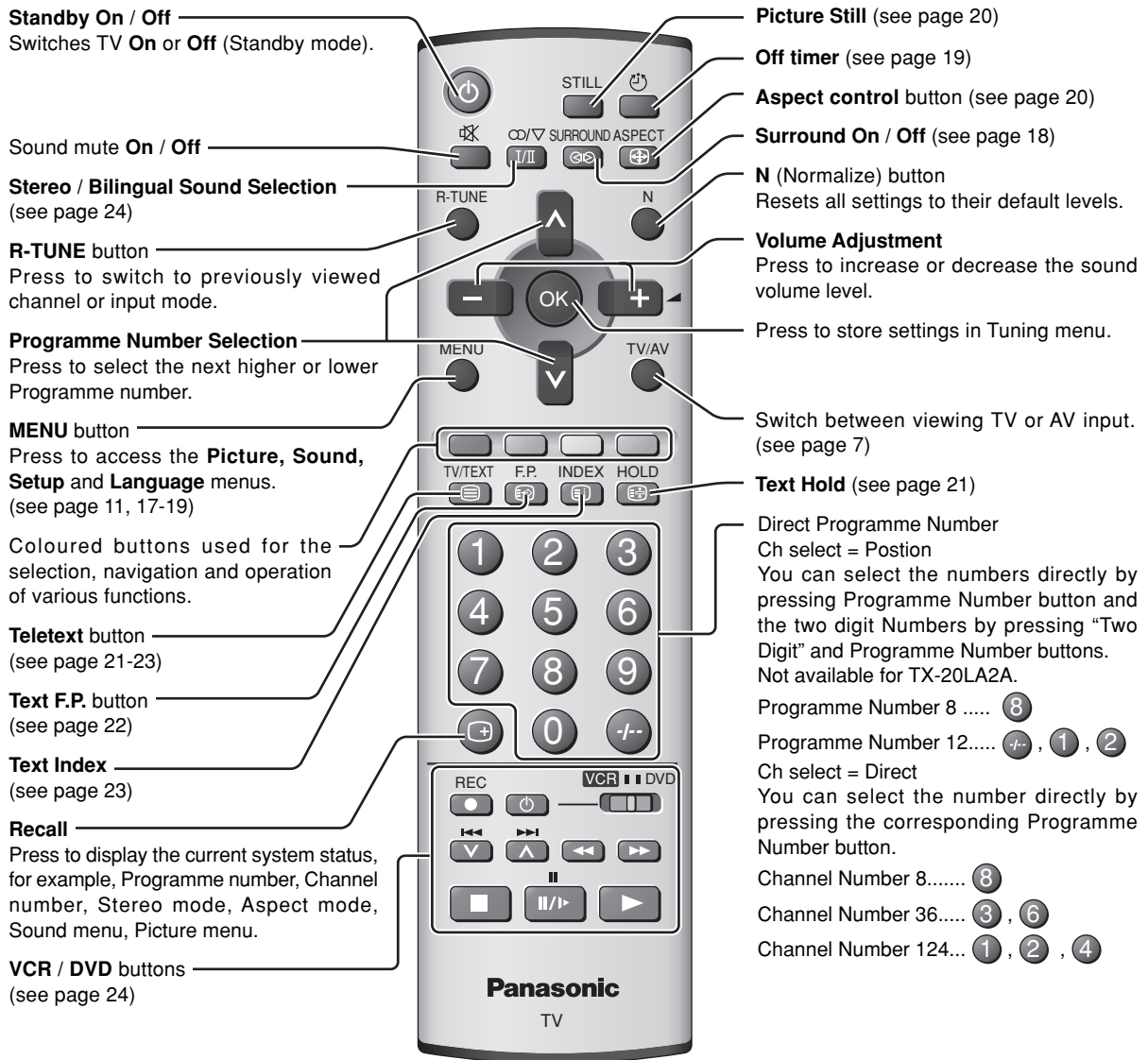
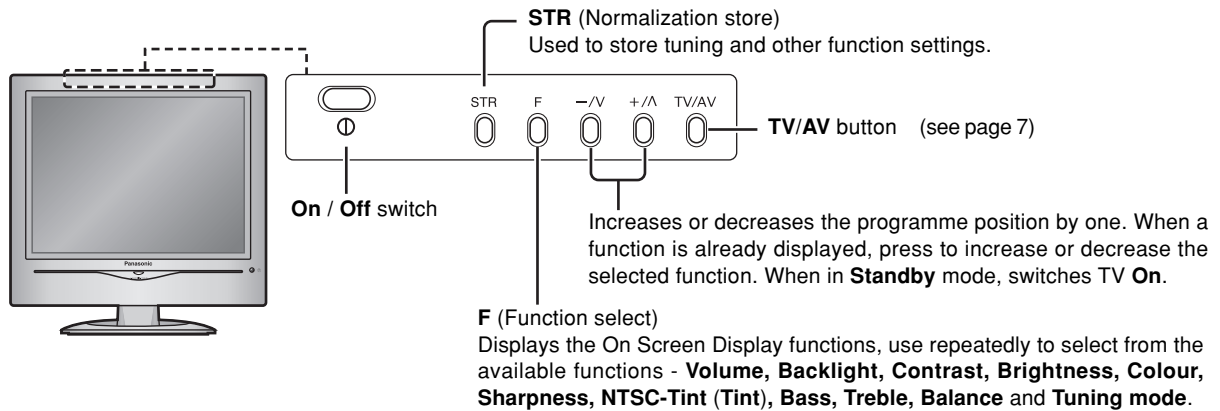

## Using the On Screen Displays

Many features available on this TV can be accessed via the On Screen Display menu system. Use the remote control as shown below to access and adjust features as desired.

The **MENU** button is used to open the main menus and also to return to the previous menu.

The up and down cursor buttons are used to move the cursor and select menus.

The left and right cursor buttons are used to access menus, adjust levels or to select from a range of options.

The **OK** button is used with a number of features to store settings after adjustments have been made or options have been set.

The **TV/AV** button is used to exit the menu system and return to the normal viewing screen.

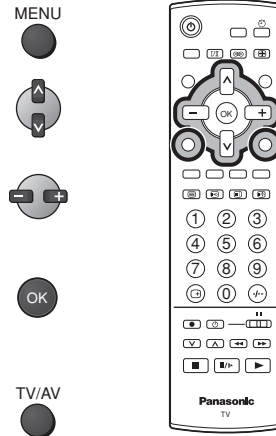

An On Screen Help box is displayed whenever a menu is displayed on the TV. This Help box indicates which buttons on the remote control are used to navigate the menu shown, see above for descriptions of button functions.

**ON SCREEN HELP**  
**'Instructions' box**

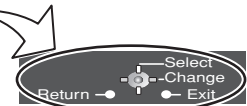

**Note:**

The Help box is not shown in the menu pictures in this instruction book due to space limitations.



## Language (Not available for TX-20LA2A)

You can select the On Screen Display language.

Press the **MENU** button.

Move to choose **Language**.

Access **Language**.

Select the language.

• TX-20LA2M

English / Chinese / Arabic

• TX-20LA2X

English / Persian / French / Arabic

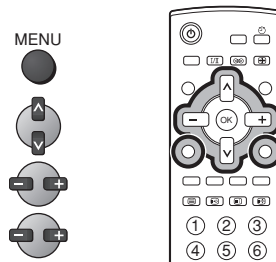

Example: TX-20LA2M

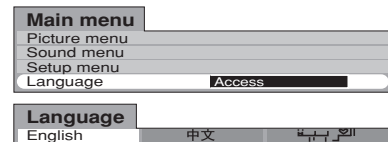

Press the **TV/AV** button at any time to go back to watching TV.



# Tuning

## Tuning menu

During **TV mode**

Press the **MENU** button.

Move to choose **Setup menu**.

Access **Setup menu**.

Move to choose **Tuning menu**.

Access **Tuning menu**.

Move to choose menu option.

Adjust chosen option or access chosen menu.

Press the **TV/AV** button at any time to go back to watching TV.

Pressing the **OK** button after having adjusted some features will store the setting as the default (replacing the factory setting).

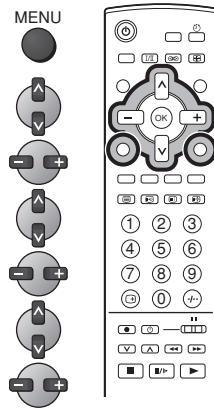

TV/AV



Example: TX-20LA2M

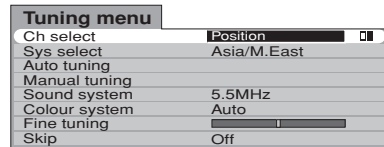
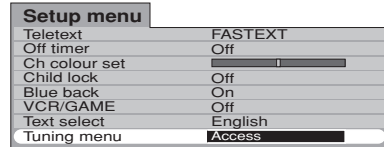

**Ch select** (Channel selection) Not available for TX-20LA2A. Select the most easily viewed channel selection method. See page 13.  
Position / Direct

**Sys select** (System selection) Select the system.

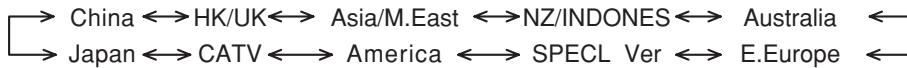

Sys select	REGION
China	China
HK/UK	Hong Kong, United Kingdom
Asia/M.East	Malaysia, Singapore, Thailand, Asia countries, Kuwait, Saudi Arabia, United Arab Emirates, Middle East countries, etc.
NZ/INDONES	New Zealand, Indonesia, etc.
Australia	Australia
E-Europe	CIS, Poland, etc.
SPECL Ver	South Africa
America	USA, Chile, Mexico, Panama, Peru, Philippines, Taiwan, Venezuela, etc.
CATV	USA CATV
Japan	Japan

**Auto tuning** Allows you to automatically retune the TV. Useful if you move house and wish to retune your TV to the local stations. See page 14.

**Manual tuning** Allows individual program positions to be tuned, manually. See page 15.

**Sound system** Allows you to change the sound system used for a programme channel. Choose the required sound system:  
4.5 MHz / 5.5 MHz / 6.0 MHz / 6.5 MHz

**Colour system** Lets you select the correct transmission standard for the transmission signal being received. See page 19.  
Auto / PAL / SECAM / NTSC 4.43 / NTSC 3.58

**Fine tuning** Use to make small adjustments to the tuning of an individual station (useful for example when weather conditions are affecting reception quality of a program). To cancel the Fine tuning, tune again by Manual tuning.

**Skip** It is possible to skip Program Number on which no TV stations are tuned appearing on the screen. The function is only effective when pressing the Program Number up or down button either on the TV set or on the remote control. Under the normal viewing, select the Program Number you would like to skip. Then, access Tuning menu and set Skip to On.

# Tuning

## Channel Selection (Not available for TX-20LA2A)

Select the most easily viewed channel selection method.

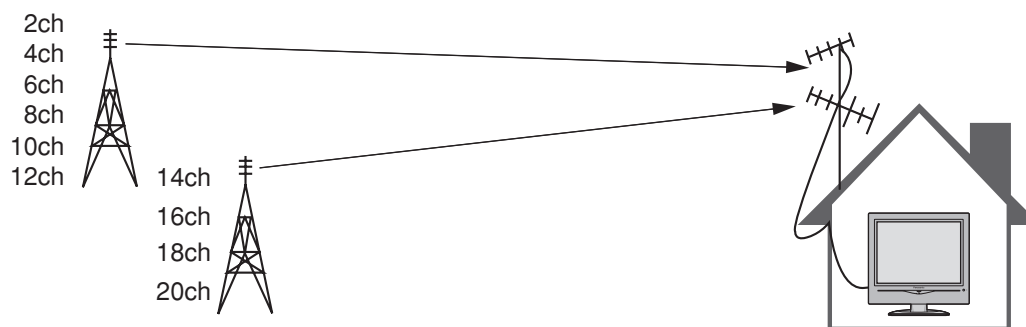

### Example

Programme Number	Channel Display	Received Channel
1	2	2
2	4	4
3	6	6
4	8	8
5	10	10
6	12	12
7	14	14
8	16	16
9	18	18
10	20	20

### Position

When the Ch select is on Position, and Auto tuning is performed, the unit memorises the channels tuned in order from Programme No.1.

Press the ① button to view channel 2.

Press the ② button to view channel 4.

Press the ③ button to view channel 6.

During Position mode various reception channels can be viewed.

### Example

Programme Number	Channel Display	Received Channel
1	—	—
2	2	2
3	—	—
4	4	4
5	—	—
6	6	6
7	—	—
8	8	8
9	—	—
10	10	10
⋮	⋮	⋮
20	20	20
⋮	⋮	⋮

### Direct

When the Ch select is on Direct, and Auto tuning is performed, the unit memorises the Programme Number which is the same as the channel tuned. This method allows you to select the desired channel by pressing the Channel Display number directly on the remote control to select the station. The Channel Display numbers for the broadcast stations in each region are listed on page 16.

# Tuning

## Auto tuning

Auto tuning automatically retunes your TV. This feature is useful if, e.g., you move house and wish to retune your TV to receive the local stations.

▶ Press the **MENU** button.

Move to choose **Setup menu**.

Access **Setup menu**.

Move to choose **Tuning menu**.

Access **Tuning menu**.

Move to choose **Auto tuning**.

Access **Auto tuning**.

### Notes:

- If you proceed with the next step all tuning data will be erased (all stations and their programme positions stored in your TV's memory will be wiped out so the new settings can be stored).
- If you exit the procedure after this point and before **Auto tuning** is complete, no station information will be stored. Restart and complete the Auto tuning procedure so that the TV is returned.

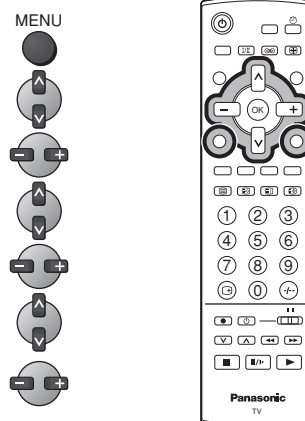

Press to start **Auto tuning**.

The TV will search for, locate, store and then sort into order your local stations.

Once this operation is completed the TV will display the programme now stored on programme position 1.

Press the **TV/AV** button at any time to go back to watching TV (please read the **Notes** in the above procedure).



Example: TX-20LA2M

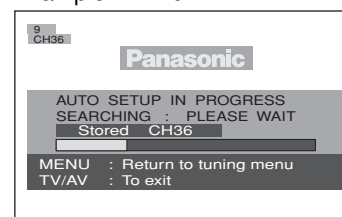

## Auto tuning (via top panel)

It is also possible to use the control panel buttons on the top of the TV to tune individual programme positions:

Press **F** until **Tuning mode** is reached.

Press **-/V** or **+/\A** to access **Tuning mode**.

Press **F** until **Auto tuning** is reached.

Press **-/V** or **+/\A** to start search.

Press **TV/AV** at any time to exit the Tuning menu.

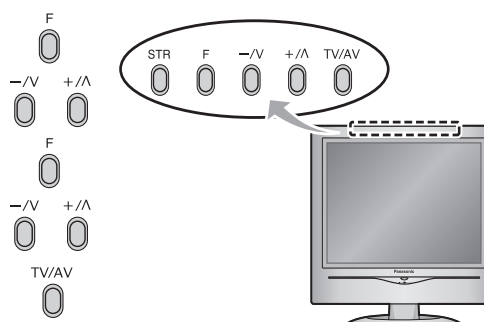

### Notes:

- If a clear picture with correct colours cannot be obtained when a Broadcast or AV signal is received, refer to the Colour system selection on page 12.
- After the Auto tuning is finished, press the Programme Number up button to confirm the tuning condition for each Programme Number. If some Programme Numbers are unused, it is possible to skip such Programme Numbers. Please refer to the Skip function on page 12.

# Tuning

## Manual tuning

It is possible to retune individual programme positions:

Press the **MENU** button.

Move to choose **Setup menu**.

Access **Setup menu**.

Move to choose **Tuning menu**.

Access **Tuning menu**.

Move to choose **Manual tuning**.

Access **Manual tuning**.

Select the programme position to be tuned.

Press repeatedly until required station is found.

When the desired station is found, press the **OK** button to store. The programme position will flash.

Press the **TV/AV** button at any time to go back to watching TV.

MENU

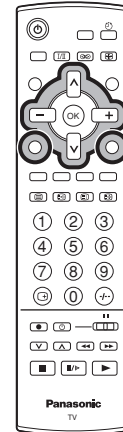

Example: TX-20LA2M

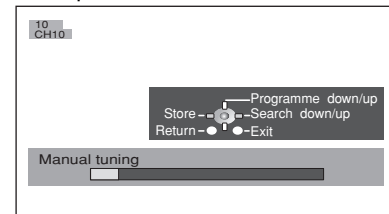

## Manual tuning (via top panel)

It is also possible to use the control panel buttons on the top of the TV to tune individual programme positions:

Press **F** until **Tuning mode** is reached.

Press **-/V** or **+/\A** to access **Tuning mode**.

Press **F** until **Manual tuning** is reached.

Press **-/V** or **+/\A** to access **Manual tuning**.

Press **TV/AV** to move between Change programme, Search and Change sound system.

Press **-/V** or **+/\A** to change programme position or start search.

When the desired station is found, press **STR** to store.

The programme position will flash.

Repeat above procedure to tune additional programme positions.

Press **F** at any time to exit the Tuning menu.

F

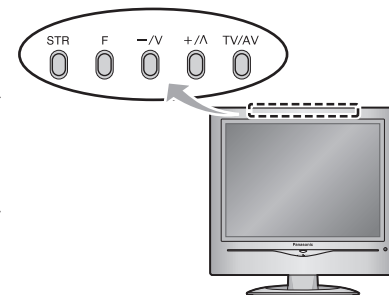

Example: TX-20LA2M

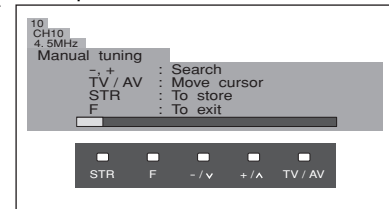

### Notes:

- If a clear picture cannot be obtained even when a Broadcast or AV signal is received, refer to the Colour system selection on page 12.
- After the Manual tuning is finished, press the Programme Number up button to confirm the tuning condition for each Programme Numbers. If some Programme Numbers are unused, it is possible to skip such Programme Numbers. Please refer to the Skip function on page 12.
- When using a VCR without video and audio input / output terminals, it is convenient to connect the aerial cable as indicated in the instruction manual of VCR and to set the designated channel to Programme No."0". In that case, perform Manual tuning after setting the Colour system and Sound system in advance. Further, in multi-system VCR, it is more convenient to set the designated channel to several Programme Numbers.

# Channel Allocation

Sys select	China	HK/UK	Asia/M.East	NZ/INDONES	Australia	E.Europe	SPECL Ver	America	CATV	Japan
CH DISPLAY	RECEIVE CHANNEL									
0	-	-	-	-	-	-	-	-	-	-
1	1	-	-	1	0	1	1	-	1	1
2	2	-	2	2	1	2	2	2	2	2
3	~	-	~	~	2	~	~	~	~	~
4	~	-	~	~	3	~	~	~	~	~
5	~	-	~	~	4	~	~	~	~	~
6	~	-	~	~	5	~	~	~	~	~
7	~	-	~	~	S2	~	~	~	~	~
~	~	-	~	~	~	~	~	~	~	~
11	~	-	11	11	~	11	11	~	~	~
12	12	-	12	-	~	12	12	~	~	12
13	13	-	-	-	~	-	13	13	~	13
14	~	-	-	-	~	-	~	14	~	~
15	~	-	-	-	S10	-	-	~	~	~
16	~	-	-	-	6	-	-	~	~	~
~	~	-	-	-	~	-	-	~	~	~
19	~	-	-	-	9	-	-	~	~	~
20	~	-	-	-	9A	-	-	~	~	~
21	~	21	21	21	10	21	21	~	~	~
22	~	~	~	~	11	~	~	~	~	~
23	~	~	~	~	12	~	~	~	~	~
24	~	~	~	~	S11	~	~	~	~	~
~	~	~	~	~	~	~	~	~	~	~
28	~	~	~	~	~	~	~	~	~	~
~	~	~	~	~	~	~	~	~	~	~
57	57	~	~	~	S44	~	~	~	~	~
58	~	~	~	~	20	~	~	~	~	~
59	~	~	~	~	21	~	~	~	~	~
~	~	~	~	~	~	~	~	~	~	~
62	~	62	62	62	~	62	62	62	62	62
63	~	63	63	63	~	63	63	63	63	C13
~	~	~	~	~	~	~	~	~	~	~
69	~	69	69	69	~	69	69	69	~	~
70	~	~	~	~	~	~	~	~	~	~
~	~	~	~	~	~	~	~	~	~	~
73	~	~	~	~	~	~	~	~	~	~
74	~	~	~	~	~	~	~	~	~	~
75	~	S'1	S'1	S'1	~	S'1	S'1	~	~	~
76	~	S'2	S'2	S'2	~	~	S'2	~	~	~
77	~	S'3	S'3	S'3	~	~	S'3	~	~	~
78	~	~	~	~	~	~	~	~	~	~
79	~	~	~	~	~	~	~	~	~	~
80	~	S1	S1	S1	~	S1	S1	~	~	~
81	Z1	S2	S2	S2	~	S2	S2	~	~	~
~	~	~	~	~	~	~	~	~	~	~
89	Z9	S10	S10	S10	~	S10	S10	~	~	~
90	Z10	S11	S11	S11	~	S11	~	~	~	~
91	Z11	S12	S12	S12	~	S12	~	~	~	~
92	Z12	S13	S13	S13	~	S13	~	~	~	~
93	Z13	S14	S14	S14	~	S14	S14	~	~	~
94	Z14	S15	S15	S15	~	S15	S15	~	~	~
95	Z15	S16	S16	S16	~	S16	S16	~	~	~
96	Z16	S17	S17	S17	~	S17	S17	~	~	~
97	Z17	S18	S18	S18	~	S18	S18	~	~	~
98	Z18	S19	S19	S19	~	S19	S19	~	~	~
99	Z19	S20	S20	S20	~	S20	S20	~	99	C49
100	Z20	S21	S21	S21	~	S21	S21	~	100	~
~	~	~	~	~	~	~	~	~	~	~
107	~	~	~	~	69	~	~	~	~	~
~	~	~	~	~	~	~	~	~	~	~
117	Z37	~	~	~	~	~	~	~	~	~
118	~	~	~	~	~	~	~	~	~	~
~	~	~	~	~	~	~	~	~	~	~
120	~	S41	S41	S41	~	S41	S41	~	~	~
~	~	~	~	~	~	~	~	~	~	~
125	~	~	~	~	~	~	~	~	125	~



# Picture menu

Press the **MENU** button.

Move to choose **Picture menu**.

Access **Picture menu**.

Move to choose menu option.

Adjust chosen option or access chosen menu.

Press the **TV/AV** button at any time to go back to watching TV.

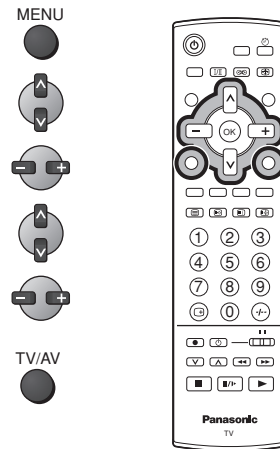

**Menu** Menu mode will be memorized for each TV, AV1 and AV2 mode.  
Dynamic / Standard / Cinema  
You can change the level of each Item (Backlight, Contrast, Brightness, Colour, Sharpness, NTSC-Tint, Colour temperature, AI and D.PNR) for each Menu (Dynamic, Standard and Cinema) according to your personal preference.

Example: TX-20LA2M

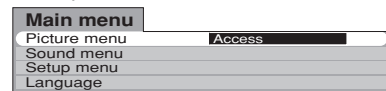

## Backlight, Contrast, Brightness, Colour, Sharpness

Increase or decrease the levels of these options according to your personal preference.

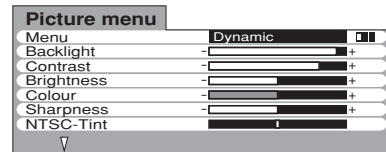

**NTSC-Tint (Tint)** The picture hue can be adjusted to suit your taste.

### Notes:

- When the TV is receiving NTSC signals, NTSC-Tint is displayed and level adjustment is possible.
- When the TV is receiving YUV (60Hz) signals, Tint is displayed and level adjustment is possible.

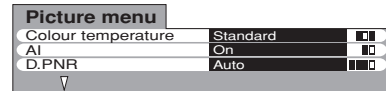

## Colour temperature

Allows you to set the overall colour tone of the picture. Choose from Cool, Standard and Warm.

## AI

Automatically analyses the incoming picture and processes it to give improved contrast and optimum depth of field.

## D.PNR

Automatically reduces unwanted picture noise.

### Note:

By pressing the **N** button on the remote control while the Picture menu is displayed, the selected menu will be changed to the Normal mode.

Normalization will not occur if the menu is not displayed when the **N** button is pressed.

The Normal mode is the factory preset condition. Returning to this original condition is called "Normalization".

# Sound menu

Press the **MENU** button.

Move to choose **Sound menu**.

Access **Sound menu**.

Move to choose menu option.

Adjust chosen option or access chosen menu.

Press the **TV/AV** button at any time to go back to watching TV.

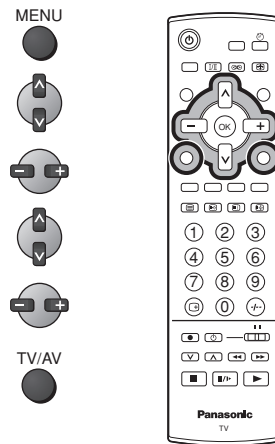

**Menu** Menu mode will be memorized for each TV, AV1 and AV2 mode.  
Music / News / Cinema  
You can change the level of each Item (Bass and Treble) for each Menu (Music, News and Cinema).

Example: TX-20LA2M



**Volume** Increase or decrease output volume.

**Bass** Increase or decrease level to enhance or minimise lower, deeper sound output.

**Treble** Increase or decrease level to enhance or minimise sharper, higher sound output.

**Balance** The levels of sound between the left and right speakers can be adjusted to suit your listening position.

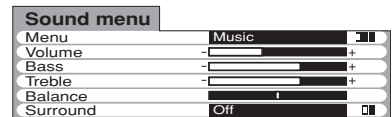

**Surround** To enjoy a concert hall effect, turn Surround to On. Switching is also possible by pressing the **SURROUND** button.  
The benefits of Surround sound are enormous. You can be completely enveloped in sound; just as if you were at a concert hall or cinema.  
The Surround effect can be obtained without the use of external Surround speakers.

**Note:**

By pressing the **N** button on the remote control while the Sound menu is displayed, the selected menu will be changed to the Normal mode.

Normalization will not occur if the menu is not displayed when the **N** button is pressed.

The Normal mode is the factory preset condition. Returning to this original condition is called "Normalization".

# Setup menu

Press the **MENU** button.

Move to choose **Setup menu**.

Access **Setup menu**.

Move to choose menu option.

Adjust chosen option or access chosen menu.

Press the **TV/AV** button at any time to go back to watching TV.

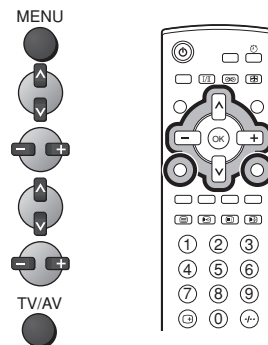

**Teletext** Allows you to choose 2 modes. See page 21.  
 • TX-20LA2A TOP / List  
 • other FASTEXT / List

**Off timer** Switches the TV off within a preset time which you can choose from between 0 to 90 minutes in 15 minute intervals. Switching is also possible by pressing the **Off timer** button.

**Ch colour set** Colour density varying between broadcast channels can be adjusted to three levels for each reception channel.

**Child lock** When On, picture and sound of the TV/AV mode being viewed will disappear and a Black screen will appear. Child lock can be set for each programme number and each AV mode.

**Blue back** You can choose Blue Back display On or Off when there is no signal.

**VCR/GAME** Reproduction of irregular signals, such as certain TV games and rental video tapes, may be improved.

**Colour system** Displayed during **AV** mode. If a clear picture with current colours cannot be obtained when a Broadcast or AV signal is received, this function is used.  
 Auto / PAL / SECAM / NTSC 4.43 / NTSC 3.58

PAL, SECAM and NTSC 3.58 are different colour signal broadcast transmission systems applicable to differing countries. NTSC 4.43 is a trick playback mode used in special VCR's to playback NTSC recorded video tapes through PAL television equipment.

**Text select** Not available for TX-20LA2A. Select character set, so that all characters needed are available for text on teletext pages.  
 English / CIS / E.Europe / Persian

**Tuning menu** Provides access to many other features including Sys select and Auto tuning. See page 12. Not displayed during AV mode.

Example: TX-20LA2M

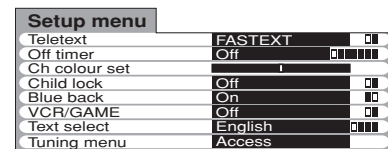
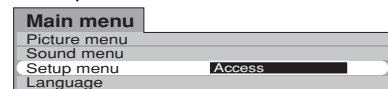

AV mode

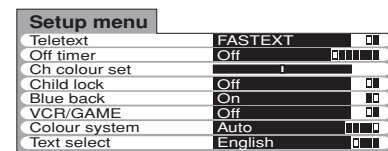

## Aspect Controls

The TV will allow you to enjoy viewing the picture at its optimum size and aspect.

ASPECT  

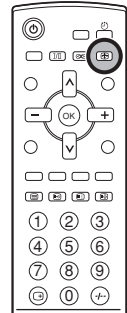
The aspect mode changes each time the **ASPECT** button is pressed.

4:3 ↔ 16:9

Mode	Picture	Explanation
4 : 3		<b>4:3</b> will display a 4:3 picture at its standard 4:3 size and can be selected if you wish to view in this format.
16 : 9		<b>16:9</b> will display a 16:9 picture at its standard 16:9 size and can be selected if you wish to view in this format.

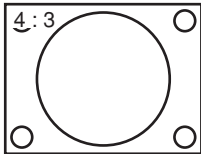
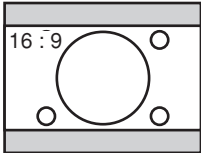
## Still

Press the **STILL** button to freeze the picture.  
 Press again to return to watching the current programme.

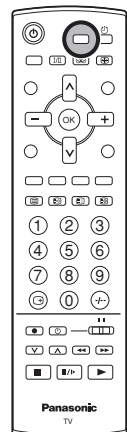

STILL  

**Note:**

Changes on NTSC-Tint (Tint) or D.PNR in the Picture menu during still mode will be reflected on the screen after exiting the mode.

## Teletext operation

- Teletext features may vary depending on the Broadcasting Companies and is only available if the channel selected is transmitting Teletext.
- Pressing the **MENU** button whilst in Teletext operation will display the backlight function with a white bar and the contrast function with a cyan bar, press  to alter the setting as required.
- Pressing the **MENU** button whilst in Teletext operation will display special function options at the bottom of the screen.
- Pressing the **MENU** button whilst in Teletext operation will display the volume function with a green bar, press  to alter the setting as required.

### What is List mode ?

In List mode, four differently coloured page numbers are situated at the bottom of the screen. Each of these numbers can be altered and stored in the TV's memory.

### What is FASTEXT or TOP mode?

In FASTEXT or TOP mode, four differently coloured subjects are situated at the bottom of the display. To access more information about one of these subjects, press the appropriately coloured button. This facility enables fast access to information on the subjects shown.

### Note:

If Teletext is in use, the aspect ratio is set to 16:9.



#### TV / Teletext mode

Press the **TV/TEXT** button to switch between the current programme and teletext.



#### Page Selection

Pages can be selected in two ways :

- Press the Up / Down buttons to increase or decrease the page number by one.
- By entering the page number, using 0 - 9 on the remote control.



#### Full / Top / Bottom

Press the **MENU** button to display special functions, followed by the **Green** button. Press the **Green** button again to expand the BOTTOM half. Press again to return to normal (FULL) size.



#### Reveal

Press the **MENU** button to display special functions, followed by the **Red** button to reveal hidden words e.g., quiz page answers. Press again to hide.



#### Red / Green / Yellow / Blue buttons

In FASTEXT or TOP mode they correspond to the differently coloured subjects. In List mode they correspond to the differently coloured page numbers.



#### List Store

In List mode the four page numbers can be altered (programme positions 1 - 25 only). To do this, press one of the four coloured buttons and enter the new page number. Press and hold the **OK** button, the page numbers will change to white indicating that the page is stored.



#### HOLD

To hold the Teletext page when viewing multi-page information. Press again to return to automatic page update.

## Teletext operation

It is not possible to change the programme position when in News flash, Update or Sub Coded Page Access operation.



### Favourite Page (F.P.)

Stores a favourite page in memory for instant recall. To store such a page, the TV must be in List mode, and the programme position must be from 1 - 25.

Press the **Blue** button, select the page number, then press and hold the **OK** button. The page number is now stored. Press **F.P.** to recall this page.

### Update Display

Press the **MENU** button to display special functions, followed by the **Yellow** button to view the TV picture whilst searching for a Teletext page. When found, the screen will display the page number at the top left. Press the **Yellow** button to view the page.

Press the **TV/TEXT** button again to return to normal TV operation.

### News Flash

When a news flash page has been selected, press the **MENU, Yellow** buttons, to view the TV picture. When an update is received, the page number will be displayed on screen.

Press the **Yellow** button to display the News Flash.

Press the **TV/TEXT** button to return to normal TV operation.

### Update

Press the **MENU, Yellow** buttons to see the update of information on certain pages.

When an update is received, the page number will be displayed at the top left of the screen.

Press the **Yellow** button to view the page.

Press the **TV/TEXT** button to return to normal TV operation.

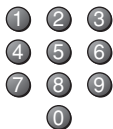

### Accessing sub pages

When Teletext information exceeds one page, it may take some time for the automatic changing of the sub pages to reach the sub page you require. As each sub page is found its number is displayed at the top of the page so that you may select it; as more sub pages are picked up, the display at the top of the page changes, so that you are always offered the most recently transmitted selection of sub pages.

In Teletext operation, use the following procedure to access sub pages:

If the sub page you want to look at is not yet available, press the **MENU** button (to display special functions) followed by the **Yellow** button to view the TV picture whilst waiting for more sub pages to be found. The sub pages found will be displayed across the top of the screen.

When the sub page you are waiting for is available press the **Yellow** button to return to viewing the Teletext pages, then use the left and right cursor buttons to select the sub page of your choice.

### Notes:

- If you do not want to display the on screen selector keys on the TV picture whilst waiting for a sub page to be found, press the **MENU** button to clear the keys from the screen. Press again to redisplay the keys.
- If you have cleared the special function keys from the screen and then used the left and right cursor buttons to select a sub page, whilst still viewing the TV picture, you must press the **MENU** button then the **Yellow** button to display the Teletext page again.
- If the top of the page indicates that sub pages are being transmitted but the page displayed never changes, then the 'sub page number' is there to show the page contents have been updated, there are no sub pages.

## Teletext operation



Alternatively, if you know which sub page you require, press the **MENU** button (to display special functions) followed by the **Blue** button; T\*\*\*\* will be displayed where the page number is normally found.

Enter desired sub page number before the T\*\*\*\* disappears.

e.g., to select page 6 enter 0, 0, 0 and 6.

Press the **Yellow** button to view the TV picture whilst waiting for more sub pages to be found. The sub pages found will be displayed across the top of the screen.

When the page is available, press the **Yellow** button to view the page. Regardless of how many pages are found, pressing the **Yellow** button will take you to the sub page which you requested.

Press the **TV/TEXT** button to return to normal TV operation.



### INDEX

#### When in FASTEXT or TOP operation

Press the **INDEX** button to return to the main index page.

Depending on the way information is transmitted, this may have to be pressed more than once to return to the main index page.

## VCR / DVD operation

The Remote Control is capable of operating some functions of selected VCR and DVD (Digital Versatile Disc) equipment. Some VCR and DVD equipment have different functions, so to ensure compatibility please refer to the equipment's instruction book or consult your dealer for details.



Button	Function
	Standby
	VCR / DVD selection switch
	Play
	Stop
	VCR : Fast Forward / Cue DVD : Slow / Search
	VCR : Rewind / Review DVD : Slow / Search
	Pause / Still
	VCR : Programme Number up / down DVD : Skip
	Record

## Stereo / Bilingual Sound Selection



When you receive the stereo / bilingual sound system, sound output modes can be selected by pressing the **Stereo / Bilingual Sound Selection** button.

Audio Signal	STEREO	MAIN I	SUB II	MONO
Mode Indicator		I	II	

**NICAM** .....Used in New Zealand, Singapore, Hong Kong etc.

Type of broadcast	Regular broadcast (Standard Audio)	Regular + NICAM MONO I (MAIN I)	NICAM STEREO	NICAM DUAL MONO (MAIN I / SUB II)
Mode Indicator	No Indicator $\longleftrightarrow \nabla$	I $\longleftrightarrow \nabla$	$\longleftrightarrow \nabla$	

**A2(German)** .....Used in Australia, Malaysia etc.

Type of broadcast	Regular broadcast (Standard Audio)	BILINGUAL or DUAL MONO: MAIN I / SUB II	STEREO
Mode Indicator	No Indicator $\longleftrightarrow \nabla$	I $\longleftrightarrow$ II	$\longleftrightarrow \nabla$

### Notes:

- If the stereo signal is poor or the receiving conditions are not optimum or if STEREO:MONO automatic switching occurs, it is recommended you switch from STEREO to MONO.
- Even when the contents of the receiving signal undergo changes, selection mode is kept intact.
- When the receiving conditions deteriorate, listening will be easier if the mode is set to the MONO position, using the stereo / bilingual sound selection button.
- DUAL, also known as DUAL MONO or as BILINGUAL is not currently transmitted in some countries.



## Remote control setting

Remote Control Operation is possible for the Panasonic VCR's and DVD's equipment.  
After completion of setting, execute the various operations after pressing the VCR / DVD selection switch.

Switch to select VCR or DVD.

While pressing the VCR / DVD Power button, press the manufacturer code (enter the two digit code), and press the VCR / DVD Stop button.

### VCR

Manufacturer	Code
Panasonic/ National	10,11,12,13

### DVD

Manufacturer	Code
Panasonic	70, 71

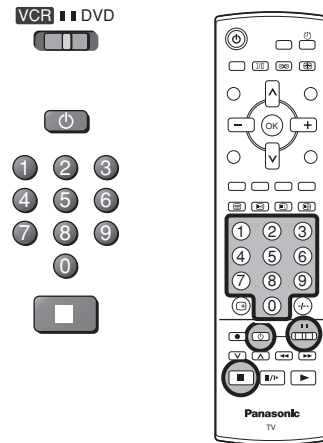

















### Notes:

- After setting, execute operation confirmation. If there is no operation, set a different code.
- The respective VCR / DVD code is cancelled when battery has been exchanged. Please set it again.
- Depending on the model, operation of VCR's or DVD's of the manufacturers listed above may not be possible.
- In some cases, new products may not be operative.
- It will not operate with other than the above manufacturers.

## Troubleshooting

If there is a problem with your LCD TV please refer to the table below to determine the symptoms, then carry out the suggested check. If this does not solve the problem, please contact your local Panasonic dealer, quoting the model number and serial number (both found on the rear of the TV).

Symptoms		Checks
Picture	Sound	
 Snowy Picture	 Noisy Sound	Aerial location, direction or connection
 Multiple Image	 Normal Sound	Aerial location, direction or connection
 Interference	 Noisy Sound	Electrical appliances Cars / Motorcycles Fluorescent lights
 Normal Picture	 No Sound	Volume level Sound mute switched on.
 No Picture	 No Sound	TV set to AV mode Not plugged into AC outlet. Not switched on. Picture / Sound controls set at minimum levels. Check if in Standby mode.
 No Colour	 Normal Sound	Colour Controls set at minimum levels. Colour system
 Poor or Distorted Picture	 Weak or No Sound	Retune Channel (s).
 Normal Picture	 Weak or distorted sound	Sound reception may have deteriorated. Sound system
There may be red spots, blue spots and green spots on the screen	 Normal Sound	This is a characteristic of liquid crystal panels and is not a problem. The liquid crystal panel is built with very high precision technology giving you fine picture details. Occasionally, a few non-active pixels may appear on the screen as a fixed point of blue, green, or red. Please note this does not affect the performance of your LCD.

## Maintenance

### To clean this unit, wipe with a soft, dry cloth.

If the surfaces are extremely dirty, use a soft cloth dipped in soap-and-water solution or a weak detergent solution.

- Use eyeglass cleaner to remove stubborn dirt from the LCD.
- Never use alcohol, paint thinner or benzine to clean this unit.
- Before using chemically treated cloth, read the instructions that came with the cloth carefully.
- Do not wipe the LCD with water.

### Wipe the cabinet with a soft cloth.

If the cabinet is heavily soiled, wipe with a well-wrung soft cloth dipped in kitchen cleanser (neutral) diluted with water.

### CAUTION:

If water or similar substances get inside the monitor via the liquid crystal panel surface, a malfunction may result.

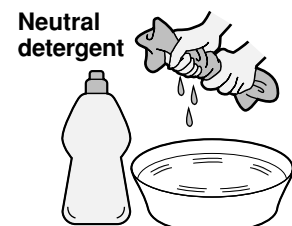

# Specifications

<b>Power Source</b>	AC 110 - 240 V, 50 / 60 Hz																								
<b>Power Consumption</b>	Average use : 68 W Standby condition : 0.5 W																								
<b>LCD</b>	19.6-inch (50 cm) 4:3 aspect ratio LCD panel (640 × 480 pixels)																								
<b>Screen Size</b>	401 mm (W) × 299 mm (H)																								
<b>Sound</b>																									
<b>Speaker</b>	9 cm × 5 cm, 2 pcs, 16 Ω																								
<b>Audio Output</b>	6 W (3 W + 3 W), 10 % THD																								
<b>Headphones</b>	M3 (3.5 mm) Jack × 1																								
<b>Receiving Systems / Band name</b>	<table border="1" style="width: 100%; border-collapse: collapse;"> <thead> <tr> <th style="width: 5%;">17 Systems</th> <th style="width: 70%;">Function</th> </tr> </thead> <tbody> <tr> <td>1 PAL B, G, H</td> <td rowspan="7">Reception of broadcast transmissions and Playback from Video Cassette Tape Recorders</td> </tr> <tr> <td>2 PAL I</td> </tr> <tr> <td>3 PAL D, K</td> </tr> <tr> <td>4 SECAM B, G</td> </tr> <tr> <td>5 SECAM D, K</td> </tr> <tr> <td>6 SECAM K1</td> </tr> <tr> <td>7 NTSC M (NTSC 3.58 / 4.5 MHz)</td> </tr> <tr> <td>8 NTSC 4.43 / 5.5 MHz</td> <td rowspan="7">Playback from Special VCR's</td> </tr> <tr> <td>9 NTSC 4.43 / 6.0 MHz</td> </tr> <tr> <td>10 NTSC 4.43 / 6.5 MHz</td> </tr> <tr> <td>11 NTSC 3.58 / 5.5 MHz</td> </tr> <tr> <td>12 NTSC 3.58 / 6.0 MHz</td> </tr> <tr> <td>13 NTSC 3.58 / 6.5 MHz</td> </tr> <tr> <td>14 SECAM I</td> </tr> <tr> <td>15 PAL 60 Hz / 5.5 MHz</td> <td rowspan="3">Playback from Special Disc Players and Special VCR's</td> </tr> <tr> <td>16 PAL 60 Hz / 6.0 MHz</td> </tr> <tr> <td>17 PAL 60 Hz / 6.5 MHz</td> </tr> </tbody> </table>			17 Systems	Function	1 PAL B, G, H	Reception of broadcast transmissions and Playback from Video Cassette Tape Recorders	2 PAL I	3 PAL D, K	4 SECAM B, G	5 SECAM D, K	6 SECAM K1	7 NTSC M (NTSC 3.58 / 4.5 MHz)	8 NTSC 4.43 / 5.5 MHz	Playback from Special VCR's	9 NTSC 4.43 / 6.0 MHz	10 NTSC 4.43 / 6.5 MHz	11 NTSC 3.58 / 5.5 MHz	12 NTSC 3.58 / 6.0 MHz	13 NTSC 3.58 / 6.5 MHz	14 SECAM I	15 PAL 60 Hz / 5.5 MHz	Playback from Special Disc Players and Special VCR's	16 PAL 60 Hz / 6.0 MHz	17 PAL 60 Hz / 6.5 MHz
17 Systems	Function																								
1 PAL B, G, H	Reception of broadcast transmissions and Playback from Video Cassette Tape Recorders																								
2 PAL I																									
3 PAL D, K																									
4 SECAM B, G																									
5 SECAM D, K																									
6 SECAM K1																									
7 NTSC M (NTSC 3.58 / 4.5 MHz)																									
8 NTSC 4.43 / 5.5 MHz	Playback from Special VCR's																								
9 NTSC 4.43 / 6.0 MHz																									
10 NTSC 4.43 / 6.5 MHz																									
11 NTSC 3.58 / 5.5 MHz																									
12 NTSC 3.58 / 6.0 MHz																									
13 NTSC 3.58 / 6.5 MHz																									
14 SECAM I																									
15 PAL 60 Hz / 5.5 MHz	Playback from Special Disc Players and Special VCR's																								
16 PAL 60 Hz / 6.0 MHz																									
17 PAL 60 Hz / 6.5 MHz																									
<b>Receiving Channels</b>	Regular TV	<b>VHF BAND</b>	<b>UHF BAND</b>																						
		2-12 (PAL / SECAM B, K1)	21-69 (PAL G, H, I / SECAM G, K, K1)																						
		0-12 (PAL B AUST.)	28-69 (PAL B AUST.)																						
		1-9 (PAL B N.Z.)	13-57 (PAL D, K)																						
		1-12 (PAL / SECAM D)	13-62 (NTSC M Japan)																						
		1-12 (NTSC M Japan)	14-69 (NTSC M USA)																						
		2-13 (NTSC M USA)																							
			<b>CATV</b>																						
			S1-S20 (OSCAR)																						
			1-125 (USA CATV)																						
			C13-C49 (JAPAN)																						
			S21-S41 (HYPER)																						
			Z1-Z37 (CHINA)																						
			5A,9A (AUST.)																						
<b>Aerial - Rear</b>	UHF / VHF																								
<b>Operating Conditions</b>	Temperature : 5 °C - 40 °C Humidity : 5 % - 90 % RH (non-condensing)																								
<b>Connection Terminals</b>																									
<b>AV1</b>	VIDEO (RCA Pin Type)	1.0 Vp-p (75 Ω)																							
	S-VIDEO (MINI DIN 4-pin)	Y:1.0 Vp-p (75 Ω) C:0.286 Vp-p (75 Ω)																							
	AUDIO L-R (RCA Pin Type × 2)	0.5 Vrms																							
<b>AV2</b>	VIDEO (RCA Pin Type)	1.0 Vp-p (75 Ω)																							
	AUDIO L-R (RCA Pin Type × 2)	0.5 Vrms																							
	Y	1.0 Vp-p (including synchronization)																							
	P <sub>B</sub> / P <sub>R</sub>	±0.35 Vp-p																							
<b>MONITOR OUT</b>	VIDEO (RCA Pin Type)	1.0 Vp-p (75 Ω)																							
	AUDIO L-R (RCA Pin Type × 2)	0.5 Vrms																							
<b>Dimensions ( W × H × D )</b>																									
<b>Including TV Stand</b>	498 mm × 506 mm × 260 mm																								
<b>TV Set Only</b>	498 mm × 450 mm × 90 mm																								
<b>Weight</b>	8.3 kg Net																								

**Note:**

Design and Specifications are subject to change without notice. Weight and Dimensions shown are approximate.

**How to hang the LCD TV on the wall**

This LCD TV is for use only with the following optional accessory.

- Wall-hanging bracket ..... TY-WK22LR1W

Always be sure to ask a qualified technician to carry out set-up.

**WARNING**

- DO NOT use other optional accessories.



Use with any other type of optional accessories may cause instability which could result in the possibility of injury.

**Customer's Record**

The model number and serial number of this product can be found on its rear panel. You should note this serial number in the space provided below and retain this book, plus your purchase receipt, as a permanent record of your purchase to aid in identification in the event of theft or loss, and for Warranty Service purposes.

Model Number

Serial Number

---

**Matsushita Electric Industrial Co., Ltd.**Web Site : <http://www.panasonic.co.jp/global/>

© 2004 Matsushita Electric Industrial Co., Ltd. All Rights Reserved.

Printed in Japan  
MBS0604S1064