

Panasonic®

15.2" Diagonal LCD TV Operating Instructions

Model No. **TX-15LT2**

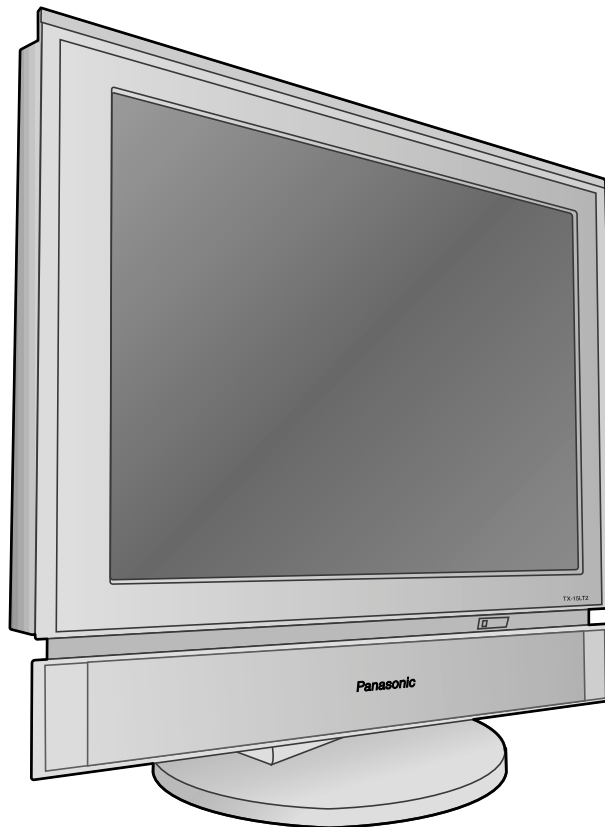

Please read these instruction before operating your set and retain them for future reference.

Dear Panasonic Customer

Welcome to the Panasonic family of customers. We hope that you will have many years of enjoyment from your new 15.2" Diagonal LCD TV.

To obtain maximum benefit from your set, please read these Instructions before making any adjustments, and retain them for future reference.

Retain your purchase receipt also, and note down the model number and serial number of your set in the space provided on the rear cover of these instructions.

Table of Contents

Warnings and precautions	3	Setup menu	17
Before Operating This Set	4	Tuning menu-overview	18
Supplied Accessories	4	Programme edit	19
Fitting remote control batteries	4	Auto setup	21
Receiver Location	5	Manual tuning	22
Optional External Equipment	5	Shipping condition	23
For optimum quality picture	5	Owner ID	24
How to use the LCD stand	5	Aspect Controls	25
Quick start Guide	6	Tuning your VCR and satellite reciver	27
1. Choose Your Connection Type	6	Advanced Remote Control Operation	28
2. Connecting the AC Adaptor	7	VCR / DVD Operation	28
3. Switch TV ON	7	TELE TEXT	29
4. Auto set up	7	Connections	32
5. Owner ID	8	How to connect the input terminals	32
6. The two basic functions	8	How to connect the AUDIO OUT terminals	33
Basic controls	9	Connecting Headphones / Earphones	33
Side panel controls and Remote control	9	Troubleshooting	34
Using the On Screen Displays	12	Maintenance	34
Picture menu	13	Specifications	35
Sound menu	15		

Before Operating This Set

Supplied Accessories

Check the accessories before installations.

- Operating Instruction book (TQBC0355)

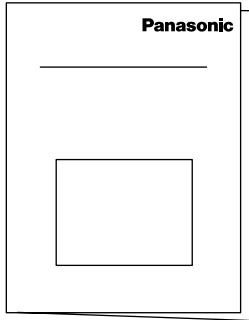

- Remote Control Transmitter (EUR511270)

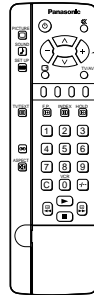

- Batteries for the Remote Control Transmitter (2 × R6 (UM3) size)

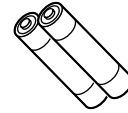

- AC Adaptor & Mains Lead
AC Adaptor: (N0JZHK000003)
Mains Lead: (K2CT3AA00001)

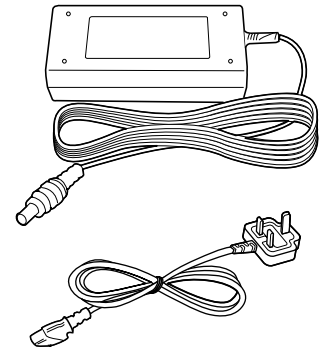

- Warranty Card

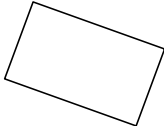

Fitting remote control batteries

1

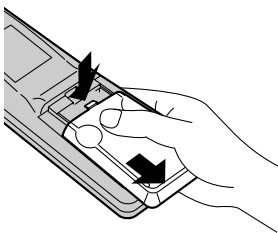

Slide off the battery cover

2

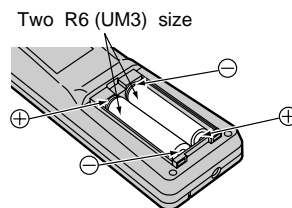

Insert batteries - note correct polarity (+ and -)

3

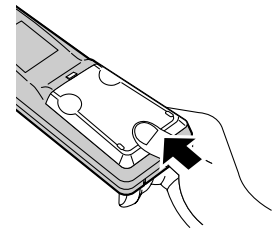

Replace the cover

- Make sure that the batteries are fitted the correct way round.
- Do not mix old batteries with new batteries. Remove old, exhausted batteries immediately.
- Do not mix different battery types, i.e. Alkaline and Manganese or use rechargeable (Ni - Cad) batteries.

Before Operating This Set

Receiver Location

Locate for comfortable viewing. Avoid placing where sunlight or other bright light (including reflections) will fall on the screen.

Use of some types of fluorescent lighting can reduce remote control transmitter range.

Adequate ventilation is essential to prevent internal component failure. Keep away from areas of excessive heat or moisture.

To insure optimum picture do not position magnetic equipment (motors, fans, other speakers, etc.) nearby.

Optional External Equipment

The Video/Audio connection between components can be made with shielded video and audio cables. For best performance, we recommend 75 ohm coaxial aerial cable is used. Cables are available from your dealer or electronic supply store.

Before you purchase any cables, be sure you know what type of output and input connectors your various components require. Also determine the length of cable you'll need.

For optimum quality picture

When the LCD is exposed to light from outdoors or lighting fixtures, high-contrast pictures may not be displayed clearly. Turn off florescent lamps near the LCD and place in a location not exposed to outdoor light.

How to use the LCD stand

Adjust the stand to your desired angle. The stand angle can be adjusted between 0 ° forward to 28 ° back.

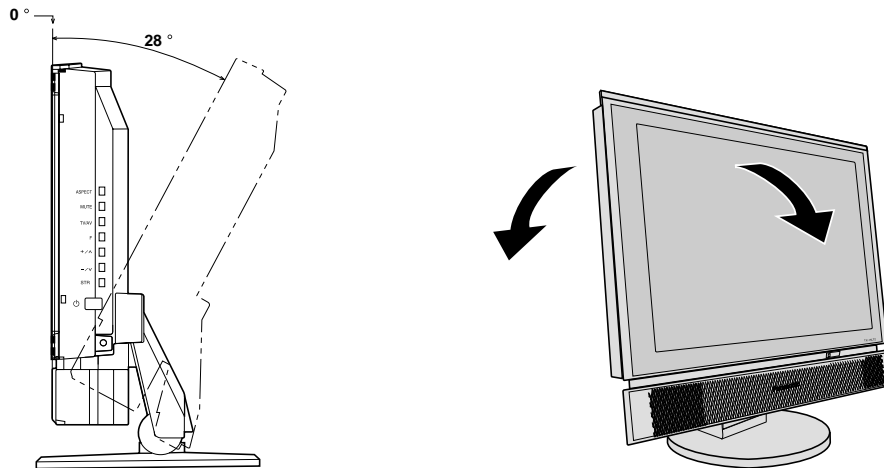

Quick start Guide

1. Choose Your Connection Type

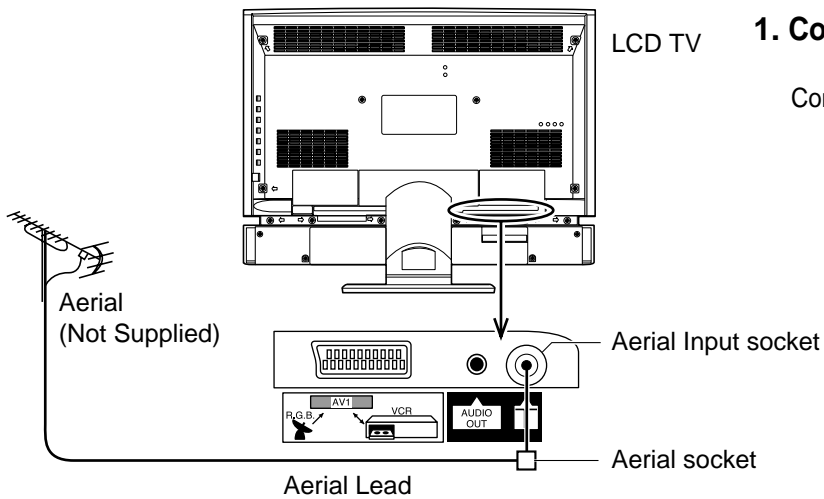

1. Connecting the TV directly to an aerial only

Connect the Aerial lead into the TV Aerial socket (T).

or

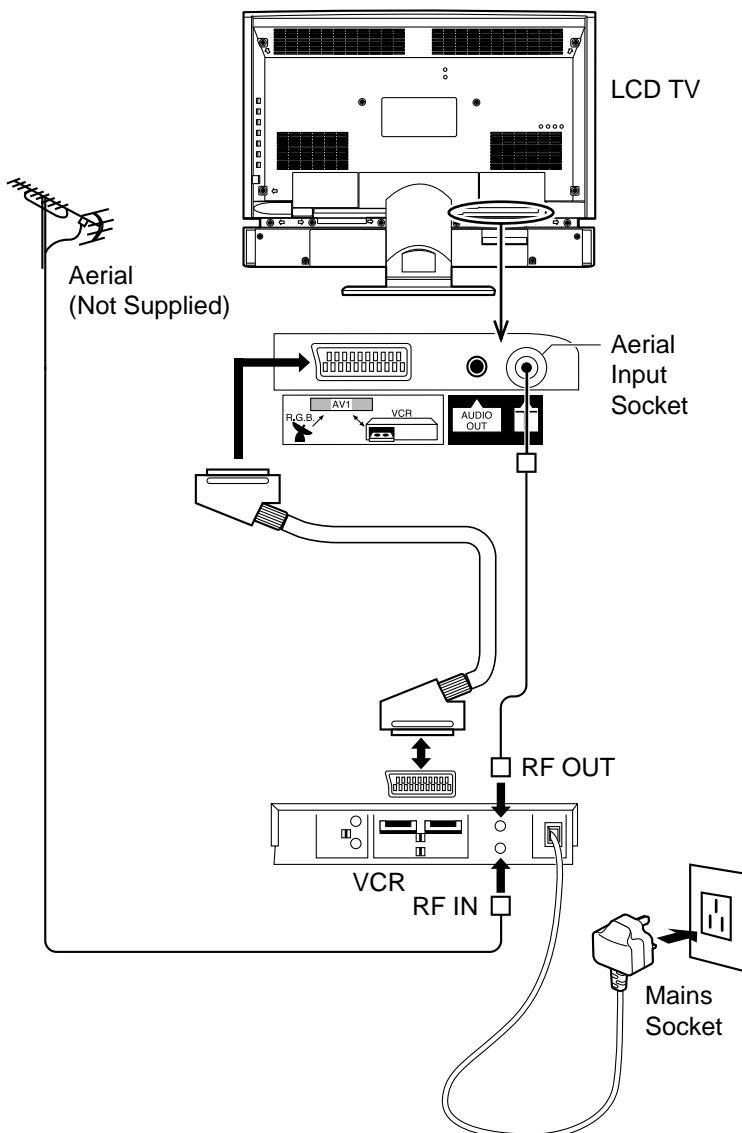

2. Connection of TV and VCR using Scart and RF

Connect the AERIAL to the Aerial in socket of the VCR and an RF cable from the VCR Aerial Out socket to the TV Aerial socket (T).

Scart Connections

The VCR can also be connected to the TV using a Scart cable. Connect AV1 of the VCR to AV1 Scart socket of this set.

Notes:

- Additional equipment and cables are not supplied.
- Further details of audio / video connections can be found on pages 32 and 33.

Quick start Guide

2. Connecting the AC Adaptor

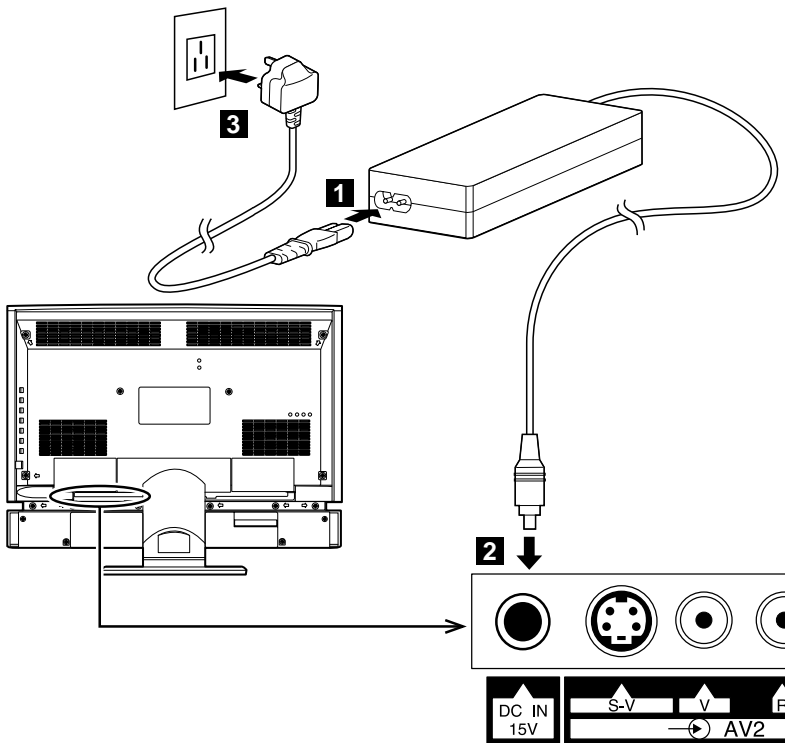

- 1** Connect the mains lead to the AC Adaptor.
- 2** Connect the AC Adaptor DC plug to the DC IN socket.
- 3** Plug into household mains socket.

- Be sure to use the power cord and AC adaptor included in the accessories.
- Do not use the AC adaptor for other than the specified equipment.
- Unplug the AC adaptor if it is not used for long time.
- Do not place any objects on the AC adaptor.
- Do not use the AC adaptor outdoors.
- Do not attempt to repair the AC adaptor if it is broken or malfunctioning. Refer the servicing to the service representative.
- Do not try to open the AC adaptor.
- Do not use water or wet cloth for cleaning the AC adaptor.



3. Switch TV ON

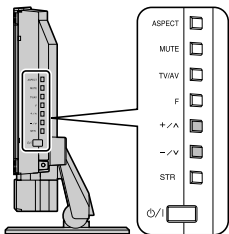

Power-Indicator

The RED LED when lit indicates that not only the TV set is in stand-by mode but also the external AC adaptor is still on.



Press the   switch on the LCD TV to turn the set on.

IMPORTANT NOTES

There are two ways to switch the TV set to stand-by mode.

- (A) Press the  switch on the LCD TV and check RED LED is lit.

OR

- (B) Press the  Stand-by button on the remote control.

The TV set cannot be switched on by the remote controller if it was switched to stand-by using method (A) or vice versa if method (B) was used.

When programme number up (∧)/down (∨) buttons on the side panel of the main part are pressed in stand-by mode, TV turns on.



4. Auto set up

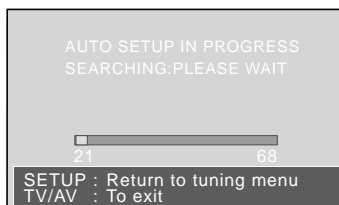

Programmes will appear immediately if your dealer has programmed the TV for you.

If the TV has not been programmed for you then **Auto setup** will begin, your stations will be located, sorted into order and stored ready for use.

Quick start Guide

5. Owner ID

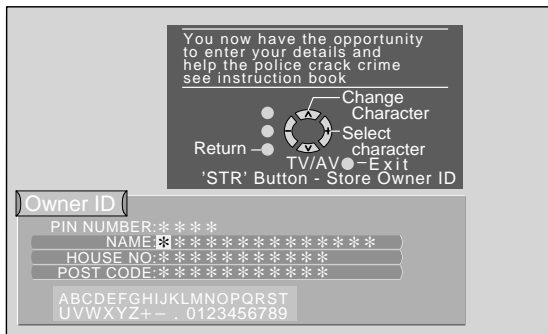

As an added feature, this TV has the option of entering a security code (Owner ID) and personal details into its memory, so that in the unfortunate event of theft it will help the police to trace the owner.

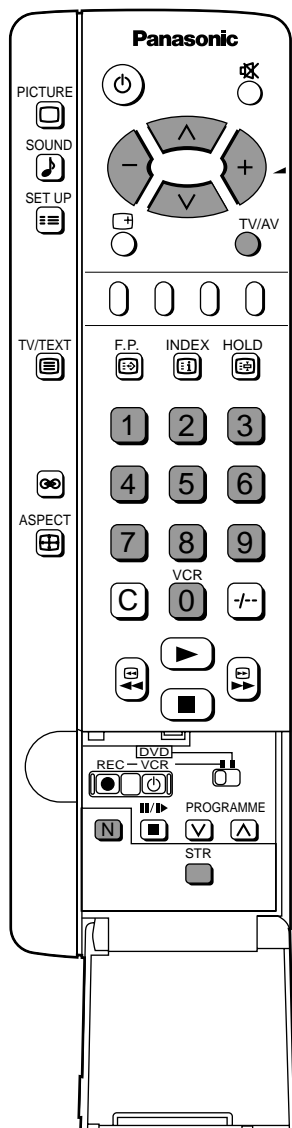

Enter required 4 digit Owner ID **PIN NUMBER** (using 0 to 9 on the remote control)



Press the **TV/AV** button at any time to exit the Owner ID feature without saving any information you may have entered.

Enter NAME, HOUSE NUMBER and POSTCODE

If a 4 digit **PIN NUMBER** was entered above, you will be taken automatically to the **NAME** line.



If not, move to the **NAME** line.



Change character.



Select character position.

Repeat above until **NAME, HOUSE NUMBER** and **POSTCODE** are entered.



Press **STR** to store the details

Press **STR** again, when you are asked "Are you sure?"

For further information on Owner ID, including how to view the details you have stored, see page 24.

A space is provided on page 24 to write down your **PIN NUMBER** for future reference.



We recommend that as soon as you have stored Owner ID details (or have exited the feature), the picture controls are reset to normal viewing levels. To do this, press the "N" button, found under the remote control's pull down flap.

6. The two basic functions.



Adjust Volume



Change Programme

You are now ready to begin viewing programmes
The cursor controls provide the two basic functions:

Basic controls

Side panel controls and Remote control

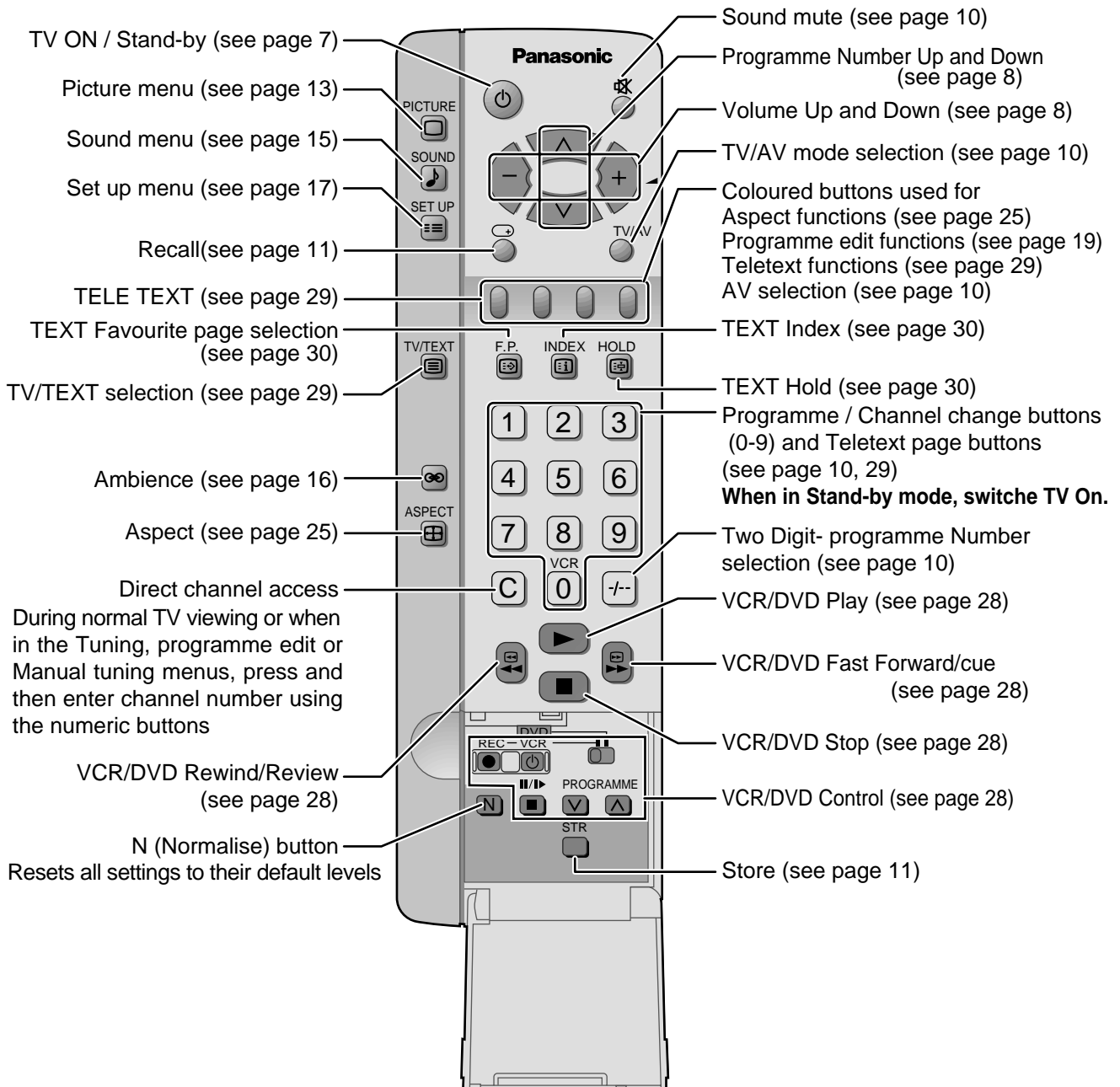
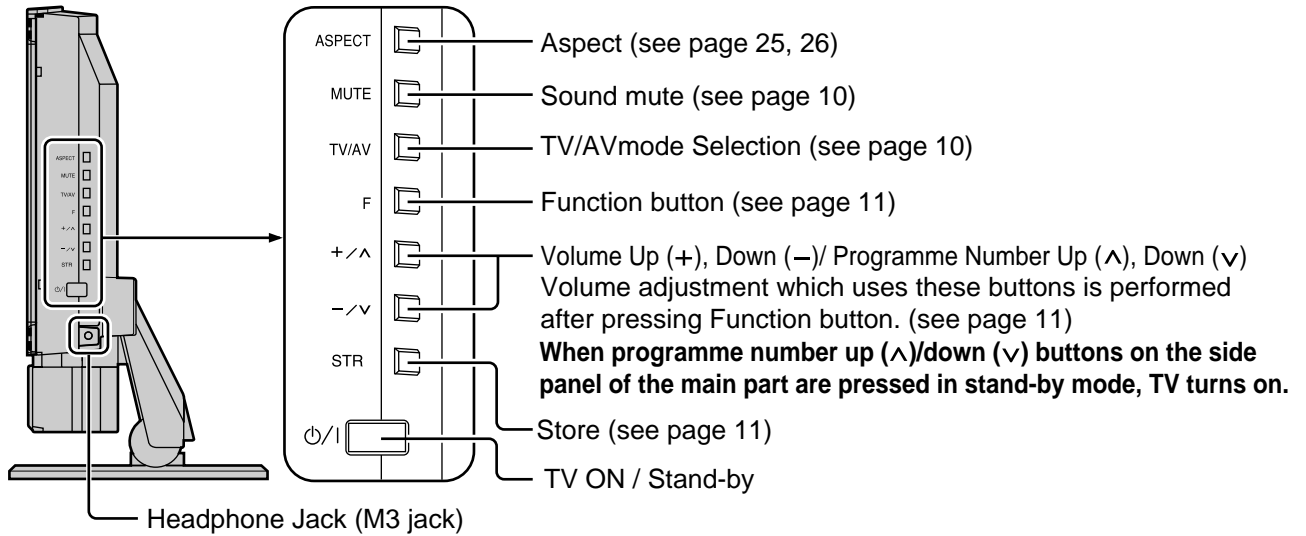

Basic controls

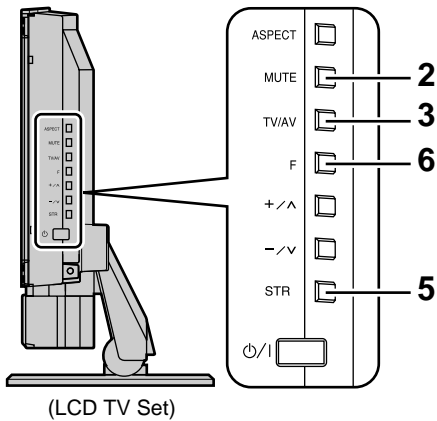

1

Direct Programme Number Selection (CH SELECT = POSITION)

You can select the numbers directly by pressing "Number 0-9" button and the two digit Numbers by pressing "Two Digit" and "Programme Number" buttons.

Programme Number 8 **8**

Programme Number 12..... **-/-** , **1** , **2**

Direct Programme Number Selection (CH SELECT = DIRECT)

You can select the number directly by pressing the "C" button and the corresponding programme number button.

Channel Number 21..... **C** , **2** , **1**

Channel Number 68..... **C** , **6** , **8**

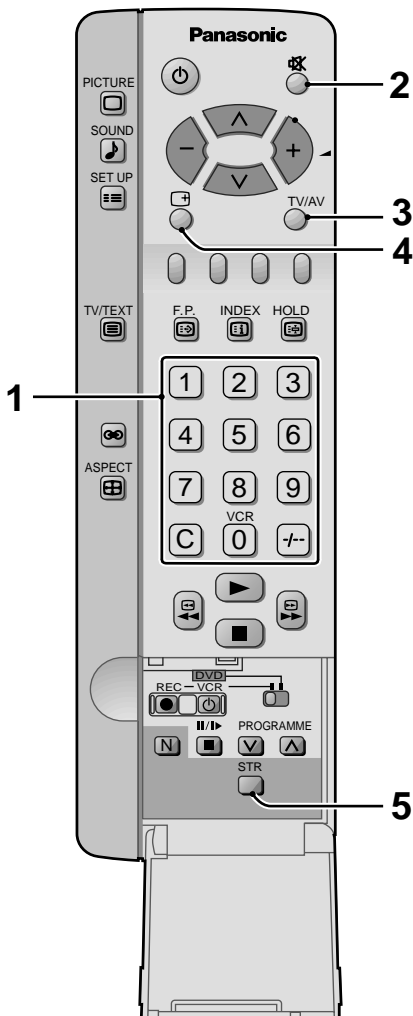

2

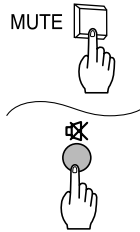

Mute button

Press this button to mute the sound completely.

The "Mute" symbol will appear.

Press the button once again to restore the previous sound level, and cancel the mute.

Sound is also reactivated when power is turned off or volume level is changed.

3



TV/AV Mode Selection

Press the "TV/AV" button to select TV, AV1, AV2, AV2S input signal modes sequentially.

Remote control :

Press the "TV/AV" menu button



Press the relevant on screen selector key to select the AV source you wish to view (for example, press the Red button to select AV1 if you have connected a video recorder to the AV1 SCART socket).

Otherwise, you can toggle between AV2 and AV2S with the Green button.

The on screen selector keys that appear clear after a few seconds. If you want to select an input when the keys are not shown, press the "TV/AV" key once more and the keys will reappear.

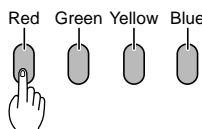

Note:

During AV mode selection, the picture from certain source signals may momentarily distort or change colour, but this is normal operation.

Basic controls

4



Recall button

Press to display programme position, programme name, channel number, time, NICAM mode, ASPECT mode and programme table.

5

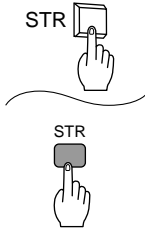

STR

Used to store tuning and other function settings.

Remote control :

Stores some settings in TUNING menus.

6



Function selection

Displays the on screen display functions, press repeatedly to select from the available functions.

The following adjustments can be accessed directly.

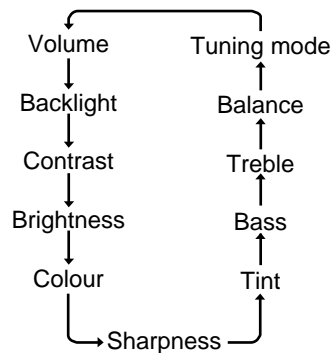

Notes:

- Tint : Displayed when receiving NTSC signals.
- Tuning mode : Not displayed during AV mode.

Using the On Screen Displays

Many features available on this TV can be accessed via the On Screen Display menu system. Use the remote control as shown below to access and adjust features as desired.

The **PICTURE**, **SOUND** and **SET UP** buttons are used to open the main menus.

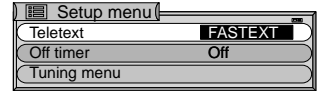
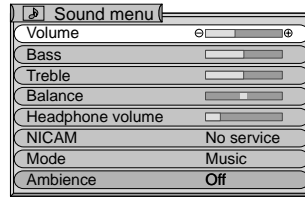
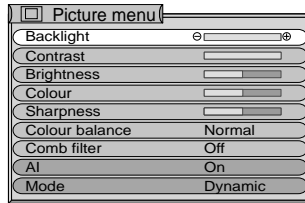
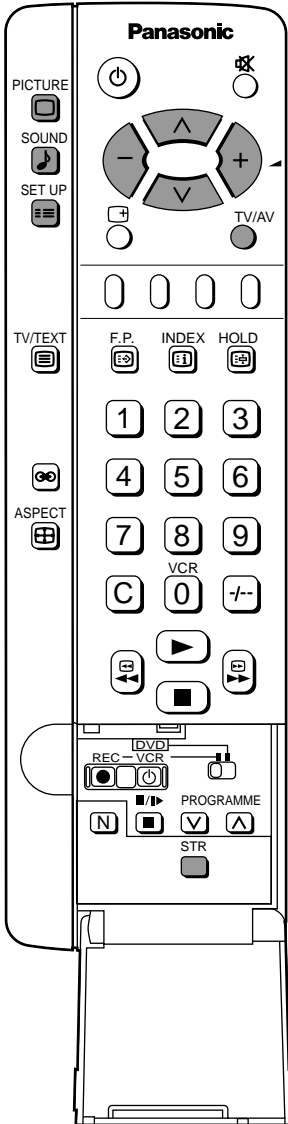

The UP and DOWN cursor buttons are used to move the cursor up and down the menus.



The LEFT and RIGHT cursor buttons are used to access menus, adjust levels or to select from a range of options.



The **STR** button is used with a number of features to store settings after adjustments have been made or options have been set.



The **TV/AV** button is used to exit the menu system and return to the normal viewing screen.

An On Screen Help box is displayed whenever a menu is displayed on the TV. This Help box indicates which keys on the remote control are used to navigate the menu shown, see above for descriptions of button functions.

Note:

If the On Screen Menu is opened in Zoom mode, the screen will be switched into 16:9 aspect ratio. The screen will return to Zoom mode after exiting the On Screen Menu.

**ON SCREEN HELP
'Instruction' box**

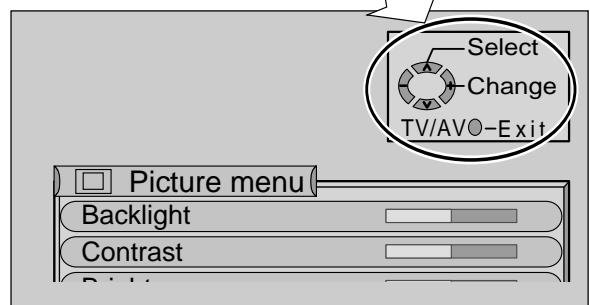

Picture menu

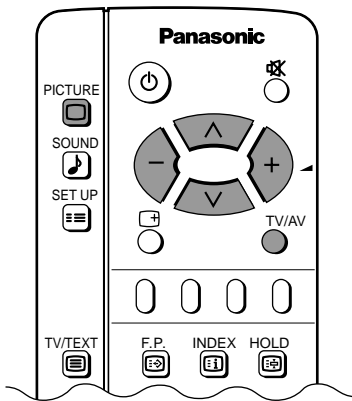

1 Press .

2 Move to chosen menu option by using or .

3 Adjust chosen option or access chosen menu by using or .

Press at any time to go back to watching TV.

Backlight, Contrast, Brightness, Colour, Sharpness, Tint

Increase or decrease the levels of Backlight, Contrast, Brightness, Colour and Sharpness options according to your personal preference.

With an NTSC signal source connected to the TV, the picture hue can be adjusted to suit your taste.

Item	Effect	Function
Backlight	 Darker Brighter	Brightness of the back light is adjusted.
Contrast	 Darker Brighter	Adjust for contrast.
Brightness	 Less More	Adjusts for easier viewing of dark pictures such as night scenes and hair.
Colour	 Less More	Adjusts slightly to a lighter
Sharpness	 Less More	Displays a sharp image.
Tint	 Less More	Adjust the picture hue.

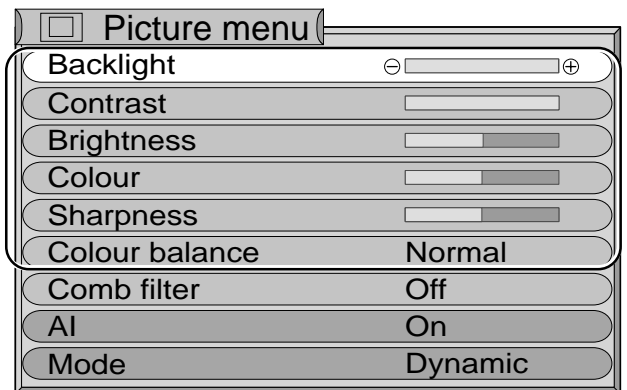

Note:

- When the TV is receiving NTSC Signals, Tint is displayed and level adjustment is possible.
- Only Contrast and Backlight will be displayed during TEXT mode.

Colour balance Allows you to set the overall colour tone of the picture.

Press or to switch between modes

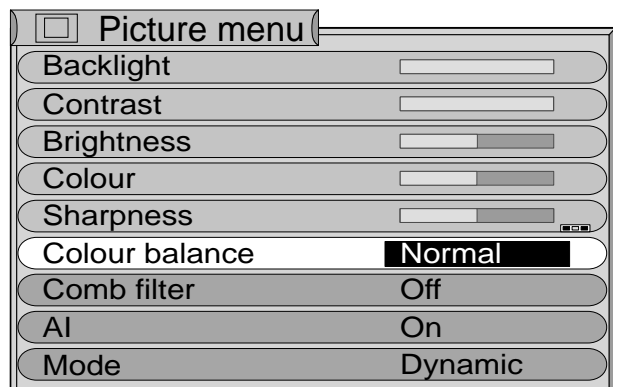
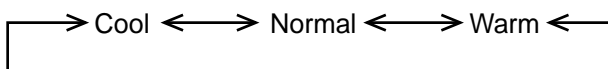

Picture menu

Comb filter

Reduces colour noise.

Not displayed during RGB Video input and S-Video input mode.

AI

Automatically analyses the incoming picture and processes it to give improved contrast and optimum depth of field.

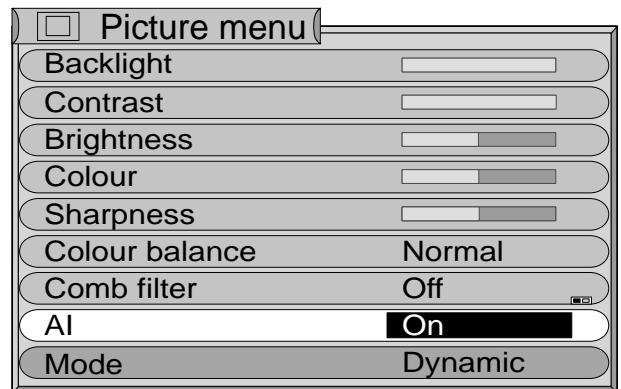

Mode

You can change the level of each Function (Backlight, Contrast, Brightness, colour, Sharpness, colour balance, comb filter, AI, Tint) for each picture menu.

Picture menu mode will be memorized for each TV, AV1, AV2 and AV2S mode.

Press or to switch between modes

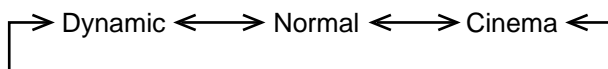
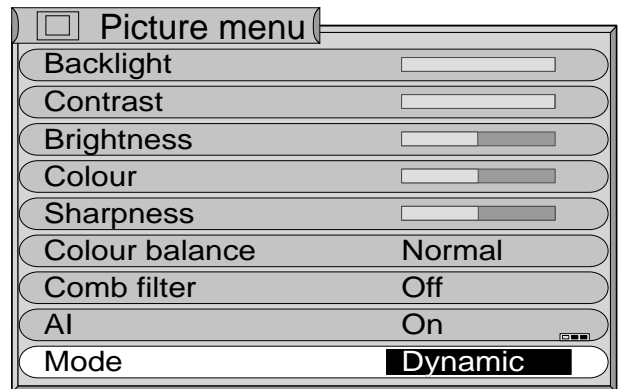

Mode	Function
Dynamic	Displays a bright screen with maximum contrast.
Normal	Displays standard image.
Cinema	Ideal for movies in the dark room.

Notes:

- The AV2 and AV2S inputs reference the same settings in memory.
- TINT appears only for NTSC input signals.

Helpful Hint (N Normalization)

The 'N' key has no effect if it is pressed when menu is displayed on the screen.

If the 'N' key is pressed when no menu is displayed on the screen, the user-preset original settings will be restored (this is not the factory default settings).

Sound menu

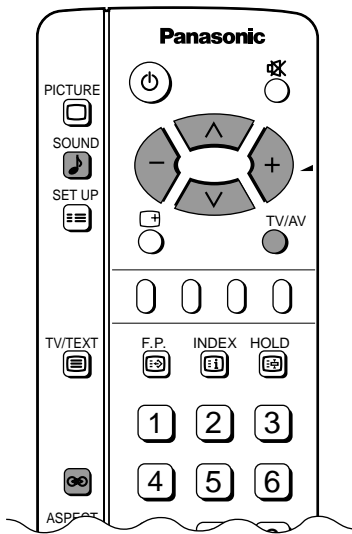

1 Press .

2 Move to chosen menu option by using or .

3 Adjust chosen option or access chosen menu by using or .

Press at any time to go back to watching TV.

Some features are only available with the Ambience feature switched off.

Press to switch between On and Off.

Volume, Bass, Treble, Balance, Headphone Volume

Item	Effect	Function
Volume		Adjusts output volume.
Bass		Adjusts lower deeper sounds.
Treble		Adjusts higher sharper sounds.
Balance		Adjusts the sound level difference between left and right speakers.
Headphone volume		Adjust Headphone volume.

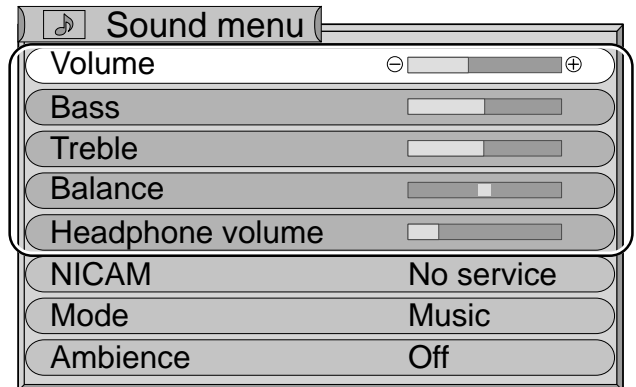

NICAM

Usually set to **stereo** to provide the best reproduction, but if reception deteriorates or if the service is not available then switch to **Mono**. **Mono (M1)** and **(M2)** can also be selected if a mono signal is being transmitted.

Not displayed during **AV** mode.

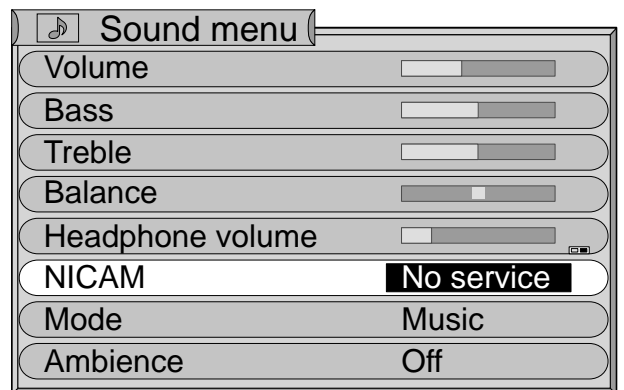

Sound menu

Mode

With the **Surround** feature switched **Off**, sound quality can be improved when watching music or speech by selecting the appropriate mode **Music** or **Speech**.

Press  or  to select Mode.

Music  Speech

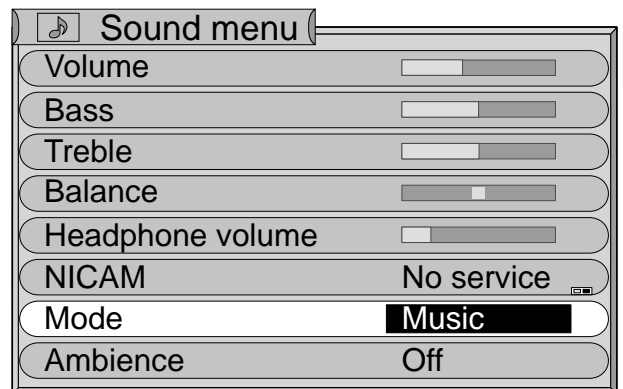

Ambience

To enjoy a concert hall effect, turn Ambience to on.

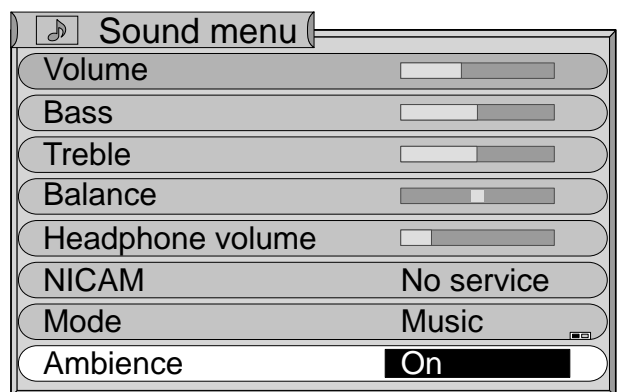

Helpful Hint (Normalization)

The 'N' key has no effect if it is pressed when menu is displayed on the screen.

If the 'N' key is pressed when no menu is displayed on the screen, the user-preset original settings will be restored (this is not the factory default settings).

Setup menu

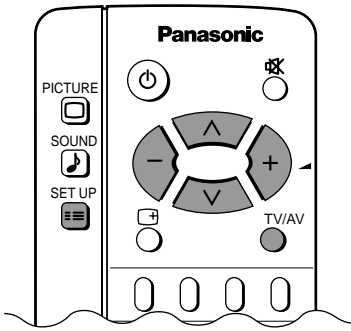

- 1 Press .
 - 2 Move to chosen menu option by using or .
 - 3 Adjust chosen option or access chosen menu by using or .
- Press at any time to go back to watching TV.

Teletext

Allows you to choose 2 modes.
(See page 29)

FASTEXT \longleftrightarrow List

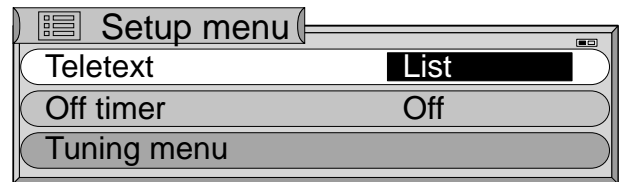

Off timer

Switches the TV off within a preset time which you can choose from OFF and between 15 to 90 minutes in 15 minute intervals.

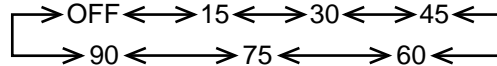

Tuning menu

Provides access to many other features including programme edit and Auto setup. (See page 18)
Not displayed during **AV** mode.

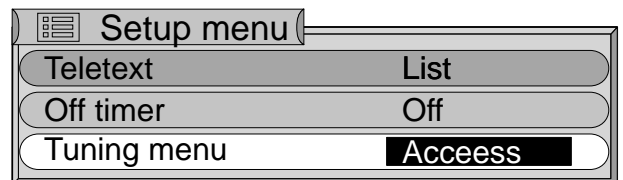

Volume correction





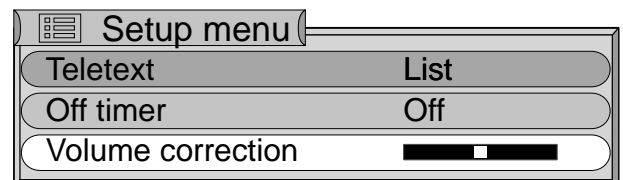



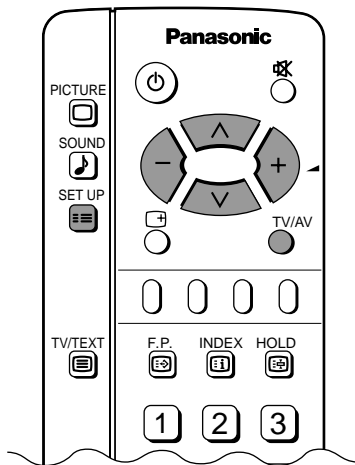

Lets you adjust the volume level of individual station. Use this feature if the volume level varies significantly between stations. Adjusting one station's volume to bring it into line with the other stations means you can avoid having to adjust the volume each time you change channels.

During **AV** mode, Volume correction is displayed.





Tuning menu-overview

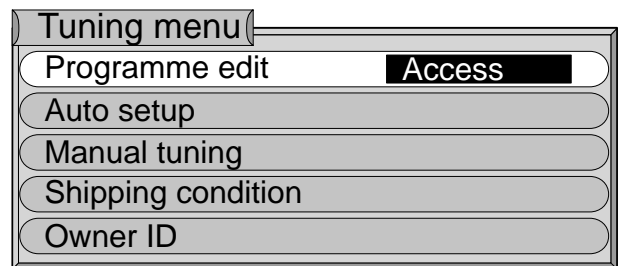

- 1 Press  .
 - 2 Move to the Tuning menu option by using  or  .
 - 3 Access Tuning menu by using  or  .
 - 4 Move to chosen menu option by using  or  .
 - 5 Adjust chosen option or access chosen menu by using  or  .
- Press  at any time to go back to watching TV.

- Programme edit** Access in order to customise your programme settings (eg: adding or deleting a programme position) see page 19.
- Auto setup** Allows you to automatically retune the TV. Useful if you move house and wish to retune your TV to the local stations. see page 21.
- Manual tuning** Allows individual programme positions to be tuned manually. see page 22.
- Shipping condition** Allows you to clear all tuning information and re-set all control levels back to factory setting. see page 23.
- Owner ID** Allows you to enter a security code and address information. see page 24.



Pressing  after having adjusted some feature will store the setting as the default (replacing the factory setting).

Tuning menu

Programme edit

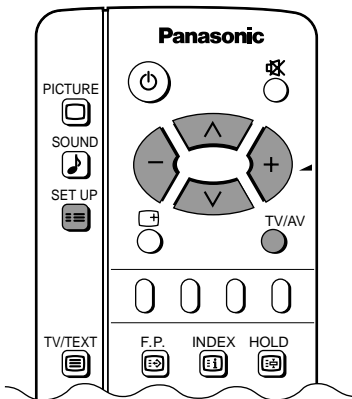

- 1 Press .
- 2 Move to the Tuning menu option by using or .
- 3 Access Tuning menu by using or .
- 4 Move to chosen menu option by using or .
- 5 Access Programme edit by using or .
- 6 Move to chosen Programme position by using or .

Make required change, eg: renaming a programme channel (see next page).

Press at any time to go back to watching TV.

Pressing after having adjusted some feature will store the change mode.

Adding / deleting a programme channel

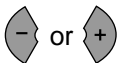

Make sure the cursor is in the **Prog.** column.

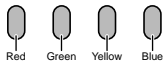

Press the green button to add a programme channel to the programme position, or the red button to delete one.

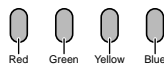

Press the same button again to confirm your decision.

Programme edit			
Prog.	Chan.	Name	Lock
1	CH44	ABCDE	Off
2	CH51	VWXYZ	Off
3	CH41	FTPES	Off
4	CH47	1 2 3 4 5	Off
5	CH37	4 5 6 7 8	Off

Buttons: Delete, Add, Move

Moving a programme channel

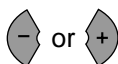

Make sure the cursor is in the **Prog.** column.

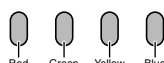

Press the yellow button.



Choose the new position for the programme channel.

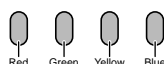

Press the yellow on screen selector key again to confirm your decision.

Programme edit			
Prog.	Chan.	Name	Lock
1	CH44	ABCDE	Off
2	CH51	VWXYZ	Off
3	CH41	FTPES	Off
4	CH47	1 2 3 4 5	Off
5	CH37	4 5 6 7 8	Off

Buttons: Delete, Add, Move

Tuning menu

Renaming a programme channel

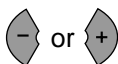

Move to the **Name** column.

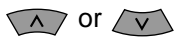

Choose the new character. The box at the bottom of the screen shows the character currently selected.

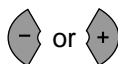

Move to the next character position. Continue until renaming is done.

Press  to store the new name.

Programme edit			
Prog.	Chan.	Name	Lock
1	CH44	ABCDE	Off
2	CH51	VWXYZ	Off
3	CH41	FTPES	Off
4	CH47	1 2 3 4 5	Off
5	CH37	4 5 6 7 8	Off

ABCDEFGHIJKLMNQRST
UVWXYZ+- . 0 1 2 3 4 5 6 7 8 9

Locking a programme channel

You may wish to lock a programme channel to prevent access to it

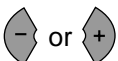

Move to the **Lock** column.

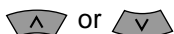

Choose between Lock **On** or Lock **Off**.

Press  to store the new setting

Programme edit			
Prog.	Chan.	Name	Lock
1	CH44	ABCDE	Off
2	CH51	VWXYZ	Off
3	CH41	FTPES	Off
4	CH47	1 2 3 4 5	Off
5	CH37	4 5 6 7 8	Off

Note:

- When a programme position is locked, Direct Channel Access using the **C** and numeric buttons on the remote control is not available.

Tuning menu

Auto setup

Auto setup automatically retunes your TV. This feature is useful if, for example, you move house and wish to retune your TV to receive the local stations.

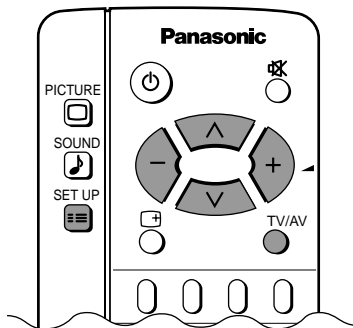

- 1 Press .
- 2 Move to the Tuning menu option by using or .
- 3 Access Tuning menu by using or .
- 4 Move to chosen menu option by using or .
- 5 Access Auto setup by using or .

Notes:

- If you proceed with the next step all tuning data will be erased (all stations and their programme positions stored in your TV's memory will be wiped out so the new settings can be stored).
- If an auto setup process is aborted midway, all channels that have been set up to that point will be saved to memory.

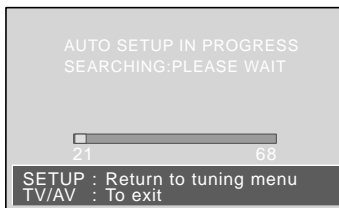
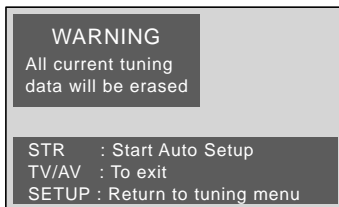

- 6 Start Auto setup by using .

Once this operation is completed the TV will display the programme now stored on programme position 1.

Press at any time to go back to watching TV (please read the **Note** in the above procedure).

Tuning menu

Manual tuning

It is possible to retune an individual programme position:

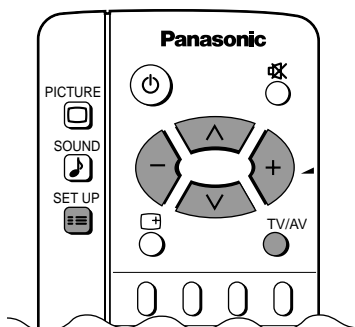

- 1 Press .
- 2 Move to chosen menu option by using or .
- 3 Access Tuning menu by using or .
- 4 Move to chosen menu option by using or .
- 5 Access Manual tuning by using or .
- 6 Select the programme position to be tuned by using or .
- 7 Press repeatedly until required station is found by using or .

When the desired station is found, press to store.
The program position will flash.

Press at any time to go back to watching TV.

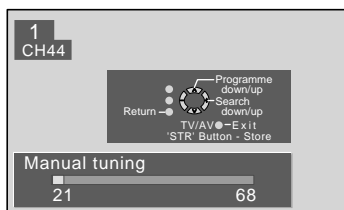

Manual tuning (via side panel)

It is also possible to use the control panel buttons on the side of your TV to tune individual programme positions:

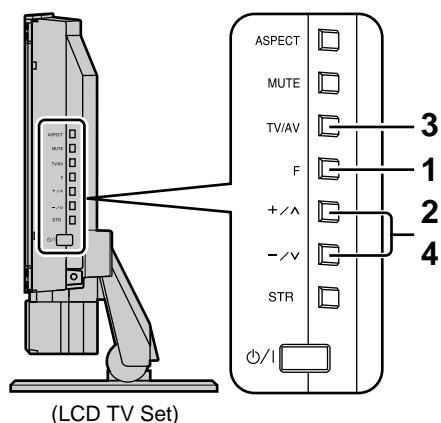

(LCD TV Set)

- 1 Press (Side panel) until Tuning mode is reached.
- 2 Press or to access Tuning mode.
- 3 Press to move between Change programme and search.
- 4 Press or to change programme position or start search.

When the desired station is found, press to store.

The programme position will flash.

Repeat above procedure to tune additional programme positions.

Press at any time to exit the Tuning menu.

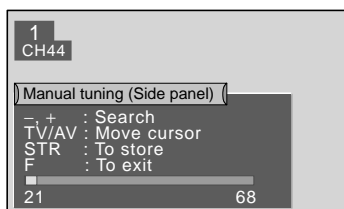

Tuning menu

Shipping condition







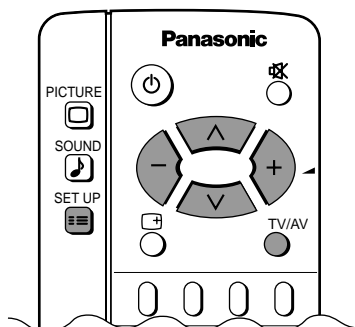

Shipping condition allows you to reset the TV to its original condition, i. e. no channels tuned in. This is useful, for example, if you move to a different area when you will probably want the TV to tune itself to your new local stations.



This can be done either through the **Shipping condition** menu or through the **Auto setup** menu.

The **Shipping condition** menu will reset all data, Clearing all tuning information and resetting all control levels back to factory setting.

You may need to adjust your VCR or programme position '0' VCR after operating the **Shipping condition** menu - refer to page 27.



- 1 Press  .
- 2 Move to chosen Tuning menu option by using  or  .
- 3 Access Tuning menu by using  or  .
- 4 Move to chosen menu option by using  or  .
- 5 Access Shipping condition by using  or  .

- 6 Press the  key twice.
A confirmation message is displayed twice.
Press the  key a third time, and all the tuning data will be cleared into the default setting.

Press  at any time to go back to watching TV.

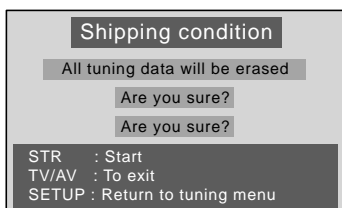
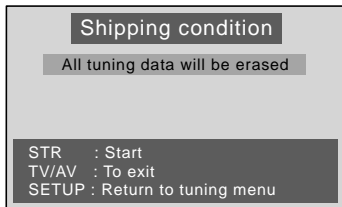

Tuning menu

Owner ID

Owner ID allows you to enter a security code (Owner ID) and personal details into its memory, so that in the unfortunate event of theft it will help the police to trace the owner.

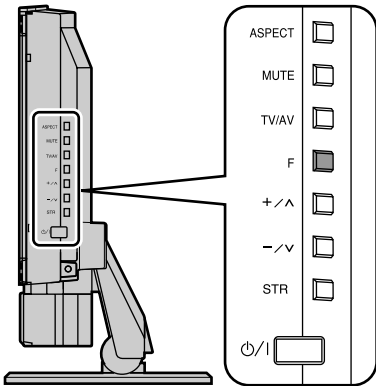

If you wish to check the personal details already entered into the TV, press the **F** (Side panel) and hold for 5 seconds. The details already entered are displayed on screen.

If **Owner ID** information was not entered when you switched on your TV for the first time or it is necessary to alter some of the information, **Owner ID** can be re-accessed via the **Tuning menu**.

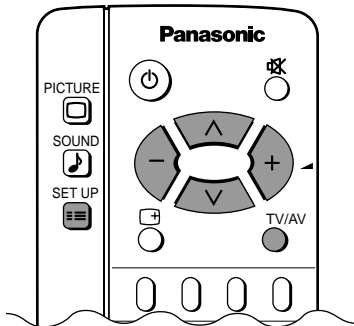

- 1 Press **SET UP**.
- 2 Move to chosen Tuning menu option by using **▲** or **▼**.
- 3 Access chosen Tuning menu by using **◀** or **▶**.
- 4 Move to chosen menu option by using **▲** or **▼**.
- 5 Access Owner ID by using **◀** or **▶**.

If the **Owner ID** has previously been set, enter the **PIN NUMBER** (using 0 to 9 on the remote control) followed by **STR** to proceed, this will take you to the **NAME** option.

If no **Owner ID** has previously been set, enter the required 4 digit **Owner ID PIN NUMBER** (using 0 to 9 on the remote control)

If a 4 digit **PIN NUMBER** was entered above, you will be taken automatically to the **NAME** line.

If not, move to the **NAME** line by using **◀** or **▶**.

Change character by using **▲** or **▼**.

Select character position by using **◀** or **▶**.

Repeat above until **NAME**, **HOUSE NUMBER** and **POSTCODE** are entered.

Press **STR** to store the details.

Press again when you are asked, "Are you sure?"

The **Tuning menu** will be displayed.

Press the **TV/AV** to exit.

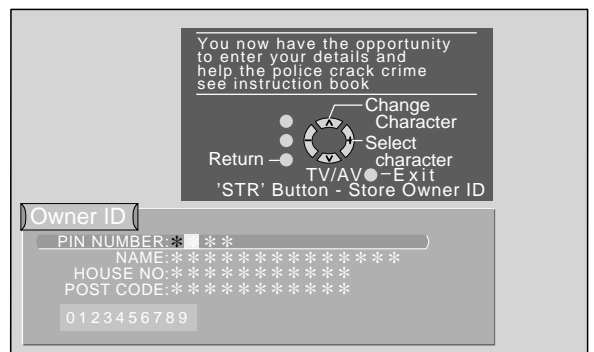
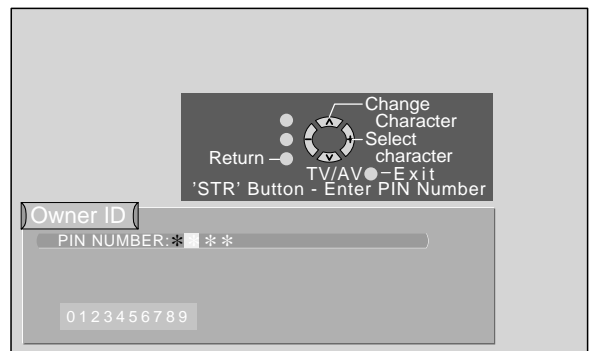

For future reference,
write your **PIN NUMBER** here :

Aspect Controls

Press the **ASPECT**  to move through the five aspect options: **Panasonic Auto, 4:3, Zoom, 16:9 and 14:9.**

Notes:

- If you leave Aspect set to Panasonic Auto, the TV software determines the best ratio for each programme viewed. In order not to disrupt your viewing, no mode information is displayed while this is happening. Simply press the ASPECT button to display mode information in the top left of the screen.
- The screen modes (4:3/Zoom/16:9/14:9) are selectable manually (wide-aspect modes are not automatically selected if a wide-screen signal is applied).
- During Aspect change, the displayed picture will momentarily disappear. This is not a malfunction.

The on screen selector keys (corresponding to the two coloured buttons on the remote control) that appear for some Aspect functions clear after a few seconds, if you want to select an operation when the keys are not shown, press the **ASPECT**  button once more and the keys will reappear.

Panasonic Auto

Panasonic Auto determines the best aspect ratio to use to display the picture you are viewing. It does this using a four step process to determine if the picture being viewed is a widescreen picture.

If **Panasonic Auto** detects a widescreen signal it switches into the appropriate **16:9** or letterbox **14:9** mode. The Panorama (Just) mode is selected if a signal with wide aspect ratio is not present (the screen cannot be switched from Panorama mode into 4:3 mode).

The text shown on the screen indicates how **Panasonic Auto** determined which ratio to use:

'WIDE' appears in the top left of the screen if a widescreen identification signal (WSS) is found or a signal is found through a Scart socket. **Panasonic Auto** switches to the appropriate **16:9** or **14:9** widescreen ratio. 'Panasonic Auto' appears in the top left of the screen if black stripes above and below the picture are detected. **Panasonic Auto** chooses the best ratio and expands the picture to fill the screen. This process can take several minutes, depending how dark the picture is.

When in Panasonic Auto mode, if a Letter box signal is input and there is no Aspect information, the picture is automatically adjusted to 14:9 or Zoom.

When "Panasonic Auto" is indicated in the top left of the picture and the subtitle is indicated in the lower part, the position of the picture can be adjusted vertically using the Yellow (V-POS-: Downwards) or Blue (V-POS+: Upwards) Buttons.

Notes:

- If, in Panasonic Auto mode, you experience problems with the screen display size when playing back widescreen format recordings from your VCR then it is possible that the tracking control your VCR requires adjustment (your VCR instruction book will contain adjustment details).
- The widescreen aspect ratios of different films and programmes can vary. If these are wider than a standard 16:9 aspect picture then a black band may be visible at the top bottom of the screen.



Panasonic Auto

'WIDE' appears in the top left of the screen, **Panasonic Auto** switches to the appropriate 16:9 or 14:9 widescreen ratio.



Panasonic Auto

'Panasonic Auto' appears in the top left of the screen. The best ratio is chosen and the picture expanded to fill the screen.

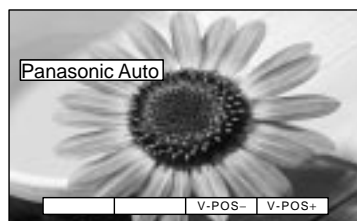

Panasonic Auto

Aspect Controls

4:3

4:3 will display a 4:3 picture at its standard 4:3 size without any stretching. Black stripes will be visible down the left and right sides of the picture.



4 : 3

Zoom

Zoom mode magnifies the central section of the picture.

Press the yellow or blue buttons to move the picture vertically (useful when there are sub-titles positioned below the picture).

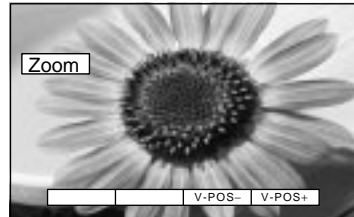

Zoom

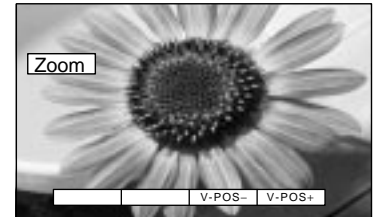

Blue button has been pressed to move picture upwards

16:9

16:9 will display the picture at its maximum size but with slight stretching.

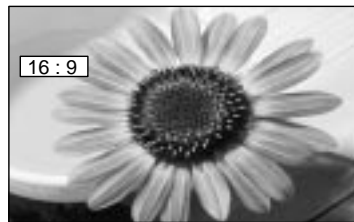

16 : 9

14:9 Letterbox

14:9 will display a 14:9 picture at its standard 14:9, size without any stretching. Black stripes will be visible down the left and right sides of the picture.

Press the yellow or blue buttons to move the picture vertically.

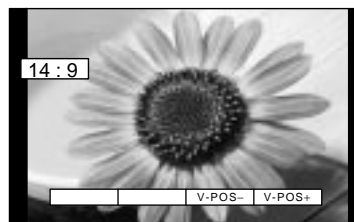

14 : 9

Tuning your VCR and satellite receiver









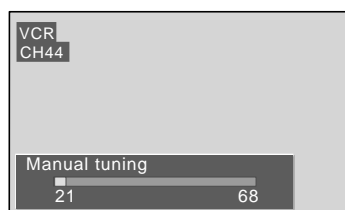
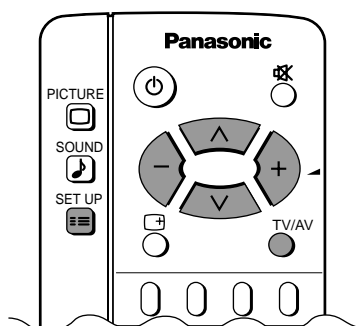



Your new TV is supplied with programme position '0' set to receive an RF signal from your VCR, although a Scart connection is preferable if the VCR is so equipped (see page 6 or 32 for suitable inputs to the Scart socket on this TV.)

However, if for some reason your VCR is tuned to a different RF channel then you will not receive any picture or sound from your VCR on programme position '0' of the TV. Either adjust the tuning of the TV's programme position '0' (follow the instructions below) or adjust the RF channel of your VCR (some VCRs allow adjustment of their RF channel via their remote control unit) or both until the TV receives the RF output channel of your VCR. It is intended that this advice is used in conjunction with the instruction books for your additional equipment.

Tuning your TV to the VCR.

Switch on the VCR, insert and play a pre-recorded tape with known content



- 1 Press  .
- 2 Move to chosen Tuning menu option by using  or  .
- 3 Access Tuning menu by using  or  .
- 4 Move to chosen Manual tuning by using  or  .
- 5 Access Manual tuning by using  or  .
- 6 Select programme position '0' VCR by using  or  .
- 7 Start searching for the VCR playback of the known content tape by using  or  .

When the VCR playback is found, press  to store.

Pressing  to exit.



The tape with known content is found and displayed.

Pressing  will store the setting.

Notes:

- If picture patterning occurs on programme position '0' it may be necessary to adjust the RF output channel of the VCR, refer to the VCR instruction book.
- If a Satellite Receiver and a VCR are going to be used with RF cable connections it is important to avoid both units being set on the same channel. Refer to the Satellite Receiver and VCR instruction books for precise tuning information.

Advanced Remote Control Operation

VCR / DVD Operation

The Remote Control is capable of operating some functions of selected Panasonic VCRs and DVD (Digital Versatile Disc) equipment. Some VCR and DVD equipment have different functions, so to ensure compatibility please refer to the equipment's instruction book or consult your dealer for details.

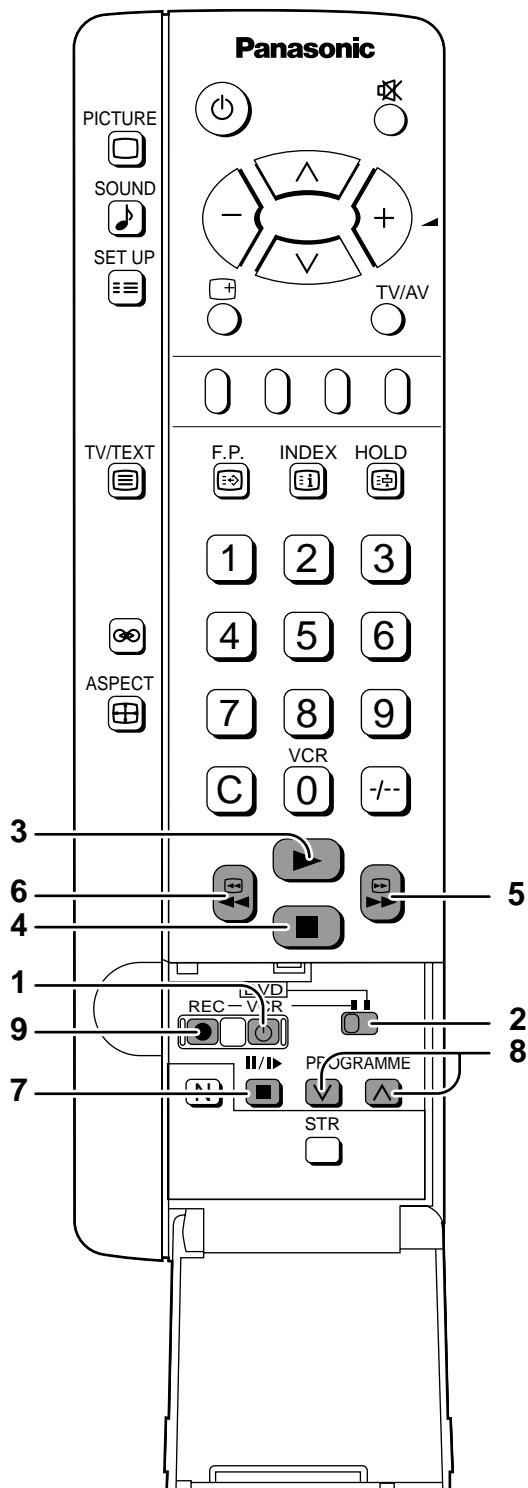



Button		Function
1		Standby Press to switch the VCR or DVD to standby mode. Press again to switch back on.
2		VCR / DVD switch Use this switch to select whether controls operate DVD equipment or your VCR.
3		Play Press to playback the tape or DVD.
4		Stop Press to stop the tape or DVD.
5		Skip / Fast Forward / Cue VCR: Press to fast forward the tape. In Play mode, press to view the picture rapidly forward (Cue). DVD: Press once to skip to the next track.
6		Skip / Rewind / Review VCR: Press to rewind the tape. In Play mode, press to view the picture rapidly in reverse (Review). DVD: Press once to skip to the previous track.
7		Pause / Still Press in playback mode, the picture will pause. Press again to restart play.
8		Programme Up / Down Press to increase or decrease the VCR programme position by one.
9		Record Press this button to start recording.

Advanced Remote Control Operation

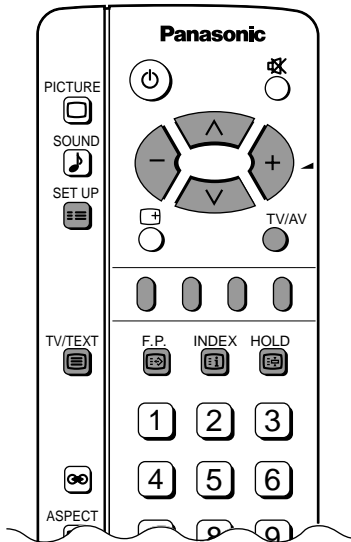
TELETEXT



- Teletext features may vary depending on the Broadcasting Companies and is only available if the channel selected is transmitting Teletext.
- Pressing the Picture button whilst in Teletext operation will display the contrast

function with a cyan bar, press  or  to alter the setting as required.

Pressing the Setup button whilst in Teletext operation will display special function options at the bottom of the screen.

- When in Teletext mode, the volume may still be altered to the desired listening level, after pressing SOUND or MUTE button first.

What is List mode?

In List mode, four different coloured page numbers are situated at the bottom of the screen. Each of these numbers can be altered and stored in the LCD TV's memory.

What is Fastext?

In Fastext mode, four differently coloured subjects are situated at the bottom of the display. To access more information about one of these subjects, press the appropriately coloured button. This facility enables fast access to information on the subjects shown.

Note:

- When watching TV in 4:3, 14:9 or zoom mode, pressing TV/TEXT button will display teletext page momentarily in that aspect before switching to normal teletext picture size.



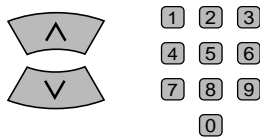

TV / Teletext mode

Press  to switch between the current programme and teletext mode.



Page Selection

Pages can be selected in two ways:

- Press  or  to increase or decrease the page number by one.
- By entering the page number, using 0 -9 on the remote control.



Full / Top / Bottom

Press  to display special functions, followed by the **Green** button. Press the **Green** button again to expand the BOTTOM half. Press again to return to normal (FULL) size.



Reveal

Press  to display special functions, followed by the **Red** button to reveal hidden words e.g. quiz page answers. Press again to hide.

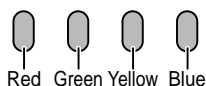

Red / Green / Yellow / Blue buttons

In Fastext mode these correspond to the differently coloured subjects. In List mode they correspond to the differently coloured page numbers.

Advanced Remote Control Operation

It is not possible to change the programme position when in News flash, Update or Sub Coded Page Access operation.

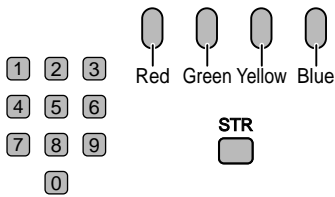

List Store

In List mode the four page numbers can be altered (programme positions 1 - 25 only). To do this, press one of the four coloured buttons and enter the new page number. Press and hold , the page numbers will change to white indicating that the page is stored.



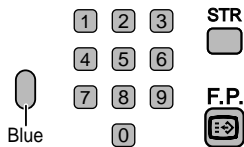

Hold

To hold the Teletext page when viewing multi-page information. Press again to return to automatic page update.





Favourite Page (F.P.)

Stores a favourite page in memory for instant recall. To store such a page, the TV must be in List mode, and the programme position must be from 1 - 25. Press the **Blue** button, select the page number, then press and hold . The page number is now stored. Press  to recall this page.

Note:

If Teletext subtitling is in use, the aspect ratio is set to 16:9.

Update Display

Press  to display special functions, followed by the **Yellow** button to view the TV picture whilst searching for a Teletext page. When found, the screen will display the page number at the top left. Press the **Yellow** button to view the page. Press  again to return to normal TV operation.

News Flash

When a news flash page has been selected, press , **Yellow**, to view the TV picture. When an update is received, the page number will be displayed on screen.

Press the **Yellow** button to display the News Flash.

Press  to return to normal TV operation.



Update

Press , **Yellow** to see the update of information on certain pages.

When an update is received, the page number will be displayed at the top left of the screen.

Press the **Yellow** button to view the page.

Press  to return to normal TV operation.

Index

When in Fastext operation

Press  to return to the main index page.

Depending on the way information is transmitted, this may have to be pressed more than once to return to the main index page.



Advanced Remote Control Operation

SET UP

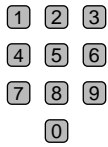



Sub Coded Page Access

When Teletext information exceeds more than one page, it may take some time for the automatic changing of the sub pages to reach the sub page you require. It is possible to enter your required sub page and continue watching the normal programme until the correct sub page is found.

Select the required page number using buttons 0 - 9.

If the top of the page indicates that sub pages are being transmitted yet the page does not change, then the number at the top of the page is there to indicate that the broadcaster has updated the page's contents, there are no sub pages.



Press ^{SET UP} followed by the **Blue** button; T**** will be displayed at the top right of the screen.

Enter desired sub page number before the T**** disappears. To select page 6 enter 0, 0, 0 and 6. (If in List mode, a 'T' will appear in the current box at the bottom).

(Press ^{SET UP}, **Yellow** in List mode).

When the page is available, press the **Yellow** button to view the page.

To clear the page perform one of the following:

- Press ^{SET UP}.
- Select a new page number.
- Press ^{TV/TEXT} to return to normal TV operation.

Note:

When using subtitles, the picture brightness may vary to a preset level.

Connections

How to connect the input terminals

Connects VCRs and other peripheral equipment

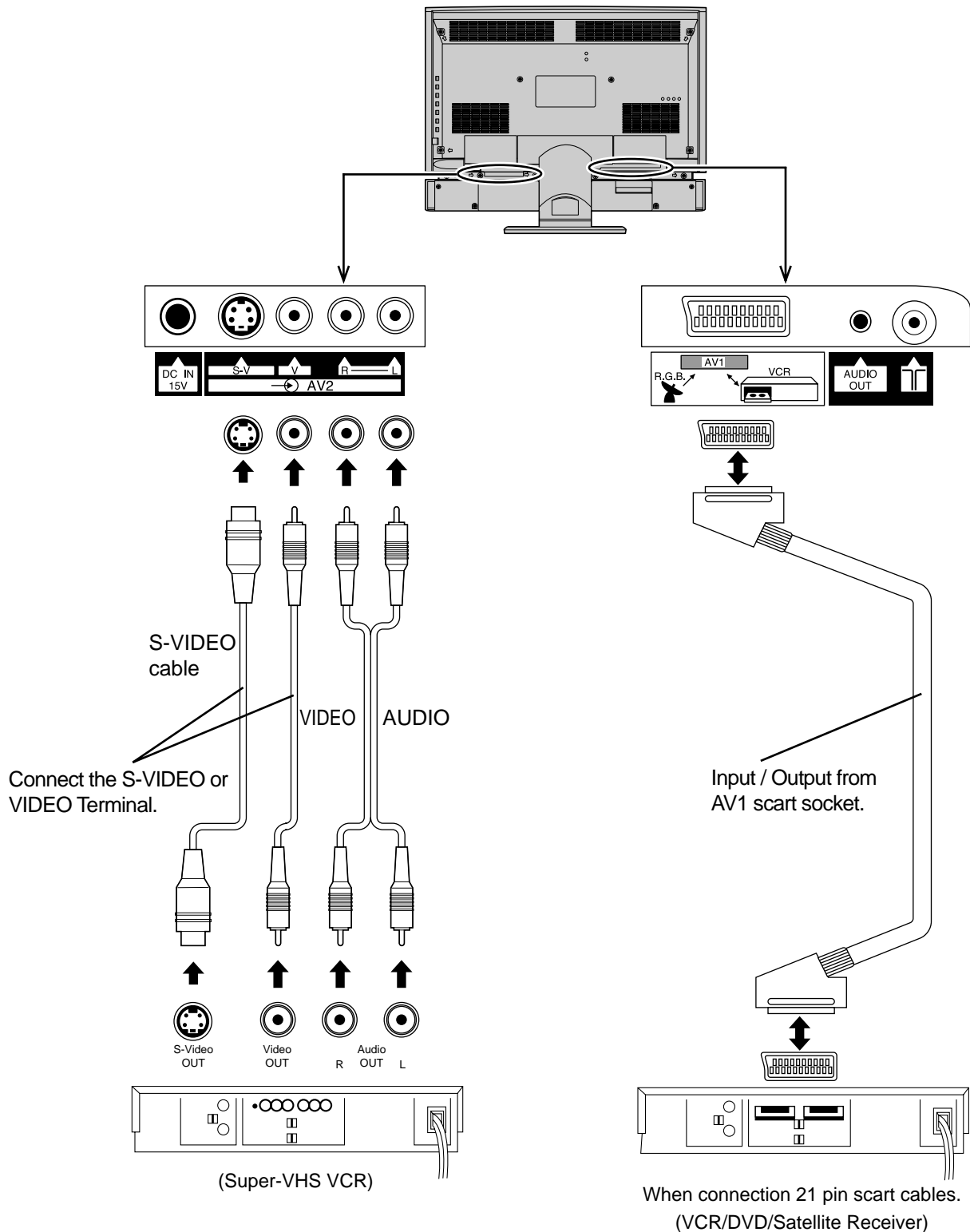

Notes:

- Additional equipment and cables shown are not supplied with this TV set.
- When a monaural VCR is used, connect the monaural audio cable to the AUDIO-L (Left) terminal.
- Do not connect a computer with TTL output (5V) to this set.
- Select the desired VIDEO input position by pushing the TV/AV button. (see page 10)
- For Scart socket wiring information see page 35.

Connections

How to connect the AUDIO OUT Terminals

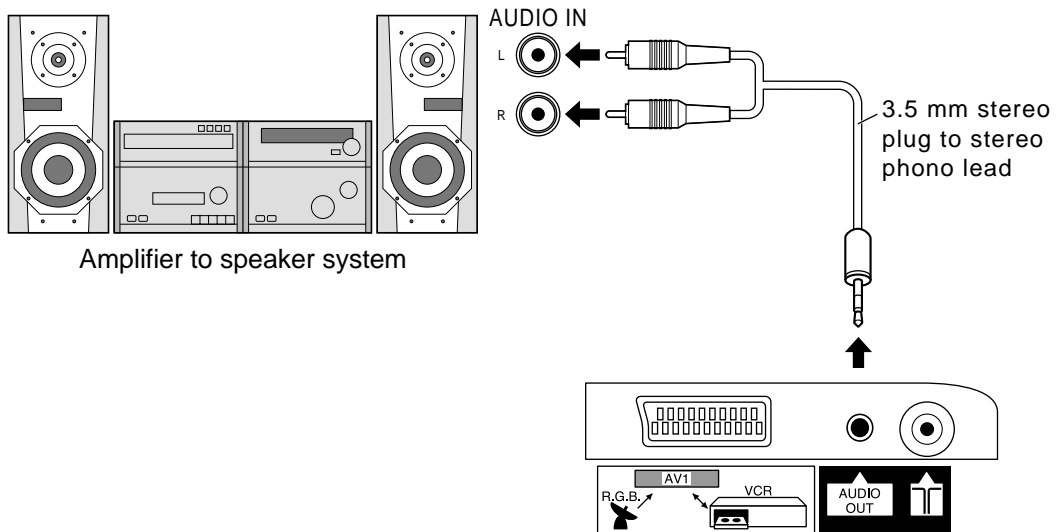

Note:

The AUDIO OUT terminal provides a fixed level output only.
(The menu settings and remote control volume controls have no effect.)

Connecting Headphones / Earphones

Connect headphones / earphones as follows.

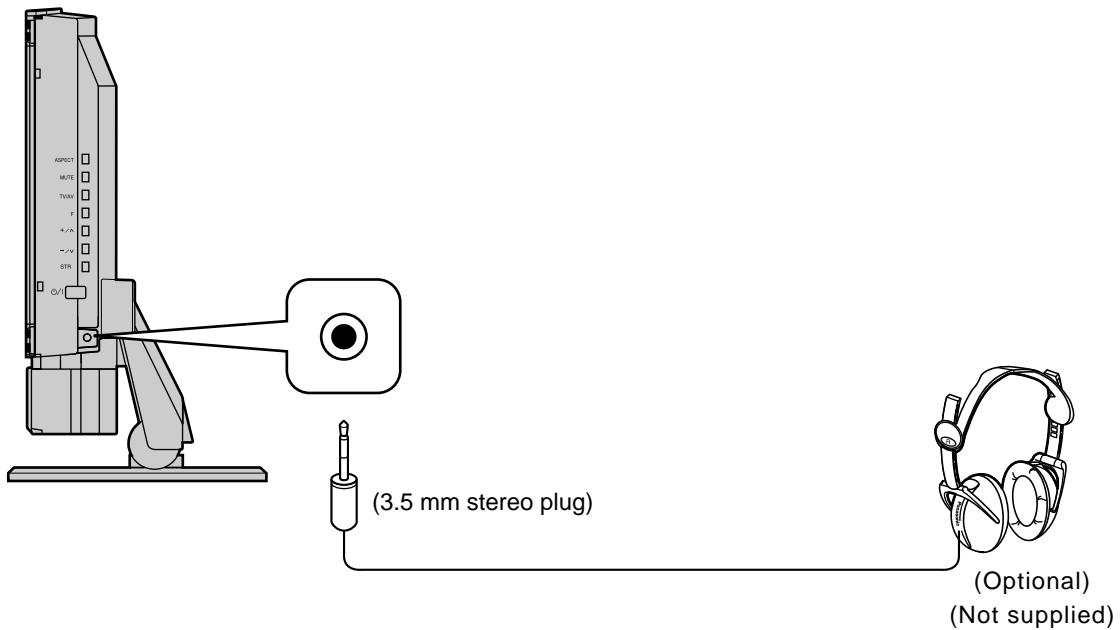









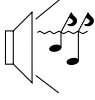

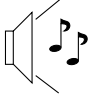

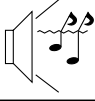

Note:

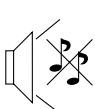
The volume level of the headphones can be adjusted by selecting "Headphone Volume" from the Sound menu.
Additional equipment and cables shown are not supplied with this TV set.

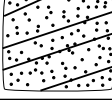
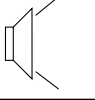
Troubleshooting

If there is a problem with your LCD TV please refer to the table below to determine the symptoms, then carry out the suggested check. If this does not solve the problem, please contact your local Panasonic dealer, quoting the model number and serial number (both found on the rear of the TV).

Symptoms		Checks
Picture	Sound	
 Snowy Picture	 Noisy Sound	Aerial location, direction or connection
 Multiple Image	 Normal Sound	Aerial location, direction or connection
 Interference	 Noisy Sound	Electrical appliances Cars/Motorcycles Fluorescent lights
 Normal Picture	 No Sound	Volume level Sound mute switched on
 No Picture	 No Sound	TV set to AV mode Not plugged into A.C. outlet Not switched on Picture / Sound controls set at minimum levels Check if in stand-by mode
 No Colour	 Normal Sound	Colour Controls set at minimum levels
 Poor or Distorted Picture	 Weak or No Sound	Retune Channel (s)
 Normal Picture	 Weak or distorted sound	Sound reception may have deteriorated. Switch NICAM setting (Sound menu) to Off until reception improves.
There may be red spots, blue spots and green spots on the screen	 Normal Sound	This is a characteristic of liquid crystal panels and is not a problem. The liquid crystal panel is built with very high precision technology giving you fine picture details. Occasionally, a few non-active pixels may appear on the screen as a fixed point of blue, green, or red. Please note the this does not affect the performance of your LCD.

Maintenance

To clean this unit, wipe with a soft, dry cloth.

If the surfaces are extremely dirty, use a soft cloth dipped in soap-and-water solution or a weak detergent solution.

- Use eyeglass cleaner to remove stubborn dirt from the LCD.
- Never use alcohol, paint thinner or benzine to clean this unit.
- Before using chemically treated cloth, read the instructions that came with the cloth carefully.
- Do not wipe the LCD with water.

Wipe the cabinet with a soft cloth

If the cabinet is heavily soiled, wipe with a well-wrung soft cloth dipped in kitchen cleanser (neutral) diluted with water.

CAUTION :

If water or similar substances get inside the monitor via the liquid crystal panel surface, a malfunction may result.

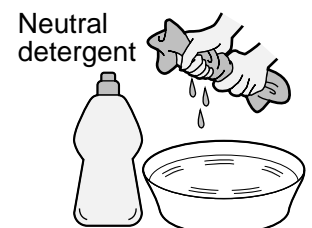

Specifications

Scart and S-video socket information

AV1 Scart socket

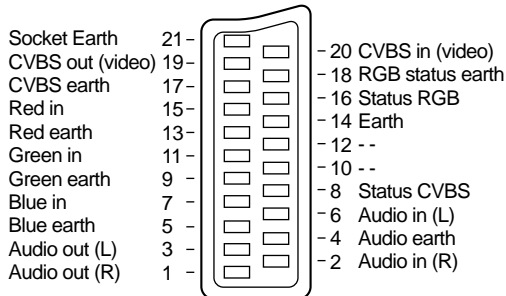

AV2 S-Video 4 pin socket

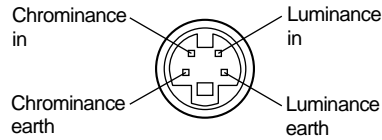

Power Source		AC 100 ~ 240 V, 50 / 60 Hz	
Power Consumption		Average use : 49 W Stand-by condition : 4 W	TV set DC 15 V, 2.8 A max.
LCD		15.2-inch (385 mm) 16 : 9 aspect ratio LCD panel	
Screen Size		13.21 " (335.6 mm) (W) × 7.43 " (188.6 mm) (H)	
Channel Capability-100		UHF : 21-68	
Sound	Speaker	Tweeter (3 × 4 cm 2pcs, 8 Ω), Woofer (φ 5 cm , 8 Ω)	
	Audio Output	6.5W (2.0 W + 2.0 W + 2.5 W (Woofer)), 10 % THD,	
	Headphones	M3 (3.5 mm) Jack × 1 8 Ω impedance	
FEATURES		Aero - Hammer® Woofer System (2 Way 3 Speaker System)	
Receiving Systems/ Band name		PAL UHF E21 - 68 PAL 525/60 Playback of NTSC tape from some PAL video recorders (VCR) M.NTSC Playback from M.NTSC Videorecorders (VCR) NTSC Playback from NTSC Videorecorders (VCR)	
Aerial - Rear		UHF	
Operating Conditions		Temperature : 41 °F - 95 °F (5 ° - 35 °C) Humidity : 5 % - 90 % RH (non-condensing)	
Connection Terminals			
AV1		21 Pin socket (Audio / Video in , Audio / Video out , RGB in)	
AV2	VIDEO	RCA PIN Type × 1	
	S-VIDEO	Mini DIN 4-pin	
AUDIO OUT		3.5 mm, Stereo Jack	0.5 Vrms
Dimensions (W × D × H)			
Including TV Stand		16.26 " (413 mm) × 7.09 " (180 mm) × 12.99 " (330 mm)	
TV Set Only		16.26 " (413 mm) × 2.44 " (62 mm) × 11.61 " (295 mm)	
Weight (Mass)		12.35 lb. (5.6 kg) Net	

Note:

Design and Specifications are subject to change without notice. Weight and Dimensions shown are approximate.

Customer' Record

The model number and serial number of this product can be found on its rear panel. You should note this serial number in the space provided below and retain this book, plus your purchase receipt, as a permanent record of your purchase to aid in identification in the event of theft or loss, and for Warranty Service purposes.

Model Number TX-15LT2

Serial Number _____

Panasonic (U. K.) Ltd.
Willoughby Road, Bracknell, Berks RG12 8FP
Web Site <http://www.panasonic.co.uk>