

Panasonic®

Progressive Plasma Television Operating Instructions

Model No. **TH-37PA20**
TH-42PA20
TH-42PA25



For assistance, please call : 1-888-VIEW-PTV(843-9788)
or send e-mail to : consumerproducts@panasonic.com
or visit us at www.panasonic.com (U.S.A)

For assistance, please call : 787-750-4300
or visit us at www.panasonic.com (Puerto Rico)

For assistance, please call : 1-800-561-5505
or visit us at www.panasonic.ca (Canada)

Before connecting, operating or adjusting this product, please read these instructions completely.
Please keep this manual for future reference.

	WARNING RISK OF ELECTRIC SHOCK DO NOT OPEN	
WARNING: To reduce the risk of electric shock, do not remove cover or back. No user-serviceable parts inside. Refer servicing to qualified service personnel.		



The lightning flash with arrow-head within a triangle is intended to tell the user that parts inside the product are a risk of electric shock to persons.



The exclamation point within a triangle is intended to tell the user that important operating and servicing instructions are in the papers with the appliance.

WARNING: To reduce the risk of fire or electric shock, do not expose this apparatus to rain or moisture. Do not place liquid containers (flower vase, cups, cosmetics, etc.) above the set. (including on shelves above, etc.)

WARNING: 1) To prevent electric shock, do not remove cover. No user serviceable parts inside. Refer servicing to qualified service personnel.
2) Do not remove the grounding pin on the power plug. This apparatus is equipped with a three pin grounding-type power plug. This plug will only fit a grounding-type power outlet. This is a safety feature. If you are unable to insert the plug into the outlet, contact an electrician. Do not defeat the purpose of the grounding plug.

Note:
Do not allow a still picture to be displayed for an extended period, as this can cause a permanent after-image to remain on the Plasma television.
Examples of still pictures include logos, video games, computer images, teletext and images displayed in 4:3 mode.

Trademark Credits

- VGA is a trademark of International Business Machines Corporation.
- Macintosh is a registered trademark of Apple Computer, USA.
- S-VGA is a registered trademark of the Video Electronics Standard Association.

Even if no special notation has been made of company or product trademarks, these trademarks have been fully respected.



Manufactured under license from BBE Sound, Inc.
Licensed by BBE Sound, Inc. under USP4638258, 5510752 and 5736897.
BBE and BBE symbol are registered trademarks of BBE Sound, Inc.

Important Safety Instructions

- 1) Read these instructions.
All the safety and operating instructions should be read before the appliance is operated.
- 2) Keep these instructions.
The safety and operating instructions should be retained for future reference.
- 3) Heed all warnings.
All warnings on the appliance and in the operating instructions should be adhered to.
- 4) Follow all instructions.
All operating and use instructions should be followed.
- 5) Do not use this apparatus near water.
For example, near a bathtub, wash bowl, kitchen sink, or laundry tub, in a wet basement, or near a swimming pool, and the like.
- 6) Clean only with dry cloth.
Do not use liquid cleaners or aerosol cleaners. Use a dry cloth for cleaning.
- 7) Do not block any ventilation openings. Install in accordance with the manufacturer's instructions.
Slots and Openings in the cabinet are provided for ventilation and to ensure reliable operation of the product and to protect it from overheating. The openings should never be blocked by placing the product on a bed, sofa, rug, or other similar surface.
- 8) Do not install near any heat sources such as radiators, heat registers, stoves, or other apparatus (including amplifiers) that produce heat.
This product should not be placed in a built-in installation such as a bookcase or rack unless proper ventilation is provided or the manufacturer's instructions have been adhered to.
- 9) Do not defeat the safety purpose of the polarized or grounding-type plug. A polarized plug has two blades with one wider than the other. A grounding type plug has two blades and a third grounding prong. The wide blade or the third prong are provided for your safety. If the provided plug does not fit into your outlet, consult an electrician for replacement of the obsolete outlet.
- 10) Protect the power cord from being walked on or pinched particularly at plugs, convenience receptacles, and the point where they exit from the apparatus.
- 11) Only use attachments / accessories specified by the manufacturer.
- 12) Use only with the cart, stand, tripod, bracket, or table specified by the manufacturer, or sold with the apparatus. When a cart is used, use caution when moving the cart / apparatus combination to avoid injury from tip-over.
Quick stops, excessive force, and uneven surfaces may cause the appliance and cart combination to overturn.
- 13) Unplug this apparatus during lightning storms or when unused for long periods of time.
This will prevent damage to the product due to lightning and power-line surges.
- 14) Refer all servicing to qualified service personnel. Servicing is required when the apparatus has been damaged in any way, such as power-supply cord or plug is damaged, liquid has been spilled or objects have fallen into the apparatus, the apparatus has been exposed to rain or moisture, does not operate normally, or has been dropped.
- 15) To prevent electric shock, ensure the grounding pin on the AC cord power plug is securely connected.



Dear Panasonic Customer

Welcome to the Panasonic family of customers. We hope that you will have many years of enjoyment from your new Plasma TV.

To obtain maximum benefit from your set, please read these Instructions before making any adjustments, and retain them for future reference.

Retain your purchase receipt also, and record the model number and serial number of your set in the space provided on the back cover of these instructions.

Visit our Panasonic Web Site for USA : www.panasonic.com
for Puerto Rico : www.panasonic.com
for Canada : www.panasonic.ca

For assistance, please call : 1-888-VIEW-PTV(843-9788) or send e-mail to : consumerproducts@panasonic.com or visit us at www.panasonic.com (U.S.A)
For assistance, please call : 787-750-4300 or visit us at www.panasonic.com (Puerto Rico)
For assistance, please call : 1-800-561-5505 or visit us at www.panasonic.ca (Canada)

FCC STATEMENT:

NOTE: This equipment has been tested and found to comply with the limits for a Class B digital device, pursuant to Part 15 of the FCC Rules. These limits are designed to provide reasonable protection against harmful interference in a residential installation. This equipment generates, uses and can radiate radio frequency energy and, if not installed and used in accordance with the instructions, may cause harmful interference to radio communications. However, there is no guarantee that interference will not occur in a particular installation. If this equipment does cause harmful interference to radio or television reception, which can be determined by turning the equipment off and on, the user is encouraged to try to correct the interference by one or more of the following measures:

- Reorient or relocate the receiving antenna.
- Increase the separation between the equipment and receiver.
- Connect the equipment into an outlet on a circuit different from that to which the receiver is connected.
- Consult the dealer or an experienced radio/TV technician for help.

This device complies with Part 15 of the FCC Rules. Operation is subject to the following two conditions: (1) This device may not cause harmful interference, and (2) this device must accept any interference received, including interference that may cause undesired operation.

FCC CAUTION:

To assure continued compliance and possible undesirable interference, the provided ferrite cores must be used when connecting this plasma television to video equipment; and maintain at least 40cm spacing to other peripheral devices. Refer to instructions on pages 9, 10, 11, 12, 13, 14, 17, 18 and 19.

Any changes or modifications to this TV not expressly approved by Matsushita Electric Corporation of America could result harmful interference and would void the user's authority to operate this device.

FCC Declaration of Conformity

Model No. TH-37PA20



TH-42PA20

TH-42PA25

Responsible Party: Matsushita Electric Corporation of America
One Panasonic Way, Secaucus, NJ 07094
Contact Source: Panasonic Consumer Electronics Company
1-888-843-9788
email: consumerproducts@panasonic.com

CANADIAN NOTICE: For Models TH-37PA20 and TH-42PA20
This Class B digital apparatus complies with Canadian ICES-003.

Table of Contents

Important Safety Instructions	3	SURROUND	32
FCC STATEMENT	4	SPEAKERS	32
Safety Precautions	6	CHANNELS Adjustment	33
Installation	8	CHANNEL SCAN	33
Receiver Location	8	FAVORITE CHANNELS Selection	33
Optional External Equipment	8	Selecting option menus in OTHER ADJ.	34
Remote Control Battery Installation	8	PRESET CAPTION	34
Accessories	9	MANUAL CAPTION	35
Cable Connection	10	INPUT LABEL	35
Antenna Connection	11	TIMER	36
Connecting Headphones / Earphones	11	SLEEP	36
Front Control Panel	12	TIMER1 and TIMER2	36
Optional Equipment Connections	12	CLOCK SET	38
Cable Box Connection	12	LOCK Feature	39
VCR Connection	13	CREATE CODE FIRST	39
VCR and Cable Box Connection	14	CODE	39
Digital TV - Set-Top Box (DTV-STB) or DVD Connection ..	15	LOCK SET	39
Amplifier Connection (TO AUDIO AMP)	15	CHANNEL	40
Program Out Connection (PROG OUT)	16	V-CHIP SET	40
How to connect the DIGITAL IN Terminals	16	U.S. TV PROGRAMS	41
Connecting a Digital Set-Top-Box to		U.S. MOVIES	42
DIGITAL IN	16	Canadian English	43
PC Input Terminals connection	17	Canadian French	44
Power ON / OFF	18	Blocking Message	45
AC cord connection	18	HOW LONG?	45
How to Turn the Power On	18	Picture in Picture Operation	46
Menu Language Selection	18	Split Screen	48
Cable TV / VHF, UHF and CATV	19	ASPECT Controls	50
Cable TV	19	PC MENU	51
VHF, UHF and CATV	19	PICTURE Adjustment	51
Location of Controls	20	Adjusting PICTURE POSITION/SIZE	52
Illuminated Remote Control	20	SYNC	53
Basic Menu Operations	22	H-FREQ. (kHz)/V-FREQ. (Hz)	53
SET UP Operation	24	Operating peripheral equipment using the remote control	54
MENU Languages	24	Programming The Illuminated Remote Control	
ANTENNA Selection	24	Using Access Codes	54
 ON MUTE  MODE (Closed Captions)	24	Programming Without A Code	
Selecting option menus in OTHER ADJ.	25	(When the code is not known)	55
MODE Selection	26	Infrared Codes Index	56
AUTO PROGRAM	26	Mode Operational Key Chart	59
MANUAL PROGRAM	26	Troubleshooting Chart	61
AUTO POWER ON	27	VIDEO/COMPONENT/PC/DVD input signals	62
CHAN BANNER	27	Specifications	63
SIDE BAR	27		
POWER SAVE	28		
PICTURE Adjustment	28		
PICTURE MODE	28		
COLOR / TINT / BRIGHTNESS / PICTURE /			
SHARPNESS / NORMAL	28		
Selecting option menus in OTHER ADJ.	29		
COLOR TEMP (Temperature) / NATURAL COLOR /			
VIDEO NR / 3D Y/C FILTER	29		
COLOR MATRIX	29		
FREEZE	30		
Audio Adjustment	31		
Selecting STEREO/SAP/MONO	31		
Selecting BASS / TREBLE / BALANCE / NORMAL	31		
Selecting option menus in OTHER ADJ.	31		
AI SOUND	31		
BBE VIVA / BBE	32		

Safety Precautions

WARNING

Set up

Do not place the Plasma TV on sloped or unstable surfaces.

- The Plasma TV may fall off or tip over.

Do not place any objects on top of the Plasma TV.

- If water spills onto the Plasma TV or foreign objects get inside it, a short-circuit may occur which could result in fire or electric shock. If any foreign objects get inside the Plasma TV, please consult an Authorized Service Center.

Do not cover the ventilation holes.

- Doing so may cause the Plasma TV to overheat, which can cause fire or damage to the Plasma TV.

If using the pedestal, leave a space of 3 15/16" (10 cm) or more at the top, left and right, 2 3/8" (6 cm) or more at the bottom, and 2 3/4" (7 cm) or more at the rear. If using some other setting-up method, leave a space of 3 15/16" (10 cm) or more at the top, bottom, left and right, and 3/4" (1.9 cm) or more at the rear.

Avoid installing this product near electronic equipment that easily receives electromagnetic waves.

- It may cause interference in image, sound, etc. In particular, keep video equipment away from this product.

AC Power Supply Cord

The Plasma TV is designed to operate on 120 V AC, 50/60 Hz.

Securely insert the power cord plug as far as it will go.

- If the plug is not fully inserted, heat may be generated which could cause fire. If the plug is damaged or the wall socket plate is loose, they should not be used.

Do not handle the power cord plug with wet hands.

- Doing so may cause electric shocks.

Do not do anything that might damage the power cable. When disconnecting the power cable, hold the plug, not the cable.

- Do not make any modifications, place heavy objects on, place near hot objects, heat, bend, twist or forcefully pull the power cable. Doing so may cause damage to the power cable which can cause fire or electric shock. If damage to the cable is suspected, have it repaired at an Authorized Service Center.

If the Plasma TV will not be used for a long period of time, unplug the power cord from the wall outlet.

If problems occur during use

If a problem occurs (such as no picture or no sound), or if smoke or an abnormal odor is detected from the Plasma TV, unplug the power cord immediately.

- Continuous use of the TV under these conditions might cause fire or permanent damage to the unit. Have the TV evaluated at an Authorized Service Center. Services to the TV by any unauthorized personnel are strongly discouraged due to its high voltage dangerous nature.

If water or foreign objects get inside the Plasma TV, if the Plasma TV is dropped, or if the cabinet becomes damaged, disconnect the power cord plug immediately.

- A short may occur, which could cause fire. Contact an Authorized Service Center for any repairs that need to be made.

CAUTION

This Plasma TV is for use only with the following optional accessories. Use with any other type of optional accessories may cause instability which could result in the possibility of injury.

(All of the following accessories are manufactured by Matsushita Electric Industrial Co., Ltd.)

- Pedestal (included) TY-ST42PA20
- Wall-hanging bracket (vertical) TY-WK42PV2W

Always be sure to ask a qualified technician to carry out set-up.

When using the Plasma TV

Do not bring your hands, face or objects close to the ventilation holes of the Plasma TV.

- Top of the Plasma TV is usually very hot due to the high temperature of exhaust air being released through the ventilation holes. Burns or personal injuries can happen if any body parts are brought too close. Placing any object near the top of the TV could also result in heat damages to the object as well as to the TV if its ventilation holes are blocked.

Be sure to disconnect all cables before moving the Plasma TV.

- Moving the TV with its cables attached might damage the cables which, in turn, can cause fire or electric shock.

Disconnect the power plug from the wall outlet as a safety precaution before carrying out any cleaning.

- Electric shocks can result if this is not done.

Clean the power cable regularly to prevent it from becoming dusty.

- Built-up dust on the power cord plug can increase humidity which might damage the insulation and cause fire. Unplug the cord from the wall outlet and clean it with a dry cloth.

This Plasma TV radiates infrared rays, therefore it may affect other infrared communication equipment.

Install your infrared sensor in a place away from direct or reflected light from your Plasma TV.

Cleaning and maintenance

The front of the display panel has been specially treated. Wipe the panel surface gently using only a cleaning cloth or a soft, lint-free cloth.

- If the surface is particularly dirty, soak a soft, lint-free cloth in a weak detergent solution and then wring the cloth to remove excess liquid. Use this cloth to wipe the surface of the display panel, then wipe it evenly with a dry cloth, of the same type, until the surface is dry.
- Do not scratch or hit the surface of the panel with fingernails or other hard objects. Furthermore, avoid contact with volatile substances such as insect sprays, solvents and thinner, otherwise the quality of the surface may be adversely affected.

If the cabinet becomes dirty, wipe it with a soft, dry cloth.

- If the cabinet is particularly dirty, soak the cloth in a weak detergent solution and then wring the cloth dry. Use this cloth to wipe the cabinet, and then wipe it dry with a dry cloth.
- Do not allow any detergent to come into direct contact with the surface of the Plasma TV. If water droplets get inside the unit, operating problems may result.
- Avoid contact with volatile substances such as insect sprays, solvents and thinner, otherwise the quality of the cabinet surface may be adversely affected or the coating may peel off. Furthermore, do not leave it for long periods in contact with articles made from rubber or PVC.

Note:

Do not allow a still picture to be displayed for an extended period, as this can cause a permanent after-image to remain on the Plasma TV.

Examples of still pictures include logos, video games, computer images, teletext and images displayed in 4:3 mode.

Installation

Receiver Location

This unit is intended to be used with an optional stand or entertainment center. Consult your dealer for available options. Locate for comfortable viewing. Avoid placing where sunlight or other bright light (including reflections) will fall on the screen. Use of some types of fluorescent lighting can reduce remote control transmitter range. Adequate ventilation is essential to prevent internal component failure. Keep away from areas of excessive heat or moisture.

Optional External Equipment

The Video/Audio connection between components can be made with shielded video and audio cables. For best performance, video cables should utilize 75 ohm coaxial shielded wire. Cables are available from your dealer or electronic supply store. Before you purchase any cables, be sure you know what type of output and input connectors your various components require. Also determine the length of cable you will need.

Remote Control Battery Installation

Requires two AA batteries.

1. Turn the Transmitter face down. Remove top cover by pressing down on marking and sliding cover off in the direction indicated.
2. Install the batteries as shown in the battery compartment. (Polarity + or – must match the markings in the compartment.)
3. Replace the cover and slide in reverse until the lock snaps.

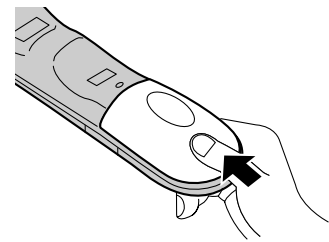
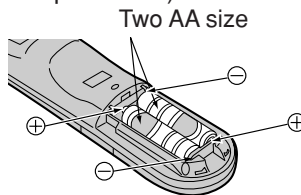
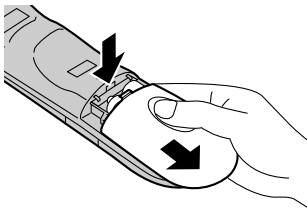

Helpful Hints:

For frequent remote control users, replace old batteries with alkaline batteries for longer life.

Helpful Hints:

Whenever you remove the batteries, **you may need to reset the remote control infrared codes.** We recommend that you record the code on page 56, prior to setting up the remote control.

⚠ Precaution on battery use

Incorrect installation can cause battery leakage and corrosion that will damage the remote control transmitter.

Observe the following precautions:

1. Batteries should always be replaced as a pair. Always use new batteries when replacing the old set.
2. Do not combine a used battery with a new one.
3. Do not mix battery types (example: "Zinc Carbon" with "Alkaline").
4. Do not attempt to charge, short-circuit, disassemble, heat or burn used batteries.
5. Battery replacement is necessary when remote control acts sporadically or stops operating the TV set.

Accessories

Accessories Supplied

Operating
Instruction book

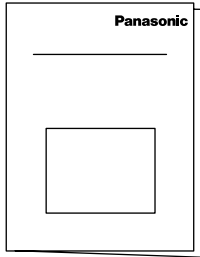

Remote Control
Transmitter
EUR7603ZC0

Batteries for the Remote
Control Transmitter
(AA Battery × 2)

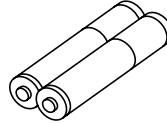

Warranty

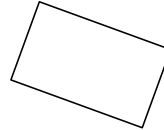

×2)

Pedestal
TY-ST42PA20

Customer Card

Service
Center List

F Type Antenna
Adapter
(for 5C-2V) (

Ferrite core (large size)
(×5)

Fixing band

AC cord

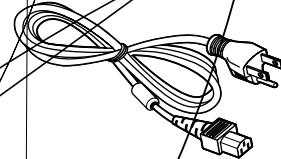

Cable Connection

Front AV terminal
(see page 12)

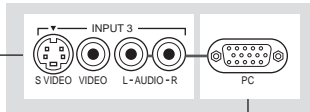

From EXTERNAL monitor terminal
on Computer (see page 17)

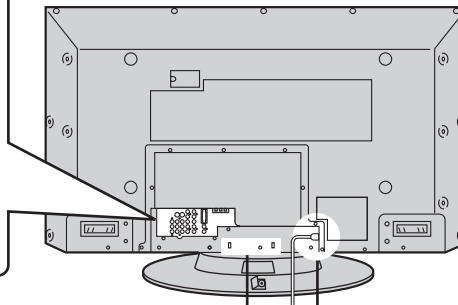
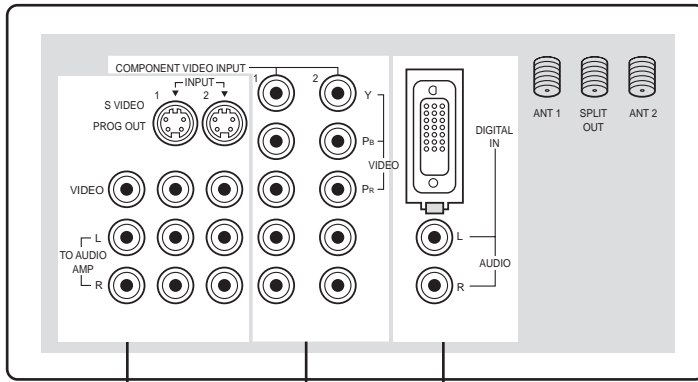

AV terminals
(see page 13,14,16)

COMPONENT
and Audio
Input terminals
(see page 15)

DIGITAL(DVI) Input terminal
(see page 16)

- AC cord fixing

1. Connect power plug to the socket of the main body.
2. Fix the left clamper.
3. Fix the right clamper.
4. Install the ferrite core.

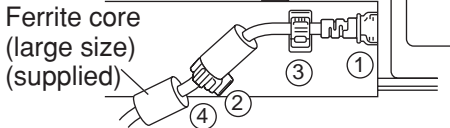

How to fix: Fix by pushing in till a clicking sound is heard.

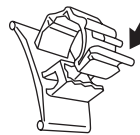

How to release: Pull up while drawing the knob.

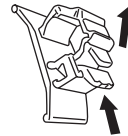

- Cable fixing bands

Secure any excess cables with bands as required.

To secure cables connected to Terminals, wrap the cable fixing band around them then pass the pointed end through the locking block, as shown in the figure.

While ensuring there is sufficient slack in cables to minimize stress (especially in the power cord), firmly bind all cables with the supplied fixing band.

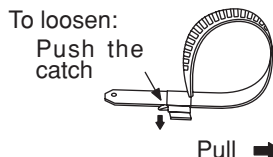
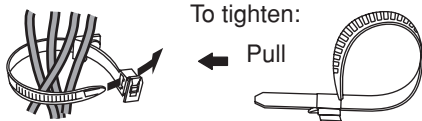

Antenna Connection

- For proper reception of VHF/UHF channels, an external antenna is required. For best reception, an outdoor antenna is recommended. Antenna Mode must be set to TV.
- Incoming Cable from Home Antenna
Connect home antenna to ANT1 connection on back of television. Select TV mode and ANT1 in the SET UP menu. (Cable Mode is preset at the factory. Antenna users must change to TV mode and select ANT1 in the Set Up Menu.)

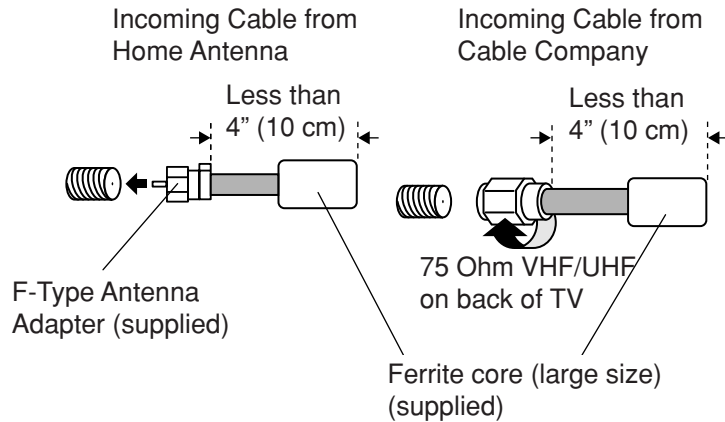
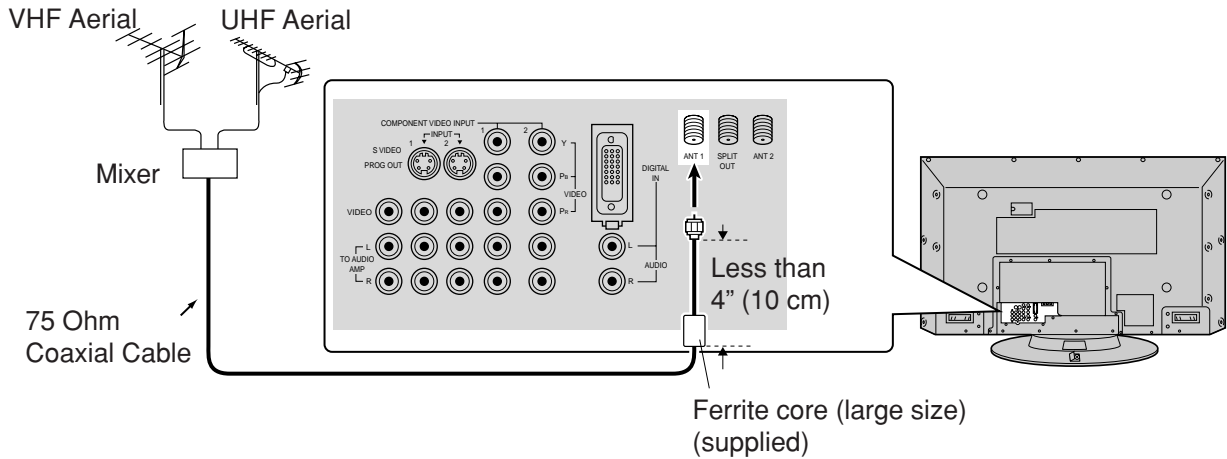

Note: Certain cable systems offset some channels to reduce interference or have Premium (scrambled) channels. A cable converter box is required for proper reception. Check with your local Cable company for its compatibility requirements.

Notes:

- (1) To obtain optimum quality picture and sound, an Aerial, the correct cable (75 Ohm coaxial) and the correct terminating plug are required.
- (2) If a communal Aerial system is used, you may require the correct connection cable and plug between the wall Aerial socket and your television receiver.
- (3) Your local Television Service Centre or Dealer may be able to assist you in obtaining the correct Aerial system for your particular area and the accessories required.
- (4) Any matters regarding Aerial installation, upgrading of existing systems or accessories required, and the costs incurred, are the responsibility of you, the Customer.

Connecting Headphones / Earphones

Connect headphones / earphones as follows.

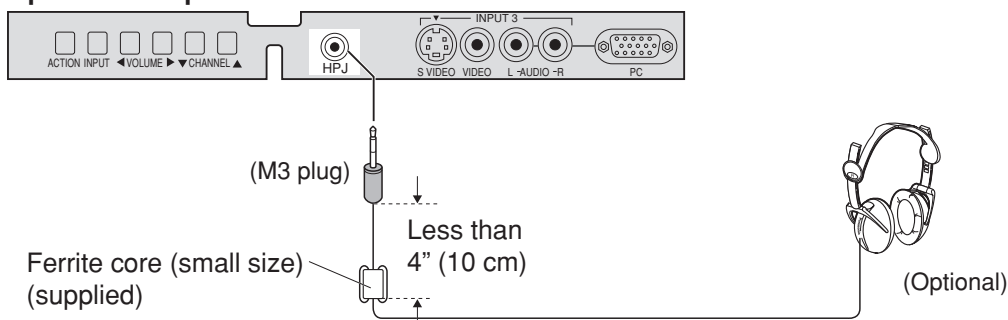



You can listen to sound from the headphone Jack.

Cable Connection

Front Control Panel

Push to open the front panel of the television to use the TV without remote control or to use the Audio/Video input jacks for optional equipment.

Press  or  to select VIDEO 3 input mode.



CAMCORDER



Note:

The front control panel can be used to access menus and switch video mode when the remote control is not available.

Ferrite core (small size)
(supplied)

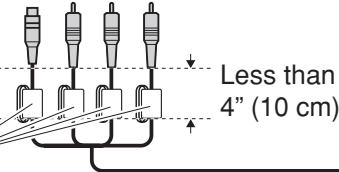

A second VCR, video disc player, video game equipment and DSS equipment can also be connected to the video inputs. See the optional equipment manual for details.

Procedure

1. Connect equipment to front Audio/Video input jacks.
2. Operate optional equipment as instructed in equipment manual.

Note:

The S-VIDEO connection provides higher quality picture. It overrides other VIDEO connections. Use INPUT 3, AUDIO L and R with S-VIDEO connection.

Optional Equipment Connections

Cable Box Connection

Follow this diagram when connecting your television to a cable box only.

CONNECTIONS ON BACK OF TV

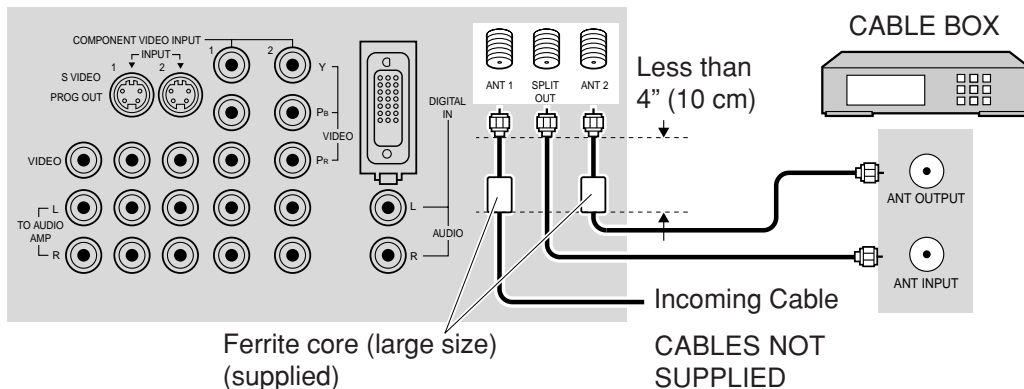

Ferrite core (large size)
(supplied)

CABLES NOT
SUPPLIED

Note: The remote control must be programmed with supplied codes to operate the cable box (see page 58).

Viewing a premium (scrambled) cable channel

Procedure

1. Select ANT2 in the SET UP menu.
2. Tune the television to Channel 3 or Channel 4.
3. Using the cable box, tune to the premium cable channel you would like to view.

Note:

To use special features such as Favorite Channels and Channel Captions, ANT1 must be selected in the SET UP menu (see page 24).

VCR Connection

Follow this diagram when connecting your television to a VCR only.

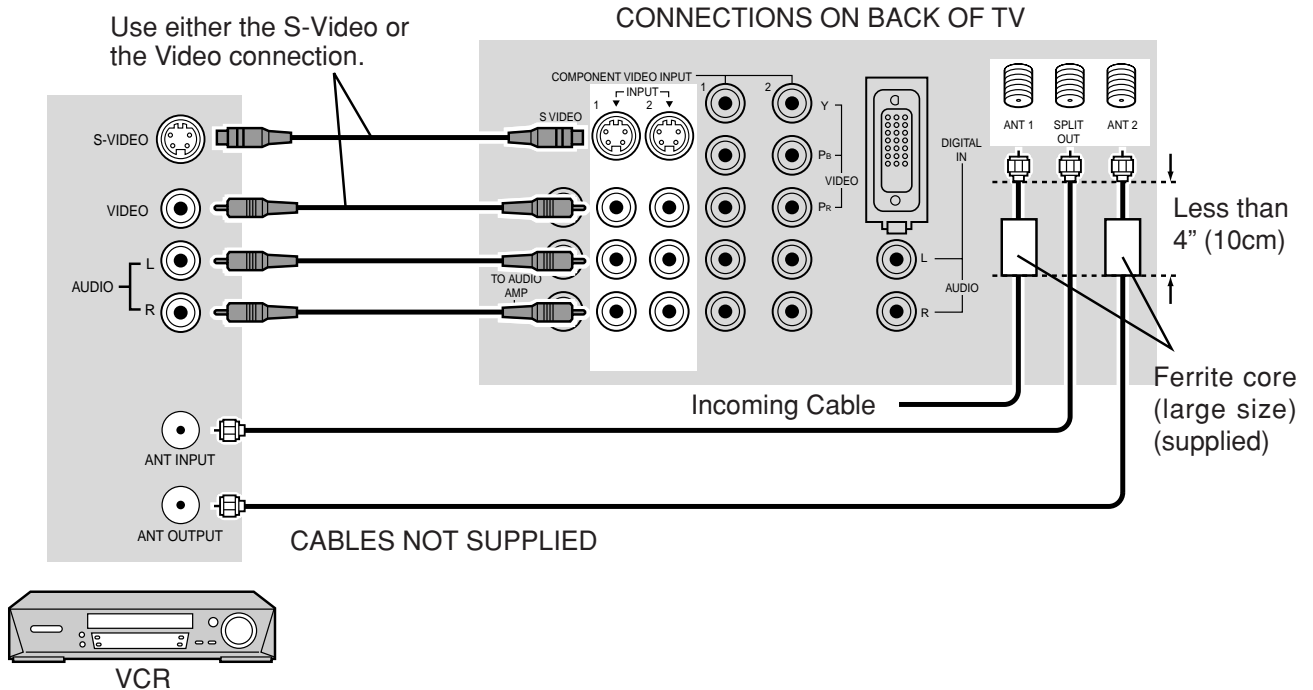

Note: The remote control must be programmed with supplied codes to operate the VCR (see page 56, 57).

Viewing a television program

Procedure

1. Select ANT1 in the SET UP menu. (See page 24)
2. Tune the television to the television program you would like to view.

Viewing a video

Procedure

- Option A
 1. Press the TV/VIDEO button on the remote control to select the video input (VIDEO 1, VIDEO 2, etc.) connected to your VCR.
 2. Begin the video.
- Option B
 1. Select ANT2 in the SET UP menu.
 2. Tune the television to Channel 3 or 4, depending on your VCR.
 3. Begin the video.

Recording a television program

Procedure

- Option A (Recording and viewing the same program)
 1. Select ANT2 in the SET UP menu.
 2. Tune the television to Channel 3 or 4, depending on your VCR.
 3. Using the VCR, tune to the television program you would like to record.
 4. Begin recording.
- Option B (Recording one program while viewing another program)
 1. Select ANT1 in the SET UP menu.
 2. Press the TV/VIDEO button on the remote control to select the video input (VIDEO 1, VIDEO 2, etc.) connected to your VCR.
 3. Using the VCR, tune to the television program you would like to record.
 4. Begin recording.
 5. Press the TV/VIDEO button on the remote control to switch back to TV mode.
 6. Tune the television to the program you would like to view.

Cable Connection

VCR and Cable Box

Less than
4" (10 cm)

vision to both a VCR and a cable box.

IS NOT SUPPLIED

Use the Video Cable Connection.

Ferrite core
(large size)
(supplied)

CABLE BOX

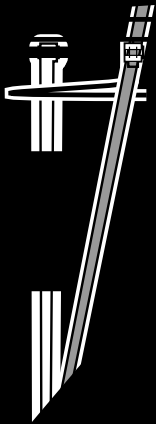

you would like to view.

Channel Captions, ANT1 must be selected in the SET UP

video input (VIDEO 1, VIDEO 2, etc.) connected

g on the back of VCR.
uld like to record.

||

leo

Digital TV - Set-Top Box (DTV-STB) or DVD Connection

This television is capable of displaying 1080i and 480p DTV signals when connected to a DTV Tuner set-top-box (STB). In order to view DTV programming, the STB must be connected to the component video inputs (Y, P_B, P_R) of the television. A DTV signal must be available in your area. Select the output of the STB to either 1080i or 480p.

This television also utilizes a progressive scan doubler, which de-interlaces the NTSC signal and progressively scans the image. This allows you to sit close to the TV and not see the thin black horizontal lines (venetian blind effect) associated with interlaced TV pictures.

Use this diagram to connect the Panasonic DTV-STB (Digital TV-Set-Top Box) or DVD Player to the back of your TV.

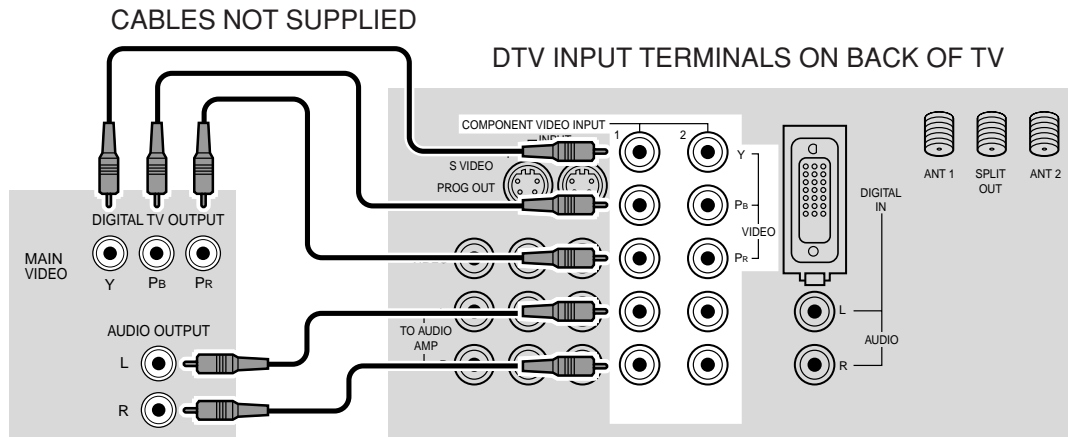

Note:

There are 2 sets of three video inputs, Y, P_B, and P_R. Separated component color inputs provide luminance and color separation. Furthermore, the L (left) and R (right) audio inputs must be used.

Amplifier Connection (TO AUDIO AMP)

To listen through a separate stereo system, connect an external audio amplifier TO AUDIO AMP outputs on back of television.

Note: TO AUDIO AMP terminals cannot be connected directly to external speakers.

Audio Adjustments

Procedure

1. Select SPEAKERS ON located in the onscreen AUDIO menu.
2. Set amplifier volume to minimum.
3. Adjust television volume to desired level.
4. Adjust amplifier volume to match the television.
5. Select SPEAKERS OFF & VARIABLE AUDIO OUT from AUDIO menu.
6. Volume, mute, bass, treble and balance are now controlled through the television.

Select SPEAKERS OFF & FIXED AUDIO OUT to control audio functions through the external amplifier.

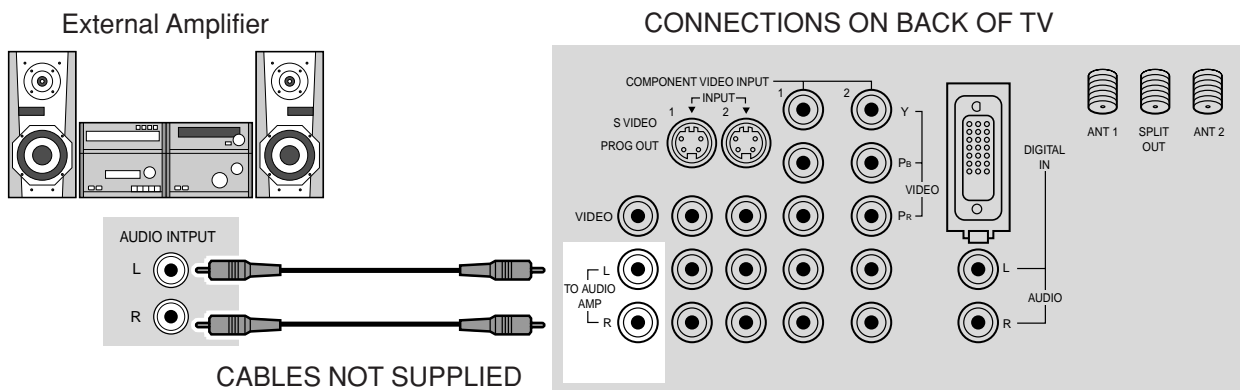

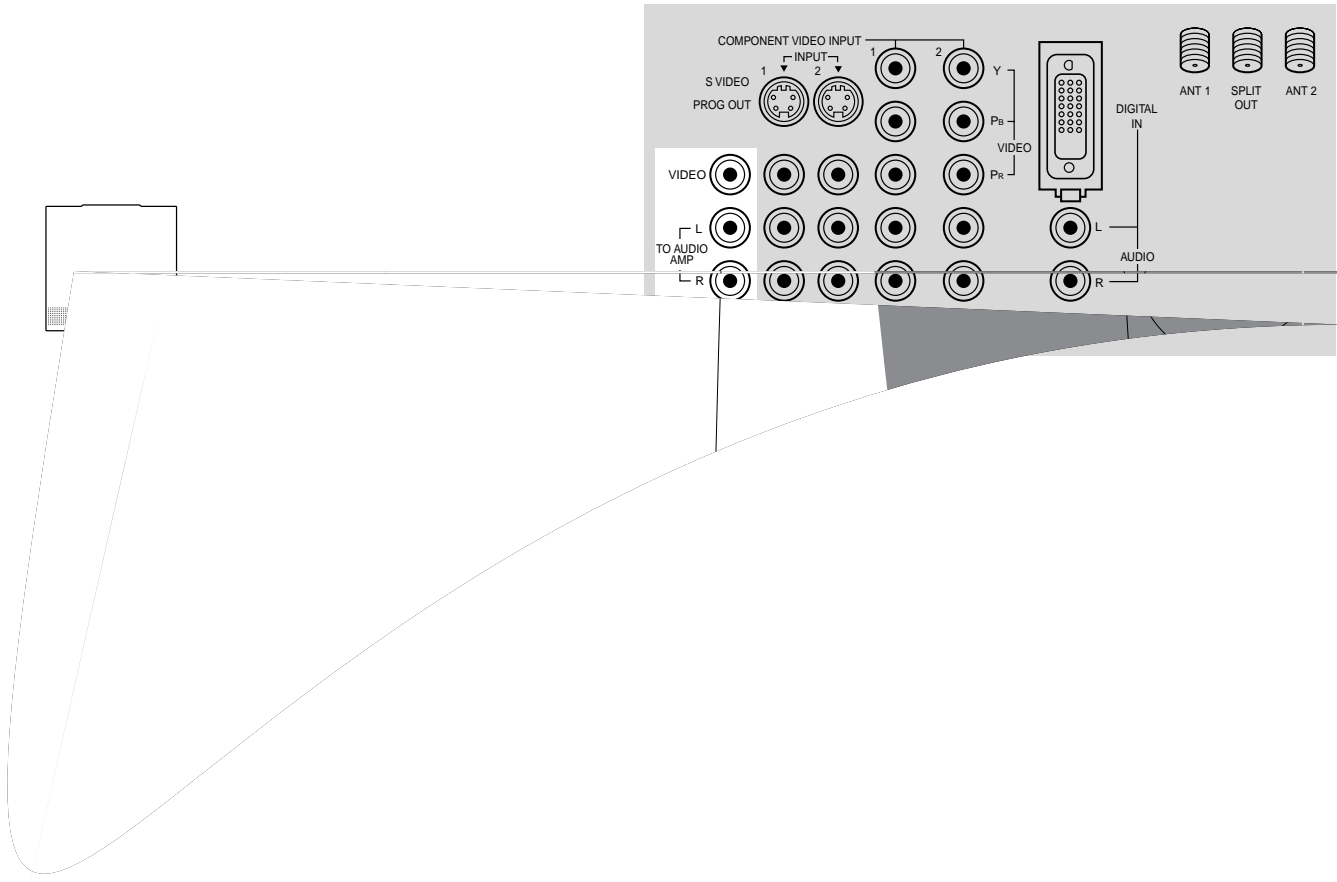

PC Input Terminals connection

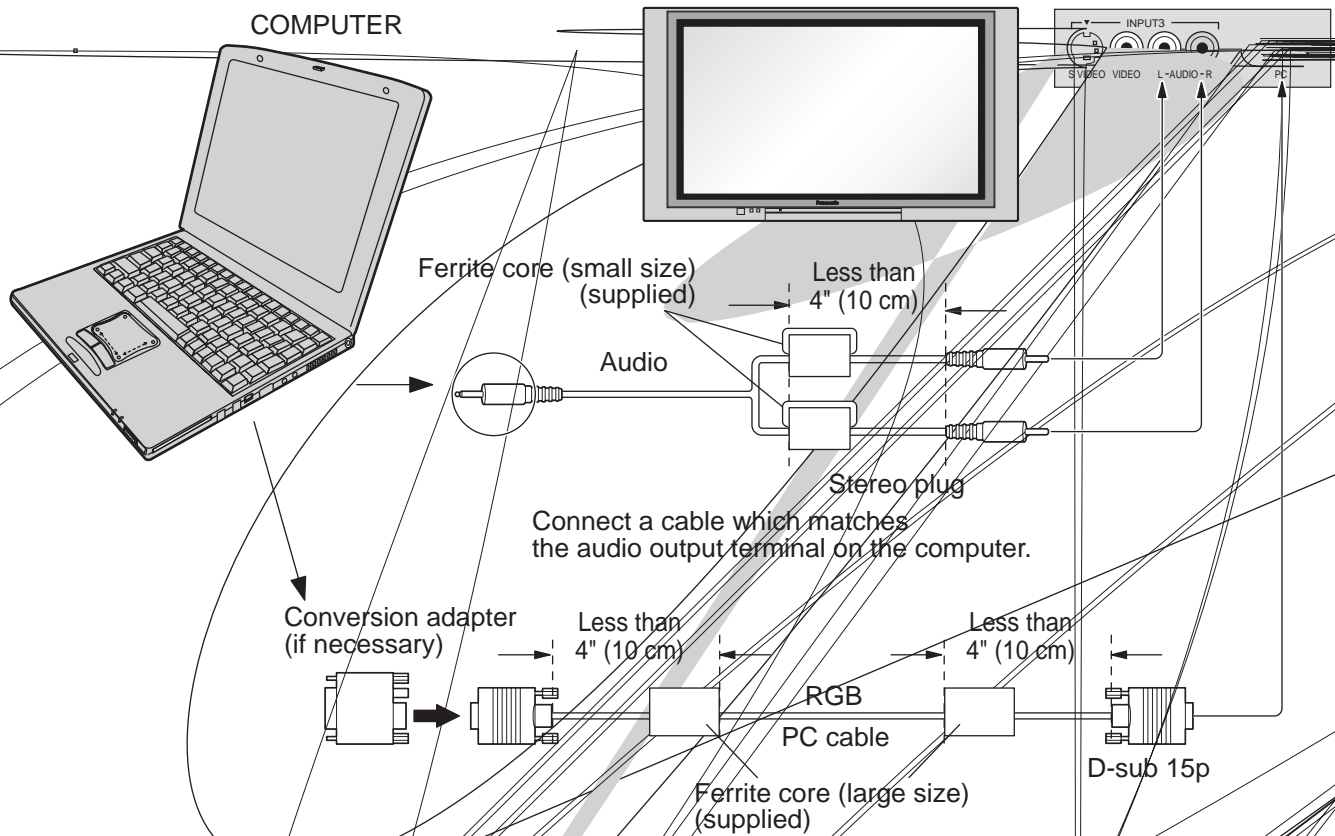

Notes:

- (1) Computer signals which can be input are those with a horizontal scanning frequency of 15 to 110 kHz and vertical scanning frequency of 48 to 120 Hz. (However, the image will not be displayed properly if the signals exceed 1,200 lines.)
- (2) The display resolution is a maximum of 640 × 480 dots when the aspect mode is set to "4:3", and 852 × 480 dots when the aspect mode is set to "16:9". If the display resolution exceeds these maximums, it may not be possible to show fine detail with sufficient clarity.
- (3) Some PC models cannot be connected to the set.
- (4) There is no need to use an adapter for computers with DOS/V compatible D-sub 15P terminal.
- (5) The computer shown in the illustration is for example purposes only.
- (6) Additional equipment and cables shown are not supplied with this set.
- (7) Do not set the horizontal and vertical scanning frequencies for PC signals which are above or below the specified frequency range.

Signal Names for D-sub 15P Connector

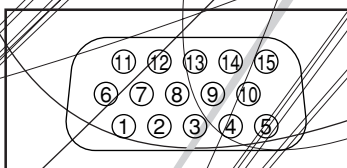

Pin Layout for PC Input Terminal

Pin No.	Signal Name	Pin No.	Signal Name	Pin No.	Signal Name
①	R	⑥	GND (Ground)	⑪	NC (not connected)
②	G	⑦	GND (Ground)	⑫	NC
③	B	⑧	GND (Ground)	⑬	HD/SYNC
④	NC (not connected)	⑨	NC (not connected)	⑭	VD
⑤	GND (Ground)	⑩	GND (Ground)	⑮	NC

Power ON / OFF

AC cord connection

Connecting the AC cord plug to the Plasma TV.

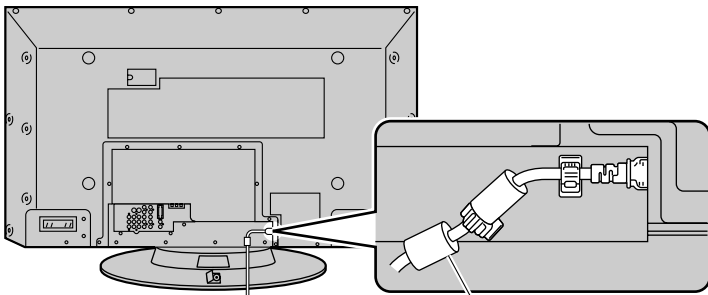

Fix the AC cord plug securely to the Plasma TV with the clamer.

Ferrite core (large size) (supplied)

How to Turn the Power On

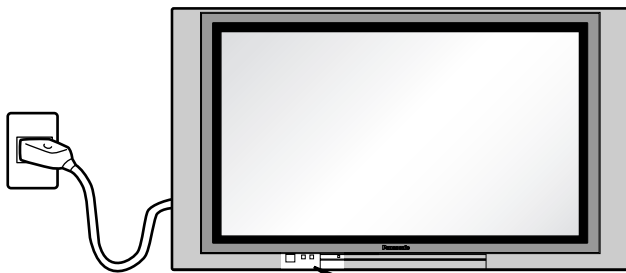

Connecting the Plug to the Wall Outlet

Note:

The TV's power cord must first be plugged into the wall outlet and then turned on at the POWER switch (standby mode).

Press the POWER switch on the TV to turn the set on.
POWER-ON: Red

When the set is on press the POWER switch on the TV to turn the set off.

STANDBY: No light

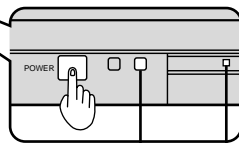

Remote Control sensor

Power indicator

Example: The screen below is displayed for a while after the TV is turned on. (setting condition is an example.)

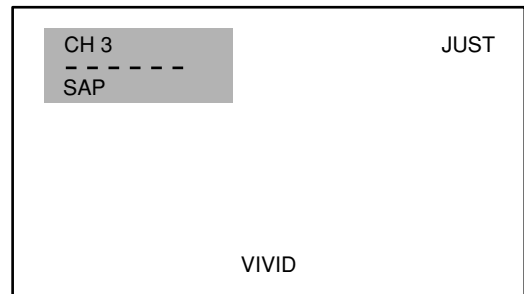
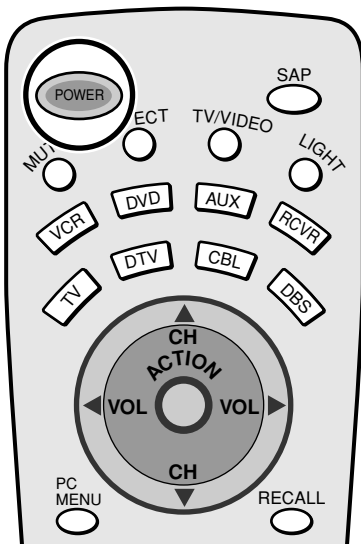

Press the POWER button on the remote control to turn the TV on: Red

Press the POWER button on the remote control to turn the TV off: No light (standby)

Note:

The TV will still consume some power as long as the power cord is still inserted into the wall outlet.

Menu Language Selection

In SET UP Menu, Select IDIOMA/LANGUE to change menu language to ENGLISH, ESPAÑOL (Spanish) or FRANÇAIS (French). (refer to page 24)

Cable TV / VHF, UHF and CATV

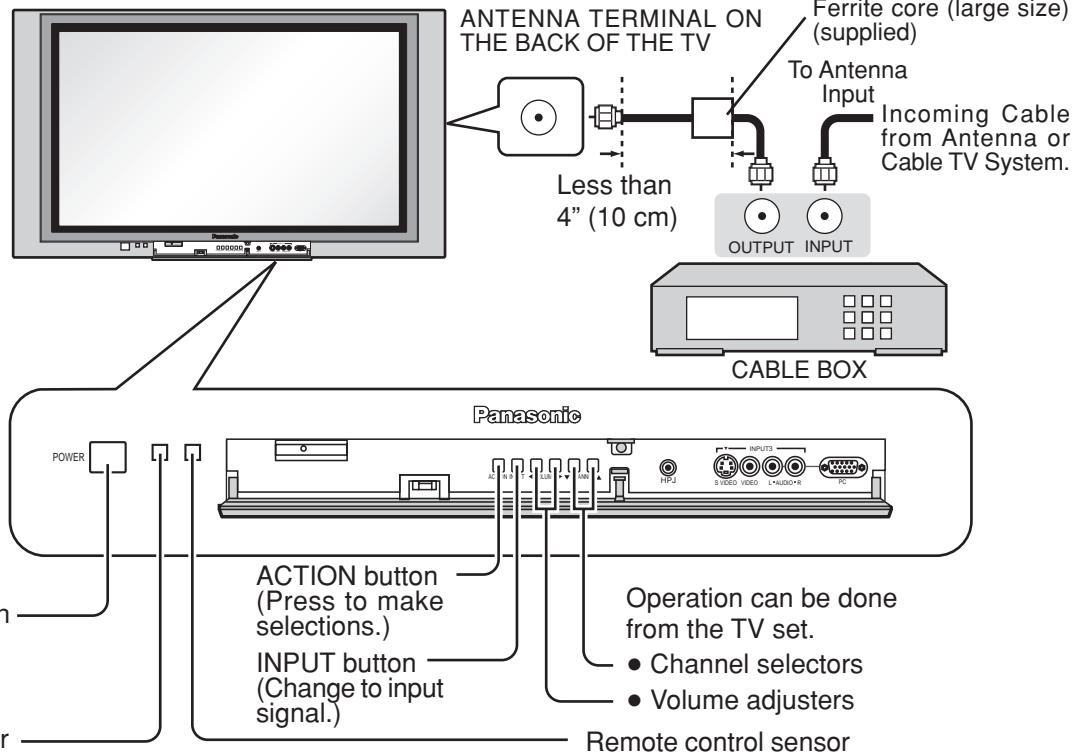
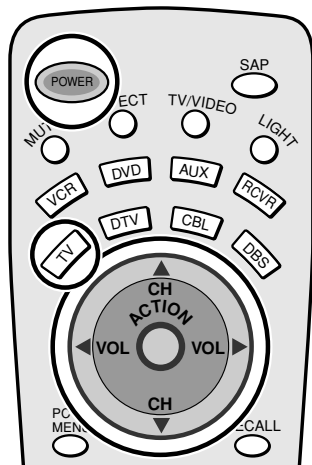

Plasma C.A.T.S (Contrast Automatic Tracking System)
 Plasma C.A.T.S automatically senses the ambient light conditions and adjusts the brightness and gradation accordingly, to optimise contrast.
 (Effective when Picture mode is set to Auto.)

Cable TV

When the antenna cable is connected to the TV antenna terminal via a cable box or VCR, set the TV channel to CH3 or CH4.

This does not apply when signal is input from VIDEO INPUT.

Confirming

Confirm that registration with cable TV provider and connection of equipment are completed. Turn the CABLE BOX on and select the desired volume level.

- 1 Press to confirm.
- 2 Press while pointing the remote control towards the CABLE BOX.

Note:
 The remote control code number is set for Panasonic products.
 When peripheral equipment does not operate, reset code (See page 54 - 55).

- 3 Operate the CABLE BOX and select the desired volume level.

VHF, UHF and CATV

- 1 Press to operate the TV set with the remote control.

- 2 Press to turn the TV on (See page 18).

- 3 Press to select the desired channel.

- 4 Select the desired volume level.

Notes:
 (1) The channel number and volume level remain the same even after the TV is turned off.
 (2) Power consumption and howling sound can be reduced if the volume level is lowered.

Location of Controls

Illuminated Remote Control

Power button

Press to turn the TV ON or OFF (See page 18).

Note: The TV's power cord must first be plugged into the wall outlet and then turned on at the POWER switch (standby mode).

ASPECT button

Change of screen size (See page 50).

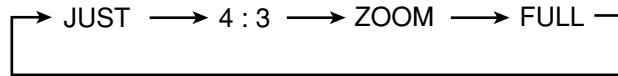

MUTE button

Press this button to mute the sound, press again to cancel the mute.

Mode Selection buttons

Selects the operation mode for the remote control. (See page 55)

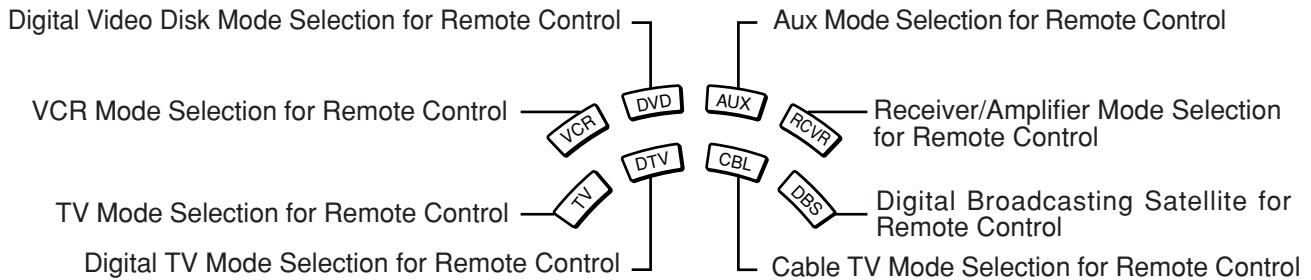

R-TUNE R-TUNE button



Switches to previously viewed channel or video mode.

Operation of other Device

Buttons Device	PIP MIN REW / PIP MAX FF	PLAY	PAUSE	STOP
TV	PIP Minimize/Maximize	—	—	—
VCR	VCR REW/FF	PLAY	Pause	STOP
CABLE/DBS	—	—	—	—
DVD/LD/CD	Skip Search REW/FF	PLAY	Pause	STOP
RCVR	Surround —/+	—	—	—

Buttons Device	REC	FREEZE TV/VCR	PIP CH VCR CH	SEARCH OPEN/CLOSE
TV	—	PIP or SPLIT FREEZE	PIP or SPLIT CH up/down	PIP Search
VCR	VCR RECORD	TV/VCR Switch	VCR CH up/down	—
CABLE/DBS	DBS RECORD	TV/DBS Switch	TV/DBS CH up/down	—
DVD/LD/CD	—	—	—	OPEN/CLOSE
RCVR	—	—	—	—

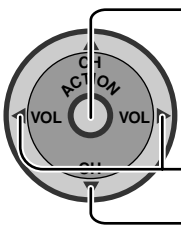

Basic Menu Operations

- 1
- 
- Press to display the menu screen.
 - Press to select desired menu icon.
 - Press to enter submenu field.

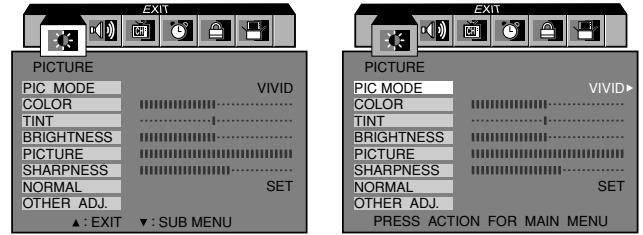

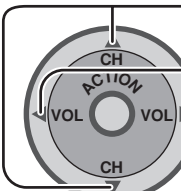
- 2
- 
- Press to select desired submenu feature.
 - Press to select or adjust.

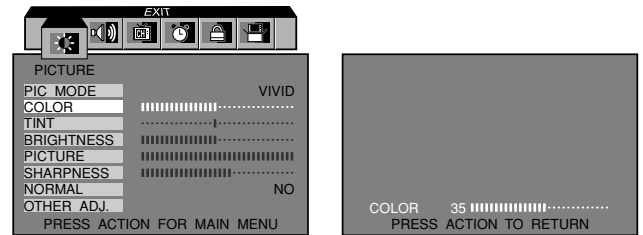

[for OTHER ADJ.]

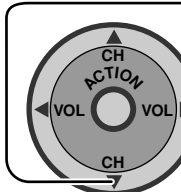
- 
- Press to select OTHER ADJ.
 - Press to enter option menu field.
- ↓
- Proceed to selection and adjustment of the option menu.

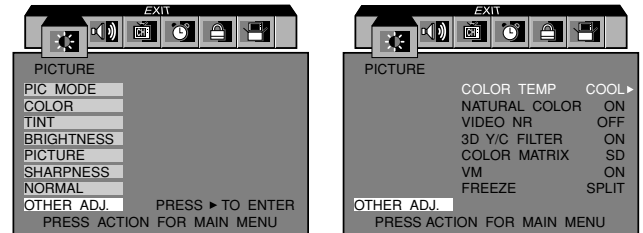

To return to MAIN MENU: To return to previous screen:

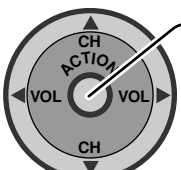
- 
- Press to return.

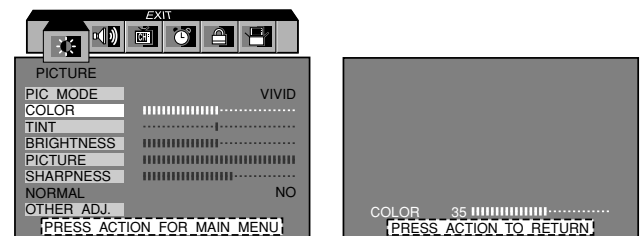



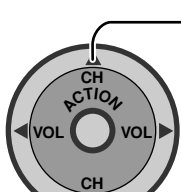

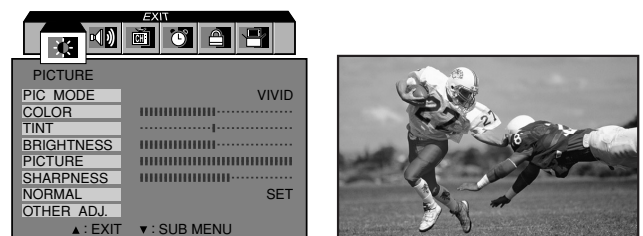

To end adjustments:

- 
- Press to exit from the MENU screen. This returns the set to the normal viewing condition.



NORMAL PICTURE

Basic Menu Operations

 <p>PICTURE</p>	<p>PICTURE</p> <p>PIC MODE <input type="text"/> VIVID</p> <p>COLOR <input type="text"/></p> <p>TINT <input type="text"/></p> <p>BRIGHTNESS <input type="text"/></p> <p>PICTURE <input type="text"/></p> <p>SHARPNESS <input type="text"/></p> <p>NORMAL <input type="text"/> SET</p> <p>OTHER ADJ. <input type="text"/></p> <p>▲ : EXIT ▼ : SUB MENU</p>	<p>PICTURE</p> <p>PIC MODE <input type="text"/></p> <p>COLOR <input type="text"/></p> <p>TINT <input type="text"/></p> <p>BRIGHTNESS <input type="text"/></p> <p>PICTURE <input type="text"/></p> <p>SHARPNESS <input type="text"/></p> <p>NORMAL <input type="text"/></p> <p>OTHER ADJ. <input type="text"/> PRESS ► TO ENTER</p> <p>PRESS ACTION FOR MAIN MENU</p>	<p>PICTURE</p> <p>COLOR TEMP NORMAL ►</p> <p>NATURAL COLOR ON</p> <p>VIDEO NR OFF</p> <p>3D Y/C FILTER ON</p> <p>COLOR MATRIX SD</p> <p>FREEZE SPLIT</p> <p>OTHER ADJ. <input type="text"/></p> <p>PRESS ACTION FOR MAIN MENU</p>																																
 <p>AUDIO</p>	<p>AUDIO</p> <p>MODE <input type="text"/> STEREO SAP MONO</p> <p>BASS <input type="text"/></p> <p>TREBLE <input type="text"/></p> <p>BALANCE <input type="text"/></p> <p>NORMAL <input type="text"/> SET</p> <p>OTHER ADJ. <input type="text"/></p> <p>PRESS ACTION FOR MAIN MENU</p>	<p>AUDIO</p> <p>MODE <input type="text"/></p> <p>BASS <input type="text"/></p> <p>TREBLE <input type="text"/></p> <p>BALANCE <input type="text"/></p> <p>NORMAL <input type="text"/></p> <p>OTHER ADJ. <input type="text"/> PRESS ► TO ENTER</p> <p>PRESS ACTION FOR MAIN MENU</p>	<p>AUDIO</p> <p>AI SOUND ON</p> <p>BBE VIVA 3D ON ►</p> <p>BBE ON</p> <p>SURROUND 3D</p> <p>SPEAKERS ON</p> <p>OTHER ADJ. <input type="text"/></p> <p>PRESS ACTION TO RETURN</p>																																
 <p>CHANNELS</p>	<p>CHANNELS</p> <p>CH. SCAN <input type="text"/> ALL ►</p> <p>FAVORITES <input type="text"/> ENTER CHANNEL 3</p> <p>FAVORITE CHANNELS</p> <p>2 5 8 10</p> <p>18 25</p> <p>► : ADD</p> <p>◄ : DELETE</p> <p>OTHER ADJ. <input type="text"/></p> <p>PRESS ACTION FOR MAIN MENU</p>	<p>CHANNELS</p> <p>CH. SCAN <input type="text"/></p> <p>FAVORITES <input type="text"/></p> <p>OTHER ADJ. <input type="text"/> PRESS ► TO ENTER</p> <p>PRESS ACTION FOR MAIN MENU</p>	<p>CHANNELS</p> <p>PRESET CAPTION ►</p> <p>MANUAL CAPTION ►</p> <p>INPUT LABEL ►</p> <p>OTHER ADJ. <input type="text"/></p> <p>PRESS ACTION TO RETURN</p>																																
	<p>CHANNELS</p> <p>PRESET CAPTION</p> <table border="0"> <tr><td>ABC</td><td><input type="text"/></td><td>A&E</td><td>----</td></tr> <tr><td>CBS</td><td><input type="text"/></td><td>AMC</td><td>----</td></tr> <tr><td>FOX</td><td><input type="text"/></td><td>BET</td><td>----</td></tr> <tr><td>NBC</td><td><input type="text"/></td><td>BRAVO</td><td>----</td></tr> <tr><td>PBS</td><td><input type="text"/></td><td>CNBC</td><td>----</td></tr> <tr><td>CNN</td><td><input type="text"/></td><td>CNN/SI</td><td>----</td></tr> <tr><td>ESPN</td><td><input type="text"/></td><td>COMEDY</td><td>----</td></tr> <tr><td>HBO</td><td><input type="text"/></td><td>COURT</td><td>----</td></tr> </table> <p>PRESS ▼ FOR MORE CHANNELS</p> <p>PRESS ACTION TO RETURN</p>	ABC	<input type="text"/>	A&E	----	CBS	<input type="text"/>	AMC	----	FOX	<input type="text"/>	BET	----	NBC	<input type="text"/>	BRAVO	----	PBS	<input type="text"/>	CNBC	----	CNN	<input type="text"/>	CNN/SI	----	ESPN	<input type="text"/>	COMEDY	----	HBO	<input type="text"/>	COURT	----	<p>CHANNELS</p> <p>MANUAL CAPTION</p> <p>ENTER CHANNEL <input type="text"/> 10</p> <p>ENTER CAPTION <input type="text"/> ----</p> <p>▲ TO MOVE CURSOR ▼</p> <p>◄ TO SELECT CHANNEL ►</p> <p>PRESS ACTION TO RETURN</p>	<p>CHANNELS</p> <p>INPUT LABEL</p> <p>COMPONENT1 <input type="text"/></p> <p>COMPONENT2 <input type="text"/></p> <p>DIGITAL-IN <input type="text"/></p> <p>VIDEO1 <input type="text"/></p> <p>VIDEO2 <input type="text"/></p> <p>VIDEO3 <input type="text"/></p> <p>▲ TO MOVE CURSOR ▼</p> <p>◄ TO SELECT LEVEL ►</p> <p>PRESS ACTION TO RETURN</p>
ABC	<input type="text"/>	A&E	----																																
CBS	<input type="text"/>	AMC	----																																
FOX	<input type="text"/>	BET	----																																
NBC	<input type="text"/>	BRAVO	----																																
PBS	<input type="text"/>	CNBC	----																																
CNN	<input type="text"/>	CNN/SI	----																																
ESPN	<input type="text"/>	COMEDY	----																																
HBO	<input type="text"/>	COURT	----																																
 <p>TIMER</p>	<p>TIMER</p> <p>SLEEP <input type="text"/> NO ►</p> <p>TIMER1 <input type="text"/></p> <p>TIMER2 <input type="text"/></p> <p>CLOCK SET <input type="text"/></p> <p>PRESS ACTION FOR MAIN MENU</p>	<p>TIMER</p> <p>DAY <input type="text"/> MON-FRI ►</p> <p>TIMER1 <input type="text"/> ON TIME --:--</p> <p>OFF TIME --:--</p> <p>ENTER CHANNEL ---</p> <p>SET NO</p> <p>PRESS ACTION TO RETURN</p>	<p>TIMER</p> <p>CLOCK SET <input type="text"/> --:-- --</p> <p>PRESS ACTION TO RETURN</p>																																
 <p>LOCK</p>	<p>LOCK</p> <p>CREATE <input type="text"/> <input type="text"/> ----</p> <p>CODE FIRST <input type="text"/></p> <p>PRESS ACTION FOR MAIN MENU</p>	<p>LOCK</p> <p>ENTER CODE <input type="text"/> <input type="text"/> ----</p> <p>PRESS ACTION FOR MAIN MENU</p>	<p>LOCK</p> <p>LOCK SET <input type="text"/> OFF ►</p> <p>V-CHIP SET BLOCK PROGRAMS :</p> <p>U.S. MOVIES ►</p> <p>SESTTING:</p> <p>HOW LONG? <input type="text"/> 12HOURS ►</p> <p>CODE <input type="text"/> CHANG CODE ----</p> <p>PRESS ACTION FOR MAIN MENU</p>																																
 <p>SET UP</p>	<p>SET UP</p> <p>IDIOMA/ LANGUE <input type="text"/> ENGLISH ►</p> <p>ANTENNA ANT1</p> <p>ON MUTE NO</p> <p>MODE OFF</p> <p>OTHER ADJ. <input type="text"/> PRESS ► TO ENTER</p> <p>PRESS ACTION FOR MAIN MENU</p>	<p>SET UP</p> <p>MODE CABLE ►</p> <p>AUTO PROGRAM ►</p> <p>MANUAL PROGRAM ►</p> <p>AUTO POWER ON OFF</p> <p>OTHER ADJ. <input type="text"/> CHAN BANNER ON</p> <p>SIDE BAR BRIGHT ►</p> <p>POWER SAVE OFF ►</p> <p>PRESS ACTION TO RETURN</p>	<p>MANUAL PROGRAM</p> <p>ENTER CHANNEL 3</p> <p>► TO ADD</p> <p>◄ TO DELETE</p> <p>PRESS ACTION TO RETURN</p>																																

SET UP Operation

MENU Languages

In SET UP Menu, select IDIOMA / LANGUE to change menu language to ENGLISH, ESPAÑOL (Spanish) or FRANÇAIS (French).

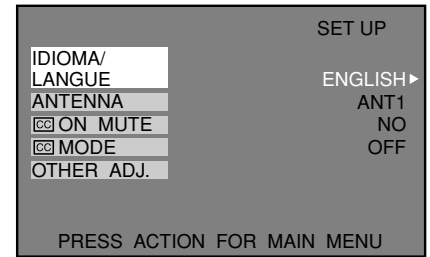
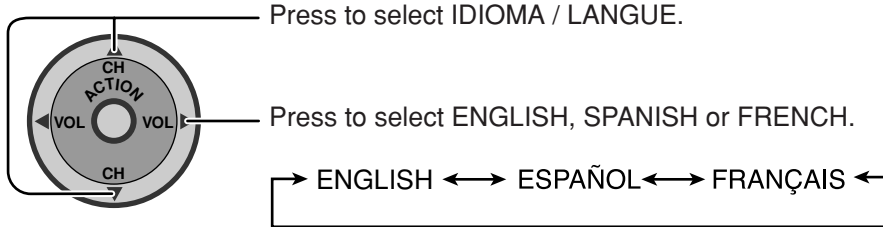

ANTENNA Selection

To select either ANT1 or ANT2.

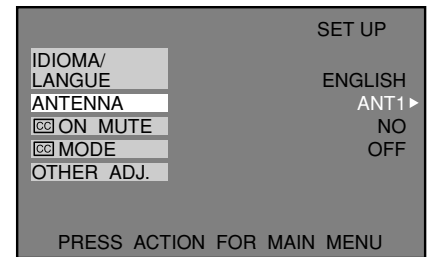

ON MUTE MODE (Closed Captions)

This receiver has a built in decoder that provides a visual depiction of the audio portion of a television program in the form of written words across the screen (white or colored letters on a black background). It allows the viewer to read the dialogue of a television program or other information.

ON MUTE

Activates the On-Screen Closed Caption feature, when the MUTE button on the Remote Control is pressed. To deactivate, press the MUTE button again.

Note:

This feature functions when the Closed Caption Mode is in the "OFF" position. The program being viewed must be broadcast with Closed Caption.

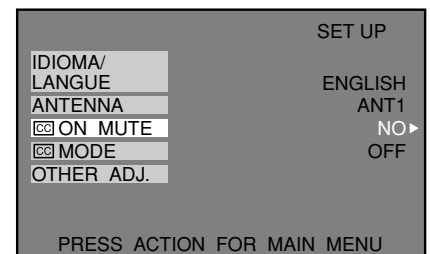
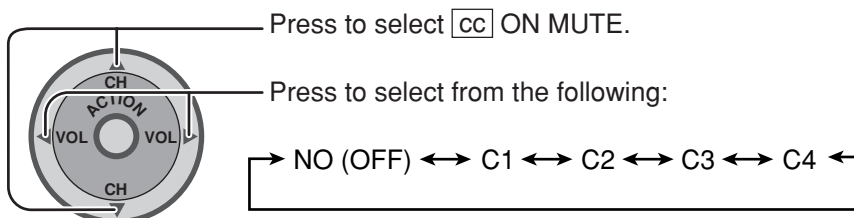

CC MODE

Activates the On-Screen Closed Caption feature. When activated this feature will remain on until OFF is selected in this menu.

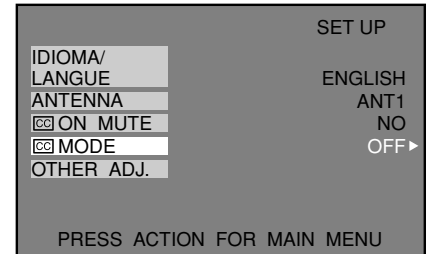
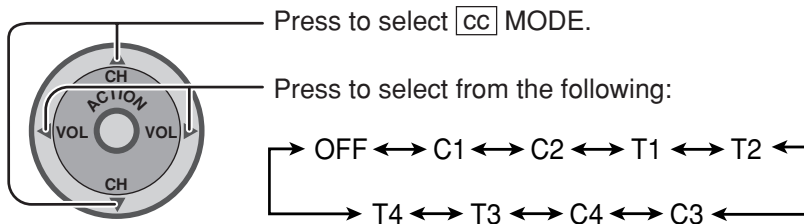

- **CAPTION OFF** - Recommended mode when Closed Caption is not being used.
- **CAPTION C1** - For video related information that can be displayed (up to 4 lines of script strategically placed on the television screen so that it does not obstruct relevant parts of the picture).
- **CAPTION C2** - Another mode used for video related information.
- **TEXT T1** - Blanks out a large portion of the picture on the television screen, and displays program guide or any other information currently being transmitted.
- **TEXT T2** - Another mode which displays information and blanks out a large portion of the picture on the television screen.
- **CAPTION C3** - Another mode used for video related information.
- **CAPTION C4** - Another mode used for video related information.
- **TEXT T3** - Another mode which displays information and blanks out a large portion of the picture on the television screen.
- **TEXT T4** - Another mode which displays information and blanks out a large portion of the picture on the television screen.

Notes:

(1) Recommended menu Set Up for Closed Caption when using Mute Button.

CC ON MUTE: C1

CC MODE: OFF

(2) The setting for CC ON MUTE is valid only when the CC MODE is OFF. CC MODE set to ON will override CC ON MUTE. This menu cannot be selected when the MAIN picture is displaying a COMPONENT VIDEO INPUT of 480i or more.

(3) When aspect is ZOOM, Closed Caption cannot be used.

Selecting option menus in OTHER ADJ.

To select option menus in OTHER ADJ.

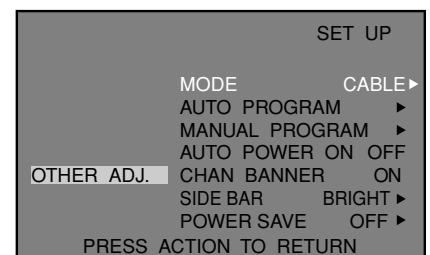
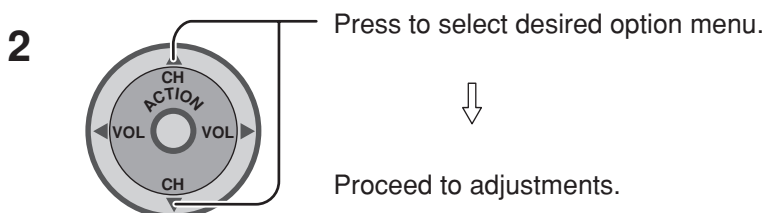
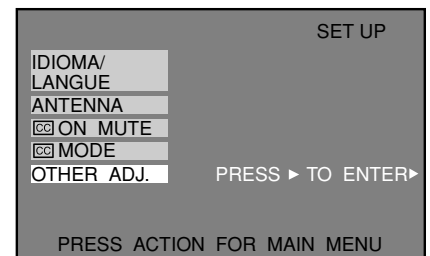
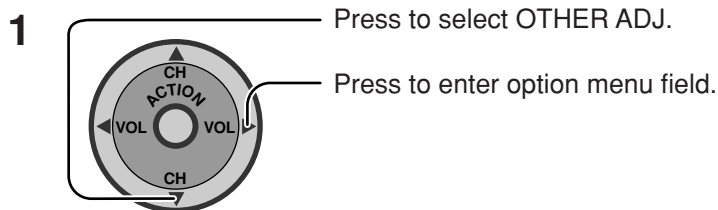

SET UP Operation

MODE Selection

To select either CABLE or TV.

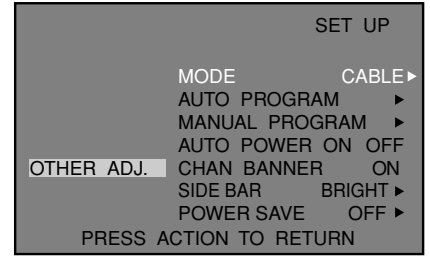
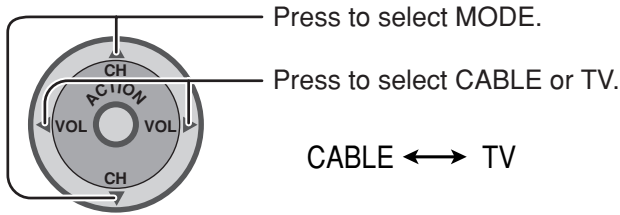

AUTO PROGRAM

To automatically program all channels with signal.

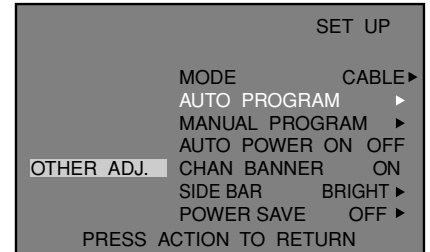
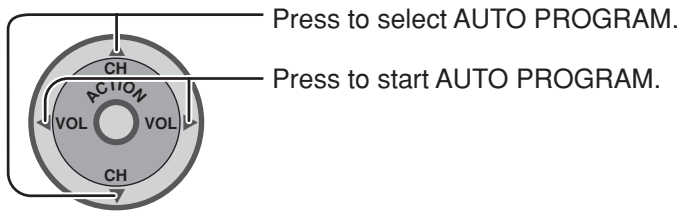

MANUAL PROGRAM

To manually add or delete channels.

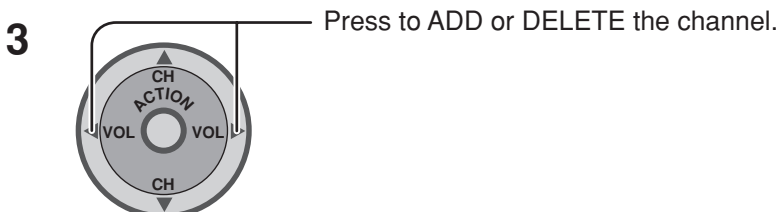
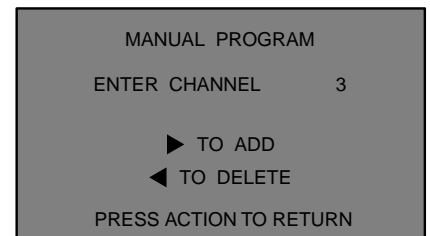
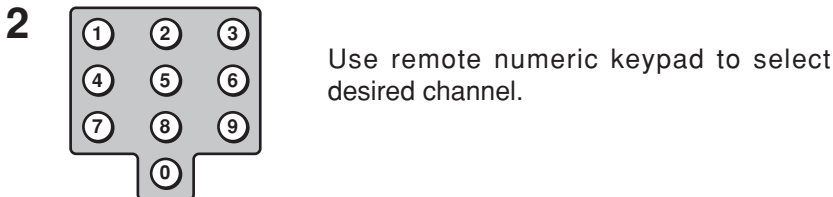
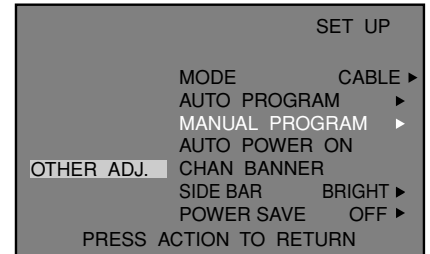
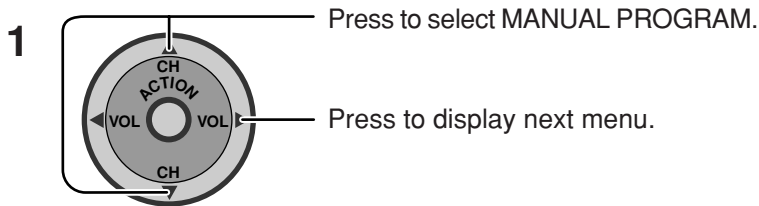

AUTO POWER ON

Select SET to power up the TV at the same time as the cable box or other components or select OFF.

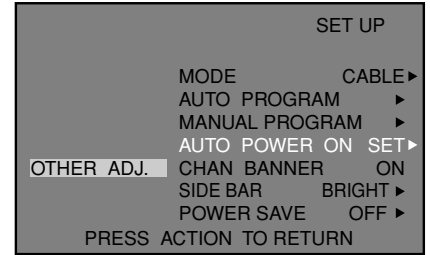
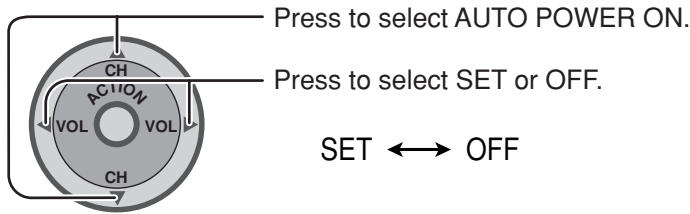

CHAN BANNER

Select ON to display the CHANNEL BANNER on the screen or select OFF.

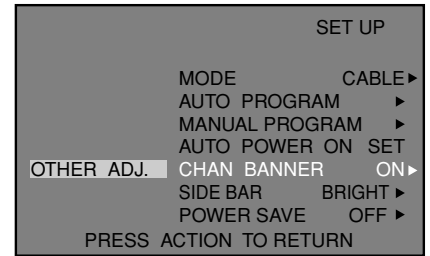
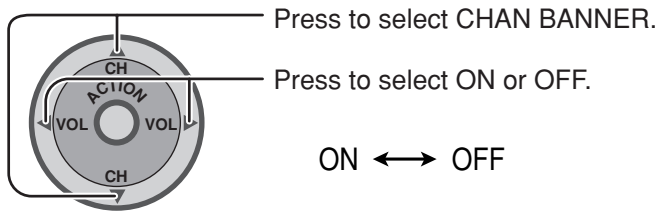

SIDE BAR

Do not display a picture in 4:3 mode for an extended period, as this can cause an after-image to remain on the side bars on either side of the display field.

To prevent the appearance of such an after-image, change the brightness of the side bars.

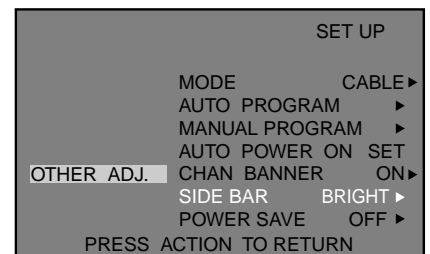
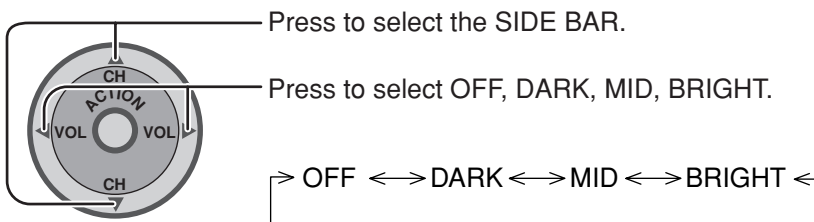
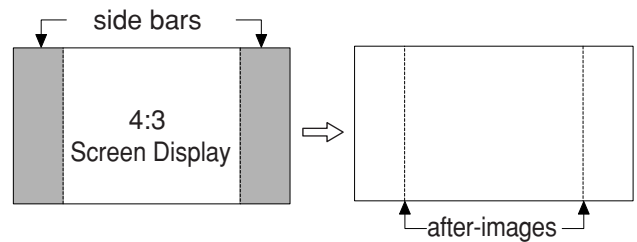

Notes:

- Setting the side bar to bright mode for an extended period may result in occurrence of after-images.
- The side bar may flash (alternate black/white) depending on the picture being shown on the screen. In such an occurrence, use the Cinema mode.

SET UP Operation

POWER SAVE

When this function is turned ON, luminous level of plasma TV is suppressed, so power consumption is reduced.

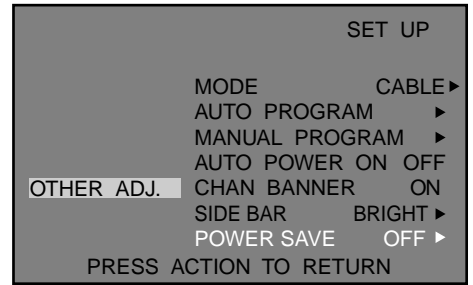
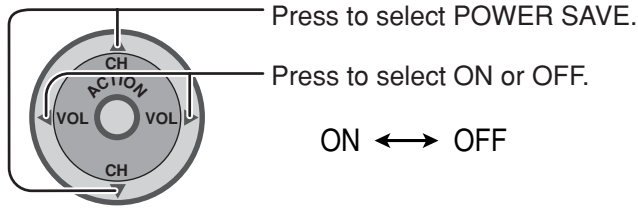

PICTURE Adjustment

PICTURE MODE

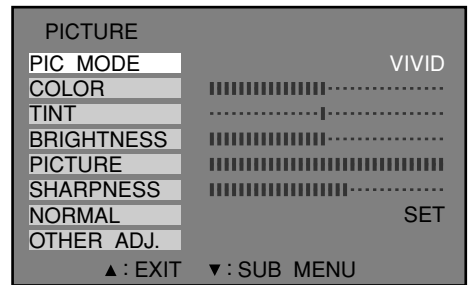
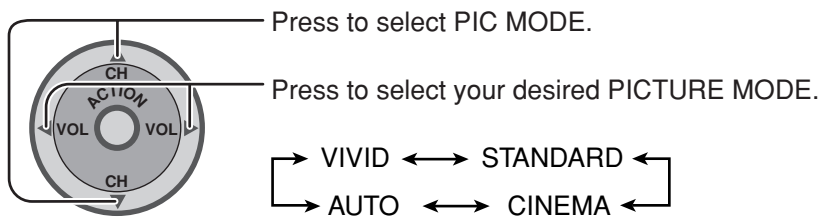

COLOR / TINT / BRIGHTNESS / PICTURE / SHARPNESS / NORMAL

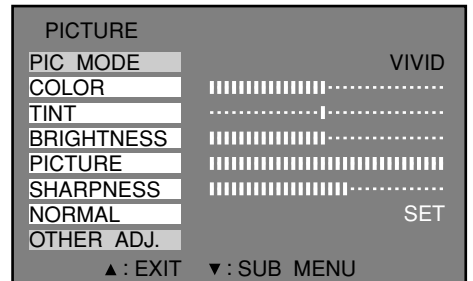
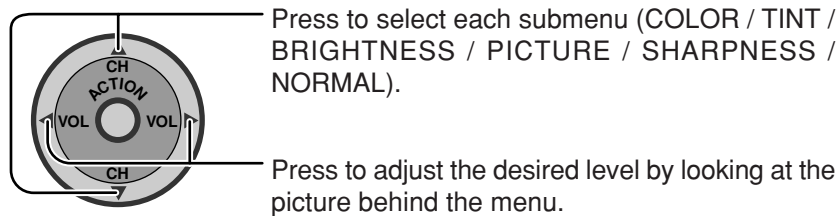

Item	Function
COLOR	Adjusts desired color intensity.
TINT	Adjusts natural flesh tones.
BRIGHTNESS	Adjusts dark areas of picture.
PICTURE	Adjusts white areas of picture.
SHARPNESS	Adjusts clarity of outline detail.
NORMAL	Resets all picture adjustments to factory default settings.

Selecting option menus in OTHER ADJ.

To select option menus in OTHER ADJ.

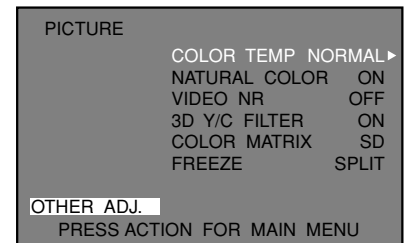
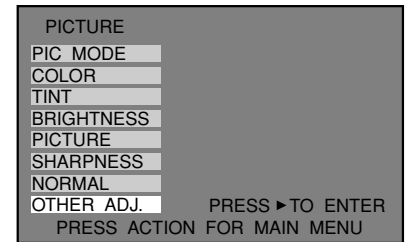
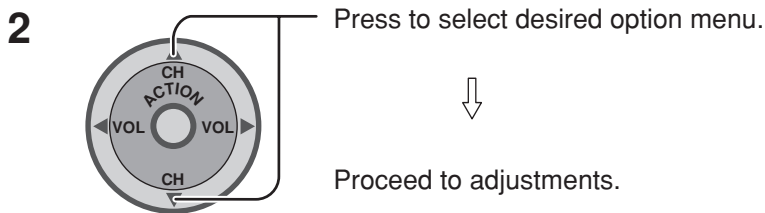
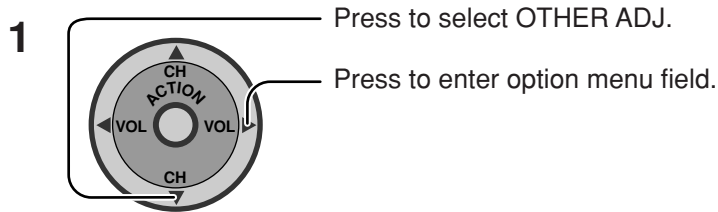

COLOR TEMP (Temperature) / NATURAL COLOR / VIDEO NR / 3D Y/C FILTER

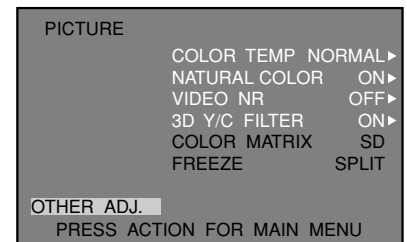
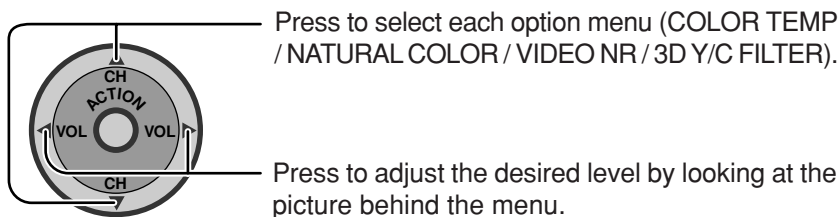

Item	Mode	Explanations
COLOR TEMP (temperature)		To increase or decrease WARM (red) and COOL (blue) colors to suit personal preferences.
NATURAL COLOR	ON ↔ OFF	To increase the color reproduction range with natural color gradation and highly delicate hues.
VIDEO NR	ON ↔ OFF	Reduces noise in the channel, commonly called snow. Remains off when receiving a strong signal.
3D Y/C FILTER	ON ↔ OFF	Minimizes noise and cross color in the picture.

COLOR MATRIX

Displays input signals (480p signals) in a natural color from digital equipment adaptors connected to COMPONENT VIDEO INPUT (Y, Pb/Cb, Pr/Cr input terminals).

Select HD or SD to automatically adjust color parameters for HD (high definition) and SD (standard definition).

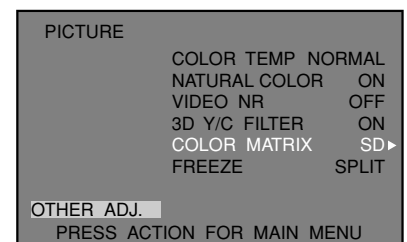
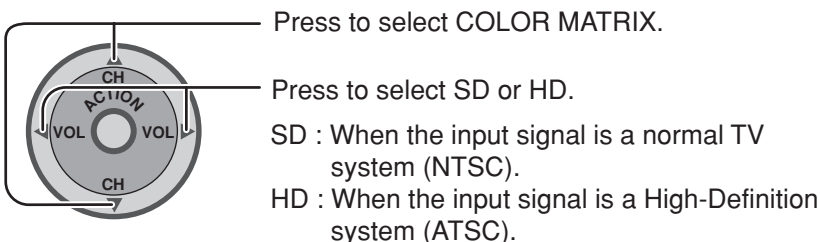

Notes:

- (1) When viewing a non-standard DTV signal format, you can change color parameters manually for the best picture quality.
- (2) COLOR MATRIX does not need to be set when using High-Definition equipment or 480i output equipment. Use only for 480p signal source.

FREEZE

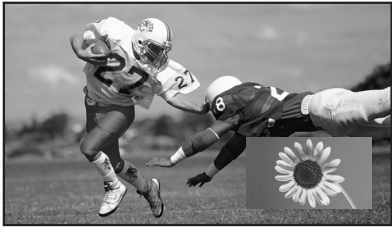
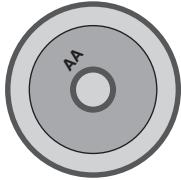

Audio Adjustment

Selecting STEREO/SAP/MONO

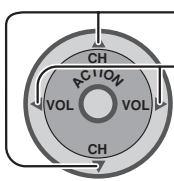

Press to select MODE.

Press to select STEREO / SAP / MONO.
Red display - Signal available
White display - Signal not available

Note:

AUDIO MODE selection is also possible by pressing the  button on the remote control (see page 21).

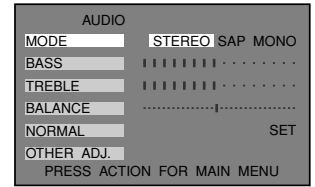

Helpful Hints:

- **STEREO** - Two channel Audio reception.
- **SAP** - Second Audio Programming (typically used for bilingual audio).
- **MONO** - Use when stereo signal is weak.

Selecting BASS / TREBLE / BALANCE / NORMAL

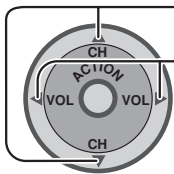

Press to select BASS / TREBLE / BALANCE / NORMAL.

Press to adjust the desired level by listening to the sound.

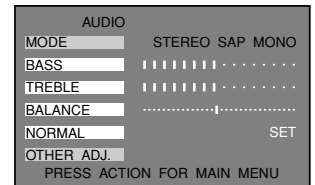

Item	Effect	Function
BASS	◀ Less ▶ More	Increase or decrease the bass response.
TREBLE	◀ Less ▶ More	Increase or decrease the treble response.
BALANCE	◀ Left SP. ▶ Right SP.	Emphasize the left / right speaker volume.
NORMAL	▶ NO	Reset BASS, TREBLE and BALANCE adjustments to factory default settings.

Selecting option menus in OTHER ADJ.

To select option menus in OTHER ADJ.

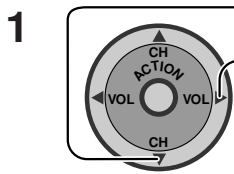

Press to select OTHER ADJ.

Press to enter option menu field.

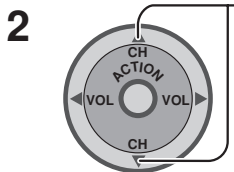

Press to select desired option menu.

Proceed to adjustments.

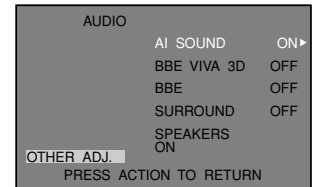
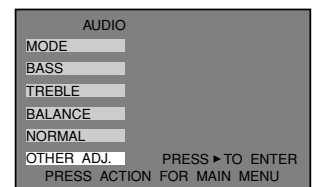

AI SOUND

AI SOUND Equalize overall volume levels across all channels. (AI sound is not available in VIDEO mode).

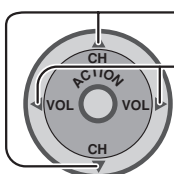

Press to select AI SOUND.

Press to select ON or OFF.
ON ↔ OFF

Note: AI SOUND is not available in VIDEO mode.

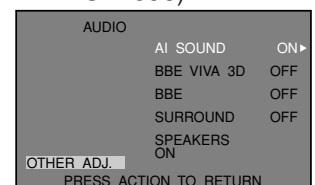

Audio Adjustment

BBE VIVA / BBE

The distinguishing feature of BBE VIVA is its maintenance of accurate audio imagery. Ordinary 3D surround systems force the sound out to the left and right, affecting the center channel. As a result it may become hard to hear people's voices, or the center audio may completely disappear. BBE VIVA reproduces vocals in music and voices in movies accurately and distinctly.

BBE VIVA This maintains a constant level of sound that is faithful to the original, producing Hi-Fi 3D sound that cannot be obtained with other types of 3D Surround.

BBE Use special signal processing to accurately reproduce the "attack" of each sound, in order to make it immediate and superbly faithful to the original, while retaining its natural feel.

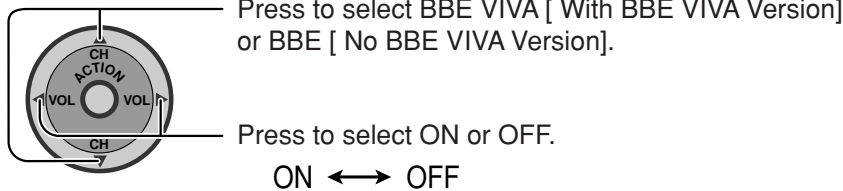

Notes:

- When "BBE VIVA" is set to ON, "BBE" and "SURROUND" setting are fixed to ON.
- When "BBE VIVA" is set to OFF, "BBE" and "SURROUND" can be set individually.

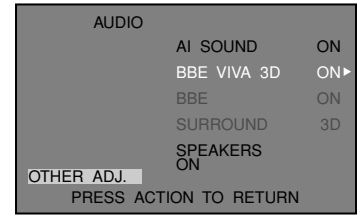

[With BBE VIVA Version]

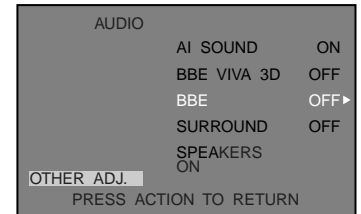

[No BBE VIVA Version]

SURROUND

To enjoy a concert hall effect, turn the SURROUND to ON. SURROUND function is effective when BBE VIVA is set to OFF.

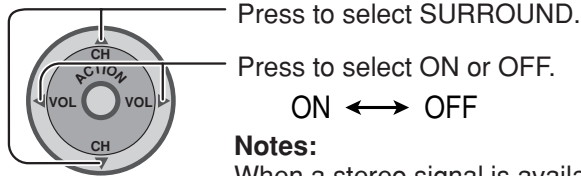

Notes:

- When a stereo signal is available : SURROUND → set to ON.
- When audio signal is monoural : SURROUND → set to OFF.

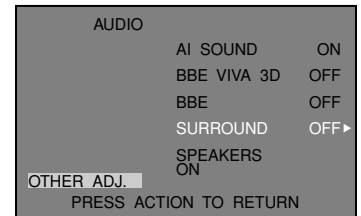

SPEAKERS

Select the desired SPEAKER mode.

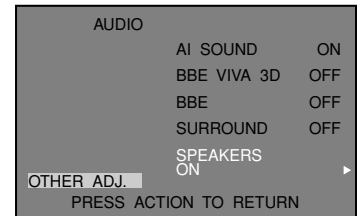
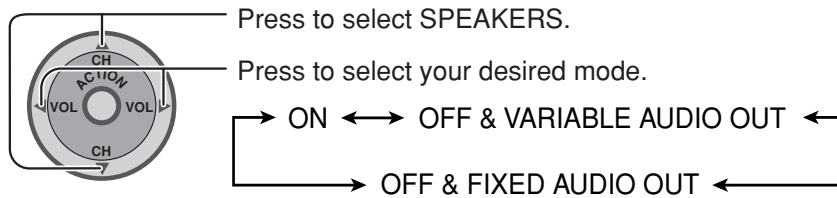

Mode	Function
ON	TV speakers operate normally.
OFF & Variable Audio Out	TV speakers off -audio adjustable by television.
OFF & Fixed Audio Out	TV speakers off -audio adjustable by the external amplifier only.

CHANNELS Adjustment

CHANNEL SCAN

Let you select the channel scanning mode either FAV or ALL.

- CHANNEL SCAN FAV** To enter up to 16 favorite channels.
- CHANNEL SCAN ALL** To scan all channels when using the CH up/down buttons.

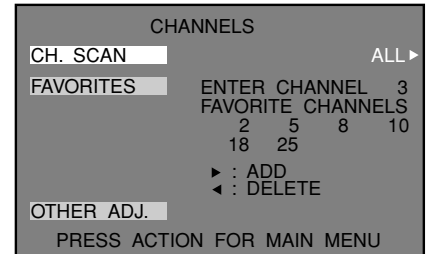
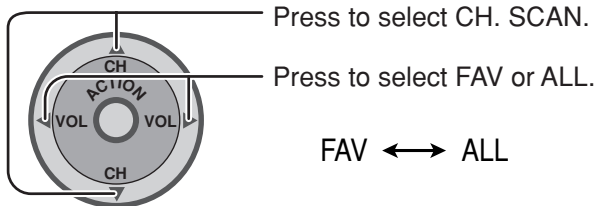

FAVORITE CHANNELS Selection

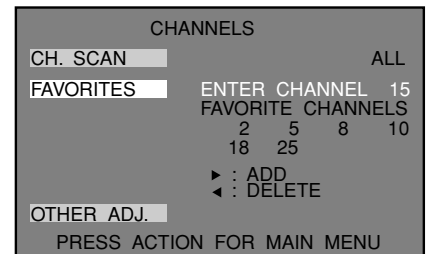
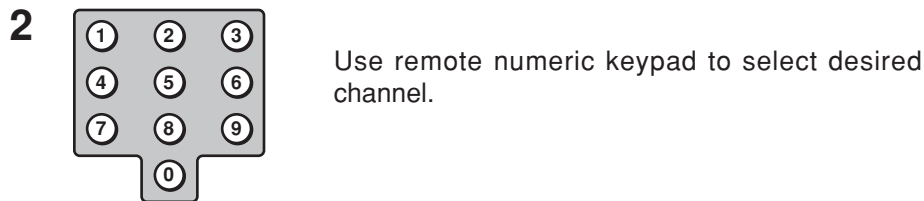
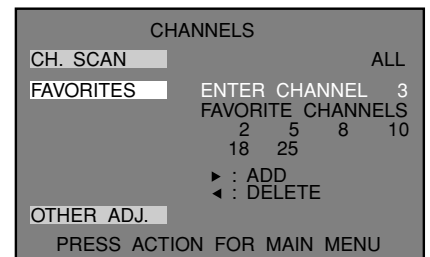
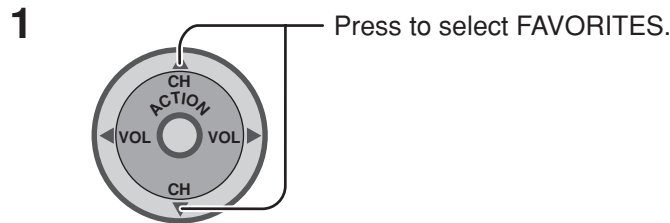

(Example: Channel 15 is selected)

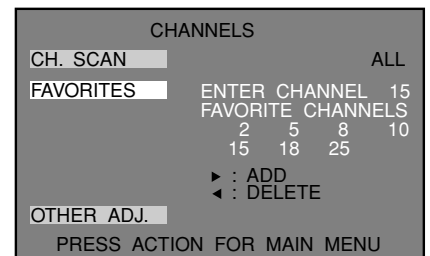
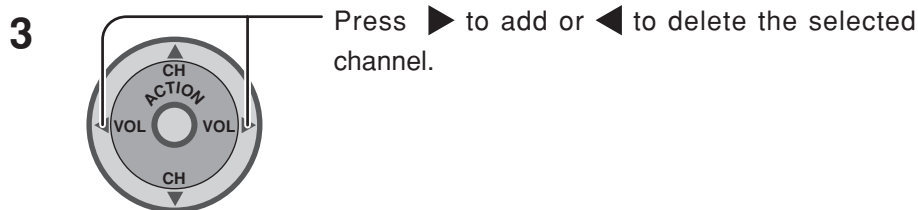

(Example: Channel 15 is added)

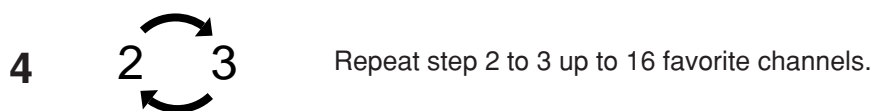

CHANNELS Adjustment

Selecting option menus in OTHER ADJ.

To select option menus in OTHER ADJ.

1

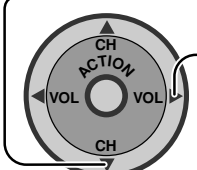

Press to select OTHER ADJ.

Press to enter option menu field.

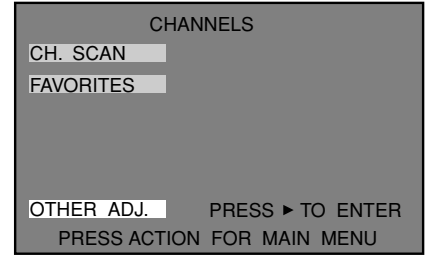

2

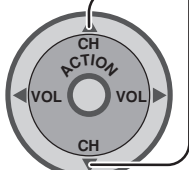

Press to select desired option menu.

↓

Proceed to adjustments.

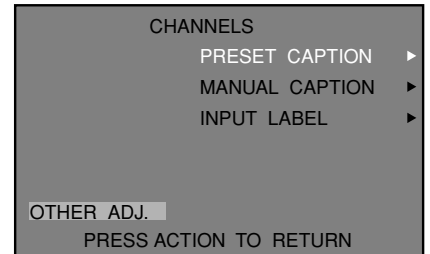

PRESET CAPTION

Assign channel numbers to pre-set popular TV stations.

1

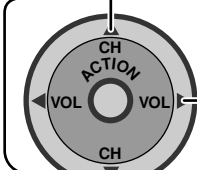

Press to select PRESET CAPTION.

Press to display next menu.

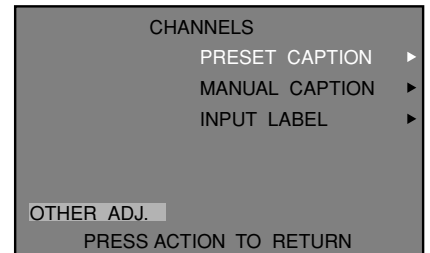

2

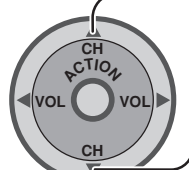

Press to select desired PRESET CAPTION.

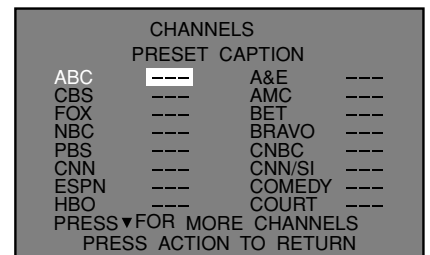

3

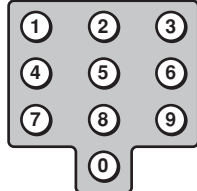

Use remote numeric keypad to select desired channel (refer to your local TV guide).

Note:
To delete a channel, press ◀ VOL while channel is highlighted.

MANUAL CAPTION

Enter channel numbers and captions manually.

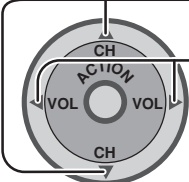
1  Press to select MANUAL CAPTION.
 Press to display next menu.

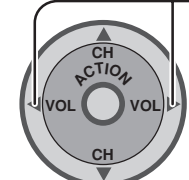
2  Press to enter desired channel.

OR

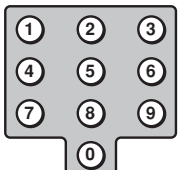
 Use remote numeric keypad to select desired channel (refer to your local TV guide).

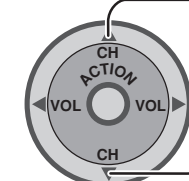
3  Press to select ENTER CAPTION.

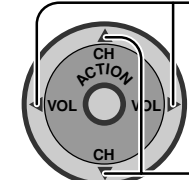
4  Press to select characters.
 Press to move cursor.

Note: Repeat Step 4 up to 4 characters.
 In MANUAL CAPTION up to 4 characters can be selected as a CAPTION.

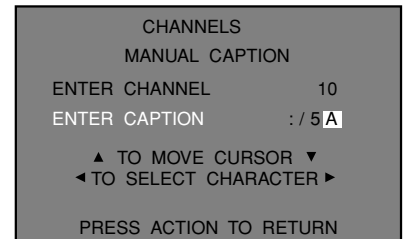
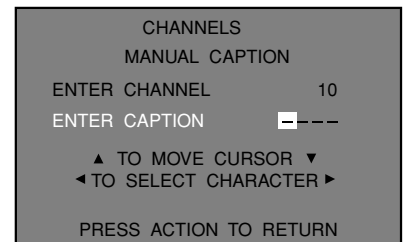
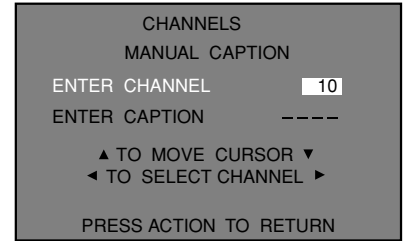
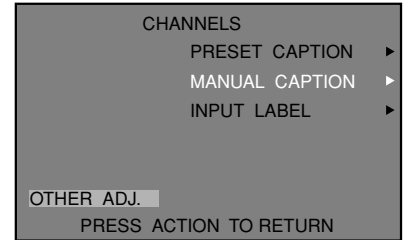

INPUT LABEL

Label video input connections to display optional equipment.

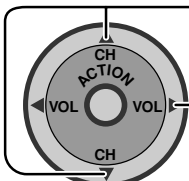
1  Press to select INPUT LABEL.
 Press to display next menu.

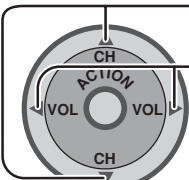
2  Press to move cursor.
 Press to select desired LABEL.

Note: To skip, select LABEL, then press ◀ VOL or VOL ▶ to select "SKIP". The selected INPUT mode will be skipped when TV/VIDEO button is pressed.

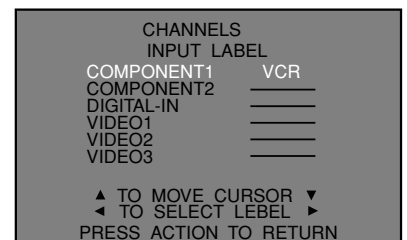
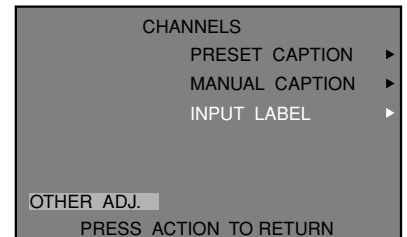

TIMER

The TIMER can switch the TV ON or OFF. Before attempting TIMER1 and TIMER2 confirm the CLOCK SET and adjust if necessary. Then set TIMER1 and TIMER2.

SLEEP

SLEEP sets the sleep time.

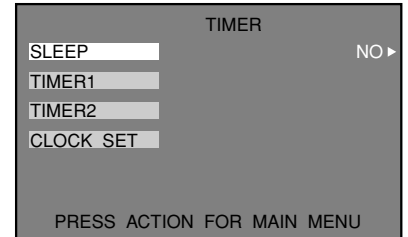
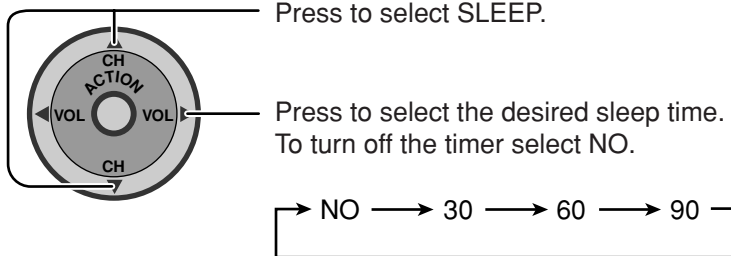

TIMER1 and TIMER2

In TIMER menu, select one or both timers to turn the television on and off at selected times, on selected channels, and on selected days. TIME must be entered in CLOCK SET to operate the TIMER features.

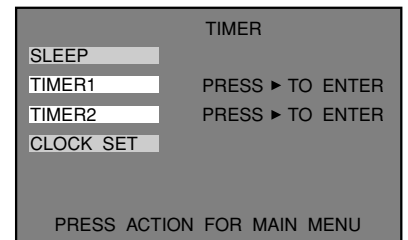
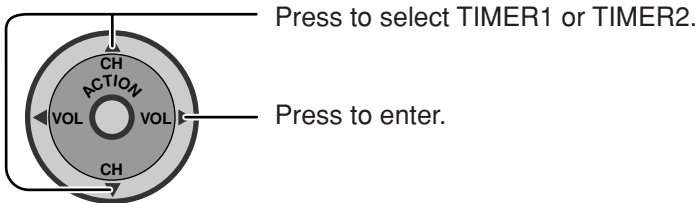

DAY Set the day of the week.

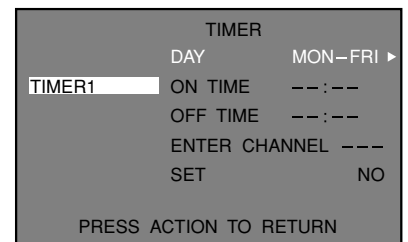
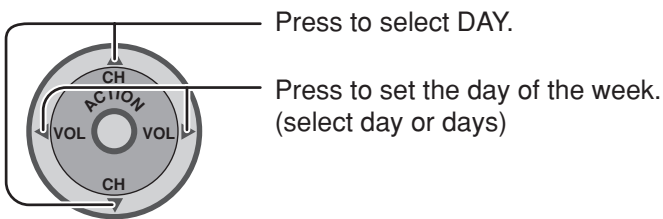

ON TIME Set the time of day.

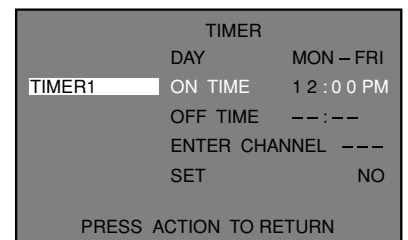
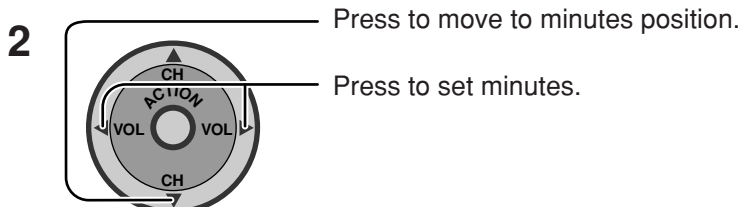
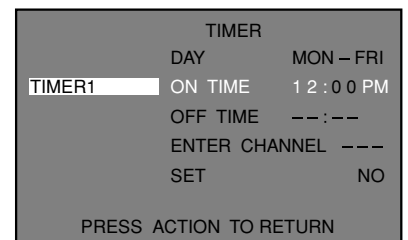
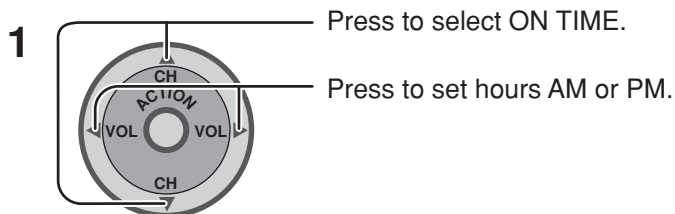

OFF TIME Set the time of day.

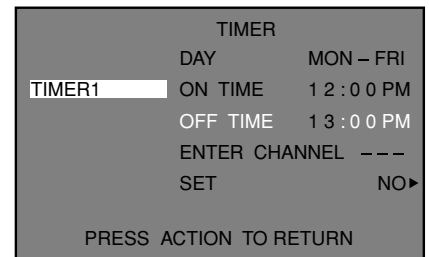
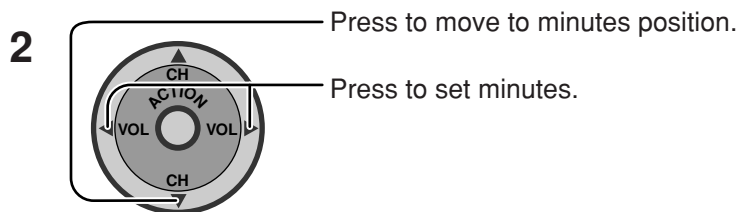
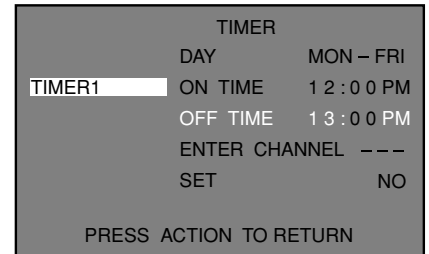
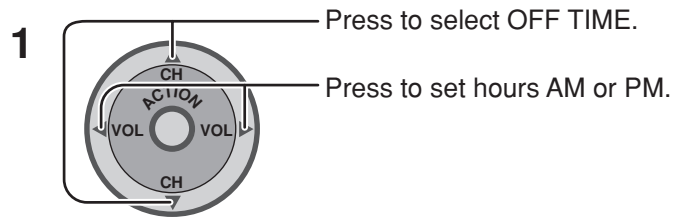

ENTER CHANNEL

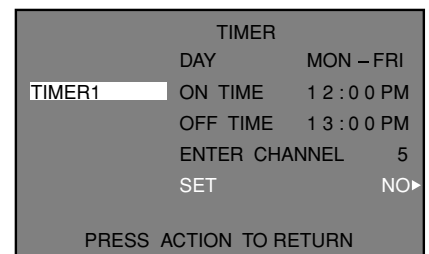
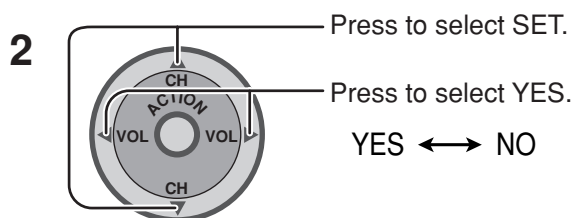
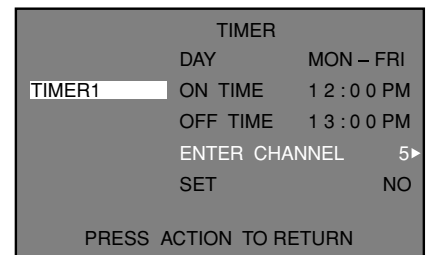
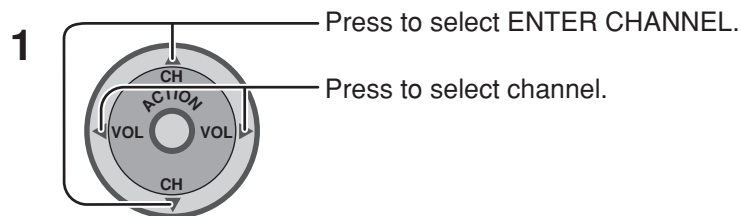

TIMER Activation

The TIMER is active when the television is OFF or ON. The television will switch to the selected channel at the selected time set in the TIMER.

Turn Off After 90 Minutes

The television automatically turns OFF after 90 minutes when turned ON by the TIMER. If the OFF time is selected or if a key is pressed, the automatic OFF after 90 minutes will be cancelled.

Notes:

- (1) When the power to the TV set is disrupted (due to a power outage or similar problem, after power is restored, the off-timer will be deactivated and the TV will be in standby mode.
- (2) To see the remaining sleep time, press the RECALL button.

CLOCK SET

1



LOCK Feature

CREATE CODE FIRST

To use LOCK options CREATE CODE FIRST.

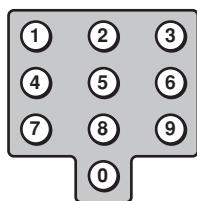

Use the remote numeric keypad to enter a four-digit secret code.

While entering a code, by pressing the up ▲ or down ▼ button you can input a new code again.

After entering your secret code for the first time, the onscreen display will change to ENTER CODE.

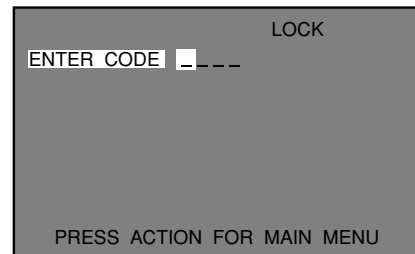
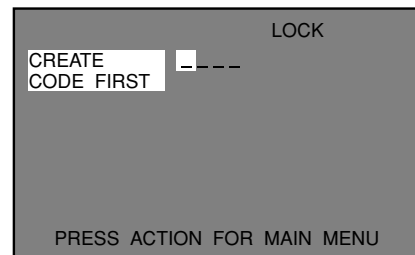

Notes:

- (1) Use a code that is easy to remember and record it in a safe place.
- (2) If you do not remember your code, LOCK will unlock in 12, 24, or 48 hours, depending on the current setup. Be cautious when selecting ALWAYS. If ALWAYS is selected, and you forget your secret code, the TV must be serviced by a qualified technician to clear the LOCK setup.

CODE

If you select CODE, and you change your code from the one used in the CREATE CODE FIRST or ENTER CODE, your new code becomes the controlling code.

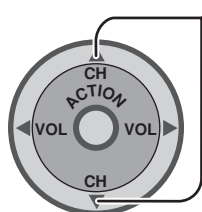

Press to select CODE.

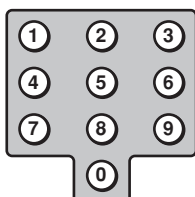

Use the remote numeric keypad to enter a four-digit secret code.

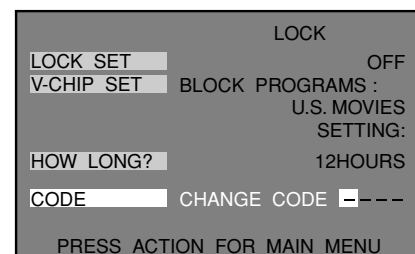

LOCK SET

Select LOCK SET to prevent video games and VCR tapes from being viewed.

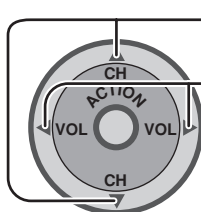

Press to select LOCK SET.

Press to select from the following.

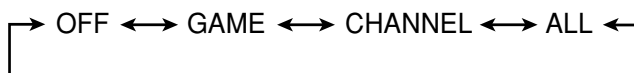

MODE	Function
OFF	Turns Lock function off.
GAME	Lock CH 3, 4 and Video inputs.
CHANNEL	Lock up to four channels.
ALL	Locks all channels and video inputs.

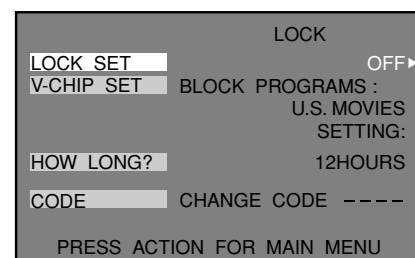

LOCK Feature

CHANNEL

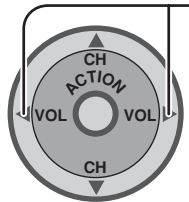
1  Press to select CHANNEL.

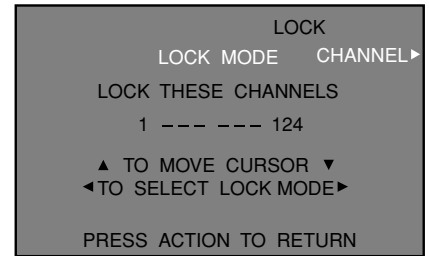

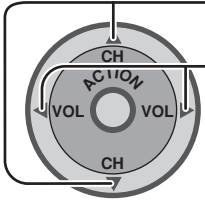
2  Press to select channel position.
Press to select channels.
(Or use remote numeric keypad to select channels.)

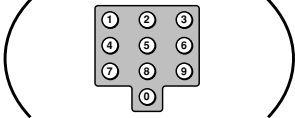
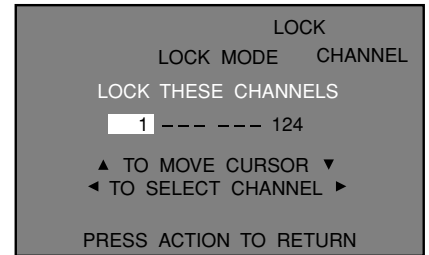



3 Repeat step 2 for up to four channels.

V-CHIP SET

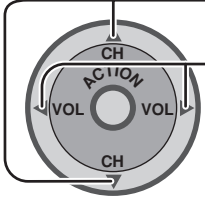
In the United States and Canada, the V-CHIP consists of two rating systems, which are MPAA (MOTION PICTURE) and TV PARENTAL GUIDELINES. Its function is to block programs by following the rating data in the XDS data packets sent from broadcasting stations. The user can select which rating programs should be blocked by using the LOCK MENU options.

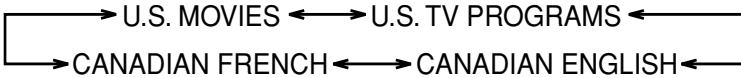
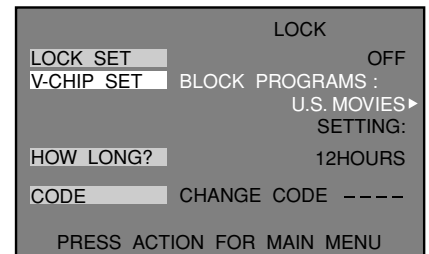
1  Press to select V-CHIP SET.
Press to select from the following.

2  Press to select SETTING.
Press to enter SETTING.

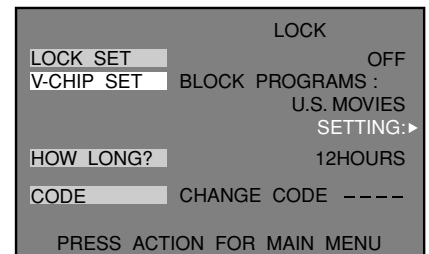

U.S. TV PROGRAMS

This TV model features the “V-Chip technology” which allows you to use U.S. TV PROGRAMS Guide ratings to block various types of TV programs. PIP will also be blocked automatically.

U.S. TV PROGRAMS RATING CHART

- 1**

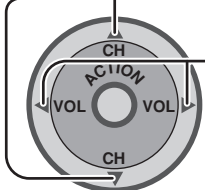

Press to select U.S. TV PROGRAMS.

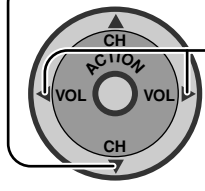

Press to select U.S. TV PROGRAMS ON or OFF.

ON ↔ OFF
- 2**

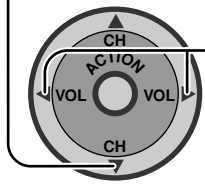

Press to select VIEW NR PROGRAMS?.

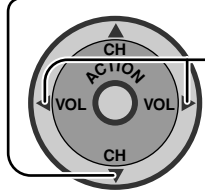

Press to select VIEW NR PROGRAMS? YES or NO.

YES ↔ NO

YES: NR programs will be received.
NO: NR programs will be blocked.
- 3**

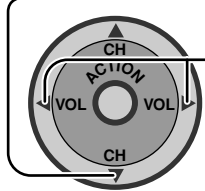

Press to select SETTING.

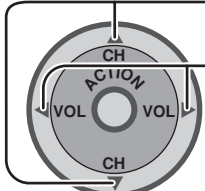

Press to select BASIC or DETAILED.

BASIC: Allows you to select only general ratings such as TV-Y, TV-PG, etc.
DETAILED: Allows you to select both general ratings and content such as V, L, etc.

Note: See Customer Caution.
- 4**

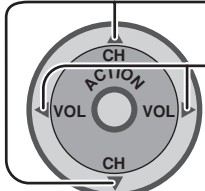

Press to move between different ratings.

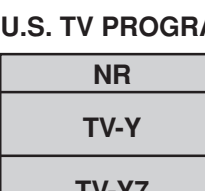

Press to select ratings you would like to block (RED) and unblock (GREEN).

Perform Step 4 for each rating.

Note: See the U.S. TV PROGRAMS RATINGS CHART.

```

LOCK
U.S TV PROGRAMS      ON
VIEW NR PROGRAMS?   YES
SETTING:             BASIC
TY-Y
TY-Y7  FV
-----
TY-G
TY-PG V S L D
TY-14 V S L D
TY-MA V S L
PRESS ACTION TO RETURN
    
```

```

LOCK
U.S TV PROGRAMS      ON
VIEW NR PROGRAMS?   YES
SETTING:             BASIC
TY-Y
TY-Y7  FV
-----
TY-G
TY-PG V S L D
TY-14 V S L D
TY-MA V S L
PRESS ACTION TO RETURN
    
```

```

LOCK
U.S TV PROGRAMS      ON
VIEW NR PROGRAMS?   YES
SETTING:             BASIC
TY-Y
TY-Y7  FV
-----
TY-G
TY-PG V S L D
TY-14 V S L D
TY-MA V S L
PRESS ACTION TO RETURN
    
```

```

LOCK
U.S TV PROGRAMS      ON
VIEW NR PROGRAMS?   YES
SETTING:             BASIC
TY-Y
TY-Y7  FV
-----
TY-G
TY-PG V S L D
TY-14 V S L D
TY-MA V S L
PRESS ACTION TO RETURN
    
```

U.S. TV PROGRAMS RATINGS CHART

NR	Not Rated. SEE CUSTOMER CAUTION on the next page.
TV-Y	All children. The themes and elements in this program are specifically designed for a very young audience, including children from ages 2-6.
TV-Y7	Directed to older children. Themes and elements in this program may include mild physical or comedic violence, or may frighten children under the age of 7.
TV-G	General audience. It contains little or no violence, no strong language, and little or no sexual dialogue or situations.
TV-PG	Parental guidance suggested. The program may contain infrequent coarse language, limited violence, some suggestive sexual dialogue and situations.
TV-14	Parents strongly cautioned. This program may contain sophisticated themes, sexual content, strong language and more intense violence.
TV-MA	Mature audiences only. This program may contain mature themes, profane language, graphic violence, and explicit sexual content.
FV	FANTASY/CARTOON VIOLENCE
V	VIOLENCE
S	SEX
L	OFFENSIVE LANGUAGE
D	DIALOGUE WITH SEXUAL CONTENT

LOCK Feature

Customer Caution

The V-Chip system that is used in this set is capable of blocking "NR" programs (non rated, not applicable and none) per FCC Rules Section 15.120(e)(2). If the option of blocking "NR" programs is chosen "unexpected and possibly confusing results may occur, and you may not receive emergency bulletins or any of the following types of programming:"

- Emergency Bulletins (Such as EAS messages, weather warnings and others)
- Locally originated programming • News • Political • Public Service Announcements • Religious • Sports
- Weather

U.S. MOVIES

This TV model features the "V-Chip technology" which allows you to use Motion Picture Ratings when viewing movies or video tapes. This innovation allows parents to block various types of movies and video tapes at their discretion. PIP will also be blocked automatically.

U.S. MOVIES RATING CHART

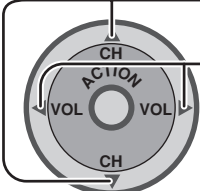
- 

Press to select U.S. MOVIES.

Press to select U.S. MOVIES ON or OFF.

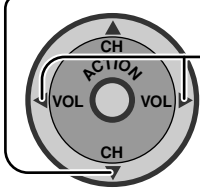
ON ↔ OFF
- 

Press to select VIEW NR MOVIES?.

Press to select VIEW NR PROGRAMS? YES or NO.

YES ↔ NO

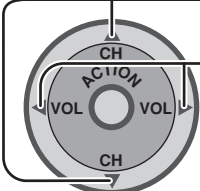
Note:
Some movies are not rated for a variety of reasons. Old movies and foreign films are usually not rated.
- 

Press to move between different ratings.

Press to select ratings you would like to block (RED) and unblock (GREEN).

Continue Step 3 for each ratings.

Note: See the U.S. MOVIES RATINGS CHART.

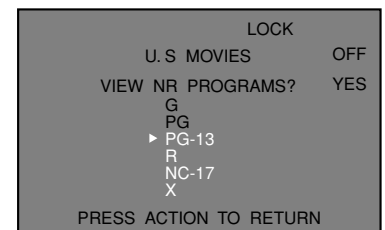
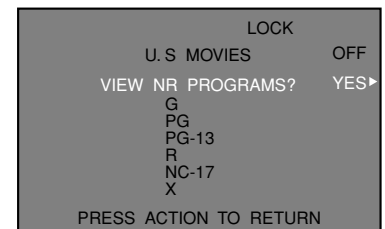
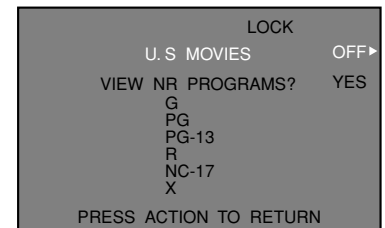

PG-13, R, NC-17 and X will be blocked.

U.S. MOVIES RATINGS CHART

NR	CONTAINS NO RATING (NOT RATED) AND NA (NOT APPLICABLE) PROGRAMS. Movie has not been rated or rating does not apply.
G	GENERAL AUDIENCES. All ages admitted.
PG	PARENTAL GUIDANCE SUGGESTED. Some material may not be suitable for children.
PG-13	PARENTS STRONGLY CAUTIONED. Some material may be inappropriate for children under 13.
R	RESTRICTED. Under 17 requires accompanying parent or adult guardian.
NC-17	NO ONE 17 AND UNDER ADMITTED.
X	ADULTS ONLY.

Canadian English

The V-CHIP used in this TV model allows you to block various types of movies and television programs based on the two rating systems used in Canada. PIP will also be blocked automatically.

1

Press to select CANADIAN ENGLISH.

Press to select CANADIAN ENGLISH ON or OFF.

ON ↔ OFF

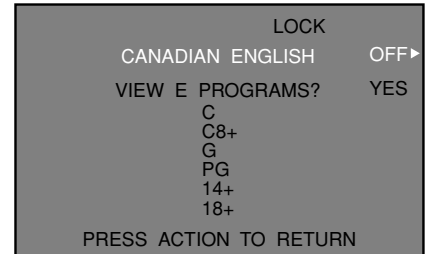

2

Press to select VIEW E PROGRAMS?

Press to select VIEW E PROGRAMS? YES or NO.

YES ↔ NO

Note:
E (Exempt) programming includes: news, sports, documentaries and other information programming, talk shows, music videos, and variety programming.

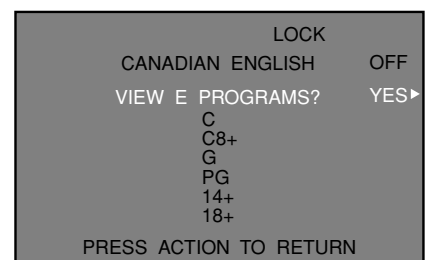

3

Press to move between different ratings.

Press to select ratings you would like to block (RED) and unblock (GREEN).

Note: See the CANADIAN ENGLISH RATING CHART.

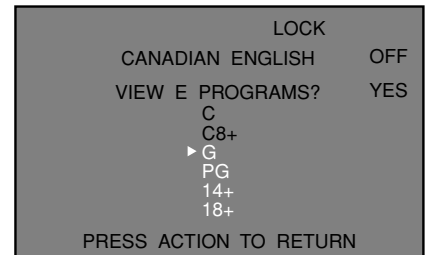

CANADIAN ENGLISH RATINGS CHART

E	Exempt - Exempt programming includes: news, sports, documentaries and other information programming, talk shows, music videos, and variety programming.
C	Programming intended for children under age 8. No offensive language, nudity or sexual content.
C8+	Programming generally considered acceptable for children 8 years and over. No profanity, nudity or sexual content.
G	General programming, suitable for all audiences.
PG	Parental Guidance suggested. Some material may not be suitable for children.
14+	Programming contains themes or content which may not be suitable for viewers under the age of 14. Parents are strongly cautioned to exercise discretion in permitting viewing by pre-teens and early teens.
18+	ADULTS ONLY

Canadian French

The V-CHIP used in this TV model also lets you block or unblock Canadian French programs according to various ratings categories. PIP will also be blocked automatically.

1

Press to select CANADIAN FRENCH.

Press to select CANADIAN FRENCH ON or OFF.

ON ↔ OFF

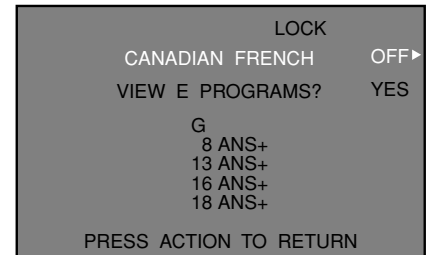

2

Press to select VIEW E PROGRAMS?

Press to select VIEW E PROGRAMS? YES or NO.

YES ↔ NO

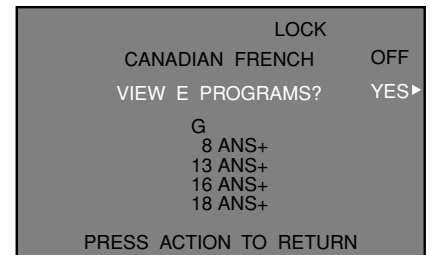

Note:
E (Exempt) programming includes: news, sports, documentaries and other information programming, talk shows, music videos, and variety programming.

3

CANADIAN FRENCH RATINGS CHART

E	Exempt - Exempt programming.
G	General - Programming intended for audience of all ages. Contains no violence, or the violence content is minimal or is depicted appropriately.
8 ANS+	8+ General - Not recommended for young children. Programming intended for a broad audience but contains light or occasional violence. Adult supervision recommended.
13ANS+	Programming may not be suitable for children under the age of 13 - Contains either a few violent scenes or one or more sufficiently violent scenes to affect them. Adult supervision strongly suggested.
16ANS+	Programming may not be suitable for children under the age of 16 - Contains frequent scenes of violence or intense violence.
18ANS+	18 ans +Programming restricted to adults. Contains constant violence or scenes of extreme violence.

Blocking Message

If V-Chip is enabled and the program exceeds the rating limit set by you, the blocking message will appear and the audio will be muted. Enter your four-digit secret code if you wish to continue viewing the program. After entering your code, all locks and rating blocks are disabled until the TV is turned off or until all settings are off.

Note:

If you enter your four-digit secret code to override rating blocks, you must reset all rating blocks by either reprogramming or turning the TV off.

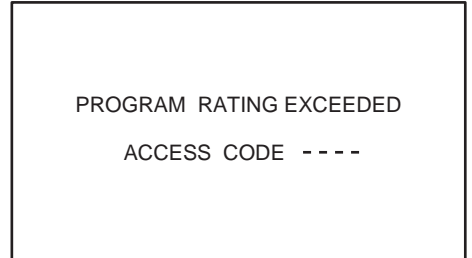

Split Screen Blocking Message

Split Screen function is available when V-Chip is activated. If the program being viewed in Split Screen exceeds the set rating limit, Split Screen will disappear and a blocking message will be displayed.

Note:

Enable Split Screen functions by setting Lock Set, U.S. TV PROGRAM, U.S. MOVIES, CANADIAN ENGLISH and/or CANADIAN FRENCH to OFF.

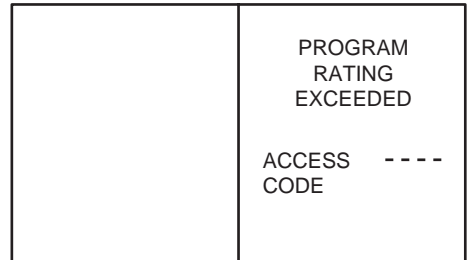

PIP Blocking Message

PIP function is available when V-Chip is activated. If the program being viewed in PIP exceeds the set rating limit, PIP will disappear and a blocking message will be displayed.

Note:

Enable PIP functions by setting Lock Set, U.S. TV PROGRAM, U.S. MOVIES, CANADIAN ENGLISH and/or CANADIAN FRENCH to OFF.

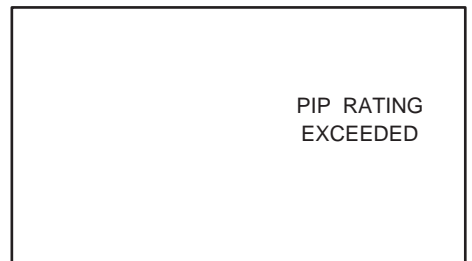

HOW LONG?

After setting the LOCK SET and V-CHIP SET, set the blocking hours.

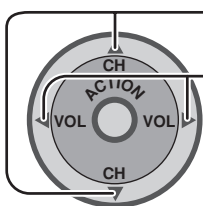

Press to select HOW LONG?

Press to select 12HOURS/24HOURS/48HOURS / ALWAYS.

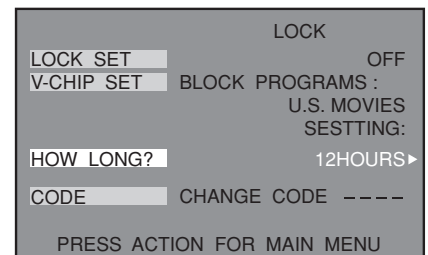
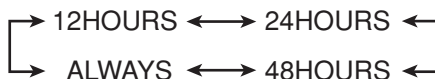

Picture In Picture Operation



This television has a Picture In Picture (PIP) feature. This allows you to watch two (2) live broadcasts at the same time with one video source such as a VCR, cable box, etc.

Basic PIP Operation

- 1  Press the PIP button on the remote control to display the PIP Frame on screen.

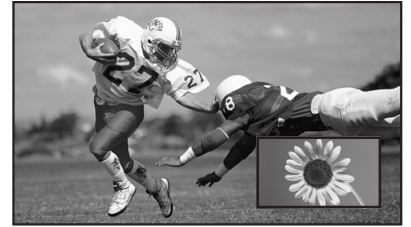
Note:
Audio is from Main Picture only.

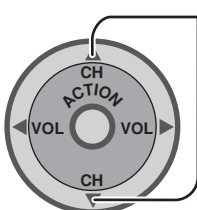

- 2  Select channels for the PIP frame by pressing .

- 3  Press to select channel for the Main Picture.
or
Use the remote control numeric keypad.

Main Picture

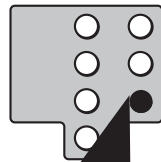

Picture-in-Picture Frame

- 4  Press to view picture source status.

Press  again to cancel the PIP Frame.

Switch the PIP and MAIN PICTURE source.

Picture in Picture Operation

PIP MIN, PIP MAX

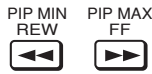

These features are used to size PIP Frame.

Press or to size the PIP Frame.

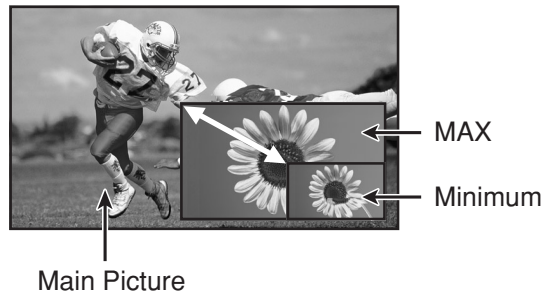

Freeze



During PIP operation this feature is used to stop action in PIP frame.

1 Press to stop PIP frame action.

2 Press again to continue action.

Note:

To stop action for Main picture:

1 In PICTURE MENU OTHER ADJ, select FREEZE PIP or SPLIT (see page 30).

2 Press while PIP frame is not displayed.

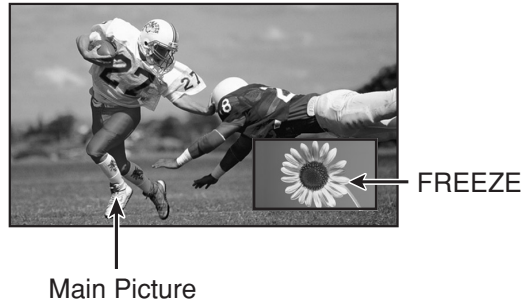

TV/VIDEO Button



Press when PIP frame is displayed to select desired input mode.

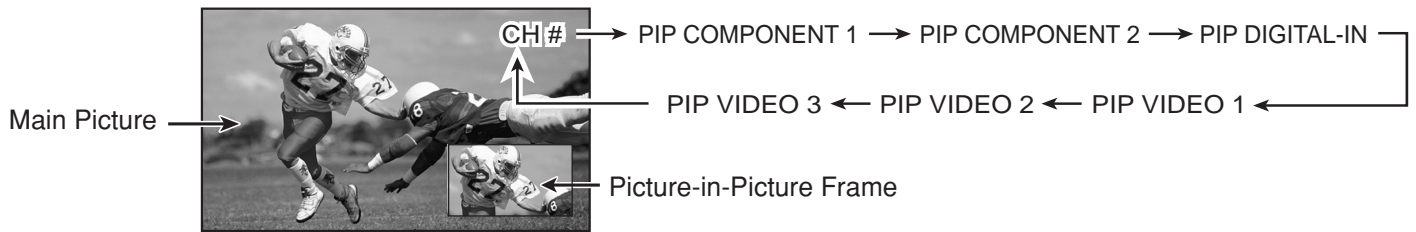

Search



This feature lets you scan through all available channels.

1 Press to display search frames.

2 Press again to stop search feature. This returns the screen to the previous condition (single screen, PIP screen or SPLIT screen).

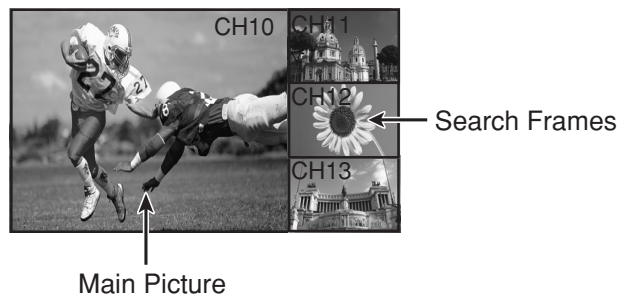

Move



This feature is used to move PIP frame to one of four corners.

Press to position PIP frame to desired corner.

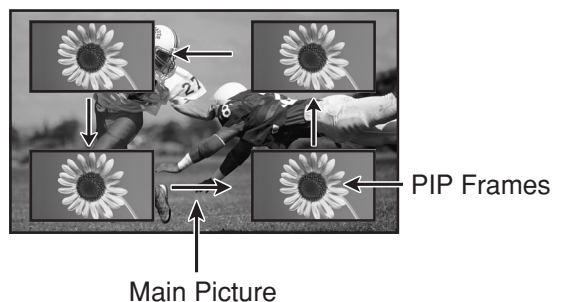

Split Screen

This feature lets you watch two different channels side by side with or without an external video source. The audio is from the Main picture only (left side). Split screen enables you to search other channels on the right screen or check video recording status.

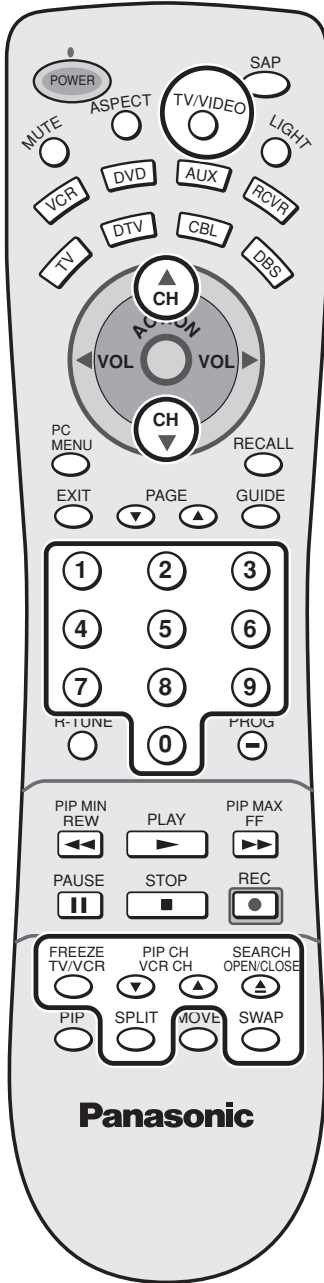

Splitting the screen

- 1 Press **SPLIT** to display Split screen.



- 2 Returning to one screen.
Press **SPLIT** again to return.



Freezing pictures

During Split Screen this feature is used to stop action in SPLIT screen.

- 1 Press **FREEZE TV/VCR** to stop action in SPLIT screen.



- 2 Press **FREEZE TV/VCR** again to recover.

Note:

To stop action for Main picture:

- 1 In PICTURE MENU OTHER ADJ, select FREEZE PIP or SPLIT (see page 30).
- 2 Press **FREEZE TV/VCR** while SPLIT frame is not displayed.

Notes:

- (1) Sound from the left screen is output from the speakers on the TV set (and headphone jack).
- (2) When the screen is split, signals of the left screen are output from the rear monitor output terminal.
- (3) The left and right screens are processed by individual circuits, and therefore, may have slight variation in image quality.
- (4) Split screen returns to single screen when the TV is turned off.
- (5) The right and left screens cannot display the same picture at the same time.

Changing the channels for the Split Screen

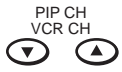

Select channels for the Split Screen by pressing .



Changing the channels for the Main Picture

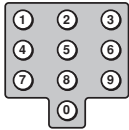

Select channels for the Main Picture by pressing or use the remote control numeric keypad.

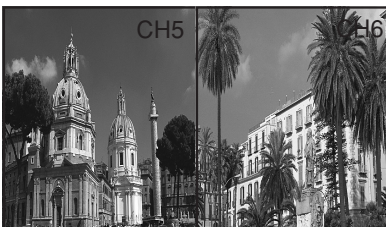
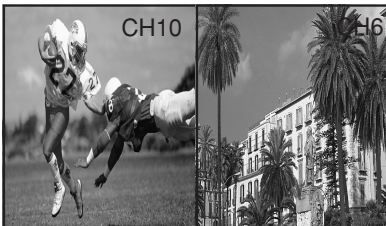

Swapping left and right screens



Press to switch the SPLIT SCREEN and MAIN PICTURE source.



Viewing Videos



While Split screen is displayed, press to switch modes.

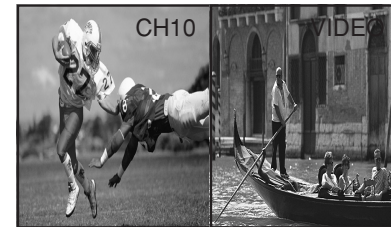

Searching the other channels



Press to search the other channels.

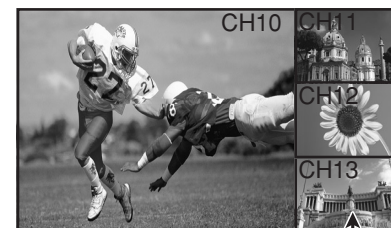

Search Frames

Press again to stop the search.

This returns the screen to its previous condition.

ASPECT Controls

The color monitor will allow you to enjoy viewing the picture at its maximum size, including wide screen cinema format picture.

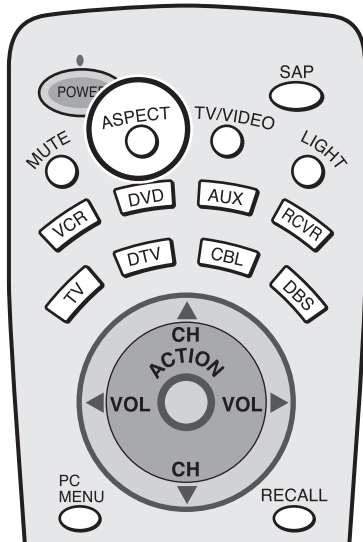

ASPECT button

The aspect mode changes each time the ASPECT button is pressed.

Note: Aspect MODE will change as follows depending on the receiving signals.

(1) 480i:

(2) 480p (including DIGITAL-IN):

(3) PC mode

(4) 1080i:

(5) SPLIT SCREEN:



FULL only

FULL only

Mode	Picture	Explanation
4 : 3		4 : 3 will display a 4:3 picture in its true aspect ratio. Bars can be seen to the left and right of the image.
ZOOM		ZOOM mode magnifies the central section of the picture.
FULL		FULL will display the picture at its maximum size but with slight elongation.
JUST		JUST mode will display a 4:3 picture at its maximum size but with aspect correction applied to the sides of the screen so that elongation is only apparent at the left and right edges of the screen. The size of the picture will depend on the original signal.

Note:

The S VIDEO terminal on this set can be detected specially encoded signals that are compatible with a wide screen monitor. When a full image from the S VIDEO terminal of specially encoded video is detected by the set, the screen size is automatically set to FULL mode.

PC MENU

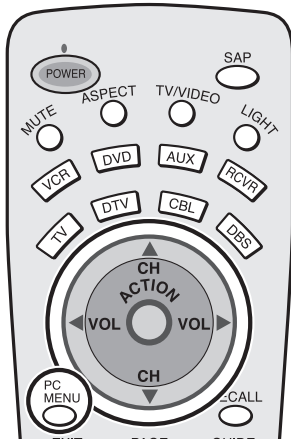

1 Press to display the PC menu.

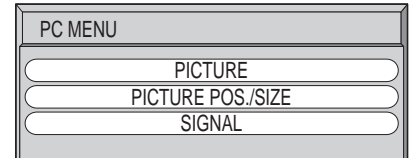

2 Press to select PICTURE/PICTURE POS./SIZE/SIGNAL.
Press to display each menu screen.

To PICTURE adjust menu
(see on this page below)

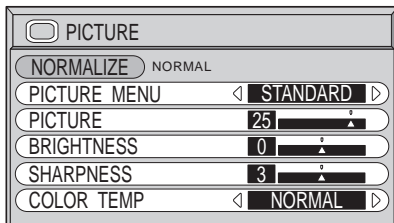

To PICTURE POS./SIZE
adjust menu
(see page 52)

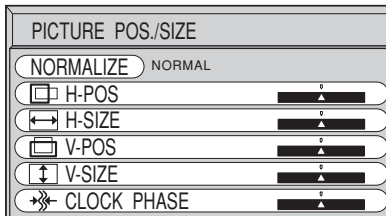

To SIGNAL screen
(see page 53)

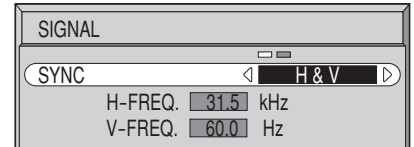

PICTURE Adjustments

- 1 Select PICTURE from "PC MENU" during PC input signal.
- 2 Select to adjust each item.

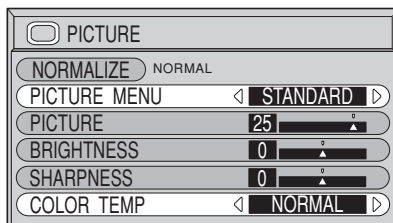
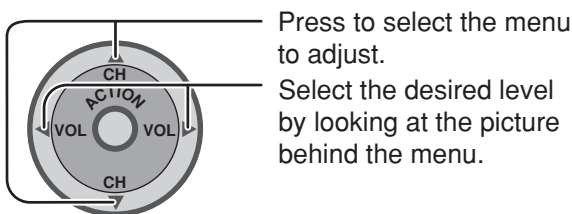

Press the left ◀ or right ▶ button to switch between modes.



Press the left ◀ or right ▶ button to switch between modes.

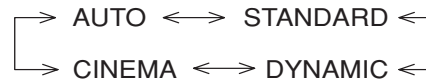

AUTO

Automatically selects the mode that best suits the brightness of the environment.

STANDARD

For viewing in standard (evening lighting) environments. This menu selects the normal levels of BRIGHTNESS and PICTURE.

DYNAMIC

For viewing in brighter environments. This menu selects higher than normal levels of BRIGHTNESS and PICTURE.

CINEMA

Ideal for movies.

Note:

If you would like to change the picture and color of the selected PICTURE MENU to something else, adjust using the items in the PICTURE menu. (see next page)

PC MENU

Item	Effect	Function
PICTURE	Less More	Selects the proper brightness and density for the room.
BRIGHTNESS	Darker Brighter	Adjusts for easier viewing of dark pictures such as night scenes and black hair.
SHARPNESS	Less More	Adjusts picture sharpness.

Notes:

- (1) You can change the level of each function (PICTURE, BRIGHTNESS, SHARPNESS) for each PICTURE MENU.
- (2) In PICTURE, there is not a noticeable change even when PICTURE is increased with a bright picture or reduced with a dark picture.

Adjusting PICTURE POSITION/SIZE

Adjusting screen

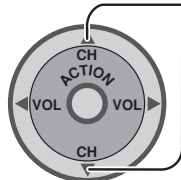
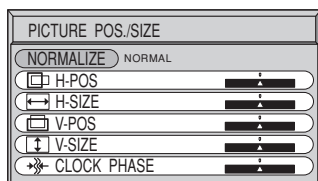
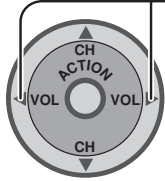
- 1 Select PICTURE POS./SIZE from the "PC MENU" during PC input signal.
- 2  Press to select H-POS/H-SIZE/V-POS/V-SIZE/CLOCK PHASE.
During "RGB" input signal.

- 3  Press to adjust POS./SIZE.

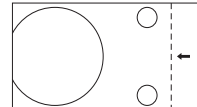
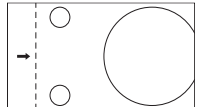
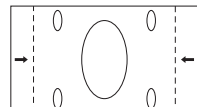
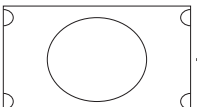
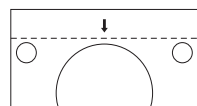
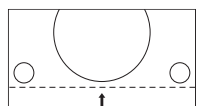
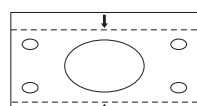
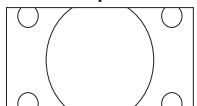
Note:
If a "Cue" or "Rew" signal from a VCR or DVD player is received, the picture position will shift up or down. This picture position movement cannot be controlled by the PICTURE POS./SIZE function.

H-POS		When the Position Left "◀" button is pressed.		When the Position Right "▶" button is pressed.
H-SIZE		When the Position Left "◀" button is pressed.		When the Position Right "▶" button is pressed.
V-POS		When the Position Left "◀" button is pressed.		When the Position Right "▶" button is pressed.
V-SIZE		When the Position Left "◀" button is pressed.		When the Position Right "▶" button is pressed.
CLOCK PHASE (RGB/PC in Mode)	Flickering and distortion can be eliminated by using the Position Left "◀" or Right "▶" button to carry out adjustment.			



Helpful Hint (Normalization)

While the "PICTURE" or "PICTURE POS./SIZE" menu is displayed, if either the N button on the remote control is pressed at any time or the  (ACTION button) is pressed during "NORMALIZE", then all adjustment values are returned to the factory settings.

SYNC

Select SIGNAL from the “PC MENU” menu during PC input signal.

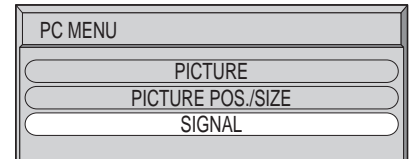

↓ Press **⏏** (ACTION) button

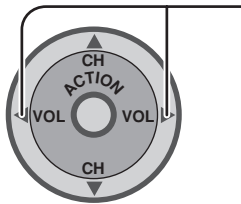

Press to select each item.

Note:
Sync cannot be adjusted while a DVI signal is being applied.

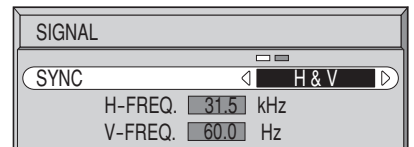

Setting RGB sync signal

Confirm that the input is set to RGB INPUT (this setting is valid only for RGB INPUT signal).

- H & V: The H and V sync signals are input from the HD/VD connector.
- ON G: Uses a synchronized signal on the Video G signal, which is input from the G connector.

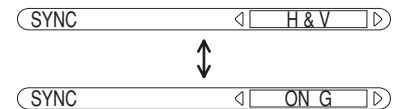

H-FREQ. (kHz)/V-FREQ. (Hz)

Displays the H (Horizontal)/V (Vertical) frequencies.

This display is valid only for RGB input signal.

Display range:

- Horizontal 15 - 110 kHz
- Vertical 48 - 120 Hz

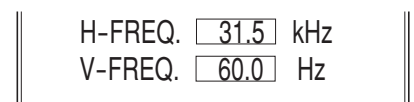

Operating peripheral equipment using the remote control

Programming The Illuminated Remote Control Using Access Codes

The Universal Remote Control can be programmed to operate many manufacturers' components, using the component function buttons for VCR, DVD, AUX, RCVR, TV, DTV CABLE or DBS. Follow the procedures for programming your Remote Control with or without a code for the component.

Determine the manufacturer of the component and look in the table for the code.

1 Confirm that the external component is plugged in and operating.

2 Turn the component off.

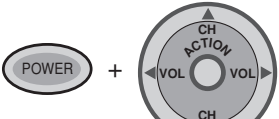
3  Press **POWER** and **ACTION** together, **for at least 5 seconds**. After 5 seconds, all the illuminated mode keys will begin to flash. Release the **POWER** and **ACTION** keys.

4  Press the mode key. The mode key will illuminate steadily, all others will go out.

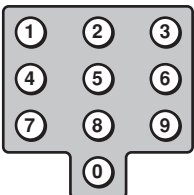
5  Enter the 3-digit component code using the Remote Control numeric keypad.

6  Press the Remote Control  to test the component. If the procedure is successful, the component will turn on.

Default Modes For Remote Control

Device	Operates	Default
TV	TV (Panasonic Only)	Panasonic TV Codes
DTV	DTV (Panasonic Only)	Panasonic DTV Codes
CABLE	CABLE (Preset)	Panasonic CABLE Codes
DBS	DBS (Preset)	Panasonic DBS Codes
VCR	VCR (Preset)	Panasonic VCR Codes
DVD/CD	DVD and CD (Preset)	Panasonic DVD Codes
AUX	Personal Video Recorders, Tape and VCR2	Panasonic Personal Video Recorders Code
RCVR	Audio Receiver (Preset)	Panasonic RCVR Code

Helpful Hints: Unsuccessful Code

If the component does not operate with the Remote Control, repeat the procedure using another code. (Some brands have multiple codes). If an incorrect code is entered, or if the procedure takes longer than 30 seconds, the programming will fail.

Programming Without A Code (When the code is not known)

This procedure searches all codes and is called the “sequence method.”

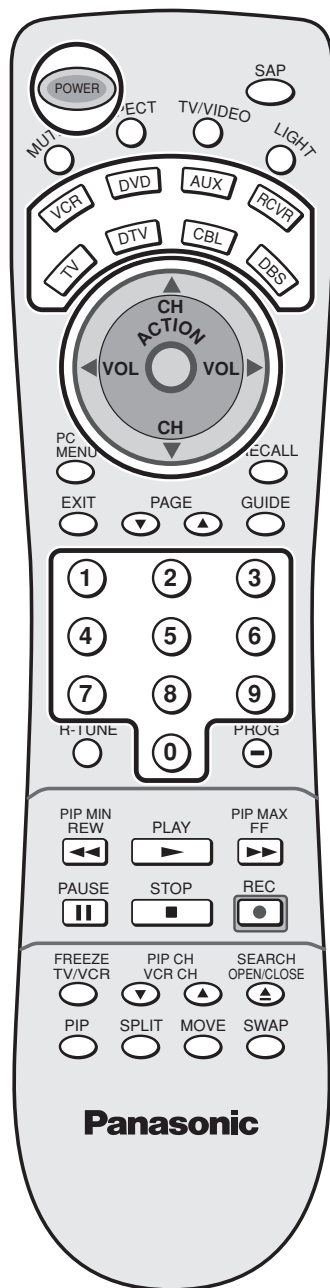

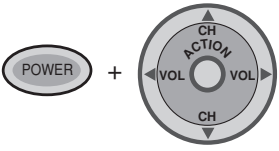

1 Confirm that the external component is plugged in and on.

2 Turn the component off.

3  Press **POWER** and **ACTION** together, for at least **5 seconds**. After 5 seconds, all the illuminated mode keys will begin to flash. Release the **POWER** and **ACTION** key.

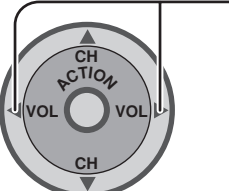
4  Press the mode key. The mode key will illuminate steadily, all others will go out.

5  Press to move forward to the next code, or to move backward.

6  Press the Remote Control  to test the component. If the procedure was successful, the component will turn on.

Note:

Repeat the above steps until the component code is found. It may take many attempts before the correct code is found.

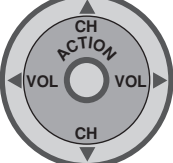
7  After the code is found, press **ACTION** to store the code.

Note:

The step and set mode will start from the current device (not the beginning of the list, except for the first time).

Operating peripheral equipment using the remote control

Infrared Codes Index

The remote control is capable of operating many brands of peripheral equipment. Refer to pages 54 and 55 for programming procedures.

Note: The remote control memory is limited and therefore some models may not operate. The remote control is not designed to control all features available in all models.

Note: After entering the proper infrared code, press the desired Mode Selection Button on the remote control. Refer to pages 20 and 59 - 60 for details on operating peripheral equipment using the remote control.

Infrared Remote Codes for Specific Components

Helpful Hint: Write down the code numbers for your components in the space provided below. This will serve as a handy reference whenever you need to reprogram your remote control.

VCR <input type="text"/> <input type="text"/> <input type="text"/>	DVD <input type="text"/> <input type="text"/> <input type="text"/>	DVD (CD) <input type="text"/> <input type="text"/> <input type="text"/>	AUX (VCR 2) <input type="text"/> <input type="text"/> <input type="text"/>	AUX (TAPE) <input type="text"/> <input type="text"/> <input type="text"/>
RECEIVER <input type="text"/> <input type="text"/> <input type="text"/>	DTV <input type="text"/> <input type="text"/> <input type="text"/>	CABLE <input type="text"/> <input type="text"/> <input type="text"/>	DBS <input type="text"/> <input type="text"/> <input type="text"/>	Other Component <input type="text"/> <input type="text"/> <input type="text"/>

Codes for VCR

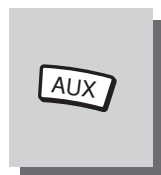

Brand	Code
Admiral	335
Aiwa	332
Akai	314, 315, 316, 329
Audio Dynamic	311, 339
Bell &Howell	305, 313
Broksonic	320, 326
Canon	323, 325
Citizen	306
Craig	305, 306, 329
Curtis Mathes	324, 345
Daewoo	301, 324, 343
DBX	310, 311, 339
Dimensia	345
Emerson	303, 319, 320, 325, 326, 343
Fisher	305, 307, 308, 309, 313
Funai	320, 326, 334
GE	324, 333, 345
Goldstar	306
Gradiente	334
Hitachi	300, 323, 345
Instant Replay	323, 324
Jensen	339
JVC	310, 311, 334, 339
Kenwood	306, 310, 311, 339
LXI	300, 305, 306, 307, 308, 309
Magnavox	323, 324, 331
Marantz	310, 311, 339
Marta	306
Memorex	309, 324
MGA	338, 340, 341, 347, 348
Minolta	300, 345
Mitsubishi	338, 340, 341, 347, 348
Multitech	304, 347
NEC	310, 311, 334, 339
Olympic	323, 324
Optimus	306, 321, 328, 335

Brand	Code
Orion	320, 326
Panasonic	321, 322, 323, 324
J.C.Penney	300, 305, 310, 311, 324, 339, 345
Pentax	300, 311, 345
Philco	320, 323, 324, 326, 331, 343
Philips	323, 324, 331
Pioneer	323
Proscan	300, 301, 302, 323, 324, 331, 333, 345, 346
Quasar	321, 322, 323, 324
Radio Shac	305, 309, 324, 333, 336, 340
RCA	300, 301, 302, 323, 324, 331, 333, 345, 346
Realistic	305, 309, 324, 336, 340
Samsung	302, 304, 333
Sansui	320, 326, 339, 352
Sanyo	305, 309, 313
Scott	301, 302, 304, 309, 320, 326, 338, 340, 347, 348
Sears	300, 305, 306, 307, 308
Sharp	335, 336
Shintom	317
Signature 2000	335
Singer	317
Sony	328, 329, 330
Sylvania	323, 324, 331
Tashiro	306
Tatung	310, 311, 339
Teac	310, 311, 339
Technics	321, 322, 323, 324
Teknika	324
Toshiba	301, 346
Vector Research	311
Wards	306, 309, 335, 336, 344
Yamaha	305, 310, 311, 339
Zenith	306, 344

Operating peripheral equipment using the remote control

DVD

Codes for DVD

Brand	Code
Denon	100
Ferguson	101
JVC	109
Mitsubishi	105
Nordmende	101
Panasonic	100
Philips	103
Pioneer	102
RCA	101

Brand	Code
Saba	101
Samsung	110
Sharp	108
Sony	104
Technics	100
Thomson	101
Toshiba	103
Yamaha	100
Zenith	107

DVD

Codes for CD

Brand	Code
Admiral	226
Aiwa	233, 235
Carver	229
Denon	242
Emerson	239
Fisher	205
Harman/Kardon	219, 220, 221, 223
Hitachi	207
Jensen	234
JVC	240, 241, 245
Kardon	223
Kenwood	200, 201, 211, 245
LXI/Sears	236
Magnavox	229, 232
Marantz	229
McIntosh	221
Nakamichi	210
Onkyo	214, 215

Brand	Code
Optimus	208, 218, 220, 222
Panasonic	224, 225, 227
Philips	229, 230
Pioneer	208
Quasar	224, 225, 227
RCA	231, 237, 238, 247
Sansui	210, 246
Sanyo	205
Scott	210, 246
Sharp	242, 243
Sherwood	220
Sony	228
Soundesign	244
Teac	212, 216, 218
Technics	224, 225, 227
Victor	240, 241, 245
Yamaha	202, 203, 204

AUX

Codes for Personal Video Recorders

Brand	Code
Panasonic Replay	100
Philips Tivo	101
Sony Tivo	102

AUX

Codes for Cassette Deck

Brand	Code
Aiwa	223, 224, 225
Denon	231
Fisher	203
Jensen	214
JVC	229, 230
Kenwood	200, 207
Marantz	202
Nakamichi	205
Onkyo	208, 209, 213
Panasonic	216, 218

Brand	Code
Philips	222
Pioneer	204
RCA	226, 227, 228
Sansui	205, 210
Sharp	231
Sony	219, 220
Teac	210, 211, 215
Technics	216, 218
Yamaha	201, 202

Operating peripheral equipment using the remote control

RCVR

Codes for Receivers

Brand	Code
Admiral	120
Aiwa	125, 126
Denon	134, 135, 136
Fisher	104
Garrard	113
Harman Kardon	115, 123
Jensen	129
JVC	132, 133
Kenwood	100, 108
Magnavox	127
Marantz	124
McIntosh	116
Nakamichi	106
Onkyo	109, 114

Brand	Code
Optimus	103, 127, 130, 131
Panasonic	118, 119, 121
Philips	123
Pioneer	105, 107
Quasar	118, 119, 121
RCA	103, 105, 127, 130, 131
Sansui	103, 111, 139
Sharp	134, 137
Sony	122
Soundesign	138
Teac	111, 112, 113
Technics	118, 119, 121
Victor	132, 133
Yamaha	101, 102

CBL

Codes for Cable Box

Brand	Code
ABC	124
Archer	125, 132
Cableview	105, 132
Citizen	105, 122
Curtis	112, 113
Diamond	124, 125, 132
Eagle	129
Eastern	134
GC Brand	105, 132
Gemini	122
General Instrument/Jerrold	111, 119, 120, 121, 122, 123, 124, 125, 126, 127
Hamlin	112, 118, 140, 141, 142, 145
Hitachi	103, 124
Macom	103, 104, 105
Magnavox	133
Memorex	130
Movietime	105, 132
Oak	102, 137, 139
Panasonic	109, 110, 114
Philips	106, 107, 128, 129, 130
Pioneer	101, 116
Pulsar	105, 132

Brand	Code
Puser	132
RCA	115
Realistic	132
Regal	112, 118, 140, 141, 142, 145
Regency	134
Rembrandt	105, 132, 137
Samsung	105
Scientific Atlanta	111, 112, 113
Slmark	101, 105
Sprucer	105, 110
Stargate	105, 132
Tel eview	101, 105
Texscan	144
Tocom	135
Toshiba	104
Unika	125, 132
Universal	122, 132
Videoway	106
Viewstar	129, 130
Zenith	100, 117
Zenith /Drae Satellite	100

DBS

Codes for DBS

















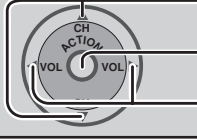



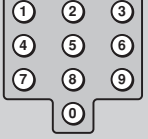

Brand	Code
Dish Network	105, 115, 116
Echo Star (EchoStar)	105
Express VU	105, 115
G.E.	106
G.I. (General Instrument)	108
Gradiente	114
Hitachi	103, 111, 112
HNS (Hughes)	103

Brand	Code
Magnavox	101, 102
Panasonic	104
Philips	101, 102
Primestar	108
Proscan	106, 109, 110, 113
RCA	106, 109, 110, 113
Sony	107
Star Choice	103, 108
Toshiba	100
Uniden	101, 102

Operating peripheral equipment using the remote control

Mode Operational Key Chart

This chart defines which keys are operational after programming (if needed), while in the selected remote control mode TV, DTV, CABLE, DBS, VCR, DVD ...etc.



















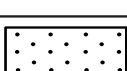

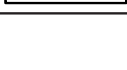
KEY NAME	DTV MODE	CABLE MODE	DBS MODE	VCR MODE
	DTV POWER	CABLE POWER	DBS POWER	VCR POWER
	DTV SAP	–	–	–
	TV MUTE	CABLE MUTE	TV MUTE	TV MUTE
	DTV ASPECT	–	DBS ASPECT	–
	TV INPUT SW	TV INPUT SW	TV INPUT SW	TV INPUT SW
	REMOTE BUTTONS	REMOTE BUTTONS	REMOTE BUTTONS	REMOTE BUTTONS
	–	CABLE CH UP/DOWN	DBS NAVIGATION UP/DOWN	VCR CH UP/DOWN
	DTV ACTION	CABLE ENTER	DBS ACTION	TV ACTION
	DTV NAVIGATION LEFT/RIGHT	CABLE VOL – / +	DBS NAVIGATION LEFT/RIGHT	TV VOLUME – / +
	STB MENU	–	STB MENU	–
	STB PROGRAM INFO.	TV DISPLAY	STB PROG.INFO	ONSCREEN VCR DISPLAY
	DTV EXIT (EPG)ELECTRONIC PROGRAM GUIDE	–	STB EXIT	–
	STB PAGE DOWN/UP	–	STB PAGE DOWN/UP	–
	STB GUIDE (EPG)ELECTRONIC PROGRAM GUIDE	–	DBS PROGRAM GUIDE	–
	Select STB Channel	Select CABLE Channel	Select DBS Channel	Select VCR Channel
	PREVIOUS DTV CH	CABLE PREVIOUS	STB PREVIOUS	–
	DTV PROGRAM/DASH	–	STB PROGRAM/DASH	–
	–	–	–	VCR REW/FF
	–	–	–	VCR PLAY
	–	–	–	VCR PAUSE
	–	–	–	VCR STOP
	–	VCR RECORD	STB RECORD	VCR RECORD
	–	–	STB/DTV/SAT SW	TV/VCR SW
	–	CABLE CH DOWN/UP	STB CH DOWN/UP	VCR CH DOWN/UP
	–	–	STB SEARCH	–

Operating peripheral equipment using the remote control

KEY NAME	DVD MODE		AUX MODE			RCVR MODE
	(DVD)	(CD)	(VCR2)	(PVR)	(TAPE)	
	DVD POWER	CD POWER	VCR POWER	PVR POWER	TAPE POWER	RCVR POWER
	—	—	—	—	—	—
	TV MUTE	RCVR MUTE	TV MUTE	TV MUTE	RCVR MUTE	RCVR MUTE
	—	—	—	—	—	—
	TV INPUT SW	TV INPUT SW	TV INPUT SW	TV INPUT SW	TV INPUT SW	RCVR INPUT SW
	REMOTE BUTTONS	REMOTE BUTTONS	REMOTE BUTTONS	REMOTE BUTTONS	REMOTE BUTTONS	REMOTE BUTTONS
	NAVIGATION UP/DOWN	NEXT/PREVIOUS UP/DOWN	VCR CH UP/DOWN	NAVIGATION UP/DOWN	—	TUNER -/+
	DVD SELECT	—	TV ACTION	—	—	—
	NAVIGATION LEFT/RIGHT	TV/RCVR VOLUME -/+	TV VOLUME -/+	NAVIGATION LEFT/RIGHT	RCVR VOLUME -/+	RCVR VOLUME -/+
	DVD MENU	—	—	RVR MENU	—	—
	DVD DISPLAY	TIME FORMAT	ONSCREEN VCR DISPLAY	—	—	—
	—	—	—	EXIT PVR MENU	—	—
	DVD SKIP -/+	CD SKIP -/+	—	—	—	—
	DVD TITLE	—	—	—	—	—
	Select DVD Number	Select CD Track Number	Select VCR Channel	Select PVR Channel	—	1.... AV1 2.... AV2 3.... AV3 4.... AV4 5.... CD 6.... TUNER 7.... PHONO 8.... TAPE 9.... AUX
	—	—	—	PREVIOUS PVR CH/RELAY ZONES	DECK A/B	—
	—	—	—	RVR RETURN TO LIVE	—	—
	SKIP SEARCH REW/FF	SEARCH REW/FF	VCR REW/FF	—	TAPE REW/FF	SURROUND -/+
	DVD PLAY	CD PLAY	VCR PLAY	PVR PLAY	TAPE PLAY	—
	DVD PAUSE	CD PAUSE	VCR PAUSE	PVR PAUSE	TAPE PAUSE	—
	DVD STOP	CD STOP	VCR STOP	—	TAPE STOP	—
	—	—	VCR RECORD	PVR RECORD	TAPE RECORD	—
	—	—	TV/VCR SW	PVR CH DOWN/UP	—	—
	DVD SLOW -/+	RANDOM/REPLAY	VCR CH DOWN/UP	—	—	CENTER -/+
	DVD OPEN/CLOSE	CD OPEN/CLOSE	—	PVR QUICK SKIP	TAPE OPEN/CLOSE	—

Troubleshooting Chart

Before calling for service, determine the symptoms and follow suggested solutions.

Symptoms		Solutions
VIDEO	AUDIO	
 Snowy Video	 Noisy Audio	Adjust Antenna Location and Connection
 Multiple Image	 Noisy Audio	Adjust Antenna Location and Connection Check Antenna Lead-in Wire
 Interference	 Noisy Audio	Move Television away from Electrical Appliances, Lights, Vehicles and Medical Equipment
 Normal Video	 No Audio	Increase Volume Check Mute Check Television SPEAKERS on/off Change Channel
 No Video with Snow	 Noisy Audio	Set TV or Cable Mode Properly Check Antenna Cables
 No Video / No PIP	 No Audio	Check Power Cord is Plugged into Active Outlet Adjust Brightness and Audio Controls Change Channel Check Cable Connections Program the Remote Control Again Check Second Video Source Operation
 No Color	 Normal Audio	Adjust Color Settings Change Channel
 Normal Video	 Wrong Audio	Check Audio Is Set To Stereo or Mono, Not SAP
 Black Box on Screen	 Normal Audio	Change CC (Closed Captioning) from Text Mode
 Normal Video	 Normal Audio	Replace Remote Control Batteries
Intermittent Remote Control Operation		

Plasma Display panel

Symptoms	Check
Some parts of the screen do not light up.	The plasma display panel is manufactured using an extremely high level of precision technology, however, sometimes some parts of the screen may be missing picture elements or have luminous spots. This is not a malfunction.
 <p>After-images appear</p>	<p>Do not allow a still picture to be displayed for an extended period, as this can cause a permanent after-image to remain on the Plasma Display. Examples of still pictures include logos, video games, computer images, teletext and images displayed in 4:3 mode.</p> <p>Note: The permanent after-image on the Plasma Display resulting from fixed image use is not an operating defect and as such is not covered by the Warranty. This product is not designed to display fixed images for extended periods of time.</p>

VIDEO/COMPONENT/RGB/PC/DVI input signals

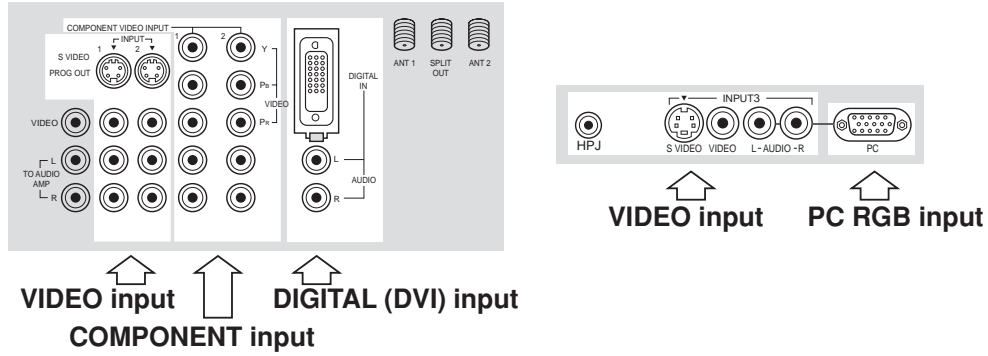

VIDEO input

	signal name	horizontal frequency(kHz)	vertical frequency(Hz)
1	NTSC	15.73	59.94

Applicable input signals (* mark)

	signal name	horizontal frequency(kHz)	vertical frequency(Hz)	COMPONENT	PC	DVI
1	525 (480) /60i	15.73	59.94	*	*	
2	525 (480) /60p	31.47	59.94	*	*	*
3	1,125 (1,080) /60i	33.75	59.94	*	*	*
4	640 × 400 @70	31.47	70.00		*	
5	640 × 480 @60	31.47	59.94		*	
6	Macintosh13" (640 × 480)	35.00	66.67		*	
7	640 × 480 @75	37.50	75.00		*	
8	852 × 480 @60	31.50	60.00		*	
9	800 × 600 @60	37.88	60.32		*	
10	800 × 600 @75	46.88	75.00		*	
11	800 × 600 @85	53.67	85.06		*	
12	Macintosh16" (832 × 624)	49.73	74.55		*	
13	1,024 × 768 @60	48.36	60.00		*	
14	1,024 × 768 @70	56.48	70.07		*	
15	1,024 × 768 @75	60.02	75.03		*	
16	1,024 × 768 @85	68.68	85.00		*	
17	Macintosh21" (1,152 × 870)	68.68	75.06		*	
18	1,280 × 1,024 @60	63.98	60.02		*	
19	1,280 × 1,024 @75	79.98	75.03		*	
20	1,280 × 1,024 @85	91.15	85.02		*	
21	1,600 × 1,200 @60	75.00	60.00		*	

Note: Signals without above specification may not be displayed properly.

Specifications

		TH-37PA20	TH-42PA20 / TH-42PA25
Power Source		AC 120 V, 50/60 Hz	AC 120 V, 50/60 Hz
Power Consumption		Maximum : 355 W Stand-by condition : 0.8 W	Maximum : 425 W Stand-by condition : 0.8 W
Plasma Display panel		Drive method : AC type 37-inch, 16 : 9 aspect ratio	Drive method : AC type 42-inch, 16 : 9 aspect ratio
Screen Size		32.20 " (818 mm) (W) × 18.15 " (461 mm) (H) × 36.97 " (939mm) (diagonal)	36.22 " (920 mm) (W) × 20.39 " (518 mm) (H) × 41.57 " (1056 mm) (diagonal)
Dimensions (W × H × D)		42.13 " (1070mm) × 23.46 " (596 mm) × 3.90 " (99 mm)	46.06 " (1170mm) × 29.91 " (658 mm) × 3.90 " (99 mm)
Mass (Weight)		65.0 lb. (29.5 kg) Net	77.2 lb. (35.0 kg) Net
Channel Capability-181		VHF-12 : UHF-56 : Cable-125	
Sound	Speaker	Woofer φ 1.57" (40 mm) × 8 , Tweeter φ 1.38" (35 mm) × 2	
	Audio Output	16 W [8 W + 8 W] (10 % THD)	
	Headphone	M3 (3.5 mm) Jack × 1	
FEATURES		Two screen display fuctions BBE VIVA CLOSED CAPTION	3D Y/C FILTER LINEAR PIP V-Chip
Accessories Supplied		Remote control Transmitter : EUR7603ZC0 AA Battery × 2 AC Cord Pedestal	Ferrite cores (small × 5, large × 5) F type Antenna Adaptor (3C-2V × 2, 5C-2V × 2) Fixing band
Operating Conditions		Temperature : 34 °F - 104 °F (0 ° - 40 °C) Humidity : 20 % - 80 % (non-condensing)	
Connection Terminals		RGB input D-SUB 15pin AV INPUT 1- 3 VIDEO (Phono Jack Type) S-VIDEO (Mini DIN 4-pin) AUDIO L-R (Phono Jack Type × 2) AV PROG. OUT VIDEO (Phono Jack Type) AUDIO L-R (Phono Jack Type × 2) TO AUDIO AMP AUDIO L-R (Phono Jack Type × 2) COMPONENT VIDEO INPUT1-2 Y P _B / P _R AUDIO L-R (Phono Jack Type × 2) DIGITAL IN INPUT DVI 1.0 AUDIO L-R (Phono Jack Type × 2)	R,G,B / 0.7 Vp-p (75 Ω) HD, VD / 1.0 - 5.0 Vp-p (high impedance) 1.0 Vp-p (75 Ω) Y : 1.0 Vp-p (75 Ω), C : 0.286 Vp-p (75 Ω) 0.5 Vrms 1.0 Vp-p (75 Ω) 0.5 Vrms 0.5 Vrms 1.0 Vp-p (including synchronization) ± 0.35 Vp-p 0.5 Vrms 24 pin 0.5 Vrms

Note:

Design and Specifications are subject to change without notice. Mass and Dimensions shown are approximate.

Customer's Record

The model number and serial number of this product can be found on its back cover. You should note this serial number in the space provided below and retain this book, plus your purchase receipt, as a permanent record of your purchase to aid in identification in the event of theft or loss, and for Warranty Service purposes.

Model Number _____

Serial Number _____

Panasonic Consumer Electronics Company, Division of Matsushita Electric Corporation of America
One Panasonic Way Secaucus,
New Jersey 07094

Panasonic Sales Company, Division of Matsushita Electric of Puerto Rico Inc. ("PSC")
Ave. 65 de Infanteria, Km 9.5
San Gabriel Industrial Park,
Carolina, Puerto Rico 00985

Panasonic Canada Inc.
5770 Ambler Drive
Mississauga, Ontario
L4W 2T3