

Panasonic®

Operating Instructions Manual de instrucciones High Definition Plasma Display Alta definición Pantalla de plasma

Model No. **TH-58PF12UK**
No. de Modelo **TH-65PF12UK**



Contents

Important Safety Instructions	3	Selecting the input signal	14
FCC STATEMENT	4	Basic Controls	15
Safety Precautions	5	On-Screen Menu Displays	17
Maintenance	6	Specifications	19
Accessories	7	Panasonic Professional Flat Panel Display Limited Warranty ..	20
Connections	8	LIMITED WARRANTY STATEMENT	21
Power ON / OFF	12	Customer Service	22

The illustration shown is an image.
Before connecting, operating or adjusting this product, please read these instructions completely.
Please keep this manual for future reference.

La ilustración mostrada es una imagen.
Antes de conectar, utilizar o ajustar este producto, lea completamente este manual de instrucciones;
y guárdelo para consultarlo en el futuro en caso de ser necesario.

For more detailed instructions, refer to the Operating Instructions on the CD-ROM.
To view the Operating Instructions on the CD-ROM, you need a computer equipped with a CD-ROM drive, and Adobe® Reader® (Version 7.0 or later is recommended) installed on your computer.
Depending on the operating system or settings on your computer, the Operating Instructions may not start automatically.
In this case, open the PDF file under \MANUAL\PDF manually to view the instructions.

Para obtener instrucciones más detalladas, consulte las instrucciones de manejo contenidas en el CD-ROM.
Para ver las instrucciones de manejo contenidas en el CD-ROM, se necesita un ordenador equipado con una unidad de CD-ROM, y que tenga instalado Adobe® Reader® (se recomienda la versión 7.0 o posterior).
Dependiendo del sistema operativo o de las configuraciones del ordenador, las instrucciones de manejo pueden no iniciarse automáticamente.
En tal caso, abra manualmente el archivo PDF en \MANUAL\PDF para visualizar las instrucciones.

English

Español

HDMI™
HIGH-DEFINITION MULTIMEDIA INTERFACE



TQB2AA0562

	CAUTION RISK OF ELECTRIC SHOCK DO NOT OPEN	
WARNING: To reduce the risk of electric shock, do not remove cover or back. No user-serviceable parts inside. Refer servicing to qualified service personnel.		



The lightning flash with arrow-head within a triangle is intended to tell the user that parts inside the product are a risk of electric shock to persons.



The exclamation point within a triangle is intended to tell the user that important operating and servicing instructions are in the papers with the appliance.

WARNING : To prevent damage which may result in fire or shock hazard, do not expose this apparatus to rain or moisture.
Do not place containers with water (flower vase, cups, cosmetics, etc.) above the set. (including on shelves above, etc.)

WARNING : 1) To prevent electric shock, do not remove cover. No user serviceable parts inside. Refer servicing to qualified service personnel.
2) Do not remove the grounding pin on the power plug. This apparatus is equipped with a three pin grounding-type power plug. This plug will only fit a grounding-type power outlet. This is a safety feature. If you are unable to insert the plug into the outlet, contact an electrician.
Do not defeat the purpose of the grounding plug.

Important Safety Instructions

- 1) Read these instructions.
- 2) Keep these instructions.
- 3) Heed all warnings.
- 4) Follow all instructions.
- 5) Do not use this apparatus near water.
- 6) Clean only with dry cloth.
- 7) Do not block any ventilation openings. Install in accordance with the manufacturer's instructions.
- 8) Do not install near any heat sources such as radiators, heat registers, stoves, or other apparatus (including amplifiers) that produce heat.
- 9) Do not defeat the safety purpose of the polarized or grounding-type plug. A polarized plug has two blades with one wider than the other. A grounding type plug has two blades and a third grounding prong. The wide blade or the third prong are provided for your safety. If the provided plug does not fit into your outlet, consult an electrician for replacement of the obsolete outlet.
- 10) Protect the power cord from being walked on or pinched particularly at plugs, convenience receptacles, and the point where they exit from the apparatus.
- 11) Only use attachments / accessories specified by the manufacturer.
- 12) Use only with the cart, stand, tripod, bracket, or table specified by the manufacturer, or sold with the apparatus. When a cart is used, use caution when moving the cart / apparatus combination to avoid injury from tip-over.
- 13) Unplug this apparatus during lightning storms or when unused for long periods of time.
- 14) Refer all servicing to qualified service personnel. Servicing is required when the apparatus has been damaged in any way, such as power-supply cord or plug is damaged, liquid has been spilled or objects have fallen into the apparatus, the apparatus has been exposed to rain or moisture, does not operate normally, or has been dropped.
- 15) To prevent electric shock, ensure the grounding pin on the AC cord power plug is securely connected.



FCC STATEMENT

This equipment has been tested and found to comply with the limits for a Class B digital device, pursuant to Part 15 of the FCC Rules. These limits are designed to provide reasonable protection against harmful interference in a residential installation. This equipment generates, uses and can radiate radio frequency energy and, if not installed and used in accordance with the instructions, may cause harmful interference to radio communications. However, there is no guarantee that interference will not occur in a particular installation. If this equipment does cause harmful interference to radio or television reception, which can be determined by turning the equipment off and on, the user is encouraged to try to correct the interference by one or more of the following measures:

- Reorient or relocate the receiving antenna.
- Increase the separation between the equipment and receiver.
- Connect the equipment into an outlet on a circuit different from that to which the receiver is connected.
- Consult the dealer or an experienced technician for help.

This device complies with Part 15 of the FCC Rules. Operation is subject to the following two conditions: (1) This device may not cause harmful interference, and (2) this device must accept any interference received, including interference that may cause undesired operation.

FCC CAUTION:

To assure continued compliance, follow the attached installation instructions and use only shielded interface cables when connecting to computer or peripheral devices. Any changes or modifications not expressly approved by Panasonic Corp. of North America could void the user's authority to operate this device.

FCC Declaration of Conformity

Model No. TH-58PF12UK, TH-65PF12UK

Responsible Party: Panasonic Corporation of North America
One Panasonic Way 1F-10, Secaucus, NJ 07094
Contact Source: Panasonic Professional Display Company
Panasonic Plasma Concierge 1-800-973-4390

CANADIAN NOTICE:

This Class B digital apparatus complies with Canadian ICES-003.

Note:

Do not allow a still picture to be displayed for an extended period, as this can cause a permanent image retention to remain on the Plasma Display.

Examples of still pictures include logos, video games, computer images, teletext and images displayed in 4:3 mode.

Trademark Credits

- VGA is a trademark of International Business Machines Corporation.
- Macintosh is a registered trademark of Apple Inc. USA.
- SVGA, XGA, SXGA and UXGA are registered trademarks of the Video Electronics Standard Association.
Even if no special notation has been made of company or product trademarks, these trademarks have been fully respected.
- HDMI, the HDMI logo and High-Definition Multimedia Interface are trademarks or registered trademarks of HDMI Licensing LLC.

Safety Precautions

CAUTION

This Plasma Display is for use only with the following optional accessories. Use with any other type of optional accessories may cause instability which could result in the possibility of injury.

(All of the following accessories are manufactured by Panasonic Corporation.)

- Speakers TY-SP58P10WK (for TH-58PF12UK),
TY-SP65P11WK (for TH-65PF12UK)
- Pedestal TY-ST58-K (for TH-58PF12UK), TY-ST65P11-K (for TH-65PF12UK)
- Mobile stand TY-ST58PF10 (for TH-58PF12UK)
- Wall-hanging bracket (vertical) TY-WK42PV7 (for TH-58PF12UK), TY-WK65PV7 (for TH-65PF12UK)
- Wall-hanging bracket (angled) TY-WK42PR7 (for TH-58PF12UK), TY-WK65PR8 (for TH-65PF12UK)
- BNC Component Video Terminal Board TY-42TM6A
- BNC Composite Video Terminal Board TY-42TM6B
- BNC Dual Video Terminal Board TY-FB9BD
- RCA Component Video Terminal Board TY-42TM6Z
- RCA Composite Video Terminal Board TY-42TM6V
- RGB Active Through Terminal Board TY-42TM6G
- PC Input Terminal Board TY-42TM6P
- Composite / Component Video Terminal Board... TY-42TM6Y
- BNC SDI Terminal Board TY-FB7SD
- HD-SDI Terminal Board TY-FB9HD
- HD-SDI Terminal Board with audio TY-FB10HD
- Dual Link HD-SDI Terminal Board TY-FB11DHD
- HDMI Terminal Board TY-FB8HM
- Dual HDMI Terminal Board TY-FB10HMD
- DVI-D Terminal Board TY-FB11DD
- Ir Through Terminal Board TY-FB9RT
- Wireless Presentation Board TY-FB10WPU
- AV Terminal Box TY-TB10AV
- LAN Control Board TY-FB12LC
- Anti Glare Filter TY-AR58P10W (for TH-58PF12UK), TY-AR65P9W (for TH-65PF12UK)
- Touch Panel TY-TP58P10S (for TH-58PF12UK), TY-TP65P10S (for TH-65PF12UK)

Always be sure to ask a qualified technician to carry out set-up.

Small parts can present choking hazard if accidentally swallowed. Keep small parts away from young children. Discard unneeded small parts and other objects, including packaging materials and plastic bags/sheets to prevent them from being played with by young children, creating the potential risk of suffocation.

■ When using the Plasma Display

Do not bring your hands, face or objects close to the ventilation holes of the Plasma Display.

- Top of the Plasma Display is usually very hot due to the high temperature of exhaust air being released through the ventilation holes. Burns or personal injuries can happen if any body parts are brought too close. Placing any object near the top of the display could also result in heat damages to the object as well as to the Display if its ventilation holes are blocked.

Be sure to disconnect all cables before moving the Plasma Display.

- Moving the Display with its cables attached might damage the cables which, in turn, can cause fire or electric shock.

Disconnect the power plug from the wall outlet as a safety precaution before carrying out any cleaning.

- Electric shocks can result if this is not done.

Clean the power cable regularly to prevent it from becoming dusty.

- Built-up dust on the power cord plug can increase humidity which might damage the insulation and cause fire. Unplug the cord from the wall outlet and clean it with a dry cloth.

This Plasma Display radiates infrared rays, therefore it may affect other infrared communication equipment. Install your infrared sensor in a place away from direct or reflected light from your Plasma Display.

Note:

Do not allow a still picture to be displayed for an extended period, as this can cause a permanent image retention to remain on the Plasma Display.

Examples of still pictures include logos, video games, computer images, teletext and images displayed in 4:3 mode.

WARNING

■ Setup

Do not place the Plasma Display on sloped or unstable surfaces.

- The Plasma Display may fall off or tip over.

Do not place any objects on top of the Plasma Display.

- If water spills onto the Plasma Display or foreign objects get inside it, a short-circuit may occur which could result in fire or electric shock. If any foreign objects get inside the Plasma Display, please consult an Authorized Service Center.

Do not cover the ventilation holes.

- Doing so may cause the Plasma Display to overheat, which can cause fire or damage to the Plasma Display.

Transport only in upright position!

- Transporting the unit with its display panel facing upright or downward may cause damage to the internal circuitry.

If using the pedestal (optional accessory), leave a space of 3 15/16" (10 cm) or more at the top, left and right, and 2 3/4" (7 cm) or more at the rear, and also keep the space between the bottom of the display and the floor surface. If using some other setting-up method, follow the manual of it. (If there is no specific indication of installation dimension in the installation manual, leave a space of 3 15/16" (10 cm) or more at the top, bottom, left and right, and 2 3/4" (7 cm) or more at the rear.)

An apparatus with CLASS I construction shall be connected to a mains socket outlet with a protective earthing connection.

■ AC Power Supply Cord

The Plasma Display is designed to operate on 110 - 127 V AC, 50/60 Hz.

Do not use any power supply cord other than that provided with this unit.

- Doing so may cause fire or electric shocks.

Securely insert the power cord plug as far as it will go.

- If the plug is not fully inserted, heat may be generated which could cause fire. If the plug is damaged or the wall socket plate is loose, they should not be used.

Do not handle the power cord plug with wet hands.

- Doing so may cause electric shocks.

Do not do anything that might damage the power cable. When disconnecting the power cable, hold the plug, not the cable.

- Do not make any modifications, place heavy objects on, place near hot objects, heat, bend, twist or forcefully pull the power cable. Doing so may cause damage to the power cable which can cause fire or electric shock. If damage to the cable is suspected, have it repaired at an Authorized Service Center.

If the Plasma Display will not be used for a long period of time, unplug the power cord from the wall outlet.

■ If problems occur during use

If a problem occurs (such as no picture or no sound), or if smoke or an abnormal odor is detected from the Plasma Display, unplug the power cord immediately.

- Continuous use of the Display under these conditions might cause fire or permanent damage to the unit. Have the Display evaluated at an Authorized Service Center. Services to the Display by any unauthorized personnel are strongly discouraged due to its high voltage dangerous nature.

If water or foreign objects get inside the Plasma Display, if the Plasma Display is dropped, or if the cabinet becomes damaged, disconnect the power cord plug immediately.

- A short may occur, which could cause fire. Contact an Authorized Service Center for any repairs that need to be made.

Maintenance

The front of the display panel has been specially treated. Wipe the panel surface gently using only a cleaning cloth or a soft, lint-free cloth.

- If the surface is particularly dirty, wipe with a soft, lint-free cloth which has been soaked in pure water or water in which neutral detergent has been diluted 100 times, and then wipe it evenly with a dry cloth of the same type until the surface is dry.
- Do not scratch or hit the surface of the panel with fingernails or other hard objects, otherwise the surface may become damaged. Furthermore, avoid contact with volatile substances such as insect sprays, solvents and thinner, otherwise the quality of the surface may be adversely affected.

If the cabinet becomes dirty, wipe it with a soft, dry cloth.

- If the cabinet is particularly dirty, soak the cloth in water to which a small amount of neutral detergent has been added and then wring the cloth dry. Use this cloth to wipe the cabinet, and then wipe it dry with a dry cloth.
- Do not allow any detergent to come into direct contact with the surface of the Plasma Display. If water droplets get inside the unit, operating problems may result.
- Avoid contact with volatile substances such as insect sprays, solvents and thinner, otherwise the quality of the cabinet surface may be adversely affected or the coating may peel off. Furthermore, do not leave it for long periods in contact with articles made from rubber or PVC.

Accessories

Accessories Supplied

Check that you have the Accessories and items shown



Operating Instruction book

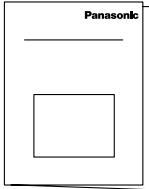

CD-ROM (Operating instructions)

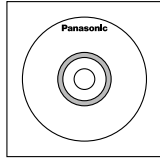

Remote Control Transmitter N2QAYB000432

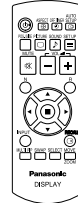

Batteries for the Remote Control Transmitter (AA Size x 2)

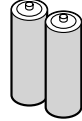

Fixing band x 1

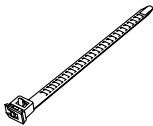

AC cord

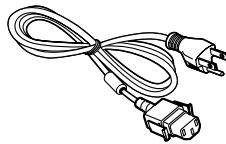

Remote Control Batteries

Requires two AA batteries.

1. Pull and hold the hook, then open the battery cover.
2. Insert batteries - note correct polarity (+ and -).
3. Replace the cover.

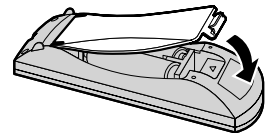
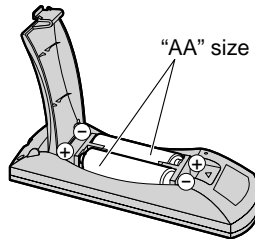
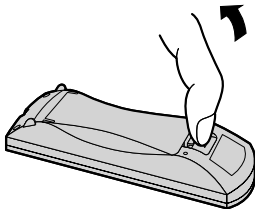

Helpful Hint:

For frequent remote control users, replace old batteries with Alkaline batteries for longer life.

⚠ Precaution on battery use

Incorrect installation can cause battery leakage and corrosion that will damage the remote control transmitter. Disposal of batteries should be in an environment-friendly manner.

Observe the following precautions:

1. Batteries should always be replaced as a pair. Always use new batteries when replacing the old set.
2. Do not combine a used battery with a new one.
3. Do not mix battery types (example: "Zinc Carbon" with "Alkaline").
4. Do not attempt to charge, short-circuit, disassemble, heat or burn used batteries.
5. Battery replacement is necessary when the remote control acts sporadically or stops operating the Plasma Display.
6. Do not burn or breakup batteries.

Batteries must not be exposed to excessive heat such as sunshine, fire or the like.

Connections

When connecting the speakers, be sure to use only the optional accessory speakers. Refer to the speaker's Installation Manual for details on speaker installation.

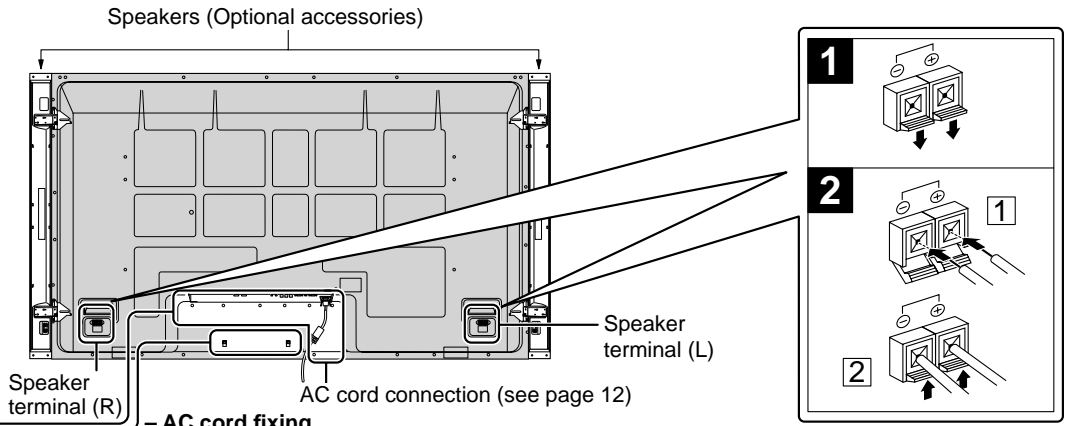

- AC cord fixing

1 Plug the AC cord into the display unit. Plug the AC cord until it clicks.

2 Fix the AC cord with the clamber which is attached to the unit. For TH-58PF12UK: Clambers are not installed to this unit. Ensure there is sufficient slack in the AC cord and firmly bind with the supplied cable fixing band, etc.

Note: Make sure that the AC cord is locked on both the left and right sides.

Close

Push until the hook clicks.

Open

1. Keep the knob pressed.

2. Pull off.

Unplug the AC cord

Unplug the AC cord pressing the two knobs.

Note: When disconnecting the AC cord, be absolutely sure to disconnect the AC cord plug at the socket outlet first.

- Cable fixing band

Secure any excess cables with band as required.

Note: One fixing band is supplied with this unit. In case of securing cables at two positions, please purchase it separately.

Pass the attached cable fixing band through the clip as shown in the figure.

To secure cables connected to Terminals, wrap the cable fixing band around them then pass the pointed end through the locking block, as shown in the figure. **While ensuring there is sufficient slack in cables to minimize stress (especially in the power cord), firmly bind all cables with the supplied fixing band.**

1

2

To tighten: Pull

To loosen: Push the catch

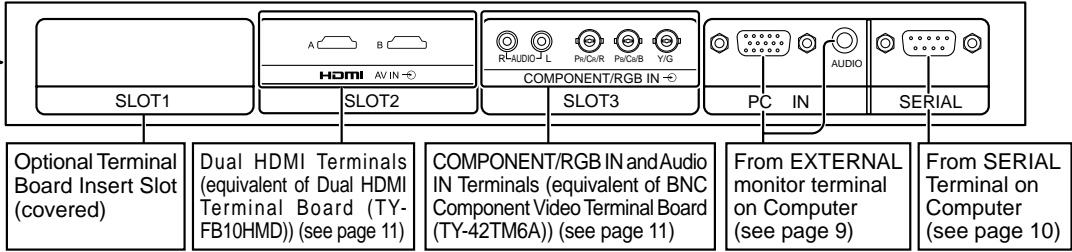

Note: At factory shipment, Terminal boards are installed in SLOT 2 and SLOT 3.

PC Input Terminals connection

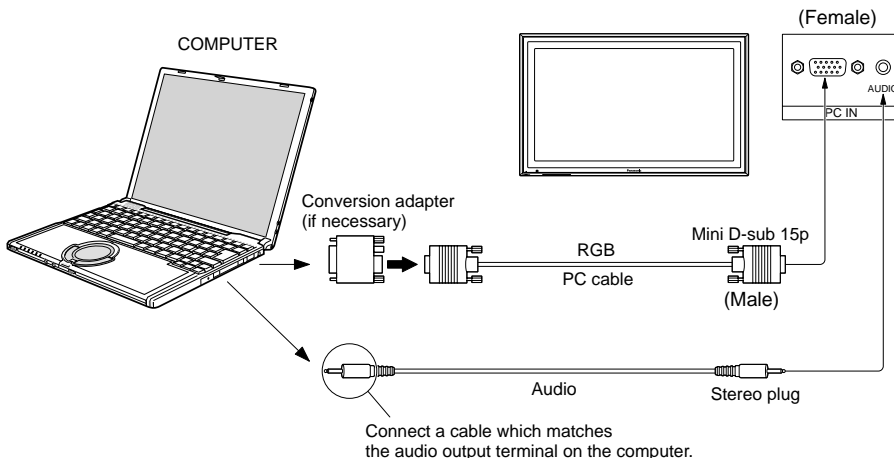

Notes:

- With regard to the typical PC input signals that are described in the applicable input signals list, adjustment values such as for the standard picture positions and sizes have already been stored in this unit. You can add up to eight PC input signal types that are not included in the list.
- Computer signals which can be input are those with a horizontal scanning frequency of 15 to 110 kHz and vertical scanning frequency of 48 to 120 Hz. (However, the image will not be displayed properly if the signals exceed 1,200 lines.)
- The display resolution is a maximum of 1,440 × 1,080 dots when the aspect mode is set to “4:3”, and 1,920 × 1,080 dots when the aspect mode is set to “FULL”. If the display resolution exceeds these maximums, it may not be possible to show fine detail with sufficient clarity.
- The PC input terminals are DDC2B-compatible. If the computer being connected is not DDC2B-compatible, you will need to make setting changes to the computer at the time of connection.
- Some PC models cannot be connected to the set.
- There is no need to use an adapter for computers with DOS/V compatible Mini D-sub 15P terminal.
- The computer shown in the illustration is for example purposes only.
- Additional equipment and cables shown are not supplied with this set.
- Do not set the horizontal and vertical scanning frequencies for PC signals which are above or below the specified frequency range.
- Component Input is possible with the pin 1, 2, 3 of the Mini D-sub 15P Connector.
- Change the “COMPONENT/RGB-IN SELECT” setting in the “SET UP” menu to “COMPONENT” (when COMPONENT signal connection) or “RGB” (when RGB signal connection).

Signal Names for Mini D-sub 15P Connector

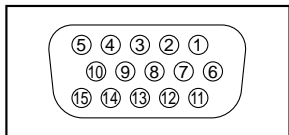

Pin Layout for PC Input Terminal

Pin No.	Signal Name	Pin No.	Signal Name	Pin No.	Signal Name
①	R (P _R /C _R)	⑥	GND (Ground)	⑪	NC (not connected)
②	G (Y)	⑦	GND (Ground)	⑫	SDA
③	B (P _B /C _B)	⑧	GND (Ground)	⑬	HD/SYNC
④	NC (not connected)	⑨	+5 V DC	⑭	VD
⑤	GND (Ground)	⑩	GND (Ground)	⑮	SCL

SERIAL Terminals connection

The SERIAL terminal is used when the Plasma Display is controlled by a computer.

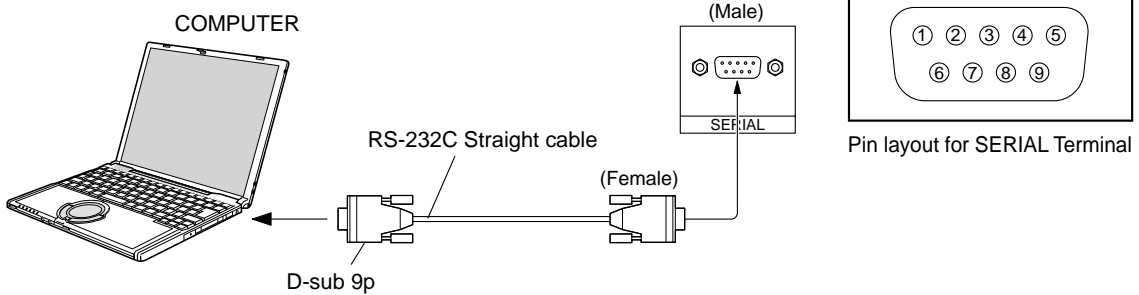

Notes:

- Use the RS-232C straight cable to connect the computer to the Plasma Display.
- The computer shown is for example purposes only.
- Additional equipment and cables shown are not supplied with this set.

The SERIAL terminal conforms to the RS-232C interface specification, so that the Plasma Display can be controlled by a computer which is connected to this terminal. The computer will require software which allows the sending and receiving of control data which satisfies the conditions given below. Use a computer application such as programming language software. Refer to the documentation for the computer application for details.

Signal names for D-sub 9P connector

Pin No.	Details
②	R X D
③	T X D
⑤	GND
④ • ⑥	Non use
⑦ ⑧	← (Shorted in this set)
① • ⑨	

These signal names are those of computer specifications.

Communication parameters

Signal level	RS-232C compliant
Synchronization method	Asynchronous
Baud rate	9600 bps
Parity	None
Character length	8 bits
Stop bit	1 bit
Flow control	-

Basic format for control data

The transmission of control data from the computer starts with a STX signal, followed by the command, the parameters, and lastly an ETX signal in that order. If there are no parameters, then the parameter signal does not need to be sent.

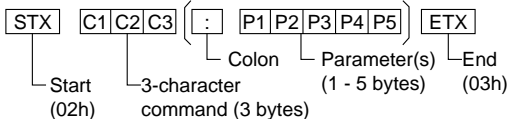

Notes:

- If multiple commands are transmitted, be sure to wait for the response for the first command to come from this unit before sending the next command.
- If an incorrect command is sent by mistake, this unit will send an "ER401" command back to the computer.
- SL1A, SL1B, SL2A and SL2B of Command IMS are available only when a dual input terminal board is attached.

Command

Command	Parameter	Control details
PON	None	Power ON
POF	None	Power OFF
AVL	**	Volume 00 - 63
AMT	0	Audio MUTE OFF
	1	Audio MUTE ON
IMS	None	Input select (toggle)
	SL1	Slot1 input
	SL2	Slot2 input
	SL3	Slot3 input
	PC1	PC input
	SL1A	Slot1 input (INPUT1A)
	SL1B	Slot1 input (INPUT1B)
DAM	None	Screen mode select (toggle)
	ZOOM	ZOOM (For Video/SD/PC signal)
ZOM2	FULL	FULL
	JUST	JUST (For Video/SD signal)
	NORM	4:3 (For Video/SD/PC signal)
	SELF	Panasonic Auto (For Video signal)
	SJST	JUST (For HD signal)
	SNOM	4:3 (For HD signal)
	SFUL	H-FILL (For HD signal)
	ZOOM	ZOOM (For HD signal)

With the power off, this display responds to PON command only.

HDMI connection

This unit has terminal boards equivalent to Dual HDMI Terminal Board (TY-FB10HMD) and BNC Component Video Terminal Board (TY-42TM6A) as standard equipment.

[Pin assignments and signal names]

Pin No.	Signal	Pin No.	Signal
①	T.M.D.S Data2+	⑪	T.M.D.S Clock Shield
②	T.M.D.S Data2 Shield	⑫	T.M.D.S Clock-
③	T.M.D.S Data2-	⑬	CEC
④	T.M.D.S Data1+	⑭	Reserved (N.C. on device)
⑤	T.M.D.S Data1 Shield	⑮	SCL
⑥	T.M.D.S Data1-	⑯	SDA
⑦	T.M.D.S Data0+	⑰	DDC/CEC Ground
⑧	T.M.D.S Data0 Shield	⑱	+5V Power
⑨	T.M.D.S Data0-		Hot Plug Detect
⑩	T.M.D.S Clock+		

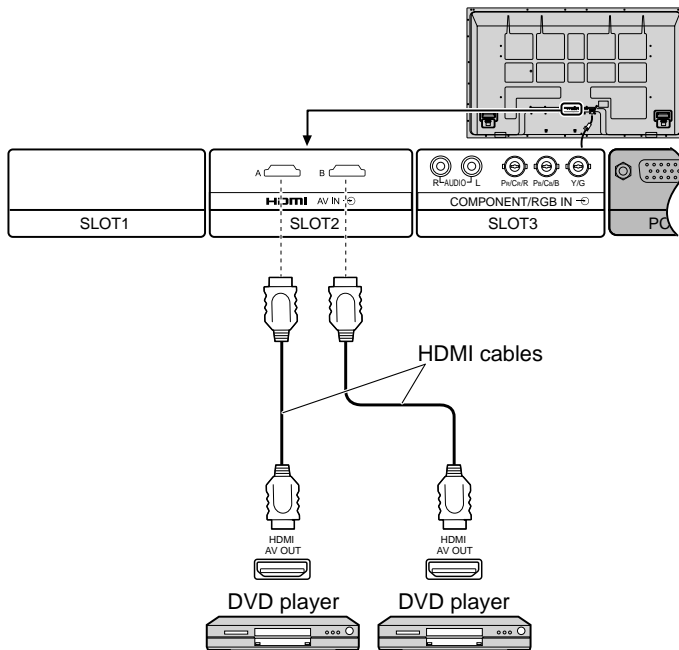
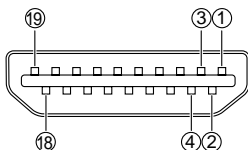

Note:

Additional equipment and HDMI cables shown are not supplied with this set.

COMPONENT / RGB connection

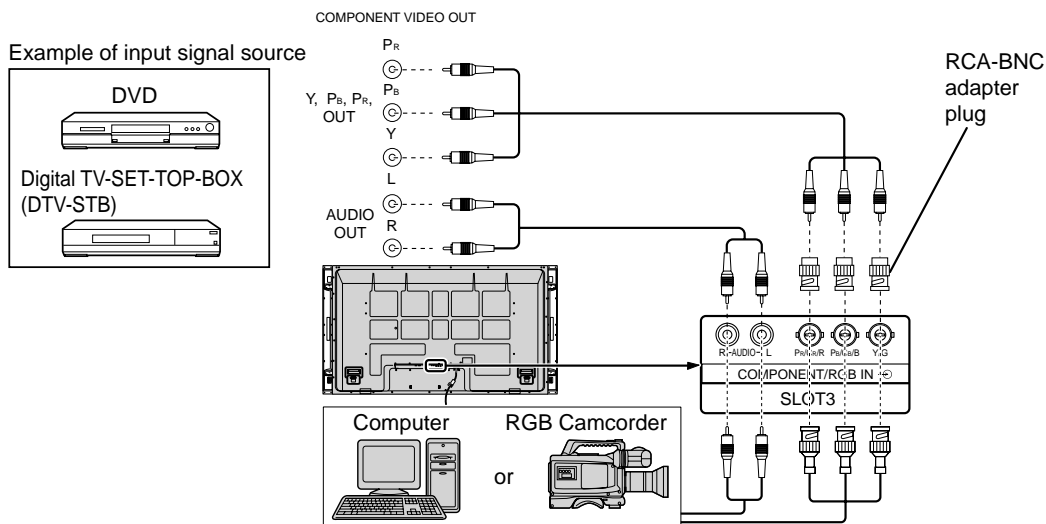

Notes:

- Change the “COMPONENT/RGB-IN SELECT” setting in the “SET UP” menu to “COMPONENT” (when COMPONENT signal connection) or “RGB” (when RGB signal connection).
- Additional equipment, cables and adapter plugs shown are not supplied with this set.
- SYNC ON G signal is needed.

Power ON / OFF

Connecting the AC cord plug to the Plasma Display.

Fix the AC cord plug securely to the Plasma Display with the clamer. (see page 8)

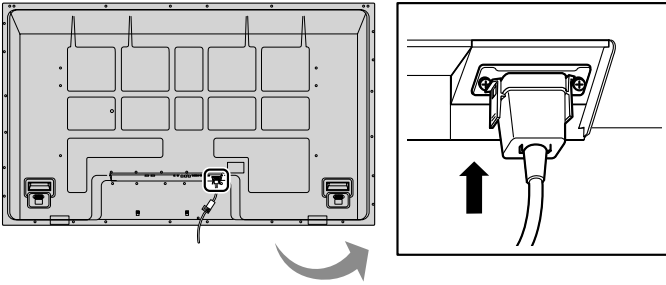

Connecting the plug to the Wall Outlet.

Note:

When disconnecting the AC cord, be absolutely sure to disconnect the AC cord plug at the socket outlet first.

Press the Power switch on the Plasma Display to turn the set on: Power-On.

Power Indicator: Green

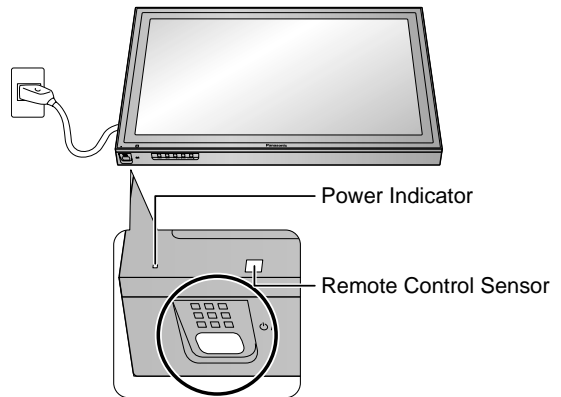

Press the  button on the remote control to turn the Plasma Display off.

Power Indicator: Red (standby)

Press the  button on the remote control to turn the Plasma Display on.

Power Indicator: Green

Turn the power to the Plasma Display off by pressing the /I switch on the unit, when the Plasma Display is on or in standby mode.

Note:

During operation of the power management function, the power indicator turns orange in the power off state.

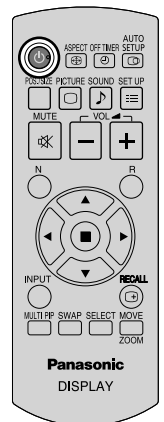

When first switching on the unit

Following screen will be displayed when the unit is turned on for the first time. Select the items with the remote control. Unit buttons are invalid.

OSD LANGUAGE

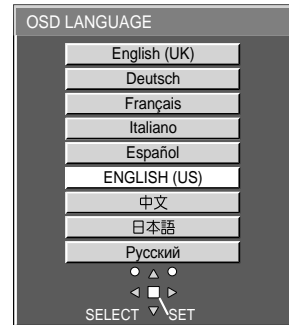
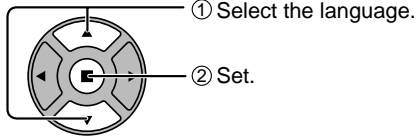

PRESENT TIME SETUP

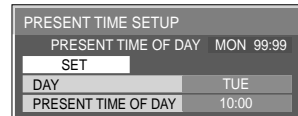
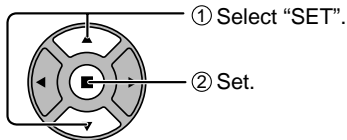
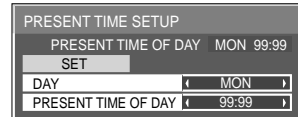
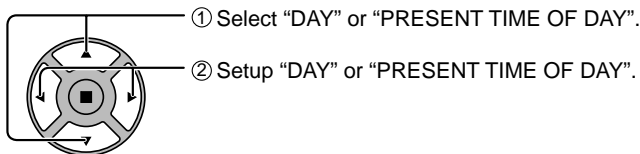

DISPLAY ORIENTATION

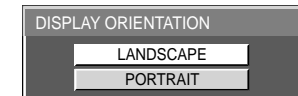
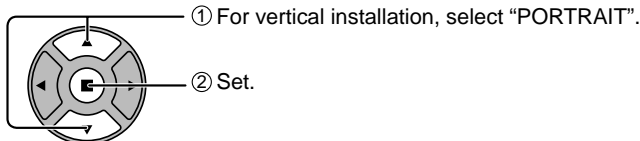

Notes:

- Once the items are set, the screens won't be displayed when switching on the unit next time.
- After the setting, the items can be changed in the following menus.

OSD LANGUAGE
PRESENT TIME SETUP
DISPLAY ORIENTATION

From the second time on, the below screen is displayed for a while (setting condition is an example).

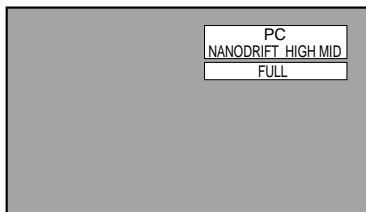

Selecting the input signal

Select the input signals to be connected by installing the optional Terminal Boards.



Press to select the input signal to be played back from the equipment which has been connected to the Plasma Display.

Input signals will change as follows:

→ INPUT1 → INPUT2A → INPUT2B → INPUT3 → PC

SLOT2 is for dual input so that you can select INPUT2A or INPUT2B for INPUT2.

INPUT2A : HDMI signal terminal in SLOT2

INPUT2B : HDMI signal terminal in SLOT2

Notes:

- Selecting is also possible by pressing the INPUT button on the unit.
- Input terminal will not be selected if the terminal board is not installed into the SLOT.
- Select to match the signals from the source connected to the component/RGB input terminals.
- In 2 screen display, the same input mode cannot be selected for the main picture and sub picture.
- Image retention (image lag) may occur on the plasma display panel when a still picture is kept on the panel for an extended period. The function that darkens the screen slightly is activated to prevent image retention, but this function is not the perfect solution to image retention.

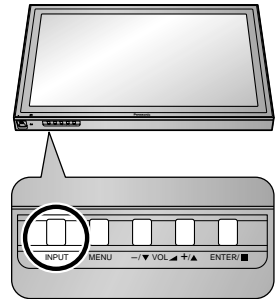
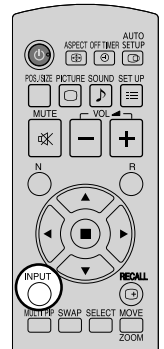

Basic Controls

Main Unit

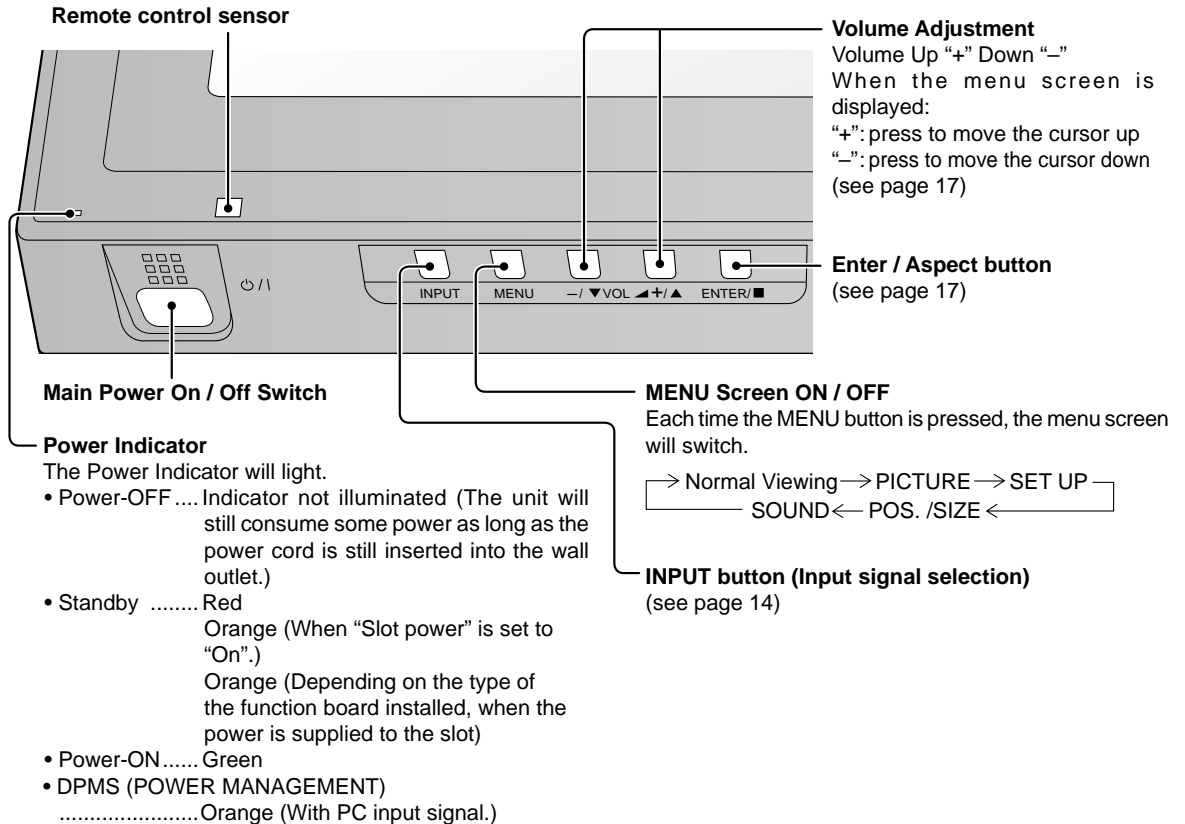

Basic Controls

Remote Control Transmitter

ACTION button

Press to make selections.

ASPECT button

Press to adjust the aspect.

Standby (ON / OFF) button

The Plasma Display must first be plugged into the wall outlet and turned on at the power switch (see page 12). Press this button to turn the Plasma Display On, from Standby mode. Press it again to turn the Plasma Display Off to Standby mode.

POS. /SIZE button

PICTURE button

Sound mute On / Off

Press this button to mute the sound. Press again to reactivate sound. Sound is also reactivated when power is turned off or volume level is changed.

N button

POSITION buttons

INPUT button

Press to select INPUT1, INPUT2, INPUT3 and PC input SLOTS sequentially. (see page 14)
When a dual input terminal board is attached, A or B is displayed depending on the selected input signal. (Ex. INPUT1A, INPUT1B)

MULTI Window buttons

OFF TIMER button

The Plasma Display can be preset to switch to standby after a fixed period. The setting changes to 30 minutes, 60 minutes, 90 minutes and 0 minutes (off timer cancelled) each time the button is pressed.

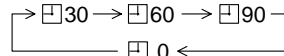

When three minutes remain, "OFF TIMER 3" will flash. The off timer is cancelled if a power interruption occurs.

AUTO SETUP button

Automatically adjusts the position/size of the screen.

SET UP button

SOUND button

Volume Adjustment

Press the Volume Up "+" or Down "-" button to increase or decrease the sound volume level.

R button (see page 17)

Press the R button to return to previous menu screen.

RECALL button

Press the "RECALL" button to display the current system status.

- ① Input label
NANODRIFT HIGH/LMD
- ② Aspect mode
4:3
- ③ Off timer
The off timer indicator is displayed only when the off timer has been set.
- ④ Clock display

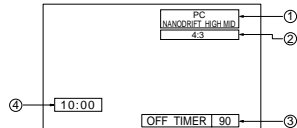

Digital Zoom

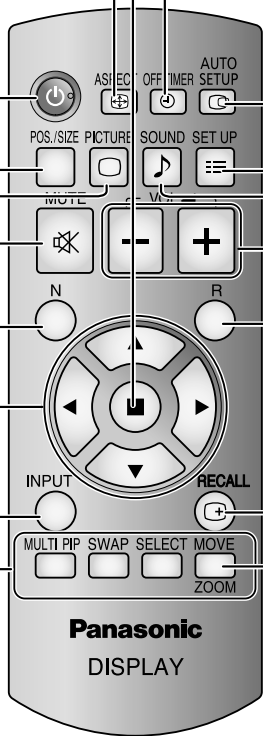

On-Screen Menu Displays

Remote Control

Unit

1 Display the menu screen.

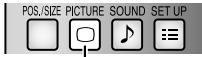

Press to select.
(Example: PICTURE menu)



Press several times.

Each time the MENU button is pressed, the menu screen will switch.

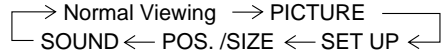

2 Select the item.

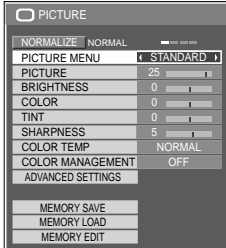

(Example:
PICTURE menu)

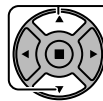

Select.

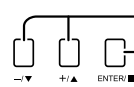

1 Select.

2 Press.

3 Set.

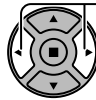

Set.

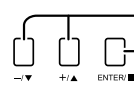

1 Set.

2 Press.

4 Exit the menu.

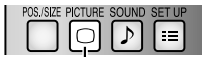

Press.

Press to return to the previous menu.



Press several times.

On-Screen Menu Displays

Overview

Note: Menu that cannot be adjusted is grayout. Adjustable menu changes depending on signal, input and menu setting.

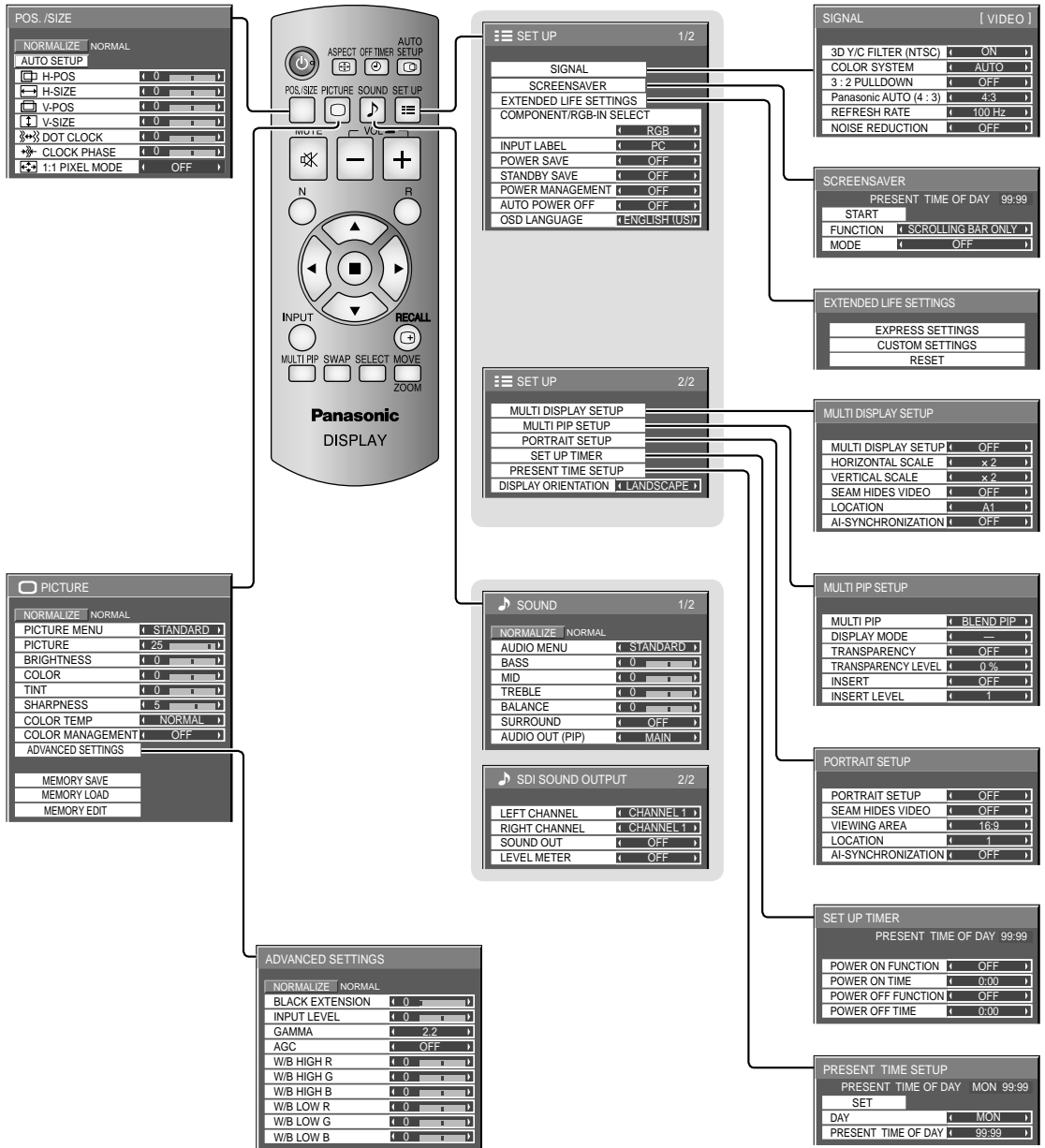

Specifications

	TH-58PF12UK	TH-65PF12UK
Power Source	110 - 127 V AC, 50/60 Hz	
Power Consumption		
Power on	715 W	745 W
Stand-by condition	Save OFF 1.0 W, Save ON 0.5 W	Save OFF 1.0 W, Save ON 0.5 W
Power off condition	0.2 W	0.2 W
Plasma Display panel	Drive method : AC type 58-inch, 16:9 aspect ratio	Drive method : AC type 65-inch, 16:9 aspect ratio
Screen size	50.5" (1,284 mm) (W) × 28.4" (722 mm) (H) × 58.0" (1,473 mm) (diagonal)	56.4" (1,434 mm) (W) × 31.7" (806 mm) (H) × 64.7" (1,645 mm) (diagonal)
(No. of pixels)	2,073,600 (1,920 (W) × 1,080 (H)) [5,760 × 1,080 dots]	
Operating condition		
Temperature	32 °F - 104 °F (0 °C - 40 °C)	
Humidity	20 % - 80 %	
Applicable signals		
Scanning format	525 (480) / 60i · 60p, 625 (575) / 50i · 50p, 750 (720) / 60p · 50p, 1125 (1080) / 60i · 60p · 50i · 50p · 24p · 25p · 30p · 24sF, 1250 (1080) / 50i	
PC signals	VGA, SVGA, XGA, SXGA UXGA (compressed) Horizontal scanning frequency 15 - 110 kHz Vertical scanning frequency 48 - 120 Hz	
Connection terminals		
HDMI A-B	TYPE A Connector × 2	
COMPONENT/RGB IN	Y/G (BNC) P _B /B (BNC), P _R /R (BNC) AUDIO IN (RCA PIN JACK × 2)	with sync 1.0 Vp-p (75 Ω) 0.7 Vp-p (75 Ω) 0.5 Vrms
PC IN	(HIGH-DENSITY MINI D-SUB 15PIN) AUDIO IN (M3 JACK)	Y or G with sync 1.0 Vp-p (75 Ω) Y or G without sync 0.7 Vp-p (75 Ω) B/P _B /C _B : 0.7 Vp-p (75 Ω) R/P _R /C _R : 0.7 Vp-p (75 Ω) HD/VD: 1.0 - 5.0 Vp-p (high impedance) 0.5 Vrms
SERIAL	EXTERNAL CONTROL TERMINAL (D-SUB 9PIN)	RS-232C COMPATIBLE
SPEAKERS	6 Ω, 16 W [8 W + 8 W] (10 % THD)	8 Ω, 20 W [10 W + 10 W] (10 % THD)
Accessories Supplied		
Remote Control Transmitter	N2QAYB000432	
Batteries	AA Size × 2	
Fixing band	TMME203 × 1	
Dimensions (W × H × D)	55.1" (1,399 mm) × 33.2" (843 mm) × 3.9" (99 mm)	61.2" (1,554 mm) × 36.5" (925 mm) × 3.9" (99 mm)
Mass (weight)		
main unit only	approx. 105.8 lbs	approx. 130.0 lbs
with speakers	approx. 116.8 lbs	approx. 143.3 lbs

Note:

Design and specifications are subject to change without notice. Mass and dimensions shown are approximate.

(for the U.S.A and Puerto Rico)

Panasonic Professional Display Company
Unit of Panasonic Corporation of
North America
One Panasonic Way 1F-10
Secaucus, NJ 07094

**Panasonic Professional Flat Panel Display
Limited Warranty**

Panasonic Professional Display Company, (referred to as "the Warrantor") will repair this product and all included accessories with new or refurbished parts, free of charge in the USA or Puerto Rico, of the original purchase in the event of a defect in materials or workmanship as follows:

Models or Parts	Part Warranty	Labor Warranty
Professional Flat Panel Display	2 Years	2 Years

On-site or carry-in service in the **USA and Puerto Rico** may be obtained during the warranty period by contacting Panasonic Professional Display Company Service toll free at 1-800-973-4390.

This warranty is extended only to the original purchaser and is non transferable. A purchase receipt or other proof of date of original purchase will be required before warranty service is rendered.

This warranty only covers failures due to defects in materials or workmanship, which occur during normal use. The warranty does not cover damage which occur in shipment, or failures which are caused by products not supplied by the warrantor, or failures which result from improper installation, set-up adjustments, improper

antenna, inadequate signal pickup, maladjustment of consumer controls, improper operation, power line surge, improper voltage supply, lighting damage, or service by anyone other than an authorized repair facility, or damage that is attributable to acts of God.

LIMITS AND EXCLUSIONS

There are no express warranties except as listed above.

THE WARRANTOR SHALL NOT BE LIABLE FOR INCIDENTAL OR CONSEQUENTIAL DAMAGES (INCLUDING, WITHOUT LIMITATION, DAMAGE TO DISCS) RESULTING FROM THE USE OF THIS PRODUCT, OR ARISING OUT OF ANY BREACH OF THE WARRANTY. ALL EXPRESS AND IMPLIED WARRANTIES, INCLUDING THE WARRANTIES OF MERCHANTABILITY AND FITNESS FOR PARTICULAR PURPOSE, ARE LIMITED TO THE APPLICABLE WARRANTY PERIOD SET FORTH ABOVE.

Some states do not allow the exclusion or limitation of incidental or consequential damages, or limitations on how long an implied warranty lasts, so the above exclusions or limitations may not apply to you. This warranty gives you specific legal rights and you may have other rights, which vary from state to state.

If you have a problem with this product that is not handled to your satisfaction, then write the Consumer Affairs Department at the Company address indicated above.

In the USA and Puerto Rico
FOR SERVICE
CALL TOLL FREE
1-800-973-4390

(for Canada)

Panasonic Canada Inc.
5770 Ambler Drive, Mississauga, Ontario L4W 2T3
LIMITED WARRANTY STATEMENT

Panasonic Canada Inc. (also known as PCI) warrants this product to be free of defects in material and workmanship under normal use during the applicable warranty coverage period described below. PCI agrees to repair, or at its option, exchange, any part that becomes defective. However, the product must be purchased and serviced in Canada. The product or part that shows evidence of defect must be delivered prepaid or carried in to an authorized Panasonic Broadcast Service Center. This warranty does not cover shipping costs.

The warranty coverage period is one year for both parts and labour beginning with the date of original end user purchase, subject to the exceptions as stated below. Repaired or replacement parts supplied during the warranty coverage period carry the unexpired portion of the original warranty coverage period. Proof of product purchase is a condition of warranty service. The owner must produce the product purchase receipt or other satisfactory evidence of date of original purchase.

This warranty does not apply to external appearance items, such as handles, knobs, safety windows, etc. This warranty does not apply to any part, or parts, of the product, installed, altered, repaired or misused in any way that, in the opinion of PCI, affects the reliability of or detracts from the performance of the product.

For products requiring routine preventive maintenance, that maintenance must be performed in order to maintain warranty coverage.

Serial numbers that have been altered, defaced or removed void this warranty. This warranty does not cover replacements or repairs necessitated by loss or damage resulting from any cause beyond the control of PCI.

Marking or retained images (sometimes called "burn-in") resulting from the display of fixed images on video display products are not defects and are not covered under this warranty.

THIS EXPRESS, LIMITED WARRANTY IS IN LIEU OF ALL OTHER WARRANTIES, EXPRESS OR IMPLIED, INCLUDING ANY IMPLIED WARRANTIES OF MERCHANTABILITY AND FITNESS FOR A PARTICULAR PURPOSE. IN NO EVENT WILL PANASONIC CANADA INC. BE LIABLE FOR ANY SPECIAL, INDIRECT OR CONSEQUENTIAL DAMAGES.

In certain instances, some jurisdictions do not allow the exclusion or limitation of incidental or consequential damages, or the exclusion of implied warranties, so the above limitations and exclusions may not be applicable.

WARRANTY COVERAGE PERIOD EXCEPTIONS

Item	Parts	Labour
Video Tape	30 days—Replacement only (content not covered)	N/A
P2/SD Cards	(Content not covered)	N/A
Video Heads	1 year or 2,000 hrs. (prorated) Whichever comes first	1 year or 2,000 hrs. Whichever comes first
D5 Video heads	1 year or 1,000 hrs. Whichever comes first	1 year or 1,000 hrs. Whichever comes first
Maintenance Items	90 days	90 days
Colour Camera CCD Imaging Block	2 years	1 year
BT-H Series LCD Monitors	2 years	1 year
* DLP™ Projectors	3 years or 17,000 hrs. Whichever comes first	3 years or 17,000 hrs. Whichever comes first
* LCD Projectors above 2,500 ANSI Lumens	3 years or 2,500 hrs. Whichever comes first	3 years or 2,500 hrs. Whichever comes first.
* LCD Projectors below 2,500 ANSI Lumens	3 years or 1,500 hrs. Whichever comes first	3 years or 1,500 hrs. Whichever comes first
Projector Lamps	50% of the rated lamp life or 1 year. Whichever comes first	50% of the rated lamp life or 1 year. Whichever comes first.
103 inch Plasma displays	3 year (burn-in not covered)	3 year
Hard Drive Disk Unit	1 year plus balance (if any) of the original Manufacturer's Limited Warranty. (Content not covered)	1 year

- Dust, smoke, rental/staging environment and twenty-four/seven operation, dramatically decreases the interval between performances of routine preventive maintenance required to maintain this warranty coverage.

Warranty Service

If the product needs to be shipped for service, carefully pack (preferably in the original carton) and enclose a letter, detailing the complaint. Send prepaid and adequately insured to the local authorized Panasonic Service Centre in your area or to Panasonic Technical Support and Product Services Department, 5770 Ambler Drive, Mississauga, Ontario, L4W 2T3. Shipping to the latter location requires a return authorization before shipment. No liability is assumed for loss or damage to the product while in transit.

Customer Service

Customer Service Directory

Obtain information products and operative assistant; localize the closer distributor or Service Center; buy spare parts and accessories by our web site to Latin American:

<http://www.lar.panasonic.com>

Also you may contact us directly by our Contact Center:

Panama	800-PANA (800-7262)
Colombia	1-8000-94PANA (1-8000-947262) - National Line 635-PANA (635-7262) - Bogota Line
Ecuador	1800-PANASONIC (1800-726276)
Costa Rica	800-PANA737 (800-7262737)
El Salvador	800-PANA (800-7262)
Guatemala	1-801-811-PANA (1-801-811-7262)
Chile	800-260602 From a cell phone: 245-2520
Venezuela	800-PANA-800 (800-7262-800)
Uruguay	0-800-PANA (0800-7262)

Mexico Service

To obtain information in the Republic of Mexico contact us at:

[email: atencion.clientes@mx.panasonic.com](mailto:atencion.clientes@mx.panasonic.com)

Or you may contact us in the next following phones numbers:

01800-VIP-PANA (01800-847-7262) - Interior
(55) 5000-1200 - Mexico D.F. and Metropolitan Area

A series of horizontal dashed lines for writing notes.

Customer's Record

The model number and serial number of this product can be found on its back cover. You should note this serial number in the space provided below and retain this book, plus your purchase receipt, as a permanent record of your purchase to aid in identification in the event of theft or loss, and for Warranty Service purposes.

Model Number _____

Serial Number _____

© Panasonic Corporation 2009

Panasonic Professional Display Company
Unit of Panasonic Corporation of North America

Executive Office :
One Panasonic Way 1F-10, Secaucus, NJ 07094

Panasonic Canada Inc.
5770 Ambler Drive
Mississauga, Ontario
L4W 2T3