

# Panasonic®



Scan, watch and discover how to get the most out of your TV

Escanee, observe y escubra como obtener el máximo de su TV

<http://SCN.BY/9T9AB0HTW8JBK3>

Model No.  
Número de modelo

**TC-P42X60**  
**TC-P50X60**

## Owner's Manual

42"/50" Class 720p Plasma  
HDTV

(41.9/49.9 inches measured diagonally)

## Manual de usuario

Televisión de alta definición de  
720p y clase 42"/50" de Plasma

(41,9/49,9 pulgadas medidas  
diagonalmente)

# VIERA

For assistance (U.S.A./Puerto Rico), please call:

**1-877-95-VIERA (958-4372)**

[www.panasonic.com/help](http://www.panasonic.com/help)

For assistance (Canada), please call:

**1-866-330-0014**

[concierge.panasonic.ca](http://concierge.panasonic.ca)

Para solicitar ayuda (EE.UU./Puerto Rico), llame al:

**1-877-95-VIERA (958-4372)**

[www.panasonic.com/help](http://www.panasonic.com/help)



## Register online at

[www.panasonic.com/register](http://www.panasonic.com/register)

(U.S. customers only)

### English

Thank you for purchasing this Panasonic product. Please read these instructions before operating your set and retain them for future reference. The images shown in this manual are for illustrative purposes only.

### Español

Gracias por su decisión de comprar este producto marca Panasonic. Lea estas instrucciones antes de utilizar su televisor y guárdelas para consultarlas en el futuro. Las imágenes mostradas en este manual tienen solamente fines ilustrativos.



TQB2AA0705

**This product incorporates the following software:**

- (1) the software licensed under the GNU General Public License, Version 2.0 (GPL V2.0) and/or,
- (2) open sourced software other than the software licensed under the GPL.

The software categorized as (1) - (2) are distributed in the hope that it will be useful, but WITHOUT ANY WARRANTY, without even the implied warranty of MERCHANTABILITY or FITNESS FOR A PARTICULAR PURPOSE. Please refer to the detailed terms and conditions thereof shown in the "License" menu on this product.

At least three (3) years from delivery of this product, Panasonic Corporation will give to any third party who contacts us at the contact information provided below, for a charge no more than our cost of physically performing source code distribution, a complete machine-readable copy of the corresponding source code covered under GPL V2.0 or the other licenses with the obligation to do so, as well as the respective copyright notice thereof.

Contact Information: [cdrequest@unipf.jp](mailto:cdrequest@unipf.jp)

The source code and the copyright notice are also available for free in our website below.  
<http://www.unipf.jp/dl/DTV13UM/>

This product is licensed under the AVC patent portfolio license for the personal and non-commercial use of a consumer to (i) encode video in compliance with the AVC Standard ("AVC Video") and/or (ii) decode AVC Video that was encoded by a consumer engaged in a personal and non-commercial activity and/or was obtained from a video provider licensed to provide AVC Video. No license is granted or shall be implied for any other use. Additional information may be obtained from MPEG LA, LLC.  
 See <http://www.mpegla.com>.

**■ Do not display a still picture for a long time**

This causes the image to remain on the plasma screen ("Image retention").

This is not considered a malfunction and is not covered by the warranty.



To prevent the "Image retention", the screen saver is automatically activated after a few minutes if no signals are sent or no operations are performed.

**Typical still images**

- Channel number and other logos
- Image displayed in 4:3 mode
- Photo    ● Video game

**■ Set up**

- Do not place the unit where it's exposed to sunlight or other bright light (including reflections).
- Use of some types of fluorescent lighting may reduce the remote control's transmission range.

# HDMI

HDMI, the HDMI logo and High-Definition Multimedia Interface are trademarks or registered trademarks of HDMI Licensing LLC in the United States and other countries.



**dts**  
2.0+Digital Out

Manufactured under license under U.S. Patent Nos: 5,956,674; 5,974,380; 6,487,535 & other U.S. and worldwide patents issued & pending. DTS, the Symbol, & DTS and the Symbol together are registered trademarks & DTS 2.0+Digital Out is a trademark of DTS, Inc. Product includes software. © DTS, Inc. All Rights Reserved.



**DOLBY**  
DIGITAL

Manufactured under license from Dolby Laboratories. Dolby and the double-D symbol are trademarks of Dolby Laboratories.



**HDTV**

# Contents

## Please read before using the unit

- Safety Precautions ..... 4

## Getting started

- Accessories/Optional Accessory ..... 8
- Connections ..... 11
- Identifying Controls ..... 13
- First Time Setup ..... 15

## Basic Features

- Watching TV ..... 16
- Watching content from external devices ... 19
- Using Media player ..... 20

## Advanced Features

- How to Use Menu Functions ..... 21

## Support Information

- Technical Information ..... 26
- Care and Cleaning ..... 31
- Frequently Asked Questions (FAQ) ... 32
- Specifications ..... 34
- Index ..... 35
- Limited Warranty  
(for U.S.A. and Puerto Rico only) ..... 36
- Customer Services Directory  
(for U.S.A. and Puerto Rico) ..... 37
- Limited Warranty (for Canada) ..... 38

Getting started

Basic

Advanced

Support Information



# Safety Precautions

	<b>CAUTION</b> <b>RISK OF ELECTRIC SHOCK</b> <b>DO NOT OPEN</b>	
<b>WARNING:</b> To reduce the risk of electric shock, do not remove cover or back. No user-serviceable parts inside. Refer servicing to qualified service personnel.		



The lightning flash with arrowhead within a triangle is intended to tell the user that parts inside the product are a risk of electric shock to persons.

The exclamation point within a triangle is intended to tell the user that important operating and servicing instructions are in the papers with the appliance.

**WARNING:** To reduce the risk of fire or electric shock, do not expose this apparatus to rain or moisture. Do not place liquid containers (flower vase, cups, cosmetics, etc.) above the set (including on shelves above, etc.).

## Important Safety Instructions

- 1) Read these instructions.
- 2) Keep these instructions.
- 3) Heed all warnings.
- 4) Follow all instructions.
- 5) Do not use this apparatus near water.
- 6) Clean only with dry cloth.
- 7) Do not block any ventilation openings. Install in accordance with the manufacturer's instructions.
- 8) Do not install near any heat sources such as radiators, heat registers, stoves, or other apparatus (including amplifiers) that produce heat.
- 9) Do not defeat the safety purpose of the polarized or grounding-type plug. A polarized plug has two blades with one wider than the other. A grounding type plug has two blades and a third grounding prong. The wide blade or the third prong are provided for your safety. If the provided plug does not fit into your outlet, consult an electrician for replacement of the obsolete outlet.
- 10) Protect the power cord from being walked on or pinched particularly at plugs, convenience receptacles, and the point where they exit from the apparatus.
- 11) Only use attachments / accessories specified by the manufacturer.
- 12) Use only with the cart, stand, tripod, bracket, or table specified by the manufacturer, or sold with the apparatus. When a cart is used, use caution when moving the cart / apparatus combination to avoid injury from tip-over.
- 13) Unplug this apparatus during lightning storms or when unused for long periods of time.
- 14) Refer all servicing to qualified service personnel. Servicing is required when the apparatus has been damaged in any way, such as power-supply cord or plug is damaged, liquid has been spilled or objects have fallen into the apparatus, the apparatus has been exposed to rain or moisture, does not operate normally, or has been dropped.
- 15) To prevent electric shock, ensure the grounding pin on the AC cord power plug is securely connected.



**⚠ WARNING**

Small parts can present choking hazard if accidentally swallowed.

Keep small parts away from young children. Discard unneeded small parts and other objects, including packaging materials and plastic bags/sheets to prevent them from being played with by young children, creating the potential risk of suffocation.

**■ Set up**

This Plasma TV may fall and can cause personal injury or even death if not installed correctly. To prevent personal injury or death, follow these warnings:

- **Install the Plasma TV in accordance with the manufacturer's recommended pedestal or stand, corresponding hardware and installation instructions.**  
This Plasma TV is for use only with the following optional accessories. Use with any other type of optional accessories may cause instability. The following accessories are manufactured by Panasonic Corporation.
  - Wall-hanging bracket (Angled)  
TY-WK4P1RW
- **Be sure to ask a qualified technician to carry out the installation and set-up.**  
Two or more people are required to install or remove the television.
- **Some wall mounts (wall-hanging brackets) are not designed to be mounted to walls with steel studs or old cinder block constructions.**  
Ask your dealer or licensed contractor to properly secure the wall-hanging bracket.
- **Do not route the TV's power cord inside the wall.**  
The power cord was not designed for in-wall mounting.  
Doing so can lead to fire hazard.
- **Do not place the Plasma TV or its stand on a sloped or unstable surface.**  
The Plasma TV may fall or tip over.
- **Do not support the Plasma TV on a non-specified pedestal.**
- **Do not place the Plasma TV on furniture that can easily be used as steps, such as a chest of drawers.**
- **Do not climb or allow children to climb on the Plasma TV**
- **Place or install the Plasma TV where it cannot be pushed, pulled over or knocked down.**
- **Route all cords and cables such that they cannot be tripped over or pulled by curious children.**
- **Do not place any objects on top of the Plasma TV.**  
If water spills onto the Plasma TV or foreign objects get inside it, a short-circuit may occur, which could result in fire or electric shock. If any foreign objects get inside the Plasma TV, please consult an Authorized Service Center.

- **In the unlikely event that you receive a shock from this product, it is possible that your household outlet may be wired improperly.** Have an electrician verify that the TV's outlet is properly wired. If the problem persists, have the TV serviced by a qualified authorized technician.

- **To prevent the spread of fire, keep candles or other open flames away from this product at all times**

**■ AC Power Supply Cord**

To prevent fire or electric shock:

- **The Plasma TV is designed to operate on a 120 V AC, 60 Hz service. Insert the power cord plug as far as it will go into the wall socket.**  
If the plug is not fully inserted, heat may generate, which could cause a fire.
- **The included power cord is for use with this unit only.**
- **Do not use any power cord other than that provided with this TV.**
- **Do not handle the power cord plug with wet hands.**
- **Do not do anything that might damage the power supply cord.**
- **When disconnecting the power supply cord, hold the plug, not the cord.**
- **Do not use the power supply cord if the plug or cord is damaged.**  
Replace the cord or contact your Authorized Service Center.
- **Do not use a 3-prong to 2-prong AC plug adapters to connect your TV's plug to the wall outlet.**  
Doing so will defeat the TV plug's safety feature, which can lead to a shock hazard. If the wall outlet does not accommodate a 3-prong plug, have a qualified electrician replace your outlet and check the associated wiring.

**■ Handling the power supply cord**

- **Insert the power plug fully into the socket outlet. (If the power plug is loose, it could generate heat and cause fire.)**
- **Ensure that the power plug is easily accessible.**
- **Ensure the earth pin on the power plug is securely connected to prevent electrical shock.**
  - An apparatus with CLASS I construction shall be connected to a power socket outlet with a protective earthing connection.
- **Do not touch the power plug with a wet hand. (This may cause electrical shock.)**
- **Do not use any power cord other than that provided with this TV. (This may cause fire or electrical shock.)**

● **Do not damage the power cord. (A damaged cord may cause fire or electrical shock.)**

- Do not move the TV with the cord plugged in the socket outlet.
- Do not place a heavy object on the cord or place the cord near a high-temperature object.
- Do not twist the cord, bend it excessively, or stretch it.
- Do not pull on the cord. Hold onto the power plug body when disconnecting cord.
- Do not use a damaged power plug or socket outlet.

● **If a problem occurs (such as no picture or no sound), or if smoke or an abnormal odor is detected from the Plasma TV, unplug the power supply cord immediately.**

Continued use of the TV under these conditions might cause a fire or permanent damage to the TV. Have the TV evaluated by an Authorized Service Center. Servicing of the TV by unauthorized personnel is strongly discouraged due to its high voltage.

● **If water or an object gets inside the Plasma TV, if the Plasma TV is dropped, or if the enclosure becomes damaged, unplug the power supply cord immediately.**

A short-circuit may occur, which could cause a fire. Contact an Authorized Service Center for an evaluation.

 **CAUTION**

● **Do not cover the ventilation holes.**

Doing so may cause the Plasma TV to overheat, which can cause a fire or damage to the Plasma TV.

● **Leave a space of 3 15/16" (10 cm) or more at the top, left and right, and 2 3/4" (7 cm) or more at the rear.**

● **When using the pedestal, keep the space between the bottom of the TV and the pedestal or stand surface clear from objects that may obstruct ventilation.**

■ **When Moving the Plasma TV**

● **Be sure to disconnect all cables before moving the Plasma TV.**

Moving the TV with its cables attached might damage the cables which, in turn, can cause fire or electric shock.

● **To prevent an electric shock, disconnect the power plug from the wall outlet as a safety precaution before carrying out any cleaning.**

● **Transport only in upright position.**

Transporting the unit with its display panel facing upright or downward may cause damage to the internal circuitry.

● **Using a dry cloth, clean any dust from the power supply cord and plug regularly.**

Build-up of dust on the power cord plug can increase humidity, which might damage the insulation and cause a fire.

**This Plasma TV radiates infrared rays;**

therefore, it may affect other infrared communication equipment. Install your infrared sensor in a place away from direct or reflected light from your Plasma TV.

**The TV will still consume some power as long as the power supply cord is connected to the wall outlet.**

● **Display panel is made of glass. Do not apply strong force or impact to the display panel.**

This may cause damage resulting in injury.

● **The TV is heavy. TV should be handled by 2 or more people. Support as shown below to avoid injury by the TV from tipping or falling.**

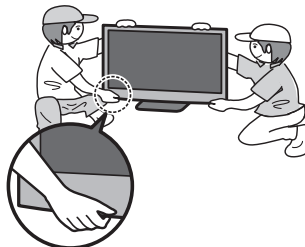

### WARNING

Flat panel displays are not always supported on the proper stands or installed according to the manufacturer's recommendations. Flat panel displays that are inappropriately situated on dressers, bookcases, shelves, desks, speakers, chests or carts may fall over and may cause personal injury or even death.

The consumer electronics industry (of which Panasonic is a member) is committed to making home entertainment enjoyable and safe. To prevent personal injury or death, be sure to follow the following safety guidelines:

#### TUNE INTO SAFETY:

- One size does NOT fit all. Follow the manufacturer's recommendations for the safe installation and use of your flat panel display.
- Carefully read and understand all enclosed instructions for proper use of this product.
- Don't allow children to climb on or play with furniture and television sets.
- Don't place flat panel displays on furniture that can easily be used as steps, such as a chest of drawers.
- Remember that children can become excited while watching a program, especially on "larger than life" flat panel displays. Care should be taken to install the display where it cannot be pushed, pulled over, or knocked down.
- Care should be taken to route all cords and cables connected to the flat panel display so that they cannot be pulled or grabbed by curious children.

#### WALL MOUNTING: IF YOU DECIDE TO WALL MOUNT YOUR FLAT PANEL DISPLAY, ALWAYS:

- Use a mount that has been recommended by the display manufacturer and/or listed by an independent laboratory (such as UL, CSA, ETL).
- Follow all instructions supplied by the display and wall mount manufacturers.
- If you have any doubts about your ability to safely install your flat panel display, contact your retailer about professional installation.
- Make sure the wall where you are mounting the display is appropriate. Some wall mounts are not designed to be mounted to walls with steel studs or old cinder block construction. If you are unsure, contact a professional installer.
- A minimum of two people are required for installation. Flat panel displays can be heavy.

**Panasonic recommends that a qualified installer perform the wall-mount installation. See page 5.**

**The American Academy of Pediatrics discourages media viewing for children younger than two years. For more details, see [www.aap.org](http://www.aap.org).**



## FCC STATEMENT

This equipment has been tested and found to comply with the limits for an Other Class B digital device, pursuant to Part 15 of the FCC Rules. These limits are designed to provide reasonable protection against harmful interference in a residential installation.

This equipment generates, uses and can radiate radio frequency energy and, if not installed and used in accordance with the instructions, may cause harmful interference to radio communications. However, there is no guarantee that interference will not occur in a particular installation. If this equipment does cause harmful interference to radio or television reception, which can be determined by turning the equipment off and on, the user is encouraged to try to correct the interference by one or more of the following measures:

- Reorient or relocate the receiving antenna.
- Increase the separation between the equipment and receiver.
- Connect the equipment into an outlet on a circuit different from that to which the receiver is connected.
- Consult the Panasonic Service Center or an experienced radio/TV technician for help.

#### FCC Caution:

**To assure continued compliance, follow the attached installation instructions and use only shielded interface cables when connecting to peripheral devices. Some recommended user provided interface cables may require usage of the attached ferrite core kit(s), refer to interface cable connection instructions for details. Any changes or modifications not expressly approved by Panasonic Corp. of North America could void the user's authority to operate this device.**

Responsible Party:	Panasonic Corporation of North America One Panasonic Way, Secaucus, NJ 07094
Contact Source:	Panasonic Consumer Marketing Company of North America 1-877-95-VIERA (958-4372)
email:	<a href="mailto:consumerproducts@panasonic.com">consumerproducts@panasonic.com</a>

# Accessories/Optional Accessory

## Accessories

Check if you have all of the items shown below.

- Remote Control  
● N2QAYB000820



- Batteries (2)  
● AA Battery

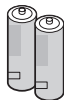

- Power cord

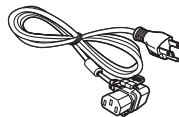

- Owner's Manual  
 Quick start guide  
 Child safety  
 Product Registration Card (U.S.A.)

- Pedestal

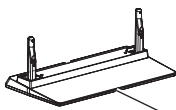

Assembly (p. 9)

- Ferrite core for HDMI cable (2)



## Optional Accessory

Please contact your nearest Panasonic dealer to purchase the recommended optional accessories. For additional details, please refer to the optional accessories installation manual.

### Wall-hanging bracket

- TY-WK4P1RW

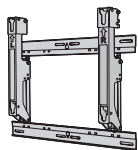

- a: 15.7" (400 mm)  
b: 11.8" (300 mm)

The angle of wall-hanging bracket can be adjusted in "zero tilting (vertical)" and "5, 10 or 15-degree tilting" for this TV.

Rear of the TV

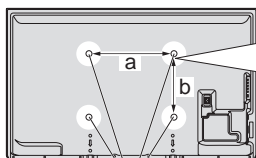

Holes for wall-hanging bracket installation

Screw for attaching the TV to the wall-hanging bracket (not supplied with the TV)

(View from the side)

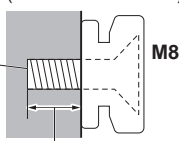

**Depth of screw:**  
minimum 0.67" (17.0 mm),  
maximum 1.38" (35.0 mm)

### Warning

- In order to maintain the TV's performance and safety, be absolutely sure to ask your dealer or a licensed contractor to secure the wall-hanging brackets.
- Carefully read the instructions accompanying optional accessories, and be absolutely sure to take steps to prevent the TV from tipping over.
- Handle the TV carefully during installation since subjecting it to impact or other forces may cause product damage.
- Take care when fixing wall brackets to the wall. Always ensure that there are no electrical cables or pipes in the wall before hanging bracket.
- When using the angled-type wall hanging bracket, please ensure that there is sufficient space for the connecting cables not to press against the wall when the TV is tilted forward.
- For safety reasons, remove units no longer being used from their wall-mounted locations.



## Assembling the pedestal

- Fix securely with assembly screws (A) (Total 4 screws).
- Tighten screws firmly.

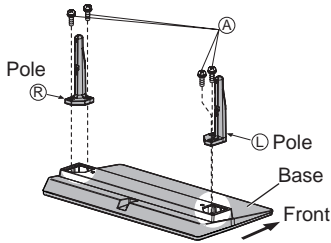

## Set-up

- Tighten assembly screws (B) (total 4 screws) loosely at first, then tighten them firmly to fix securely.

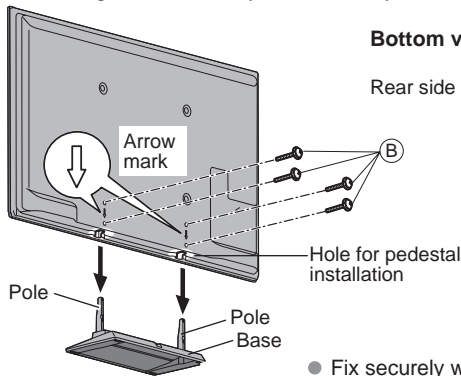

Work on a flat surface

- Fix securely with assembly screws (B) (Total 4 screws).

## Accessories

Assembly screws  
(4 of each)

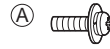

size (M5 x 18)



size (M5 x 30)

Poles (2)

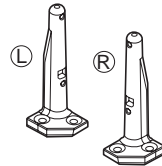

- (L) or (R) is printed at the bottom of the poles.

Base (1)

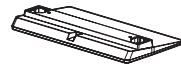

## Removing the pedestal from the TV

Be sure to remove the pedestal in the following way when using the wall hanging bracket or repacking the TV.

- ① Remove the assembly screws (B) from the TV.
- ② Lift the TV from the pedestal.
- ③ Remove the assembly screws (A) from the pole.

### Warning

**Do not disassemble or modify the pedestal.**

- Otherwise, the TV may fall over and become damaged, and personal injury may result.

### Caution

**Do not use any pedestal other than that provided with this TV.**

- Otherwise, the TV may fall over and become damaged, and personal injury may result.

**Do not use the pedestal if it becomes warped or physically damaged.**

- If you use the pedestal when it is physically damaged, personal injury may result. Contact your nearest Panasonic Dealer immediately.

**During set-up, make sure that all screws are securely tightened.**

- If sufficient care is not taken to ensure screws are properly tightened during assembly, the pedestal will not be strong enough to support the TV, and it might fall over and become damaged, and personal injury may result.

**When removing the pedestal, do not remove the pedestal by any methods other than the specified procedure. (above)**

- Otherwise, the TV and/or pedestal may fall over and become damaged, and personal injury may result.

## Power cord connection

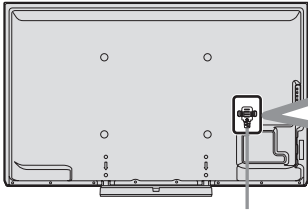

### To attach

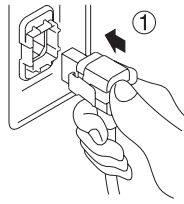

Insert it firmly until the tabs on both sides click into place.

### To remove

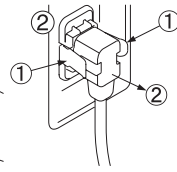

Keep pushing both sides until they snap and pull.

## Installing the remote's batteries

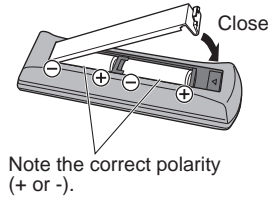
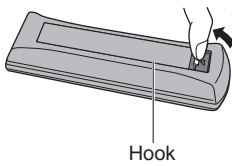

Note the correct polarity (+ or -).

### Caution

- Incorrect installation may cause battery leakage and corrosion, resulting in damage to the remote control.
- Do not mix old and new batteries.
- Do not mix different battery types (such as alkaline and manganese batteries).
- Do not use rechargeable (Ni-Cd) batteries.
- Do not burn or break batteries.

## Attaching Ferrite Core

Be sure to attach the provided ferrite core to the HDMI cable (not supplied) to reduce interference or electrical noise.

- 1 Attach the ferrite core as close as possible to connector on the TV side as shown.

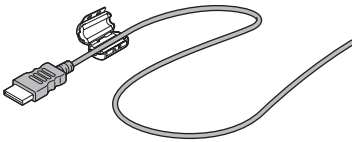

- 2 Close the ferrite core until it clicks.



# Connections

## Connection Panels

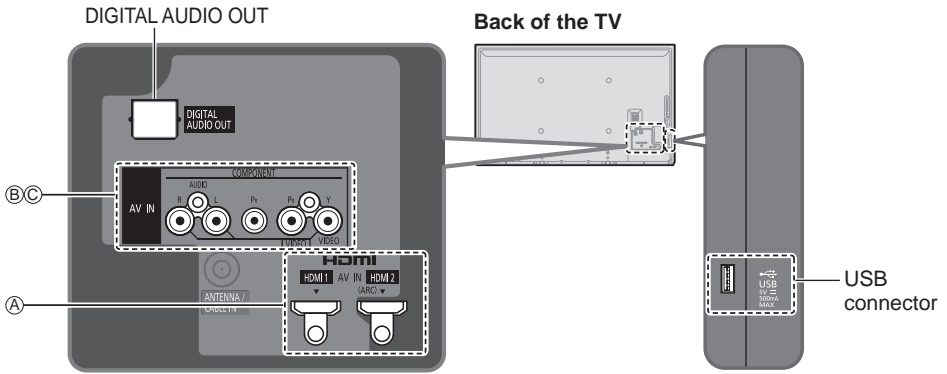

## Antenna or Cable connection

\* See page 10 (Power cord connection)

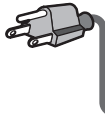
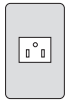

### Back of the TV

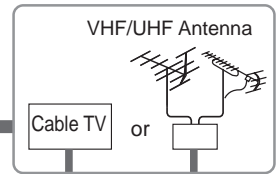
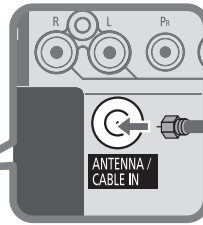
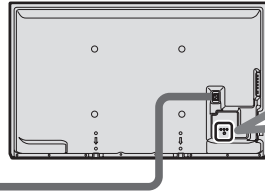

### Power Cord

Connect after all other connections have been made.

### VHF/UHF Antenna

- NTSC (National Television System Committee): Analog television system
- ATSC (Advanced Television Systems Committee): Digital TV Standards include digital high-definition television (HDTV), standard-definition television (SDTV), data broadcasting, multi-channel surround sound audio and interactive television.

### Cable

- You need to subscribe to a cable TV service to enjoy viewing their programming.
- A high-definition connection can be made using an HDMI or Component Video cable. (p. 12)

### Note

- When using a Cable box, external equipment and video cables shown in this manual are not supplied with the TV.
- When disconnecting the power cord, be absolutely sure to disconnect the power cord plug from the wall outlet first.
- For additional assistance, visit us at: [www.panasonic.com/help](http://www.panasonic.com/help)  
[www.panasonic.ca](http://www.panasonic.ca)

## AV cable connection

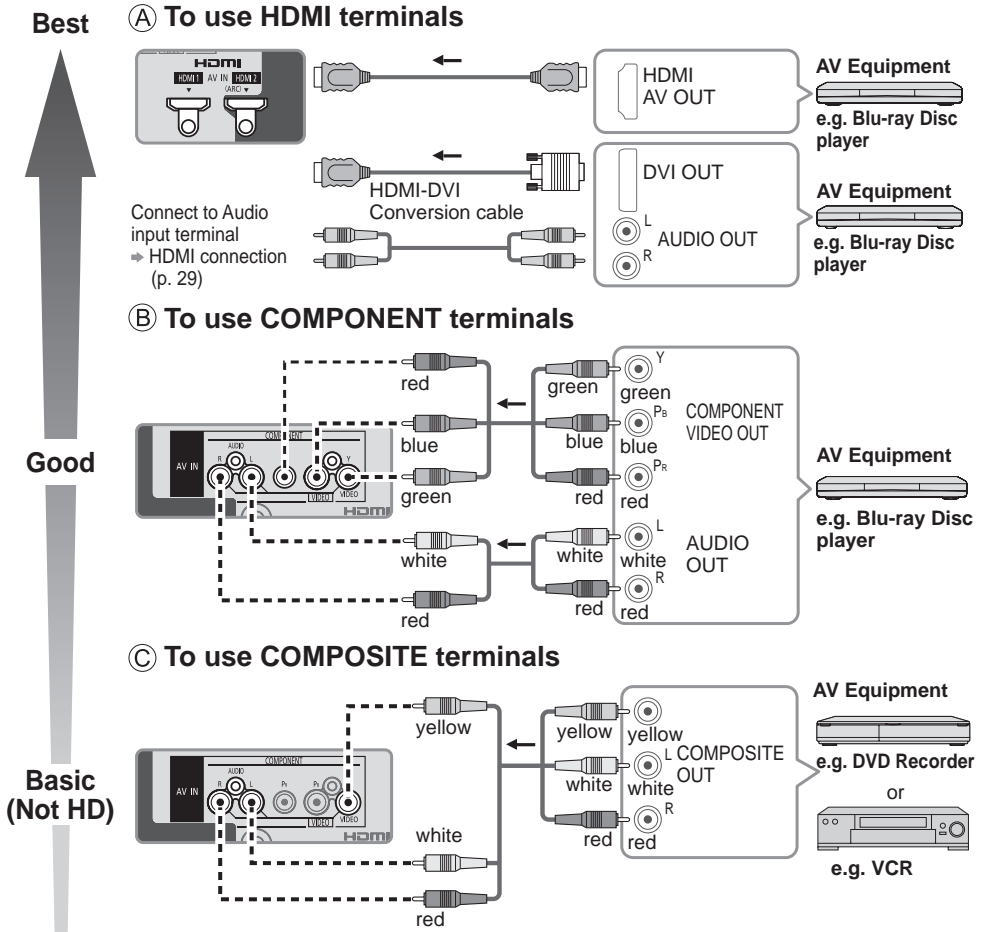

- The Green terminal is shared for both the COMPONENT and COMPOSITE (VIDEO IN) connection. When using COMPOSITE (VIDEO IN) connection, the Yellow connector (Video) should be inserted into Green connection. (Watching content from external devices (p. 19))

### Audio Return Channel (HDMI 2 terminal):

Audio Return Channel (ARC) is a function that enables digital sound signals to be sent via an HDMI cable back from the TV to a connected audio device.

## Audio connection

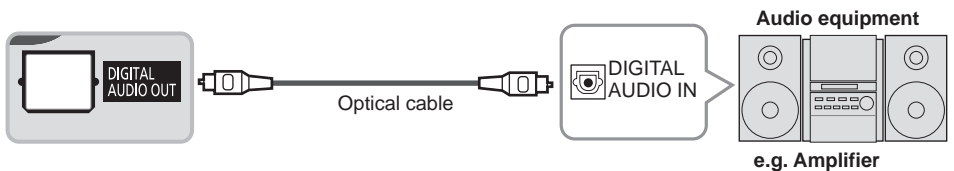

# Identifying Controls

## TV controls/indicators

### Front of the TV



C.A.T.S. sensor  
(Contrast Automatic Tracking  
System)

Power indicator  
(on: red, off: no light)

Remote control sensor  
Maximum range for remote is 23 feet (7 meters)  
from front of TV set

### Back of the TV

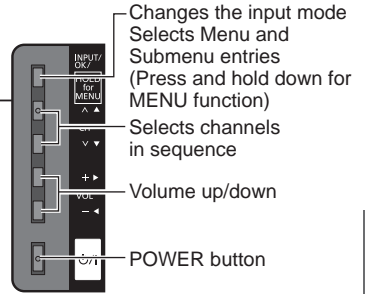
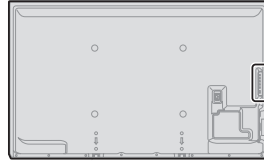

### Note

- The TV consumes a small amount of electric energy even when turned off.
- Do not place any objects between the TV remote control sensor and remote control.

## Remote control

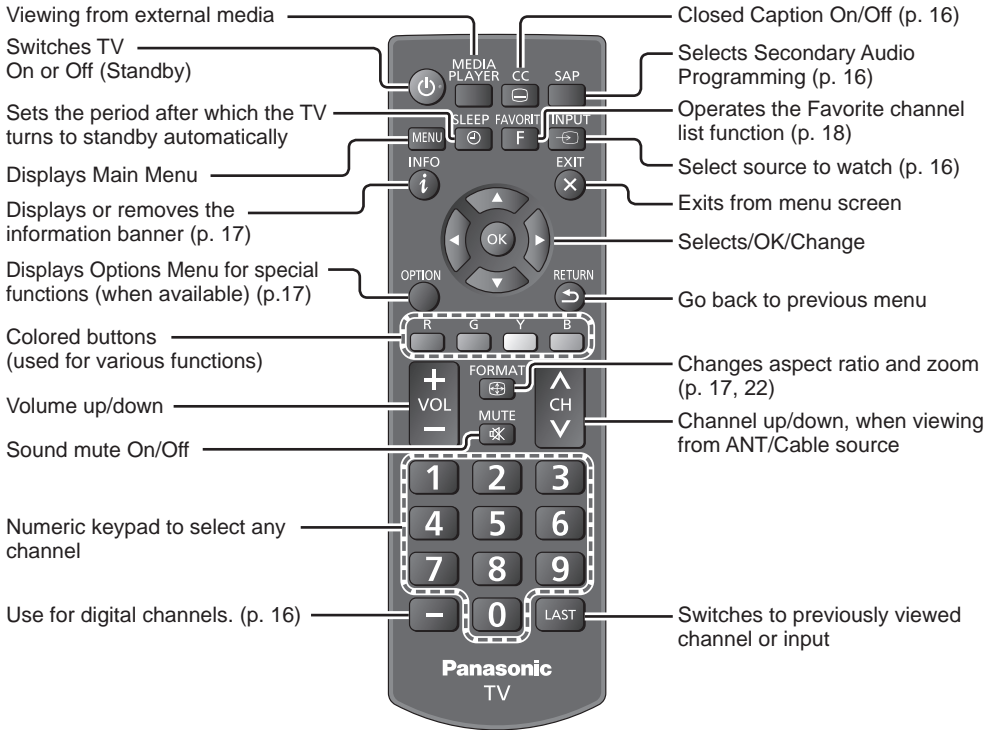

# First Time Setup

The setup screen will be displayed only when the TV is turned on for the first time and after the power cord is inserted into a wall outlet.

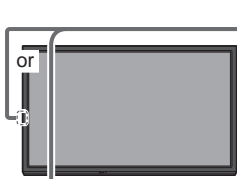

## 1 Turn the TV on with the POWER button (TV) (Remote)

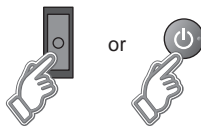

## 2 Setup the following items

- **Select your language**
- **Select your viewing mode (Be sure to select "Home Use")**  
If you select "Store Demonstration" by mistake, confirmation screen will be displayed.  
To display the "Set viewing mode" screen again and select "Home Use", perform "Reset to defaults" in the "Setup" menu.
- **ANT/Cable setup**  
Select signal type (Over-the-Air/Cable service).  
Select Auto Program and start scanning.  
Scanning starts.

### Note

If at the end of the scanning no channels are found, then check:

1. Antenna's position – or
2. Availability of Cable service

Cable, Satellite or Fiber services with a box are typically connected to the TV's A/V inputs, preferably HDMI, for best HD picture. In such a case, the channel scanning is not needed (set "ANT in" to "Cable").

## 3 Complete First time setup

Completion screen is displayed.

**You can repeat the First time setup**

- Press **MENU** → **Setup** → **Reset to defaults**

To watch TV via a Cable box, Satellite receiver, or any other source (DVD, DVR, gaming device, etc.), press the INPUT button and select the appropriate input.

# Watching TV



**1 Turn power on**  
(Remote) (TV)

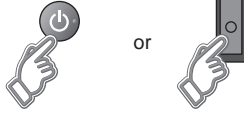

**Note**

● Please select correct input -->  (p. 19)

**2 Select a channel number**

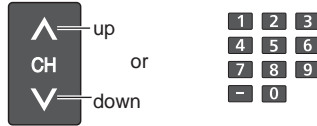

• CH buttons are also available on the side of the TV.

**[For Cable/Satellite box connection]**  
- Use your connected box's remote control.

■ **To directly enter a digital channel number**

 When tuning to a digital channel, press the button to enter the minor number in a compound channel number.

example:  
CH15-1: **1 5 - 1**

## ■ Other Useful Functions

### Listen with SAP (Secondary Audio Programming)

■ **Select the Audio mode for watching TV**



**Digital mode:** Select available audio service when receiving a digital channel.

**Analog mode:** Select the desired Audio mode. (Stereo/SAP/Mono)

- SAP is not available when watching TV with a Cable or Satellite box connected via HDMI.
- Contact your Cable or Satellite operator for instructions on enabling SAP with their box.

### Closed caption

■ **Switches the Closed caption mode**



**Digital TV:**

- Off/SERVICE 1 - 6

**Analog TV:**

- Off/CC1 - 4/ TEXT1 - 4

- Closed caption is not available when watching TV with a Cable or Satellite box connected via HDMI.
- Contact your Cable or Satellite operator for instructions on enabling CC with their box.



## Displaying Information

- Displays TV status information. Also, when watching programs via the Antenna/Cable input, INFO will include the channel banner.

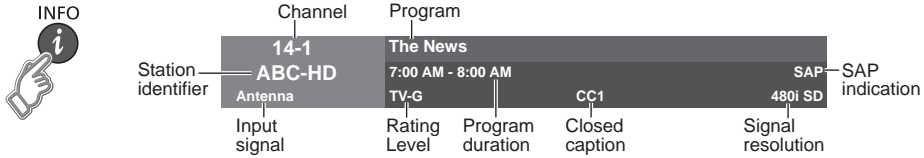

## Change aspect ratio and Zoom the picture

- Press **FORMAT** to cycle through the aspect modes (p. 22)

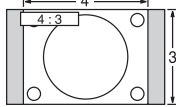

- 480i, 480p: FULL/4:3/JUST/ZOOM
- 1080p, 1080i, 720p: FULL/4:3/JUST/ZOOM/H-FULL

Use when the picture does not fill the whole screen (bars appear on either side of the image) or portions of the picture is trimmed.

### Note

1. Some content, such as film-based movies, are available in extra-wide format. Top and bottom bars are unavoidable.
2. Connected devices, such as Cable/Satellite box, DVD/Blu-ray players and game consoles have their own aspect (format) settings. Adjust the device's aspect settings.

## Display the Options menu

- Press **OPTION** to show the Options menu screen

This menu consists of shortcuts to convenient functions.

Options menu is only available when the TV is using the Antenna/Cable input, not when using Cable or Satellite box.

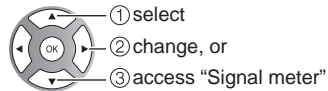

### Channel surf mode

Specify favorites or type of channels to view when pressing the channel up/down button.

- All/Favorite/Digital only/Analog only
- Favorite: Only channels registered as FAVORITE.

### Signal Meter

Check the signal strength if interference is found or freezing occurs on a digital image.

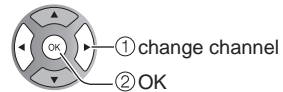

- If the signal is weak, check the antenna. If no problem is found, consult your local dealer.
- Not available if "Cable" is selected in "ANT in".
- Available only for digital antenna channels.

## Call up a Favorite channel

### ■ FAVORITE

Channel numbers registered in Favorite are displayed on the favorite tune screen. Select the desired broadcast station with the cursor.

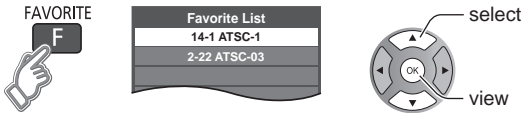

### ■ Set the Favorite channel

While viewing the channel that you want to set:



- When watching a Favorite channel, the icon ♥ will be displayed on the channel banner (p. 17).
- You can set up to 10 channels as Favorite.
- If you set a new channel in a used slot, the original Favorite channel will be replaced with the new setting.
- You cannot set Favorite channels when using Cable or Satellite box.

### ■ Delete a Favorite channel



- The icon ♥ will be removed from the channel banner (p. 17).

## Set Sleep Timer

The TV automatically goes into Standby after the selected period.

### ■ Press SLEEP repeatedly until the desired time appears.

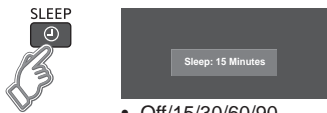

- Off/15/30/60/90 (minutes)

#### Note

- It is also possible to set the time from "Sleep Timer" in the "Setup" menu (p. 24).
- To cancel, set to "Off" or turn off the TV.
- When the remaining time is within 3 minutes, the remaining time will be displayed on screen.

# Watching content from external devices

- 1 With the connected equipment turned On  
**Display the Input select menu**



- 2 **Select the input mode**

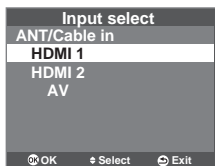

(example)

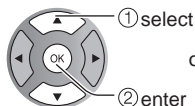

or Press INPUT repeatedly to cycle through the available inputs.



Label

(example)

- You can label or skip each input mode
  - Skipped inputs will be grayed out when the INPUT button is pressed.
- During the selection, if no action is taken for several seconds, the "Input select" menu disappears.
- The terminal and label (names) of the connected equipment are displayed.

- 3 **Operate the connected equipment directly or Use the remote control supplied with the equipment**

### Note

- For details, see the manual for the connected equipment.

# Using Media player

You can view still and motion images and play music saved on a USB flash memory device.

## Basic features for Media player

### Available contents and features

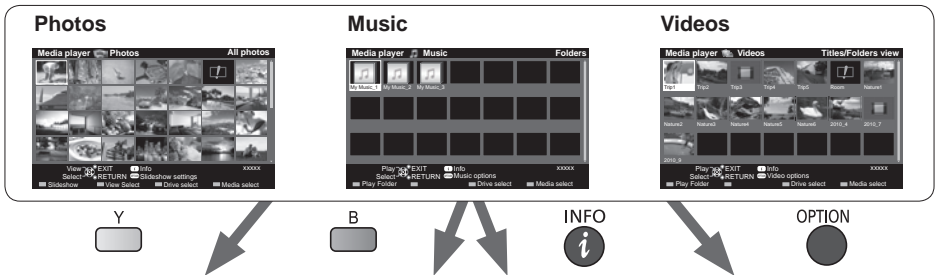

#### Drive select

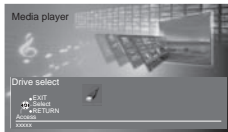

#### Media select

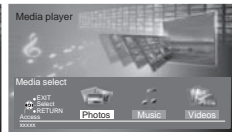

#### Information panel



#### Option menu

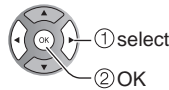
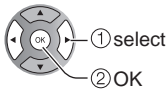
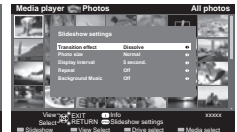

Displays data information.  
(File name, Date, and Size,  
etc.)

\*Information differs  
depending on selected  
data.

Option menu

- Photos
- Videos
- Music

## Media information

### Inserting or removing a USB flash memory device.

- Insert the device
- Remove the device

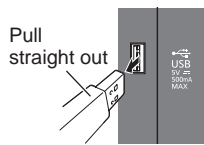
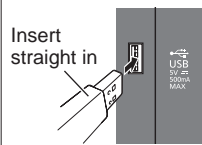

- Media player only supports USB Mass storage class devices.

# How to Use Menu Functions

Various menus allow you to set the picture, sound, and other functions so that you can enjoy watching TV best suited for you.

## 1 Display the menu



- Shows the functions that can be adjusted.
- Some functions will be disabled depending on the type of input signal.

### Menu structure

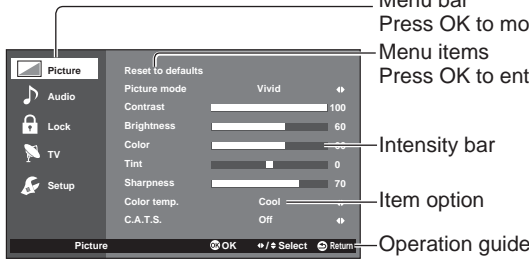

- Menu bar
- Press OK to move to the Menu items.
- Menu items
- Press OK to enter submenu page if available.
- Intensity bar
- Item option
- Operation guide

(example: Picture menu)

## 2 Select the menu

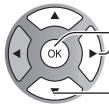
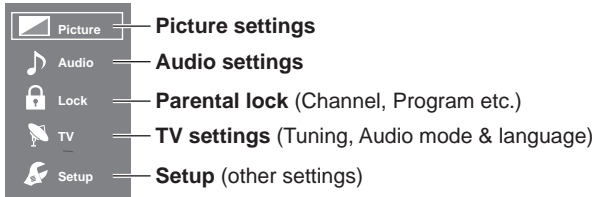

- ② move to menu item
- ① select

## 3 Select a menu item, then adjust or select the option

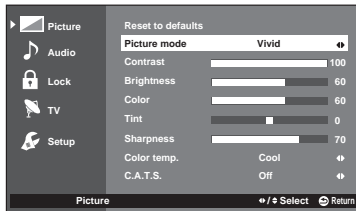

- ② adjust or select option
- ① select item

- Some items have submenu, press the OK button to enter the submenu

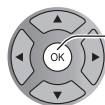
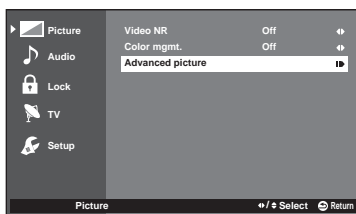

- ① enter submenu

## Picture settings Adjust the image or picture quality

Settings	Items	Item Description		
<b>Reset to defaults</b>		Resets all picture adjustments to factory default settings except for "Picture mode".		
<b>Picture mode</b>	<b>Vivid</b>	Provides enhanced picture contrast and sharpness for viewing in a well-lit room.		
	<b>Standard</b>	Recommended for normal viewing conditions with subdued room lighting.		
	<b>Cinema</b>	For watching movies in a darkened room. It provides a soft, film-like picture.		
	<b>Game</b>	For playing video games.		
	<b>Custom (Photo)</b>	Customizes each item according to your taste. Photo is displayed in JPEG menu.		
<b>Contrast, Brightness, Color, Tint, Sharpness</b>		Adjusts the color, brightness, etc. for each picture mode to suit your taste		
		<ul style="list-style-type: none"> <li>Display range Contrast/Brightness/Color/Sharpness : 0 - 100</li> <li>Tint : -50 - +50</li> </ul>		
<b>Color temp.</b>	<b>Cool/Normal/Warm</b>	Selects a choice of Cool (blue), Normal, or Warm (red) color.		
<b>C.A.T.S.</b>	<b>Off/On</b>	Automatically adjusts the screen brightness according to the ambient lighting condition.		
<b>Video NR</b>	<b>Off/On</b>	Reduces noise, commonly called snow. Leave it off when receiving a strong signal.		
<b>Color mgmt.</b>	<b>Off/On</b>	On: Enhances green and blue color reproduction, especially outdoor scenes.		
<ul style="list-style-type: none"> <li>Some menus are grayed out depending on the input signal or condition. (e.g. "3:2 pulldown" will be grayed out if the input signal is high-definition or if you are viewing photos, etc.)</li> </ul>				
<b>Advanced picture</b>	<b>3D Y/C filter</b>	<b>Off/On</b>	Minimizes noise and cross-color in the picture.	
	<b>Color matrix</b>	<b>SD/HD</b>	Selects image resolution of component-connected devices. SD: Standard-Definition HD: High-Definition Only used with 480p video signal.	
	<b>Black level</b>	<b>Dark/Light</b>	Selects Dark or Light. Valid only for external input signals.	
	<b>MPEG NR</b>	<b>Off/On</b>	Reduces picture noise in MPEG-compressed video.	
	<b>3:2 pulldown</b>	<b>Off/Auto</b>	Adjusts the picture recorded in 24 fps for optimum quality.	
	<b>Aspect adjustments</b>	<b>Screen format</b>	<b>FULL/4:3/ JUST/ZOOM/</b>	Changes the format (aspect ratio). Lets you choose the aspect depending on the format of received signal.
		<b>H size</b>	<b>Size 1/Size 2</b>	Adjusts the horizontal display range to reduce noise of both side edges of an image. Size 2: Adjusts the image size according to the aspect mode to reduce noise. (p. 27)
		<b>Zoom adjustments</b>	Adjusts vertical alignment and size when aspect setting is "ZOOM".	

**🎵 Audio settings**    Adjust Audio quality

Settings	Items	Item Description
<b>Reset to defaults</b>		Resets Bass, Treble, Balance, Surround, TV speakers, Digital audio out and Audio Input adjustments to factory default settings.
<b>Bass</b>		Increases or decreases the bass response.
<b>Treble</b>		Increases or decreases the treble response.
<b>Balance</b>		Emphasizes the left / right speaker volume.
<b>Surround</b>	<b>Off/On</b>	Enhances audio L/R response when listening to stereo.
<b>TV speakers</b>	<b>On/Off</b>	Switches to "Off" when using external speakers. Off: "Surround" do not work if "Off" is selected.
<b>Digital audio out</b>	<b>Auto/PCM</b>	Auto: Dolby Digital is output as Dolby Digital. DTS is output as DTS. The others are output as PCM. PCM: Digital output signal is fixed to PCM.
<b>Audio Input</b>	<b>HDMI 1-2 In</b>	<b>Digital/AV</b> The default setting is "Digital" for the HDMI connection. (Digital input signal) Select audio input terminal when DVI cable is connected. (Analog audio input signal)

**🔒 Lock**    Locks specified channels or shows to prevent children from watching objectionable content.

You will be asked to enter your password each time you display the Lock menu.  
If it is your first time entering the password, please enter "1234".  
Set "Custom" in "Mode" to specify "Channel", "Program" and "Input" settings.

Settings	Items	Item Description
<b>Mode</b>	<b>Off</b>	Unlocks all the Lock settings of "Channel", "Program" and "Input".
	<b>All</b>	Locks all the inputs regardless of the Lock settings of "Channel", "Program" and "Input".
	<b>Custom</b>	Locks specified inputs of "Channel", "Program" and "Input".
<b>Channel</b> (These channels will be blocked regardless of the program rating.)	<b>Channel</b>	Select a channel to lock.
<b>Program</b> (To set a rating level)	<b>Mode</b>	<b>Off/On</b> Set program lock status. "V-chip" technology enables restricted shows to lock according to TV ratings. On: Set each rating level (U.S.TV Ratings, U.S. Movie Ratings, C.E.L.R., C.F.L.R.)
	<b>U.S.TV Ratings</b>	Select U.S. movie ratings to lock.
	<b>U.S. Movie Ratings</b>	U.S. TV program ratings.
	<b>Canadian English Ratings</b>	For more information (p. 26)
	<b>Canadian French Ratings</b>	
<b>Input</b>	<b>HDMI1-2/AV</b>	Locks external inputs accordingly.
	<b>Change password</b>	Change the password. Input the new 4-digit password twice.

- This television is designed to support the "Downloadable U.S. Region Rating System" when available. (Available only in U.S.A.)
- The Off rating is independent of other ratings.
- When placing a lock on a specific-age-based-rating level, the Off rating and any other more restrictive ratings will also be blocked.

## TV settings Tuning, setting audio mode & language

Settings	Items	Item Description
<b>ANT in</b>	<b>Cable/ Antenna</b>	
<b>Auto program</b>		
<b>Manual program</b>		
<b>MTS</b>	<b>Stereo/SAP/ Mono</b>	Selects the Audio mode for watching TV (p. 16)
<b>Audio Language</b>	<b>English/ Spanish/ French</b>	Selects the language for TV programs
<b>Preferred audio type</b>	<b>Main Audio/ Hearing Impaired/ Visually Impaired</b>	<p>Narration settings for impaired users</p> <p>Hearing Impaired: Activates closed captioning when available on broadcasts.</p> <p>Visual Impaired: Activates the narration sound track when available on broadcasts.</p> <ul style="list-style-type: none"> <li>• For Digital TV only</li> </ul>

## Setup Other function settings

Settings	Items	Item Description
<b>Language</b>	<b>English/Español/ Français</b>	Selects the screen menu language.
<b>Timer set</b>	<b>Sleep Timer</b>	<b>Off/15/30/60/90 (minutes)</b> Sets the period after which the TV will turn off automatically.
	<b>No signal for 10 minutes</b>	<b>Stay on/ Power TV off</b> To conserve energy, the TV automatically turns off when NO SIGNAL and NO OPERATION continue for more than 10 minutes. <ul style="list-style-type: none"> <li>• The on-screen display will flash 3, 2 and 1 to indicate the last three (3) remaining minutes prior to the shut-off.</li> </ul>
	<b>No activity for 3 hours</b>	<b>Stay on/ Power TV off</b> To conserve energy, the TV automatically turns off when no operation of remote and side panel key continues for more than 3 hours. <ul style="list-style-type: none"> <li>• The on-screen display will flash 3, 2 and 1 to indicate the last three (3) remaining minutes prior to the shut-off.</li> </ul>
<b>Anti image retention (Prevent Image retention)</b>	<b>Pixel orbiter (Wobbling)</b>	<b>Off/On</b> Enable: Shifts the display image automatically.
	<b>4:3 side bars (4:3 mode only)</b>	<b>Off/Dark/Mid/ Bright</b> Changes the brightness of the side bar. The recommended setting is "Bright" to prevent the panel "Image retention". (p. 30)
	<b>Scrolling bar</b>	<p>Press "OK" to start the horizontal "Scrolling" on the screen.</p> <ul style="list-style-type: none"> <li>• Press any key except the POWER key to return to previous screen.</li> <li>• You will return to the previous screen if no key operation has been performed for 15 minutes.</li> </ul>





Settings	Items	Item Description
		<ul style="list-style-type: none"> <li>The television includes a built-in decoder that is capable of providing a text display of the audio. The program being viewed must be transmitting the Closed caption (CC) information. (p. 30)</li> <li>The settings in "Analog" or "Digital" depend on the broadcaster.</li> </ul>
<b>Closed Caption</b>	<b>Analog Closed Caption</b>	<b>Off/CC1-4/TEXT1-4</b> Choose the Closed caption service of Analog broadcasting. CC1-4: Information related to pictures (Appears at the bottom of the screen) T1-4: Textual information (Appears over the entire screen)
	<b>Digital Closed Caption</b>	<b>Off/Service1-6</b> The Digital Closed caption menu lets you configure the way you choose to view the digital captioning.
	<b>Digital setting</b> (Set display settings in digital program)	<b>Caption Style: Auto</b> The default settings are displayed. <b>Caption Style: Custom</b> You can personalize below items to your preference: Font Size Font Style Font Color Font Opacity Background Color Background Opacity Outline Color Outline Opacity
<b>Input labels</b>	You can label the terminal with the type of equipment connected to it. This makes selecting input easier (Input select). You can also skip any unused terminal with this feature.	
<b>HDMI control</b>	<b>CEC function</b>	<b>On/Off</b> On: The TV is turned on automatically and switches to the appropriate HDMI input whenever an HDMI connected equipment is initially turned on and the Play mode is selected.
	<b>Power Off Link</b>	<b>Yes/No</b> Yes: When the TV is turned off, all HDMI connected equipment is also automatically turned off. <ul style="list-style-type: none"> <li>A Panasonic DVD Recorder will not turn off if it is still in Rec mode.</li> <li>The TV remains on even if the HDMI connected equipment is turned off.</li> </ul>
<b>About</b>	Displays TV version and software license.	
<b>Reset to defaults</b>	You will be asked to enter your password each time you display the Reset to defaults menu. If it is your first time entering the password, please enter "1234". Performing reset will clear all settings made with Setup, such as channel settings. After reset, "First time setup" will launch when you next power on the TV (p. 15).	

# Technical Information

## Ratings List for parental control

“V-chip” technology enables you to lock channels or shows according to standard ratings set by the entertainment industry.

### ■ U.S. MOVIE RATINGS (MPAA)

NR	Not Rated.
G	All children and General Audience.
PG	Parental Guidance suggested.
PG-13	Parental Guidance for children under 13.
R	Restricted Viewing, parental guidance is suggested for children under 17.
NC-17/X	No one 17 or under allowed.

### ■ U.S. TV PROGRAMS RATINGS (U. S. TV)

#### Age-Based Ratings

TV-NR	Not Rated.
TV-Y	All children.
TV-Y7	Directed to children age 7 and older.
TV-G	General Audience.
TV-PG	Parental Guidance suggested.
TV-14	Parents Strongly cautioned, parental guidance is suggested for children under 14.
TV-MA	Mature Audience only.

#### Contents-Based Ratings

FV	Fantasy Violence.
D	Suggestive Dialogue.
L	Strong Language.
S	Sexual situations.
V	Violence.

### ■ CANADIAN ENGLISH RATINGS (C. E. L. R.)

E	Exempt programming.
C	All children.
C8+	Children 8 years and older.
G	General programming.
PG	Parental Guidance.
14+	Viewers 14 and older.
18+	Adult programming.

### ■ CANADIAN FRENCH RATINGS (C. F. L. R.)

E	Exempt programming.
G	General programming.
8 ans+	Not recommended for young children.
13 ans+	Not recommended for ages under 13.
16 ans+	Not recommended for ages under 16.
18 ans+	Programming restricted to adults.

#### Caution

- The V-Chip system that is used in this set is capable of blocking “NR” programs (non rated, not applicable and none) as per FCC Rules Section 15.120(e)(2). If the option of blocking “NR” programs is chosen “unexpected and possibly confusing results may occur, and you may not receive emergency bulletins or any of the following types of programming:”
  - Emergency Bulletins (Such as EAS messages, weather warnings and others)
  - Locally originated programming • News • Political • Public Service Announcements • Religious • Sports • Weather

## Aspect Ratio (FORMAT)

Press the **FORMAT** button to cycle through the aspect modes. This lets you choose the aspect depending on the format of the received signal and your preference. (p. 17)  
(e.g.: in case of 4:3 image)

- **FULL**: Enlarges the 4:3 image horizontally to the screen's side edges. (Recommended for anamorphic picture)
- **4:3**: Standard (Note that "Image retention" of the side bar may occur from displaying it for a long time.)
- **JUST**: Stretches to justify the 4:3 image to the four corners of the screen. (Recommended for normal TV broadcast)
- **ZOOM**: Enlarges the 4:3 image to the entire screen. (Recommended for Letter Box)
- **H-FILL**: Enlarges the 4:3 image horizontally to the screen's side edges. The side edges of the image are cut off.
- 480i (4:3), 480i (16:9), 480p (4:3), 480p (16:9): FULL, 4:3, JUST or ZOOM
- 1080p / 1080i / 720p: FULL, 4:3, JUST, ZOOM or H-FILL

### ● Zoom adjustments

Vertical image position and size can be adjusted in "ZOOM".

- ① Select "Zoom adjustments" on the "Picture" menu.
- ② V-position: Vertical position adjustment
- ③ V-size: Vertical size adjustment

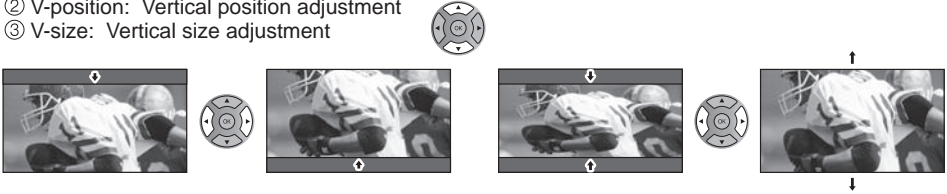

- To reset the aspect ratio →  (OK)

## H size

### ● Aspect Ratio: 4:3

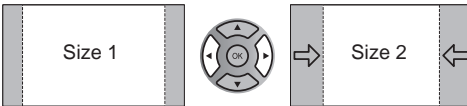

- The width will be decreased on both sides to reduce noise.

### ● Aspect Ratio: FULL/JUST(H-FILL/ZOOM)

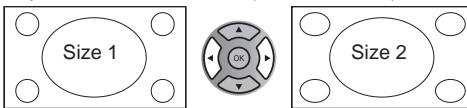

- The width will be increased on both sides to reduce noise.

## Data format information

Compatible Data format for Media player (USB flash memory)

Media	Compatible format
Photo	<ul style="list-style-type: none"> <li>• JPEG files (.jpg) (DCF and EXIF standards) Image resolution 15,360 × 8,640 pixels</li> </ul>
Videos	<ul style="list-style-type: none"> <li>• MP4 files (.mp4/.m4v) Video codec H.264 Audio codec MP3</li> <li>• AVI files (.avi) Video codec H.264 Audio codec MP3/AC3/MPEG1</li> <li>• MKV files (.mkv) Video codec H.264 Audio codec MP3/AC3/MPEG1/DTS Core</li> <li>• FLV files (.flv/.f4v) Video codec H.264 Audio codec MP3</li> <li>• PS files (.mpg/.mpeg) Video codec MPEG1/MPEG2 Audio codec AC3/MPEG1/DVD LPCM</li> <li>• TS files (.ts/.tp/.trp) Video codec H.264/MPEG2 Audio codec MP3/AC3</li> </ul>
Music	<ul style="list-style-type: none"> <li>• MP3 files (.mp3)</li> <li>• MP4 files (.m4a)</li> </ul>

### Note

- The picture may not appear correctly on this TV depending on the recording equipment used.
- Some files may not be played back even if they fulfill these conditions.
- Depending on how you make USB Flash Memory, files and folders may not be displayed in the order you numbered.
- Depending on how you create the files and the structure of folders, the files and folders may not be displayed.
- When there are many files and folders, operation may take time to complete or some files may not be displayed or playable.
- Media player cannot display still images that are not DCF formatted (i.e. TIFF, BMP).
- Modified data with a PC may not be displayed correctly.
- Images imported from a PC must be compatible with EXIF 2.0, 2.1 and 2.2.
- Partly degraded files might be displayed at a reduced resolution.
- All “.JPG” extension data in the USB flash memory will be read in Photo viewer mode.
- The folder and file names may be different depending on the digital camera used.
- Do not use two-byte characters or other special codes.
- The device may become unusable with this TV if file or folder names are changed.

## USB flash memory warning messages

Message	Meaning
No media. Please insert USB storage device.	● The device is not inserted.
No media. Device removed.	● The device is removed.
No photos/No movies/No music/No playable media	● The device has no data or this type of data is not supported.
Video format not supported/Audio format not supported	<ul style="list-style-type: none"> <li>● The file is broken or unreadable.</li> <li>● The TV does not support the format.</li> </ul>

## HDMI connection

HDMI (high-definition multimedia interface) allows you to enjoy high-definition digital images and high-quality sound by connecting the TV unit and HD devices.

HDMI-compatible equipment (\*1) with an HDMI or DVI output terminal, such as a Cable or Satellite box or a DVD player, can be connected to the HDMI connector using an HDMI compliant (fully wired) cable.

- HDMI is the world's first complete digital consumer AV interface complying with a non-compression standard.
  - If the external equipment has only a DVI output, connect to the HDMI terminal via a DVI to HDMI adapter cable (\*2).
  - When the DVI to HDMI adapter cable is used, connect the audio cable to the audio input terminal.
  - Audio settings can be made on the "HDMI 1 in" or "HDMI 2 in" menu screen.  
Applicable audio signal sampling frequencies (L.PCM): 48 kHz, 44.1 kHz, 32 kHz
- (\*1): The HDMI logo is displayed on an HDMI-compliant device.  
(\*2): Enquire at your local digital equipment retailer shop.

### Caution

- The HDMI terminals on this TV were not specifically designed for use with a PC.
- All signals are reformatted before being displayed on the screen.
- If the connected device has an aspect adjustment function, set the aspect ratio to "16:9".
- These HDMI connectors are "type A".
- These HDMI connectors are compatible with HDCP (High-Bandwidth Digital Content Protection) copyright protection.
- A device having no digital output terminal may be connected to the input terminal of either "COMPONENT", or "VIDEO" to receive analog signals.
- The HDMI input terminal can be used with only the following image signals: 480i, 480p, 720p, 1080i, and 1080p.  
Match the output setting of the digital device.
- For details of the applicable HDMI signals, see p. 30.

## DIGITAL AUDIO OUT terminal

You can enjoy your Home theater by connecting a Dolby Digital (5.1 channel) decoder and "Multi Channel" amplifier to the DIGITAL AUDIO OUT terminals.

### Caution

- Depending on your DVD player and DVD-Audio software the copyright protection function may operate and disable optical output.
- When an ATSC channel is selected, the output from the DIGITAL AUDIO OUT jack will be Dolby Digital. When an NTSC channel is selected, the output will be PCM.

## Closed Caption (CC)

- For viewing the CC of digital broadcasting, set the aspect to FULL (If viewing with H-FILL, JUST, ZOOM or 4:3; characters might be cut off).
- The CC can be displayed on the TV only when the receiver (such as a Cable box or satellite receiver) has the CC set to ON within the device itself. Check with your Cable or Satellite provider for instructions. The TV's CC button does not operate the Satellite or Cable box's CC function.
- If the CC is set to On on both the receiver and TV when the signal is 480i (except for the HDMI connection), the CC may overlap on the TV.
- If a digital program is being output in analog format, the CC data will also be output in analog format.
- If the recorder or output monitor is connected to the TV, the CC needs to be set up on the recorder or output monitor.

## 4:3 side bars

Do not display a picture in 4:3 mode for an extended period, as this can cause "Image retention" to remain on either or both sides of the display field.

To reduce the risk of such "Image retention", change the brightness of the side bars.

See page 24 for more information

- The side bar may flash (alternate black/white) depending on the picture.

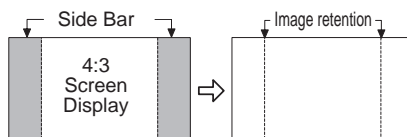

## Input signal that can be displayed

Applicable input signal for Component (Y, P<sub>B</sub>, P<sub>R</sub>), HDMI

	horizontal frequency (kHz)	vertical frequency (Hz)
525 (480)/60i	15.73	59.94
525 (480)/60p	31.47	59.94
750 (720)/60p	45.00	59.94
1,125 (1,080)/60i	33.75	59.94
1,125 (1,080)/60p	67.43	59.94
1,125 (1,080)/60p	67.50	60.00
1,125 (1,080)/24p*	26.97	23.98
1,125 (1,080)/24p*	27.00	24.00

(\* HDMI only)

### Note

- Signals other than those shown above may not be displayed properly.
- The above signals are reformatted for optimal viewing on your display.

Panasonic does not guarantee operation and performance of peripheral devices made by other manufacturers; and we disclaim any liability or damage arising from operation and/or performance from usage of such other maker's peripheral devices.

# Care and Cleaning

**First, unplug the power cord plug from the wall outlet.**

## Display panel

The front of the display panel has been specially treated. Wipe the panel surface gently using only a cleaning cloth or a soft, lint-free cloth.

- If the surface is particularly dirty after cleaning up the dust, soak a soft, lint-free cloth in diluted, mild liquid dish soap (1 part mild liquid dish soap diluted by 100 times the amount of water), and then wring the cloth to remove excess liquid. Use this cloth to wipe the surface of the display panel, then wipe it evenly with a dry cloth of the same type until the surface is dry.
- Do not scratch or hit the surface of the panel with fingernails or other hard objects. Furthermore, avoid contact with volatile substances such as insect sprays, solvents, and thinner; otherwise, the quality of the surface may be adversely affected.

## Cabinet

If the cabinet becomes dirty, wipe it with a soft, dry cloth.

- If the cabinet is particularly dirty, soak the cloth in diluted, mild liquid dish soap and then wring the cloth dry. Use this cloth to wipe the cabinet and then wipe it dry with a dry cloth.
- Do not allow any mild liquid dish soap to come into direct contact with the surface of the Plasma TV. If water droplets get inside the unit, operating problems may result.
- Avoid contact with volatile substances such as insect sprays, solvents, and thinner; otherwise, the quality of the cabinet surface may be adversely affected or the coating may peel off.
- Do not let articles made from rubber or PVC be in contact with the TV for long periods of time.

## Pedestal

Cleaning

- Wipe the surfaces with a soft, dry cloth. If the unit is particularly dirty, clean it using a cloth soaked with water to which a small amount of mild liquid dish soap has been added and then wipe with a dry cloth. Do not use products such as solvents, thinner, or household wax for cleaning, as they can damage the surface coating.  
Note: If using a chemically-treated cloth, follow the instructions supplied with the cloth.
- Do not attach sticky tape or labels, as they can make the surface of the pedestal dirty. Do not allow long-term contact with rubber, vinyl products, or the like. (Doing so will cause deterioration.)

## Power cord plug

Wipe the plug with a dry cloth at regular intervals.

Note: Moisture and dust can lead to fire or electrical shock.

# Frequently Asked Questions (FAQ)

If there is a problem with your TV, please refer to the table below to determine the symptoms, then carry out the suggested check. If this does not solve the problem, visit the Panasonic website for further assistance. (see cover)

Questions	Answers
<p><b>How do I view the picture from devices such as a: Cable/ Satellite box, game console, Blu-ray or DVD player?</b></p>	<ul style="list-style-type: none"> <li>● Press the INPUT button on the remote to select the correct input source.</li> <li>● Check that the device is turned on and functioning correctly.</li> </ul>
<p><b>Why is there no picture or just a blue, black or snowy screen being displayed?</b></p>	<ul style="list-style-type: none"> <li>● Ensure that the power cord is plugged in and the TV is turned on (front red LED light should be on, not blinking).</li> <li>● Press the INPUT button on the remote to select the correct input source.</li> <li>● Ensure all connections are correct and secure. Especially check for Component and VIDEO connection since these terminals are shared.</li> <li>● When using external video source, such as a Cable/Satellite box or DVD player, ensure that the device is on and functioning correctly.</li> <li>● Press MENU on the TV's remote control. If the menu is displayed, then the TV is working; recheck above steps.</li> </ul>
<p><b>Why doesn't the picture look like it is in High-Definition?</b></p>	<ul style="list-style-type: none"> <li>● Press the INFO button on the remote to confirm the type of signal being received (p. 17). HD signal should be 720p, 1080i or 1080p.</li> <li>● Select a High-Definition channel from your HD source (Cable, Satellite or fiber optic service). HD channels sometimes broadcast non-HD content.</li> <li>● Ensure that your HD source (HD box, Blu-ray player, etc.) is connected to the TV with an HDMI or Component cable and set to output an HD video signal.</li> </ul>
<p><b>Why do black bars appear on the top and bottom and/or sides of the screen?</b></p>	<ul style="list-style-type: none"> <li>● Change the format (aspect ratio) of the picture by pressing the FORMAT button on the remote control. (p. 17)</li> <li>● Check the aspect settings on your external video source, such as Cable/Satellite box, DVD/Blu-ray Disc player, etc. Note: Some content, such as film-based movies, are available in extra-wide format. Top and bottom bars are unavoidable.</li> </ul>
<p><b>Why is the picture snowy when "ANT/Cable in" is selected?</b></p>	<ul style="list-style-type: none"> <li>● When using a cable service (without a box), check that all connections are secure.</li> <li>● When using a cable or satellite box, change the connection (wiring) to Composite, Component or HDMI. (p. 12)</li> <li>● If you're using an antenna, then check that connections are secure. Change the position or direction of the antenna and check the "Signal meter". (p. 17)</li> </ul>
<p><b>Why is the picture chaotic and/or torn and/or with a buzz in the speakers?</b></p>	<ul style="list-style-type: none"> <li>● Check if electrical products such as kitchen appliances, fluorescent lights or light dimmers are nearby. They may interfere with the TV's picture.</li> <li>● Try viewing a picture from another device, such as a DVD player or a game console, to narrow down the source of the problem.</li> </ul>
<p><b>Why is there a black box on the screen?</b></p>	<ul style="list-style-type: none"> <li>● Change settings of Closed Caption (CC). (p. 16)</li> </ul>
<p><b>Why is the screen blank and the power indicator blinking?</b></p>	<ul style="list-style-type: none"> <li>● The TV has gone into shutdown mode to protect itself. Try unplugging it for a few minutes and connecting it again. If there was a temporary power surge on the AC line, it may now be OK. If the blinking returns, call 1-877-95-VIERA (U.S.A.) or 1-866-330-0014 (Canada).</li> </ul>

Picture



	Questions	Answers
<b>Picture</b>	<b>Why do some small spots on the screen remain bright or dark?</b>	<ul style="list-style-type: none"> <li>● The Plasma panel is made up of a few million pixels and is produced with advanced technology through an intricate process. Sometimes a few pixels may be bright or dark. These pixels do not indicate a defective panel and will have no impact on the performance of the TV.</li> </ul>
	<b>Why is the picture brightness changing?</b>	<ul style="list-style-type: none"> <li>● Turn the C.A.T.S. feature off. Press MENU -&gt; Picture &gt; C.A.T.S.</li> </ul>
<b>Sound</b>	<b>Why is there no sound coming from the TV?</b>	<ul style="list-style-type: none"> <li>● Make sure the volume is up and MUTE is off.</li> <li>● Confirm the TV speakers are set to ON by pressing MENU and selecting "Audio" --&gt; "TV speakers".</li> <li>● Check that the correct SAP (Secondary Audio Program) is selected by pressing the SAP button on the remote control. (p. 16)</li> <li>● If the TV is connected to a Home Theater via optical cable, then: Check the connection, the audio system is on, the correct input is selected.</li> <li>● Check "HDMI 1 in" or "HDMI 2 in" analog/digital audio settings.</li> </ul>
	<b>Why is the sound unusual, distorted, low volume or in another language?</b>	<ul style="list-style-type: none"> <li>● Check that the correct SAP (Secondary Audio Program) is selected by pressing the SAP button on the remote control.</li> <li>● Check that all connections of external equipment connected to the TV are secure.</li> <li>● When using Cable or Satellite box, check the device's audio settings. (Example: try changing the box's Audio Range to 'narrow')</li> </ul>
	<b>Why is there a clicking, ticking or buzzing sound coming from the TV unit?</b>	<ul style="list-style-type: none"> <li>● When TV power is turned on or shut off, there are electrical components that make a click sound. This is normal operation.</li> <li>● Changes in the temperature and humidity of the room may cause thermal expansion and contraction that can produce sounds. This is not a sign of faulty operation or a malfunction.</li> </ul>
<b>Other</b>	<b>What is the easiest and best way to connect a High-Definition Cable or Satellite box to the TV?</b>	<ul style="list-style-type: none"> <li>● Use an HDMI cable. It carries both digital video and audio signal in HD. HDMI cable is the only cable needed to connect an HD device to the TV.</li> </ul>
	<b>Why does the CC button not display Closed Caption?</b>	<ul style="list-style-type: none"> <li>● When viewing TV via an HDMI connected device, such as a Cable or Satellite box, CC must be enabled at the device.</li> <li>● Closed Caption is available only at supported TV programming.</li> </ul>
	<b>Why does the screen and back cover of the TV get warm?</b>	<ul style="list-style-type: none"> <li>● The main unit radiates heat and some of the parts may become hot. This is normal operation and does not affect the performance of the set.</li> <li>● Ensure good ventilation.</li> <li>● Do not block the ventilation holes of the TV and do not place the TV on top of other equipment.</li> </ul>
	<b>Why doesn't the remote control work?</b>	<ul style="list-style-type: none"> <li>● Check that the batteries are fresh, are of the same type and are installed with the correct polarity (+ &amp; -).</li> <li>● To operate other devices, such as changing channels when using Cable or Satellite boxes, or operating non-Panasonic Blu-ray players, use the remote supplied with the device.</li> </ul>
	<b>Some menu items are grayed-out and unable to be selected. Why?</b>	<ul style="list-style-type: none"> <li>● Depending on certain modes or the selected input, some options are not available. For example, Zoom adjustments are only available when the FORMAT is changed to zoom mode.</li> </ul>
	<b>How do I reset my TV to all factory defaults and settings?</b>	<ul style="list-style-type: none"> <li>● In the main menu, select "Setup". Highlight "Reset to defaults" and press OK. Enter your password (if created earlier) or create a temporary new password. Select Yes to reset the TV.</li> </ul>

# Specifications

		TC-P42X60	TC-P50X60
<b>Power Source</b>		AC 120 V, 60 Hz	
<b>Power Consumption (Rated power / Standby power)</b>		212 W / 0.3 W	265 W / 0.3 W
<b>Display Panel</b>	<b>Panel System</b>	Plasma Display panel	
	<b>Screen size</b>	42" class (41.9 inches measured diagonally)	50" class (49.9 inches measured diagonally)
	<b>W x H x Diagonal</b>	36.5" x 20.5" x 41.9" (929 mm x 522 mm x 1,066 mm)	43.5" x 24.4" x 49.9" (1,106 mm x 622 mm x 1,269 mm)
	<b>Number of pixels</b>	1,024 x 768	
<b>Speaker Output</b>		20 W [10 W + 10 W] (10 % THD)	
<b>Channel Capability (Digital/Analog)</b>		VHF/ UHF: 2 - 69, CATV: 1 - 135	
<b>Operating Conditions</b>		Temperature: 32 °F - 104 °F (0 °C - 40 °C) Humidity: 20 % - 80 % RH (non-condensing)	
<b>Connection Terminals</b>	<b>VIDEO IN</b>	RCA PIN (VIDEO, AUDIO-L, AUDIO-R)	
	<b>COMPONENT IN</b>	RCA PIN (Y, PB, PR, AUDIO-L, AUDIO-R)	
	<b>HDMI IN 1/2</b>	TYPE A Connector	
	<b>USB</b>	USB2.0 Type A connector DC 5V, Max. 500 mA	
	<b>DIGITAL AUDIO OUT</b>	PCM / Dolby Digital, Fiber Optic	
<b>Dimensions</b>	<b>Including pedestal (W x H x D)</b>	39.7" x 25.9" x 9.1" (1,007 mm x 657 mm x 231 mm)	46.6" x 29.8" x 10.5" (1,184 mm x 757 mm x 266 mm)
	<b>TV Set only (W x H x D)</b>	39.7" x 24.3" x 3.2" (1,007 mm x 615 mm x 81 mm)	46.6" x 28.2" x 3.2" (1,184 mm x 716 mm x 81 mm)
<b>Mass</b>	<b>Including pedestal</b>	36.4 lb. (16.5 kg) NET	47.4 lb. (21.5 kg) NET
	<b>TV Set only</b>	34.2 lb. (15.5 kg) NET	45.2 lb. (20.5 kg) NET

## Note

- Design and Specifications are subject to change without notice. Mass and Dimensions shown are approximate.

# Index

<b>A</b>	Accessories .....	8
	Antenna .....	11
	Audio.....	23
	Auto program .....	24
<b>B</b>	Battery .....	8
<b>C</b>	Cable .....	11-12
	Care and Cleaning.....	31
	CC Closed Caption .....	16,30
	Channel .....	16-18
	Colored buttons .....	14
	Component .....	12
	Composite.....	12
	Connections.....	11-12
	Customer Service Directory.....	37
<b>E</b>	Exit.....	14
<b>F</b>	FAQs.....	32-33
	Favorite.....	18
	First Time Setup.....	15
	Format .....	17,27
<b>H</b>	HDMI.....	12,29
	Home Use.....	15
<b>I</b>	Info.....	17
	Input.....	19
	Input labels .....	25
<b>L</b>	language .....	15
	Last.....	14
	Lock .....	23
	Lock / Parental control .....	26
<b>M</b>	Media player .....	20
	Menu.....	21
	Mute.....	14
<b>O</b>	Options menu .....	17
<b>P</b>	Pedestal.....	8-9
	Picture, Advanced.....	22
	Picture settings .....	22
	Power.....	13-14
<b>R</b>	Remote control .....	14
<b>S</b>	Safety.....	4-7
	SAP.....	16
	Specifications.....	34
	Store Demonstration .....	15
<b>T</b>	Technical Information.....	26-30
	TV settings.....	24
<b>U</b>	USB .....	20
<b>W</b>	Warranty .....	36,38
	Watching TV, DVD, Blu-ray, etc. ....	16-19

# Limited Warranty (for U.S.A. and Puerto Rico only)

Panasonic Consumer Marketing Company of North America,  
Division of Panasonic Corporation of North America  
One Panasonic Way  
Secaucus, New Jersey 07094

## Panasonic Television Limited Warranty

### Limited Warranty Coverage

If your product does not work properly because of a defect in materials or workmanship, Panasonic Consumer Marketing Company of North America (referred to as "the warrantor") will, for the length of the period indicated on the chart below, which starts with the date of original purchase ("Limited Warranty period"), at its option either (a) repair your product with new or refurbished parts, (b) replace it with a new or a refurbished equivalent value product, or (c) refund your purchase price. The decision to repair, replace or refund will be made by the warrantor.

TV CATEGORIES	PARTS	LABOR	SERVICE
Up to 42" (diagonal)	1 (ONE) YEAR	1 (ONE) YEAR	Carry-In
46" (diagonal) and larger			On-Site

During the "Labor" Limited Warranty period there will be no charge for labor. During the "Parts" Limited Warranty period, there will be no charge for parts.

You must carry-in your product or arrange for on-site service during the Limited Warranty period. If non-rechargeable batteries are included, they are not warranted. This Limited Warranty only applies to products purchased and serviced in the United States or Puerto Rico. This Limited Warranty is extended only to the original purchaser of a new product which was not sold "as is". A purchase receipt or other proof of the original purchase date is required for Limited Warranty service.

### On-Site or Carry-In Service

For On-Site or Carry-In Service in the United States and Puerto Rico call 1-877-95-VIERA (1-877-958-4372).

On-site service where applicable requires clear, complete and easy access to the product by the authorized servicer and does not include removal or re-installation of an installed product. It is possible that certain on-site repairs will not be completed on-site, but will require that the product or parts of the product, at the servicer's discretion be removed for shop diagnosis and/or repair and then returned.

### Limited Warranty Limits And Exclusions

This Limited Warranty ONLY COVERS failures due to defects in materials or workmanship, and DOES NOT COVER normal wear and tear or cosmetic damage, nor does it cover markings or retained images on the glass panel resulting from viewing fixed images (including, among other things, non-expanded standard 4:3 pictures on wide screen TVs, or onscreen data in a stationary and fixed location such as network logos, video games and banners). The Limited Warranty ALSO DOES NOT COVER damages which occurred in shipment, or failures which are caused by products not supplied by the warrantor, or failures which result from accidents, misuse, abuse, neglect, bug infestation, mishandling, misapplication, alteration, faulty installation, set-up adjustments, misadjustment of consumer controls, improper maintenance, power line surge, lightning damage, modification, or commercial use (such as in a hotel, office, restaurant, or other business), rental use of the product, service by anyone other than a Factory Service Center or other Authorized Servicer, or damage that is attributable to acts of God.

**THERE ARE NO EXPRESS WARRANTIES EXCEPT AS LISTED UNDER "LIMITED WARRANTY COVERAGE". THE WARRANTOR IS NOT LIABLE FOR INCIDENTAL OR CONSEQUENTIAL DAMAGES RESULTING FROM THE USE OF THIS PRODUCT, OR ARISING OUT OF ANY BREACH OF THIS LIMITED WARRANTY.** (As examples, this excludes damages for lost time, cost of having someone remove or re-install an installed unit if applicable, or travel to and from the servicer. The items listed are not exclusive, but are for illustration only.) **ALL EXPRESS AND IMPLIED WARRANTIES, INCLUDING THE LIMITED WARRANTY OF MERCHANTABILITY, ARE LIMITED TO THE PERIOD OF THE LIMITED WARRANTY.**

Some states do not allow the exclusion or limitation of incidental or consequential damages, or limitations on how long an implied Limited Warranty lasts, so the exclusions may not apply to you.

This Limited Warranty gives you specific legal rights and you may also have others rights which vary from state to state. If a problem with this product develops during or after the Limited Warranty period, you may contact your dealer or Service Center. If the problem is not handled to your satisfaction, then write to the warrantor's Consumer Affairs Department at the addresses listed for the warrantor.

**PARTS AND SERVICE (INCLUDING COST OF AN ON-SITE SERVICE CALL, WHERE APPLICABLE) WHICH ARE NOT COVERED BY THIS LIMITED WARRANTY ARE YOUR RESPONSIBILITY.**

# Customer Services Directory (for U.S.A. and Puerto Rico)

## Customer Services Directory (United States and Puerto Rico)

Obtain Product Information and Operating Assistance, locate your nearest Dealer or Service Center, purchase Parts and Accessories, or make Customer Service and Literature requests by visiting our Web Site at:

<http://www.panasonic.com/help>

or, contact us via the web at:

<http://www.panasonic.com/contactinfo>

You may also contact us directly at:

1-877-95-VIERA (958-4372)

Monday-Friday 9 am-9 pm; Saturday-Sunday 10 am-7 pm, EST.

■ For hearing or speech impaired TTY users, TTY: 1-877-833-8855

## Accessory Purchases (United States and Puerto Rico)

Purchase Parts, Accessories and Instruction Books on line for all Panasonic Products by visiting our Web Site at:

<http://www.pstc.panasonic.com>

or, send your request by E-mail to:

[npcparts@us.panasonic.com](mailto:npcparts@us.panasonic.com)

You may also contact us directly at:

1-800-332-5368 (Phone) 1-800-237-9080 (Fax Only) (Monday - Friday 9 am to 9 pm, EST.)

**Panasonic National Parts Center**

20421 84th Avenue South,

Kent, WA 98032

(We Accept Visa, MasterCard, Discover Card, and American Express)

■ For hearing or speech impaired TTY users, TTY: 1-866-605-1277

# Limited Warranty (for Canada)

**Panasonic Canada Inc.**  
5770 Ambler Drive, Mississauga, Ontario L4W 2T3  
**PANASONIC PRODUCT – LIMITED WARRANTY**

Panasonic Canada Inc. warrants this product to be free from defects in material and workmanship under normal use and for a period as stated below from the date of original purchase agrees to, at its option either (a) repair your product with new or refurbished parts, (b) replace it with a new or a refurbished equivalent value product, or (c) refund your purchase price. The decision to repair, replace or refund will be made by Panasonic Canada Inc.

<b>Viera TV (46" &amp; over)</b>	<b>In-home service</b>	<b>One (1) year, parts (including panel) and labour.</b>
<b>Viera TV (under 46")</b>	<b>Carry-in service</b>	<b>One (1) year, parts (including panel) and labour.</b>

In-home Service will be carried out only to locations accessible by roads and within 50 km of an authorized Panasonic service facility.

In-home service requires clear, complete and easy access to the product by the Authorized Servicer and does not include removal or re-installation of an installed product. If removal is required to service the product, it will be at the discretion of the Servicer and in no event will Panasonic Canada Inc. or the Servicer be liable for any special, indirect or consequential damages.

This warranty is given only to the original purchaser, or the person for whom it was purchased as a gift, of a Panasonic brand product mentioned above sold by an authorized Panasonic dealer in Canada and purchased and used in Canada, which product was not sold "as is", and which product was delivered to you in new condition in the original packaging.

## **IN ORDER TO BE ELIGIBLE TO RECEIVE WARRANTY SERVICE HEREUNDER, A PURCHASE RECEIPT OR OTHER PROOF OF DATE OF ORIGINAL PURCHASE, SHOWING AMOUNT PAID AND PLACE OF PURCHASE IS REQUIRED**

### **LIMITATIONS AND EXCLUSIONS**

This warranty ONLY COVERS failures due to defects in materials or workmanship, and DOES NOT COVER normal wear and tear or cosmetic damage. The warranty ALSO DOES NOT COVER damages which occurred in shipment, or failures which are caused by products not supplied by Panasonic Canada Inc., or failures which result from accidents, misuse, abuse, neglect, mishandling, misapplication, alteration, faulty installation, set-up adjustments, misadjustment of consumer controls, improper maintenance, power line surge, lightning damage, modification, introduction of sand, humidity or liquids, commercial use such as hotel, office, restaurant, or other business or rental use of the product, or service by anyone other than a Authorized Servicer, or damage that is attributable to acts of God. Dry cell batteries are also excluded from coverage under this warranty.

THIS EXPRESS, LIMITED WARRANTY IS IN LIEU OF ALL OTHER WARRANTIES, EXPRESS OR IMPLIED, INCLUDING ANY IMPLIED WARRANTIES OF MERCHANTABILITY AND FITNESS FOR A PARTICULAR PURPOSE. IN NO EVENT WILL PANASONIC CANADA INC. BE LIABLE FOR ANY SPECIAL, INDIRECT OR CONSEQUENTIAL DAMAGES RESULTING FROM THE USE OF THIS PRODUCT OR ARISING OUT OF ANY BREACH OF ANY EXPRESS OR IMPLIED WARRANTY. (As examples, this warranty excludes damages for lost time, travel to and from the Authorized Servicer, loss of or damage to media or images, data or other memory or recorded content. This list of items is not exhaustive, but for illustration only.)

In certain instances, some jurisdictions do not allow the exclusion or limitation of incidental or consequential damages, or the exclusion of implied warranties, so the above limitations and exclusions may not be applicable. This warranty gives you specific legal rights and you may have other rights which vary depending on your province or territory.

### **WARRANTY SERVICE**

**For product operation and information assistance, please contact:**

Our Customer Care Centre: 1-800 #: 1-866-330-0014  
or visit our website: <https://conciierge.panasonic.ca>

**For product repairs, please contact Viera Customer Care Agent using the above contact info.**

### **IF YOU SHIP THE PRODUCT TO A SERVICENTRE**

Carefully pack and send prepaid, adequately insured and preferably in the original carton.  
Include details of the defect claimed, and proof of date of original purchase.

.....

.....

.....

.....

.....

.....

.....

.....

.....

.....

.....

.....

.....

.....

.....

.....

.....

.....

.....

.....

.....

.....

.....

.....

● Limited Warranty (for Canada)  
Support Information

USA Only: Disposal may be regulated in your community due to environmental considerations. For disposal or recycling information, please visit Panasonic website:

<http://www.panasonic.com/environmental> or  
call 1-888-769-0149.

Sólo Estados Unidos: La disposición puede estar regulada en su comunidad debido a consideraciones ambientales. Para información sobre la disposición o reciclaje, por favor visite la página web de Panasonic: <http://www.panasonic.com/environmental> o llame al 1-888-769-0149.

#### Customer's Record

The model number and serial number of this product can be found on its back cover. You should note this serial number in the space provided below and retain this book, plus your purchase receipt, as a permanent record of your purchase to aid in identification in the event of theft or loss, and for Warranty Service purposes.

Model Number \_\_\_\_\_

Serial Number \_\_\_\_\_

#### Anotación del cliente

El modelo y el número de serie de este producto se encuentran en su panel posterior. Deberá anotarlos en el espacio provisto a continuación y guardar este manual, más el recibo de su compra, como prueba permanente de su adquisición, para que le sirva de ayuda al identificarlo en el caso de que le sea sustraído o lo pierda, y también para disponer de los servicios que le ofrece la garantía.

Modelo \_\_\_\_\_

Número de serie \_\_\_\_\_

**Panasonic Consumer Marketing Company of North America,  
Division of Panasonic Corporation of North America**  
One Panasonic Way, Secaucus  
New Jersey 07094 U.S.A.

**Panasonic Canada Inc.**  
5770 Ambler Drive  
Mississauga, Ontario  
L4W 2T3 CANADA