

Panasonic®

Operating Instructions
42"/50" Class 720p Plasma HDTV
(41.6/49.9 inches measured diagonally)

Manual de instrucciones
Televisión de alta definición de 720p y clase 42"/50" de Plasma
(41,6/49,9 pulgadas medidas diagonalmente)

Model No. **TC-42PX14**
Número de modelo **TC-50PX14**

Quick Start Guide

(See page 8-18)

Guía de inicio rápido

(vea la página 8-18)



- For assistance (U.S.A./Puerto Rico), please call:
1-877-95-VIERA (958-4372)
or visit us at www.panasonic.com/contactinfo
- For assistance (Canada), please call:
1-866-330-0014
or visit us at www.vieraconcierge.ca
- Para solicitar ayuda (EE.UU./Puerto Rico), llame al:
1-877-95-VIERA (958-4372)
ó visítenos en www.panasonic.com/contactinfo

HDMI™
HIGH-DEFINITION MULTIMEDIA INTERFACE

HDTV

VIERA Link™

**SD
HG**

VIERA™
IMAGE VIEWER

English

Please read these instructions before operating your set and retain them for future reference.
The images shown in this manual are for illustrative purposes only.

Español

Lea estas instrucciones antes de utilizar su televisor y guárdelas para consultarlas en el futuro.
Las imágenes mostradas en este manual tienen solamente fines ilustrativos.

Turn your own living room into a movie theater!
Experience an amazing level of multimedia excitement



<p>HDMI™ <small>HIGH-DEFINITION MULTIMEDIA INTERFACE</small></p> <p>HDMI, the HDMI logo and High-Definition Multimedia Interface are trademarks or registered trademarks of HDMI Licensing LLC.</p>	<p>VIERA Link™</p> <p>VIERA Link™ is a trademark of Panasonic Corporation.</p>	<p>SD HG™</p> <p>SDHC Logo is a trademark.</p>
<p>HDAVI Control™ is a trademark of Panasonic Corporation.</p>	<p>Manufactured under license from Dolby Laboratories. Dolby and the double-D symbol are trademarks of Dolby Laboratories.</p>	<p>HDTV</p>

Contents

Please read before using the unit

- Safety Precautions 4
- Notes 7

Quick Start Guide

- Accessories/Optional Accessory 8
- Basic Connection 11
- Identifying Controls 15
- First Time Setup 16

Enjoy your TV!

Basic Features

- Watching TV 19
- Using VIERA TOOLS 21
- Viewing from an SD Card 22
- Watching Videos and DVDs 24
- Displaying PC Screen on TV 26

Advanced Features

- How to Use Menu Functions (picture, sound quality, etc.) 28
- VIERA Link™ "HDAVI Control™" 32
- Lock 38
- Editing and Setting Channels 40
- Closed Caption 42
- Input Labels 43
- Using Timer 44
- Recommended AV Connections 45

FAQs, etc.

- Ratings List for Lock 46
- Technical Information 47
- Care and Cleaning 51
- FAQ 52
- Specifications 54
- Limited Warranty (for U.S.A. and Puerto Rico only) 55
- Customer Services Directory (for U.S.A. and Puerto Rico) 56
- Limited Warranty (for Canada) 57

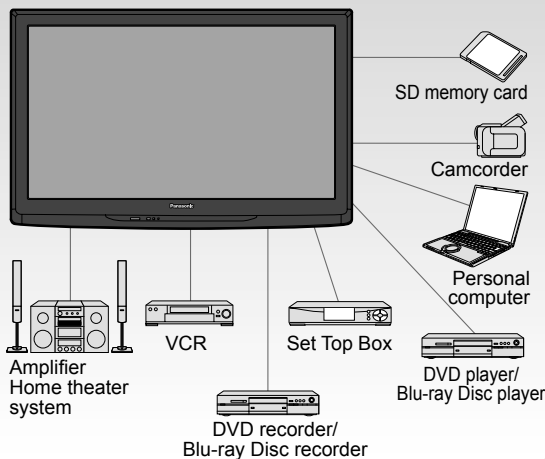

Enjoy rich multimedia



This product qualifies for ENERGY STAR in the "Home use" setting and this is the setting in which energy savings will be achieved. Any modifications to the "Home use" setting or other factory default settings could result in greater energy consumption beyond levels that meet ENERGY STAR qualifications.



Safety Precautions

	CAUTION RISK OF ELECTRIC SHOCK DO NOT OPEN	
WARNING: To reduce the risk of electric shock, do not remove cover or back. No user-serviceable parts inside. Refer servicing to qualified service personnel.		



The lightning flash with arrowhead within a triangle is intended to tell the user that parts inside the product are a risk of electric shock to persons.



The exclamation point within a triangle is intended to tell the user that important operating and servicing instructions are in the papers with the appliance.

WARNING: To reduce the risk of fire or electric shock, do not expose this apparatus to rain or moisture. Do not place liquid containers (flower vase, cups, cosmetics, etc.) above the set (including on shelves above, etc.).

Important Safety Instructions

- 1) Read these instructions.
- 2) Keep these instructions.
- 3) Heed all warnings.
- 4) Follow all instructions.
- 5) Do not use this apparatus near water.
- 6) Clean only with dry cloth.
- 7) Do not block any ventilation openings. Install in accordance with the manufacturer's instructions.
- 8) Do not install near any heat sources such as radiators, heat registers, stoves, or other apparatus (including amplifiers) that produce heat.
- 9) Do not defeat the safety purpose of the polarized or grounding-type plug. A polarized plug has two blades with one wider than the other. A grounding type plug has two blades and a third grounding prong. The wide blade or the third prong are provided for your safety. If the provided plug does not fit into your outlet, consult an electrician for replacement of the obsolete outlet.
- 10) Protect the power cord from being walked on or pinched particularly at plugs, convenience receptacles, and the point where they exit from the apparatus.
- 11) Only use attachments / accessories specified by the manufacturer.
- 12) Use only with the cart, stand, tripod, bracket, or table specified by the manufacturer, or sold with the apparatus. When a cart is used, use caution when moving the cart / apparatus combination to avoid injury from tip-over.
- 13) Unplug this apparatus during lightning storms or when unused for long periods of time.
- 14) Refer all servicing to qualified service personnel. Servicing is required when the apparatus has been damaged in any way, such as power-supply cord or plug is damaged, liquid has been spilled or objects have fallen into the apparatus, the apparatus has been exposed to rain or moisture, does not operate normally, or has been dropped.
- 15) To prevent electric shock, ensure the grounding pin on the AC cord power plug is securely connected.



FCC STATEMENT

This equipment has been tested and found to comply with the limits for a Class B digital device, pursuant to Part 15 of the FCC Rules. These limits are designed to provide reasonable protection against harmful interference in a residential installation. This equipment generates, uses and can radiate radio frequency energy and, if not installed and used in accordance with the instructions, may cause harmful interference to radio communications. However, there is no guarantee that interference will not occur in a particular installation. If this equipment does cause harmful interference to radio or television reception, which can be determined by turning the equipment off and on, the user is encouraged to try to correct the interference by one or more of the following measures:

- Reorient or relocate the receiving antenna.
- Increase the separation between the equipment and receiver.
- Connect the equipment into an outlet on a circuit different from that to which the receiver is connected.
- Consult the dealer or an experienced radio/TV technician for help.

This device complies with Part 15 of the FCC Rules. Operation is subject to the following two conditions: (1) This device may not cause harmful interference, and (2) this device must accept any interference received, including interference that may cause undesired operation.

FCC Caution:

To assure continued compliance, follow the attached installation instructions and use only shielded interface cables when connecting to computer or peripheral devices. Any changes or modifications not expressly approved by Panasonic Corp. of North America could void the user's authority to operate this device.

FCC Declaration of Conformity Model No. TC-42PX14, TC-50PX14

Responsible Party: Panasonic Corporation of North America
One Panasonic Way, Secaucus, NJ 07094
Panasonic Consumer Electronics Company
1-877-95-VIERA (958-4372)
email: consumerproducts@panasonic.com

CANADIAN NOTICE:

For Model TC-42PX14, TC-50PX14
This Class B digital apparatus complies with Canadian ICES-003.

WARNING/CAUTION

WARNING

Small parts can present choking hazard if accidentally swallowed.

Keep small parts away from young children.

Discard unneeded small parts and other objects, including packaging materials and plastic bags/sheets to prevent them from being played with by young children, creating the potential risk of suffocation.

■ Set up

This Plasma TV may fall and can cause personal injury or even death if not installed correctly. To prevent personal injury or death, follow these warnings:

- **Install the Plasma TV in accordance with the manufacturer's recommended pedestal or stand, corresponding hardware and installation instructions.**
This Plasma TV is for use only with the following optional accessories. Use with any other type of optional accessories may cause instability. The following accessories are manufactured by Panasonic Corporation.
 - Wall-hanging bracket (Angled) TY-WK4P1RW
- **Be sure to ask a qualified technician to carry out the installation and set-up.**
Two or more people are required to install or remove the television.
- **Some wall mounts (wall-hanging brackets) are not designed to be mounted to walls with steel studs or old cinder block constructions.**
Ask your dealer or licensed contractor to properly secure the wall-hanging bracket.
- **Do not place the Plasma TV or its stand on a sloped or unstable surface.**
The Plasma TV may fall or tip over.
- **Do not support the Plasma TV on a non-specified pedestal.**
- **Do not place the Plasma TV on furniture that can easily be used as steps, such as a chest of drawers.**
- **Do not climb or allow children to climb on the Plasma TV**
- **Place or install the Plasma TV where it cannot be pushed, pulled over or knocked down.**
- **Route all cords and cables such that they cannot be tripped over or pulled by curious children.**
- **Do not place any objects on top of the Plasma TV.**
If water spills onto the Plasma TV or foreign objects get inside it, a short-circuit may occur which could result in fire or electric shock. If any foreign objects get inside the Plasma TV, please consult an Authorized Service Center.

■ AC Power Supply Cord

To prevent fire or electric shock:

- **The Plasma TV is designed to operate on a 120 V AC, 60 Hz service. Insert the power cord plug as far as it will go into the wall socket.**
If the plug is not fully inserted, heat may generate, which could cause a fire.
- **The included power cord is for use with this unit only.**
- **Do not use any power cord other than that provided with this TV.**
- **Do not handle the power cord plug with wet hands.**
- **Do not do anything that might damage the power supply cord.**

- **When disconnecting the power supply cord, hold the plug, not the cord.**
- **Do not use the power supply cord if the plug or cord is damaged.**
Replace the cord or contact your Authorized Service Center

■ Handling the power supply cord

- **Insert the power plug fully into the socket outlet. (If the power plug is loose, it could generate heat and cause fire.)**
- **Ensure that the power plug is easily accessible.**
- **Ensure the earth pin on the power plug is securely connected to prevent electrical shock.**
 - An apparatus with CLASS I construction shall be connected to a power socket outlet with a protective earthing connection.
- **Do not touch the power plug with a wet hand. (This may cause electrical shock.)**
- **Do not use any power cord other than that provided with this TV. (This may cause fire or electrical shock.)**
- **Do not damage the power cord. (A damaged cord may cause fire or electrical shock.)**
 - Do not move the TV with the cord plugged in the socket outlet.
 - Do not place a heavy object on the cord or place the cord near a high-temperature object.
 - Do not twist the cord, bend it excessively, or stretch it.
 - Do not pull on the cord. Hold onto the power plug body when disconnecting cord.
 - Do not use a damaged power plug or socket outlet.

■ If Problems Occur During Use

- **If a problem occurs (such as no picture or no sound), or if smoke or an abnormal odor is detected from the Plasma TV, unplug the power supply cord immediately.**
Continued use of the TV under these conditions might cause a fire or permanent damage to the TV. Have the TV evaluated by an Authorized Service Center. Servicing of the TV by unauthorized personnel is strongly discouraged due to its high voltage.
- **If water or an object gets inside the Plasma TV, if the Plasma TV is dropped, or if the enclosure becomes damaged, unplug the power supply cord immediately.**
A short-circuit may occur, which could cause a fire. Contact an Authorized Service Center for an evaluation.

CAUTION

- **Do not cover the ventilation holes.**
Doing so may cause the Plasma TV to overheat, which can cause a fire or damage to the Plasma TV.
- **Leave a space of 3 15/16" (10 cm) or more at the top, left and right, and 2 3/4" (7 cm) or more at the rear.**
- **When using the pedestal, keep the space between the bottom of the TV and the pedestal or stand surface clear from objects that may obstruct ventilation.**

■ When Moving the Plasma TV

- **Be sure to disconnect all cables before moving the Plasma TV.**
Moving the TV with its cables attached might damage the cables which, in turn, can cause fire or electric shock
- **To prevent an electric shock, disconnect the power plug from the wall outlet as a safety precaution before carrying out any cleaning.**

Safety Precautions (Continued)

- **Transport only in upright position**

Transporting the unit with its display panel facing upright or downward may cause damage to the internal circuitry.

- **Using a dry cloth, clean any dust from the power supply cord and plug regularly.**

Build-up of dust on the power cord plug can increase humidity, which might damage the insulation and cause a fire.

This Plasma TV radiates infrared rays;

therefore, it may affect other infrared communication equipment. Install your infrared sensor in a place away from direct or reflected light from your Plasma TV.

The TV will still consume some power as long as the power supply cord is connected to the wall outlet.

- **Display panel is made of glass. Do not apply strong force or impact to the display panel.**

This may cause damage resulting in injury.

- **The TV is heavy. TV should be handled by 2 or more people. Support as shown to avoid injury by the TV tipping or falling.**

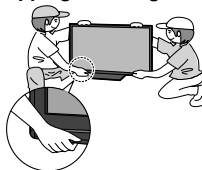

⚠ WARNING

CEA CHILD SAFETY NOTICES: Flat panel displays are not always supported on the proper stands or installed according to the manufacturer's recommendations. Flat panel displays that are inappropriately situated on dressers, bookcases, shelves, desks, speakers, chests or carts may fall over and may cause personal injury or even death.

The consumer electronics industry (of which Panasonic is a member) is committed to making home entertainment enjoyable and safe. To prevent personal injury or death, be sure to follow the following safety guidelines:

TUNE INTO SAFETY:

- One size does NOT fit all. Follow the manufacturer's recommendations for the safe installation and use of your flat panel display.
- Carefully read and understand all enclosed instructions for proper use of this product.
- Don't allow children to climb on or play with furniture and television sets.
- Don't place flat panel displays on furniture that can easily be used as steps, such as a chest of drawers.
- Remember that children can become excited while watching a program, especially on "larger than life" flat panel displays. Care should be taken to install the display where it cannot be pushed, pulled over, or knocked down.
- Care should be taken to route all cords and cables connected to the flat panel display so that they cannot be pulled or grabbed by curious children.

WALL MOUNTING: IF YOU DECIDE TO WALL MOUNT YOUR FLAT PANEL DISPLAY, ALWAYS:

- Use a mount that has been recommended by the display manufacturer and/or listed by an independent laboratory (such as UL, CSA, ETL).
- Follow all instructions supplied by the display and wall mount manufacturers.
- If you have any doubts about your ability to safely install your flat panel display, contact your retailer about professional installation.
- Make sure the wall where you are mounting the display is appropriate. Some wall mounts are not designed to be mounted to walls with steel studs or old cinder block construction. If you are unsure, contact a professional installer.
- A minimum of two people are required for installation. Flat panel displays can be heavy.

Panasonic recommends that a qualified installer perform the wall-mount installation. See page 5.

Notes

■ Do not display a still picture for a long time

This causes the image to remain on the plasma screen

("Image retention"). This is not considered a malfunction and is not covered by the warranty.



To prevent "Image retention", the screen saver is automatically activated after a few minutes if no signals are sent or no operations are performed. (p. 53)

Typical still images

- Channel number and other logos
- Image displayed in 4:3 mode
- SD Card photo
- Video game
- Computer image

■ Set up

- Do not place the unit where it's exposed to sunlight or other bright light (including reflections).
- Use of some types of fluorescent lighting may reduce the remote control's transmission range.

Accessories/Optional Accessory

Accessories

Check you have all the items shown.

Accessories

- Remote Control Transmitter
● N2QAYB000321



- Batteries for the Remote Control Transmitter (2)
● AA Battery



- AC cord

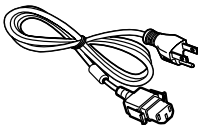

- Pedestal
● TBLX0088 (TC-42PX14)
● TBLX0089 (TC-50PX14)

How to assemble (p. 9)

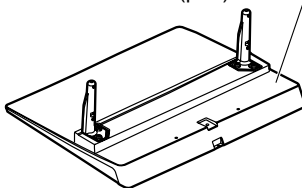

- Cleaning cloth

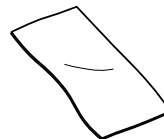

- Operating Instructions

- Product Registration Card (U.S.A.)

- Viera Concierge and basic instruction for HDTV

- Customer Care Plan Card (U.S.A.)

Optional Accessory

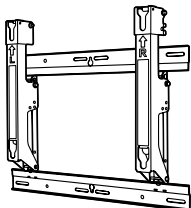

Wall-hanging bracket
(angle)

- TY-WK4P1RW

Note

- In order to maintain the TV's performance and safety, be absolutely sure to ask your dealer or a licensed contractor to secure the wall-hanging brackets.
- Carefully read the instructions accompanying the plasma TV stand or pedestal, and be absolutely sure to take steps to prevent the TV from tipping over.
- Handle the TV carefully during installation since subjecting it to impact or other forces may cause its panel to crack.

Installing the remote's batteries

1

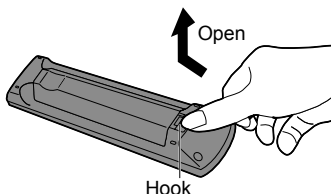

2

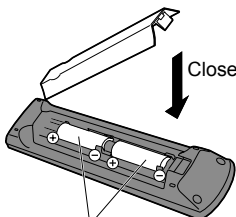

Note the correct polarity (+ or -).

Caution

- Incorrect installation may cause battery leakage and corrosion, resulting in damage to the remote control.
- Do not mix old and new batteries.
- Do not mix different battery types (such as alkaline and manganese batteries).
- Do not use rechargeable (Ni-Cd) batteries.
- Do not burn or break batteries.

Attaching the pedestal to TV

■ Assembling the pedestal

- Fix securely with assembly screws (A). (Total 4 screws)
- Tighten screws firmly.

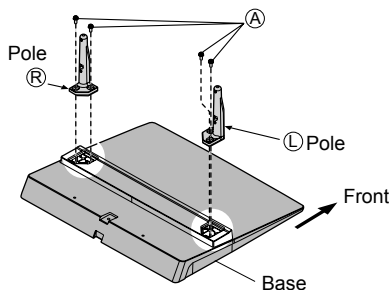

■ Set-up

- Carry out work on a horizontal and level surface.
- Tighten screws firmly.

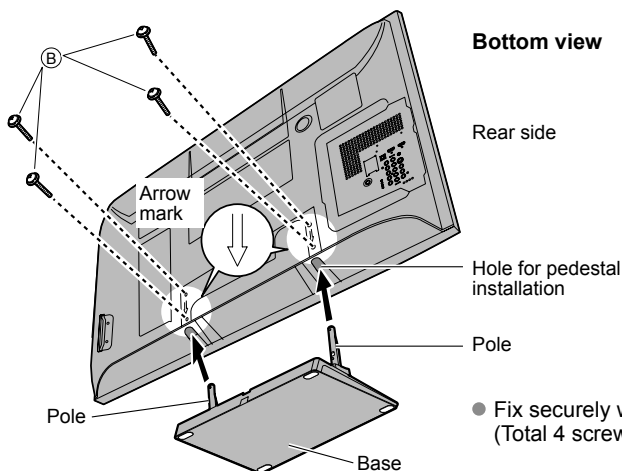

Bottom view

Rear side

Hole for pedestal installation

Pole

- Fix securely with assembly screws (B). (Total 4 screws)

Accessories

Assembly screws
(4 of each)

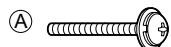

M5 x 18 (Silver)



M5 x 25 (Black)

Poles (2)

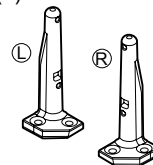

- L or R is printed at the bottom of the poles.

Base (1)

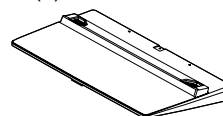

Warning

Do not disassemble or modify the pedestal.

- Otherwise the TV may fall over and become damaged, and personal injury may result.

Caution

Do not use any other TV and displays.

- Otherwise the TV may fall over and become damaged, and personal injury may result.

Do not use the pedestal if it becomes warped or physically damaged.

- If you use the pedestal when it is physically damaged, personal injury may result. Contact your nearest Panasonic Dealer immediately.

During set-up, make sure that all screws are securely tightened.

- If sufficient care is not taken to ensure screws are properly tightened during assembly, the pedestal will not be strong enough to support the TV, and it might fall over and become damaged, and personal injury may result.

Accessories/Optional Accessory (Continued)

AC cord connection

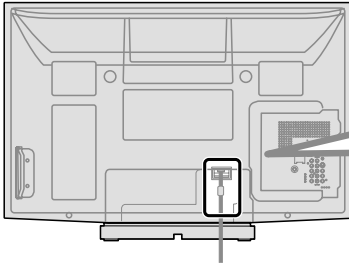

To attach

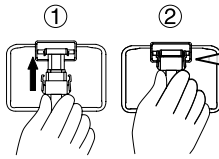

Insert it firmly until the tabs on both sides click into place.

To remove

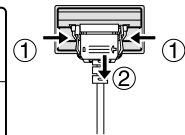

Keep pushing both side snaps and pull down

Reference of connection

Antenna terminal

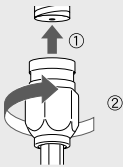

- Firmly tighten by hand.

Pin terminals

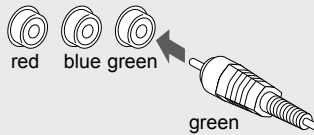

- Match colors of plugs and terminals.
- Insert firmly.

HDMI terminal

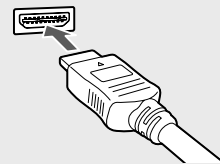

- Insert firmly.

Basic Connection

Example 1 Connecting Antenna (To watch TV)

TV

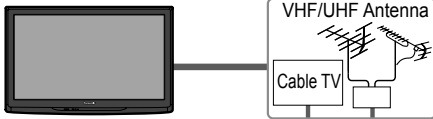

VHF/UHF Antenna

- NTSC (National Television System Committee): Conventional broadcasting
- ATSC (Advanced Television Systems Committee): Digital TV Standards include digital high-definition television (HDTV), standard-definition television (SDTV), data broadcasting, multi-channel surround-sound audio and interactive television.

To connect the antenna terminal and Cable Box

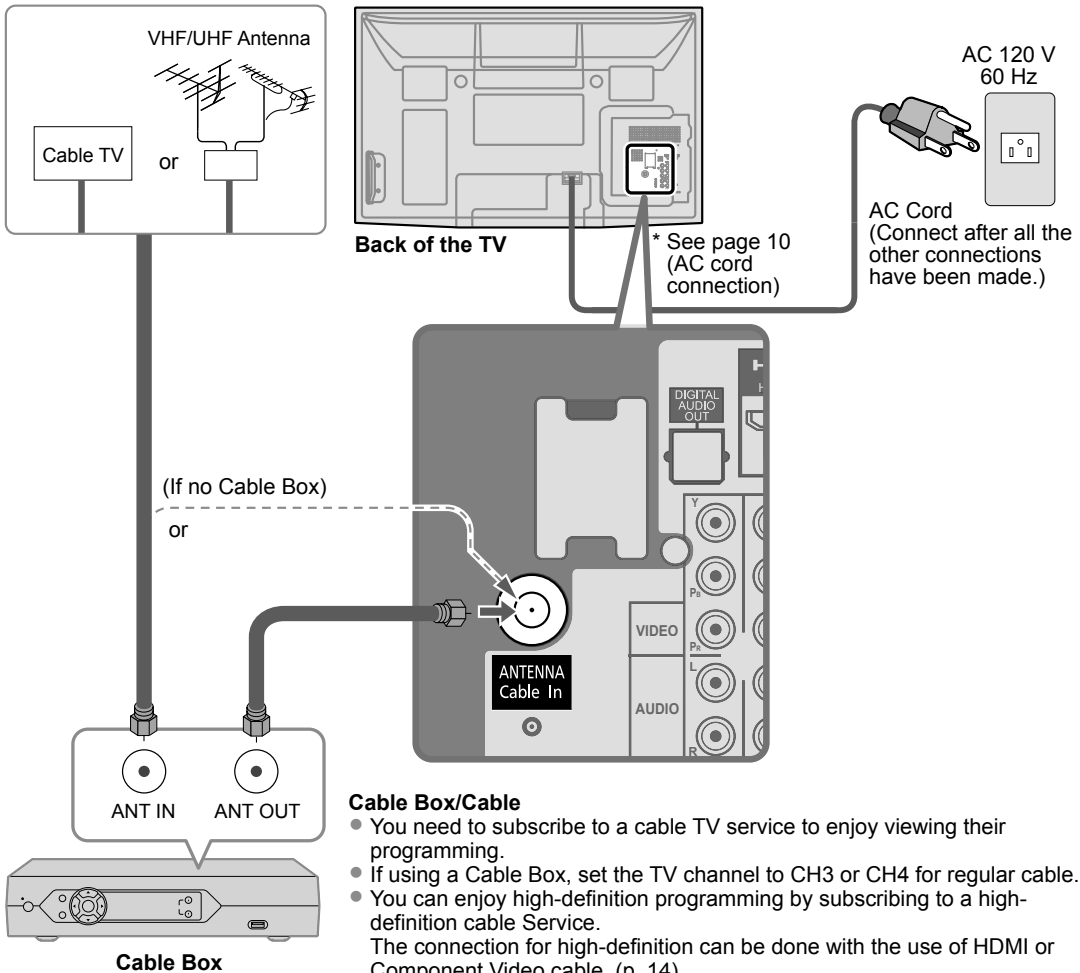

Cable Box/Cable

- You need to subscribe to a cable TV service to enjoy viewing their programming.
- If using a Cable Box, set the TV channel to CH3 or CH4 for regular cable.
- You can enjoy high-definition programming by subscribing to a high-definition cable Service. The connection for high-definition can be done with the use of HDMI or Component Video cable. (p. 14)
- To view high-definition programming select the correct video input. (p. 24)

Note

- Not all cables and external equipment shown in this book are supplied with the TV.
- For more details on the external equipment's connections, please refer to the operating manuals for the equipment.
- When disconnecting the power cord, be absolutely sure to disconnect the power cord plug from the wall outlet first.
- For additional assistance, visit us at: www.panasonic.com
www.panasonic.ca

Basic Connection (Continued)

Example 2 Connecting DVD recorder (VCR) (To record/playback)

TV



AV Equipment
(e.g. DVD Recorder
or VCR)



VHF/UHF Antenna

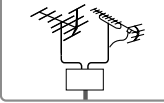

DVD Recorder

If the source has a higher resolution signal (480p/720p/1080i/1080p), connection can be made with the use of a Component Video or HDMI cable. (p. 14)

VCR

Connection can be made with the use of an RF cable and Composite Video/S Video cable. (p. 14)

To connect the antenna terminal and DVD recorder or VCR

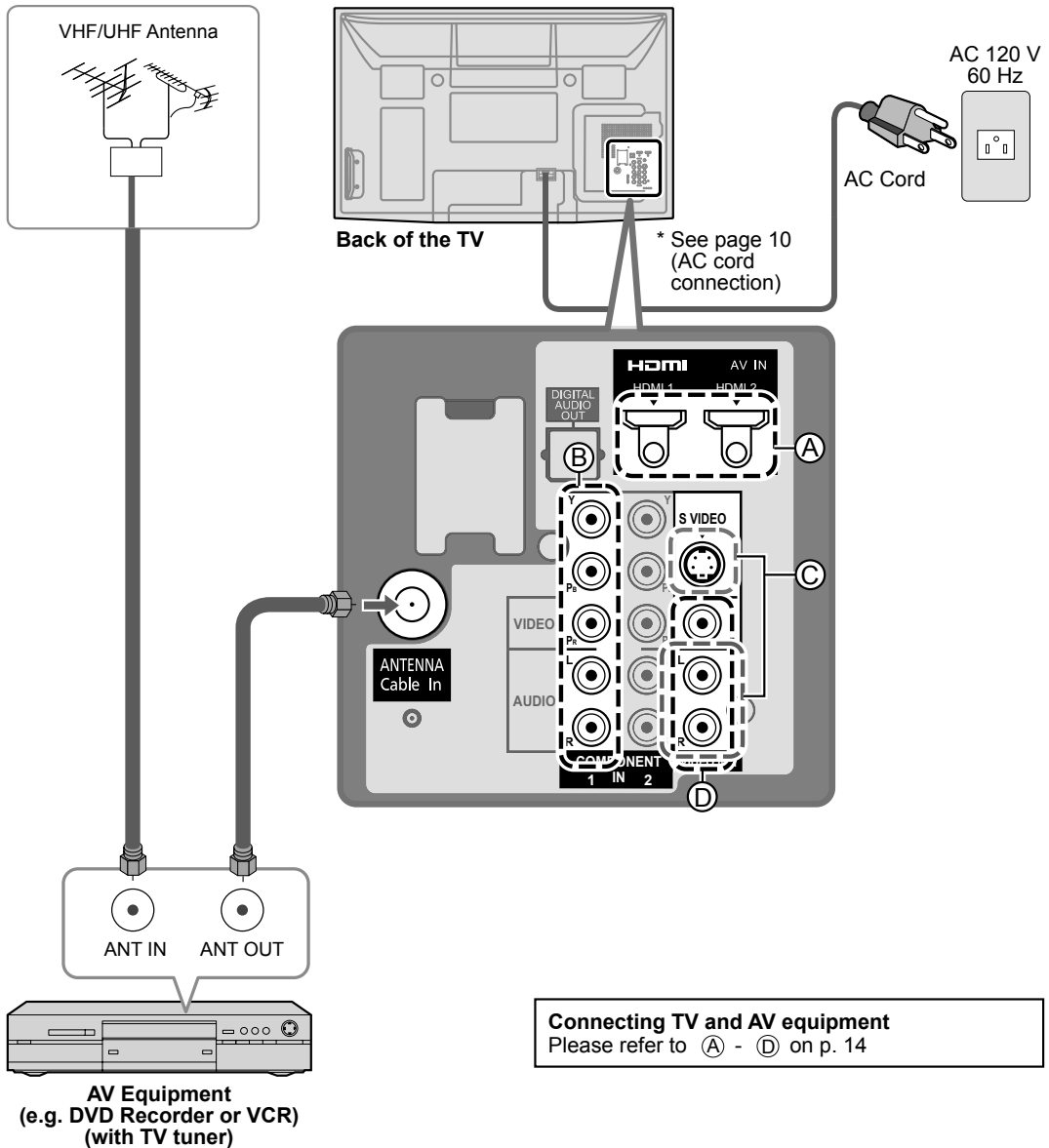

Example 3 Connecting DVD recorder (VCR) and satellite receiver

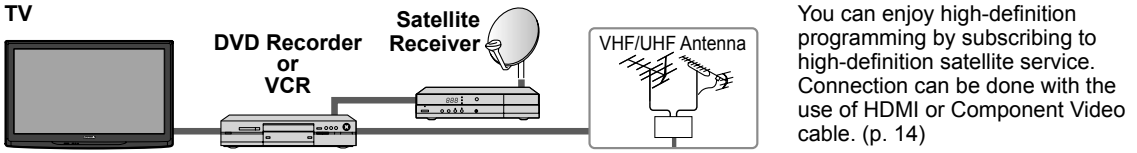

To connect the antenna terminal and Satellite Receiver and DVD recorder or VCR

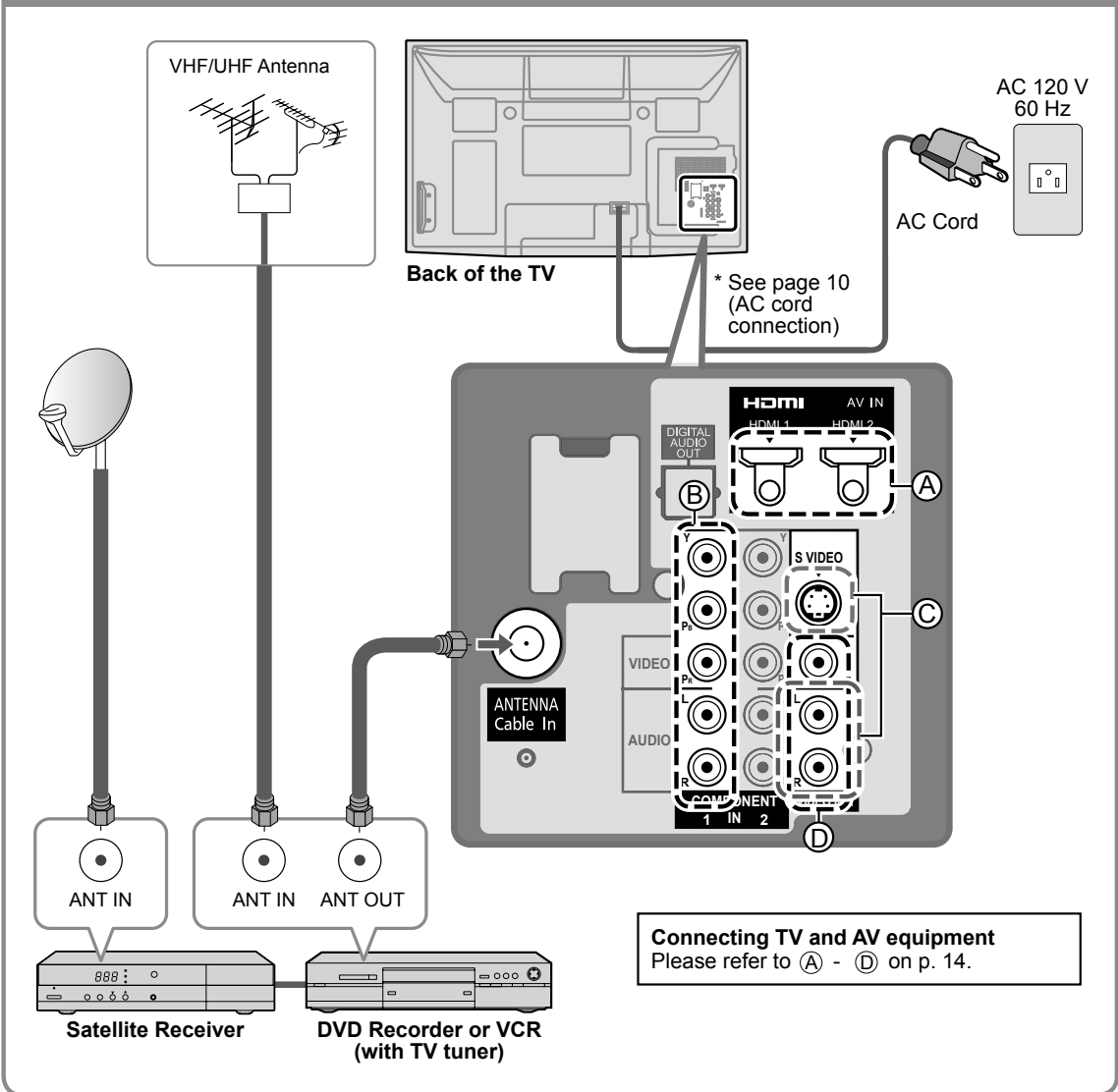

Note

● For details of external equipment connections, please refer to the operating manuals for the equipment.

Basic Connection (Continued)

AV cable connections

A To use HDMI terminals

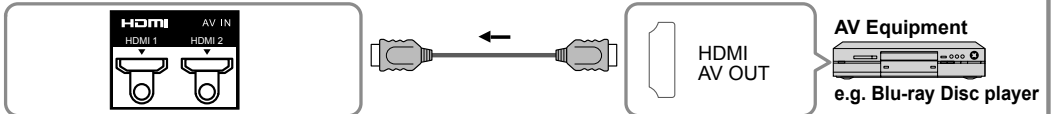

- Connecting to HDMI terminals will enable you to enjoy high-definition digital images and high-quality sound.
- The HDMI connection is required for a 1080p signal.
- For “VIERA Link™ connections”, please refer to p. 33.

B To use COMPONENT terminals

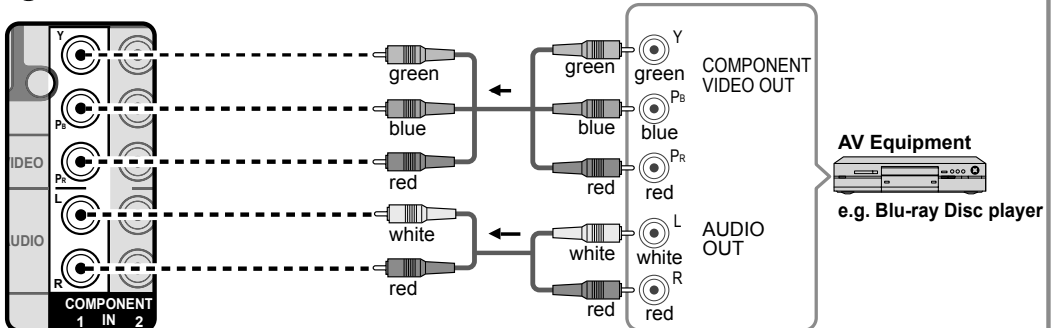

- Recorders may also be connected to COMPOSITE or S VIDEO terminals. (see below)

C To use S VIDEO terminals

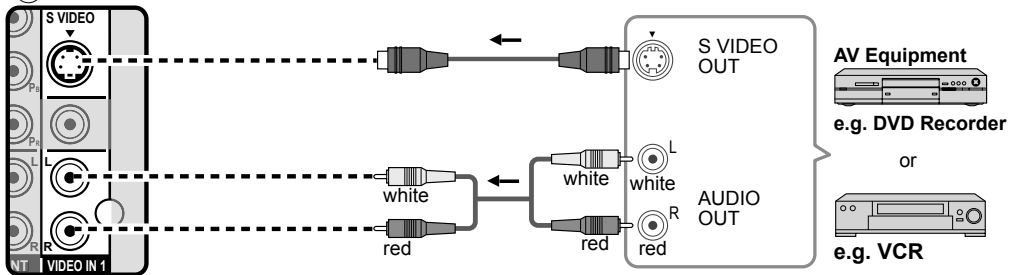

D To use COMPOSITE terminals

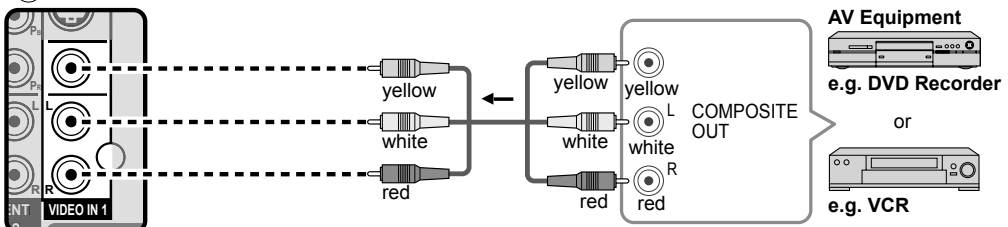

- The S Video input will override the composite video signal when S Video cable is connected. Connect either S Video or Video cable.
- Connecting to S VIDEO terminals will enable you to enjoy greater picture quality than using Composite terminals.

High-Definition

Standard-Definition

Note

- Some programs contain a copyright protection signal to prevent recording.
- When the copyright protection program is displayed, do not connect the other TV monitor through a VCR. Video signals fed through VCRs may be affected by copyright protection systems and the picture will be distorted on the other TV monitor.
- For more details on the external equipment's connections, please refer to the operating manuals for the equipment.

Identifying Controls

TV controls/indicators

Front of the TV

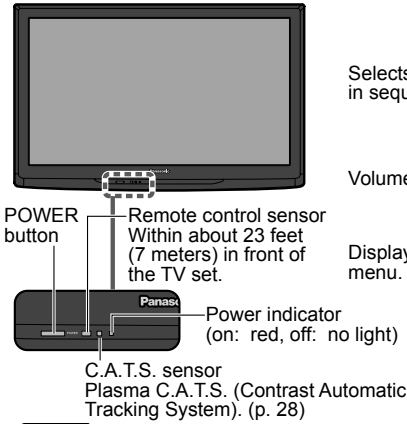

Back of the TV

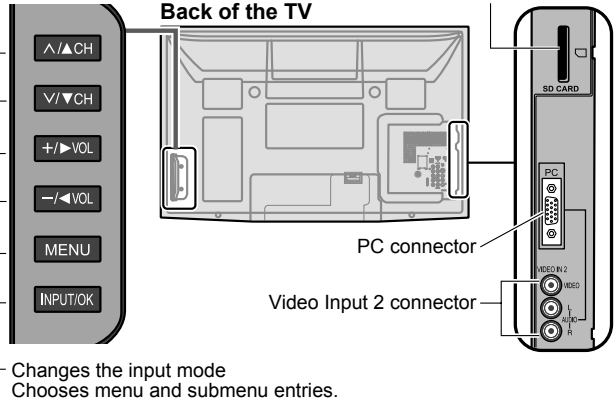

- ^/▲CH
Selects channels in sequence
- V/▼CH
Volume up/down
- + /▶ VOL
-
- ◀ VOL
- MENU
Displays the Main menu.
- INPUT/OK
Changes the input mode
Chooses menu and submenu entries.

Note

- The TV consumes a limited amount of power as long as the power cord is inserted into the wall outlet.
- Do not place any objects between the TV remote control sensor and remote control.

Remote control

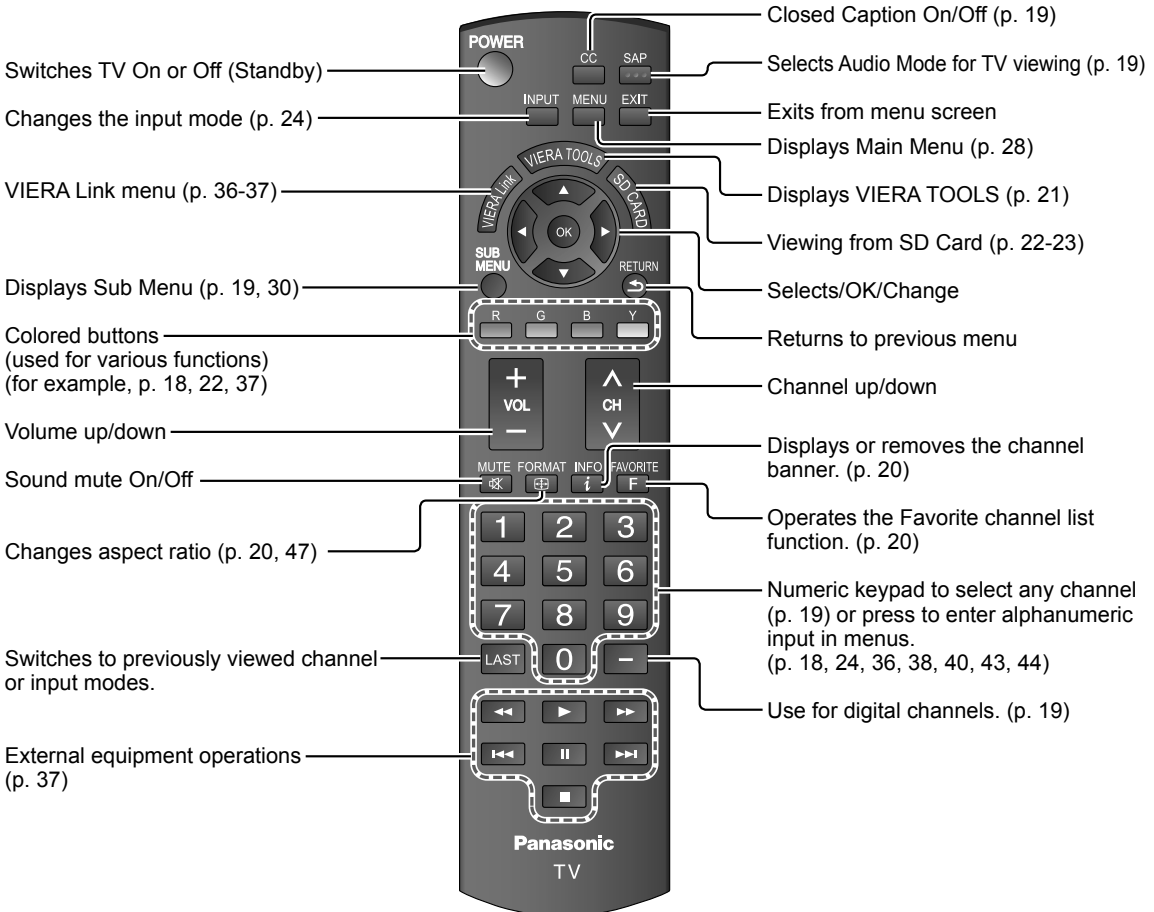

First Time Setup

“First time setup” is displayed only when the TV is turned on for the first time after the power cord is inserted into a wall outlet and when “Auto power on” (p. 30-31) is set to “No”.

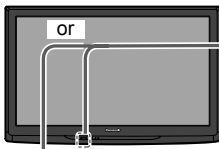

1

Turn the TV On with the POWER button

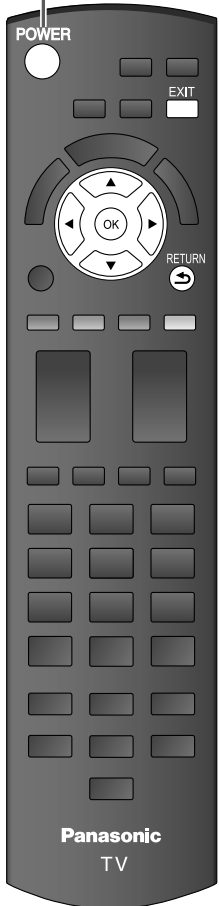
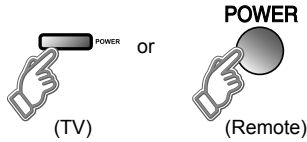

* This setting will be skipped next time if you select “Home Use”.

① Select your language

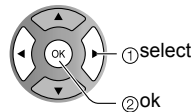

② Be sure to select “Home Use”

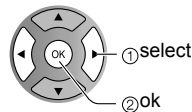
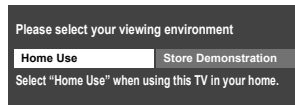

- Please confirm your selection (Home Use) before pressing OK button.

■ If you select “Store Demonstration” by mistake in ②, confirmation screen will be displayed.

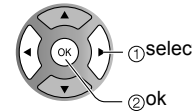
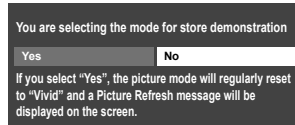

- Select “No” and return to previous screen ②.
- If you select “Yes”, Screen enters store demonstration mode.

To display the “Please select your viewing environment” screen again as shown above and select “Home Use”, do one of the following:

- Press and hold down the front POWER button.
- Unplug the TV and plug it again.

■ Press to exit from a menu screen



■ Press to return to the previous screen



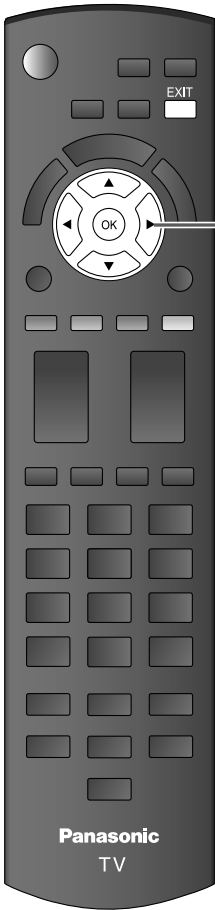

2 Adjust the clock

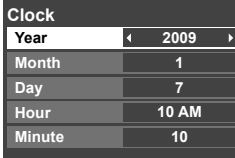
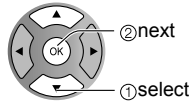
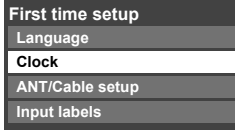

Year: Select the year
 Month: Select the month
 Day: Select the day
 Hour: Adjust the hour
 Minute: Adjust the minute

3 Auto channel setup

① Select "ANT/Cable setup"

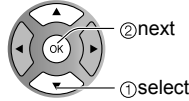
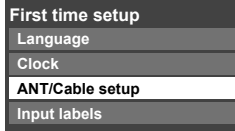

② Select "ANT in"

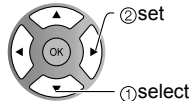
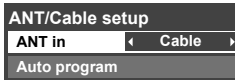

ANT in
 Cable: Cable TV
 Antenna: Antenna
 Not used: Skip TV tuning
 ➔ go to ④

Select "Not used" when no wire is connected to the "Antenna/Cable" terminal.

- Typical when Cable/Satellite box is connected to a TV input.
- Prevents accidental tuning to an unavailable signal.

③ Select "Auto program"

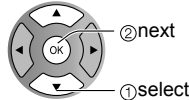
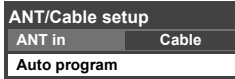

■ Press to exit from a menu screen



Note

- To change setting (Language/Clock/ANT/Cable setup/Input labels) later, go to Menu screen (p. 30)

First Time Setup (continued)

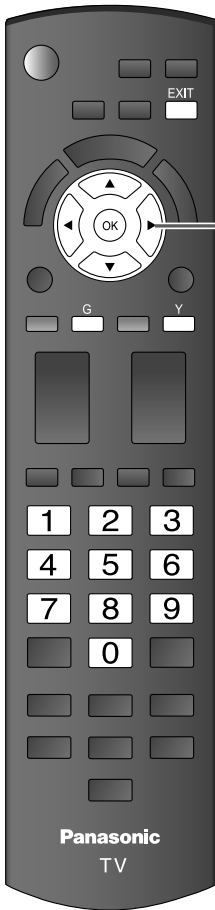

3

4 Select scanning mode (ALL channels/Analog only/Digital only)

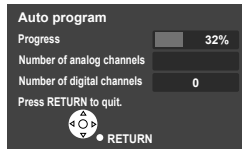
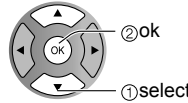
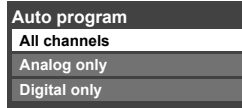

Start scanning the channels

- Available channels (analog/digital) are automatically set.

All channels: Scans digital and analog channels
 Analog only: Scans Analog channels only
 Digital only: Scans Digital channels only

5 Confirm registered channels

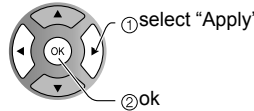
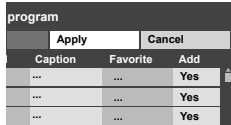

- If OK is not pressed after selecting "Apply", the channels will not be saved. The channel will be saved when no operation is performed for 60 seconds and the "Manual program" menu will also exit automatically.
- If you perform scanning more than twice, previously saved channels are erased.

4

Set the Input labels

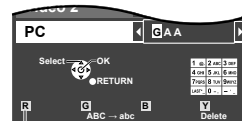
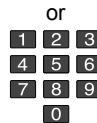
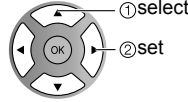
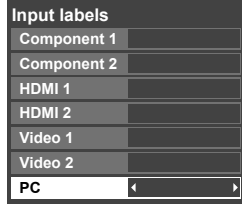
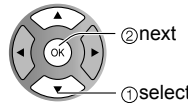
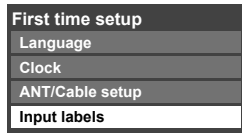

Switches Input mode alphabet to numeric

Press to exit from a menu screen



Note

- About broadcasting systems

Analog (NTSC):

Conventional broadcasting

Digital (ATSC):

New programming that allows you to view more channels featuring high-quality video and sound

Label: [BLANK] SKIP/VCR/DVD/CABLE/SATELLITE/DVR/GAME/AUX/RECEIVER/COMPUTER/Blu-ray/CAMERA/DVD REC/HOME THTR/MONITOR/MEDIA CTR/MEDIA EXT/OTHER

Watching TV

Connect the TV to a cable box/cable, set-top-box, satellite box or antenna cable (p. 11-14)

To watch TV and other functions

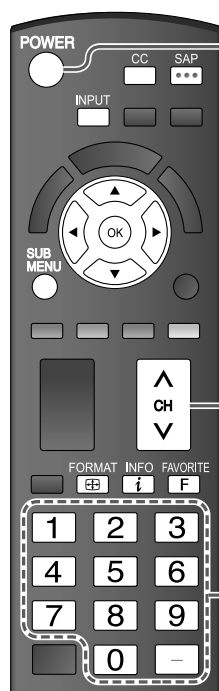

1 Turn power on

POWER

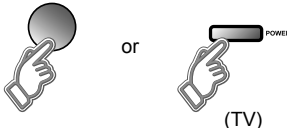

or

(TV)

Note

- If the mode is not TV, press **INPUT** and select TV. (p. 24)

2 Select a channel number

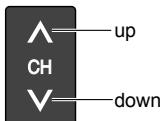

or



(TV)

■ To directly input the digital channel number

When tuning to a digital channel, press the button to enter the minor number in a compound channel number.

example: CH15-1: **1** **5** **-** **1**

Note

- Reselect "Cable" or "Antenna" in "ANT in" of "ANT/Cable setup" to switch the signal reception between cable TV and antenna. (p. 17, 41)
- The channel number and volume level remain the same even after the TV is turned off.

Listen with SAP (Secondary Audio Program)



■ Select Audio Mode for watching TV

- **Digital mode**
Press SAP to select the next audio track (if available) when receiving a digital channel.
Audio track 1 of 2 (English)
- **Analog mode**
Press SAP to select the desired audio mode.
• Each press of SAP will change the audio mode. (Stereo/SAP/Mono)

Closed Caption



■ Switches Closed Caption mode On or Off

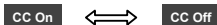

Display the SUB MENU





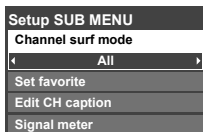

■ Press SUB MENU to show sub menu screen. (p. 30)

This menu consists of shortcuts to convenient functions.

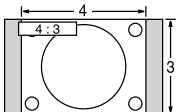

Watching TV (Continued)

Other Useful Functions (Operate after ②)

<p>Information Recall</p>	<p>■ Displays or removes the channel banner.</p>  <table border="1" data-bbox="450 234 1081 347"> <tr> <td>Channel</td> <td colspan="4">THE NEWS</td> <td>Clock</td> </tr> <tr> <td>15-2</td> <td>ABC-HD</td> <td>CC</td> <td>SAP</td> <td>TV-G</td> <td>1080i</td> <td>Standard</td> <td>4:3</td> <td>12:30 PM</td> </tr> <tr> <td>Station identifier</td> <td>Closed caption</td> <td>SAP indication</td> <td>Rating Level</td> <td>Signal resolution</td> <td>Picture mode</td> <td colspan="3">Aspect ratio</td> </tr> <tr> <td colspan="8"></td> <td>Sleep timer remaining time</td> </tr> </table>	Channel	THE NEWS				Clock	15-2	ABC-HD	CC	SAP	TV-G	1080i	Standard	4:3	12:30 PM	Station identifier	Closed caption	SAP indication	Rating Level	Signal resolution	Picture mode	Aspect ratio											Sleep timer remaining time
Channel	THE NEWS				Clock																													
15-2	ABC-HD	CC	SAP	TV-G	1080i	Standard	4:3	12:30 PM																										
Station identifier	Closed caption	SAP indication	Rating Level	Signal resolution	Picture mode	Aspect ratio																												
								Sleep timer remaining time																										
<p>Change aspect ratio</p>	<p>■ Press FORMAT to cycle through the aspect modes. (p. 47)</p>   <ul style="list-style-type: none"> • 480i, 480p: FULL/JUST/4:3/ZOOM • 1080p, 1080i, 720p: FULL/H-FILL/JUST/4:3/ZOOM 																																	
<p>Call up a favorite channel</p>	<p>■ FAVORITE</p>  <p>Channel numbers registered in Favorite are displayed on the favorite tune screen. Select the desired broadcast station with the cursor or use number buttons. (see below)</p>																																	

Favorite Feature

Set Favorite Feature

1 Display the SUB MENU.



2 Select "Set favorite"

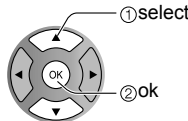
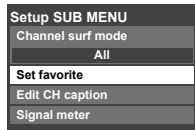

3 Set the displayed channel

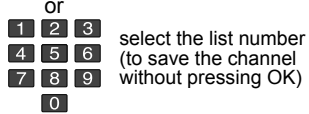
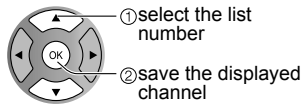
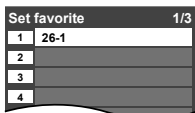

Delete a favorite channel

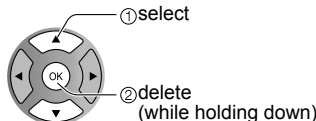
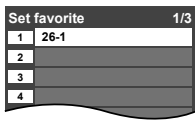

Use Favorite Feature

1 Display "Favorite channels"



2 Select the channel

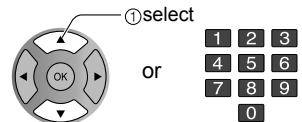
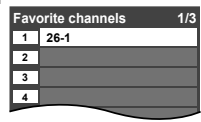

3 Set Favorite channel

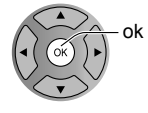
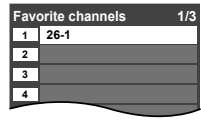

To change the page



Press repeatedly to change between pages(1/3, 2/3, 3/3 or exit)



Changes the page forward/backward

Using VIERA TOOLS

VIERA TOOLS are the easy way to access high use menu items. They are displayed as shortcut icons on the TV screen.





Unlike a conventional menu, you can enjoy using, playing or setting a function quickly.

1 Display VIERA TOOLS



2 Select the item



	Displayed "VIERA Link" menu (p. 36-37)
	Start Slideshow (p. 22-23)
	Set "Sleep"(Off timer) (p. 44)
	Displayed "Lock" menu. (p. 38)

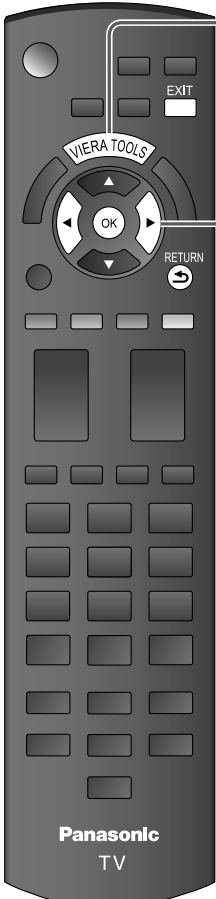

■ Press to exit from a menu screen



■ Press to return to the previous screen



Viewing from an SD Card

You can view photos taken with a digital camera or digital video camera and saved on an SD card.
(Media other than SD Cards may not be reproduced properly.)

Photo viewer

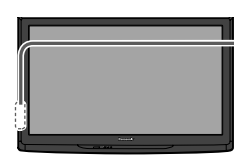

1

Insert the SD card

* This setting will be skipped next time unless you select "Set later".
Set "SD card setting" and select "Play SD card now"

- "SD card setting" will be displayed automatically each time an SD card is inserted for the first time.

SD card setting		
Play SD card automatically	① select	Slideshow: A Slideshow will start automatically next time.
Set later	② change	Thumbnail: The Photo viewer menu will be displayed automatically next time.
Play SD card now	③ set	Set later: "SD card setting" menu will be displayed repeatedly.
		Off: The data can be played manually.

■ **Manual operation** ("Play SD card automatically" is "Off")

Display "Photo viewer"

Start Slideshow

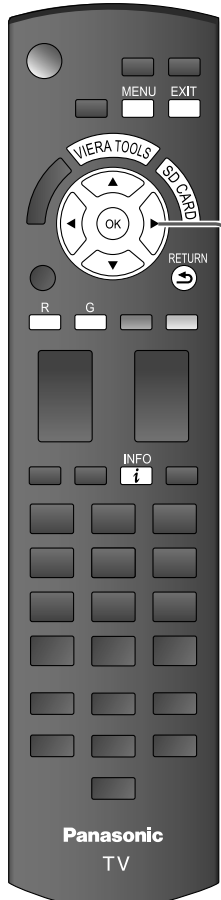

2

Select the data to be viewed

Thumbnail view

Total: 50

Name: Pana0001

Date: 03/04/2009

Size: 1600x1200

Selected picture information is displayed.
Name: Image number or file name is displayed.
Date: Date of recording is displayed.
Size: Display resolution is displayed.

Total number of images

Navigation area

Present status (While reading the data)

To Slideshow

To Single photo play

Note

● Depending on the JPEG format, "Information" contents may not be displayed correctly. Refer to p. 48 (Data format for SD card browsing) for details.

3

View

■ **Press to exit from a menu screen**



■ **Press to return to the previous screen**



- Rotate 90 degrees (counter-clockwise)
- To next photo
- Rotate 90 degrees (clockwise)
- To previous photo

● To display/hide Navigation area →

SD Card

- Insert the card

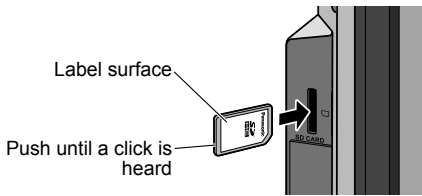

- Remove the card

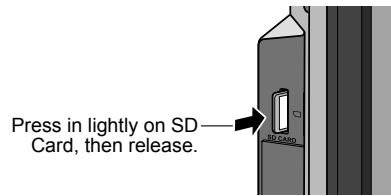

- Compliant card type (maximum capacity): SDHC Card (16 GB), SD Card (2 GB), miniSD Card (1 GB) (requiring miniSD Card adapter)
- For cautions and details on SD Cards (p. 48)

In ② or ③

- ① Display "Photo settings"



- ② Select the item

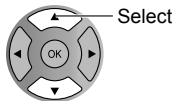
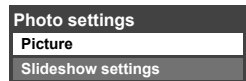

- ③ Set

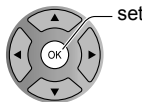

Adjust the picture

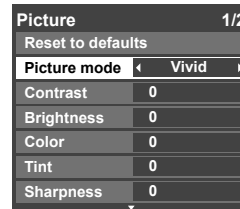

Picture menu (p. 28)

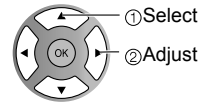
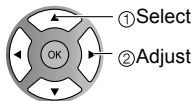
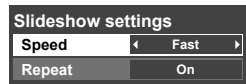

Photo settings

Set up Slideshow



Speed

You can set how many seconds each image is displayed in Slideshow mode.
(Very fast/Fast/Medium/Slow/Very slow)

Repeat

Turn the slideshow Repeat function On or Off.

Note

- To stop in mid-cycle ➔ Press **RETURN**

Viewing

- Viewing from SD Card

VIERA IMAGE VIEWER

The VIERA Image Viewer is a function that lets you easily view still and motion images on a VIERA television by simply inserting an SD card into the VIERA SD card slot.

Watching Videos and DVDs

If you have applicable equipment connected to the TV, you can watch videos and DVDs on the TV's screen.

Input Select

You can select the external equipment to access.

1 With the connected equipment turned On **Display the Input select menu**



2 **Select the input mode**

Input select	
1	TV
2	Component 1 AUX
3	Component 2
4	HDMI 1
5	HDMI 2
6	Video 1
7	Video 2
8	PC

(example)

Press corresponding NUMBER button on the remote control to select the input of your choice.

or

Select the input of your choice, then press OK.

- During the selection, if no action is taken for several seconds, the "Input select" menu disappears.
- The terminal and label of the connected equipment are displayed. To label each of the inputs, please refer to p. 43.

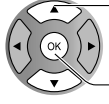

3 **Operate the connected equipment using the remote control supplied with the equipment**

Note

- The input label will be displayed on "Input select" screen if Input label is set on p. 43.
- For more details for Input label, refer to p. 43.

Note

- For details, see the manual of the connected equipment.

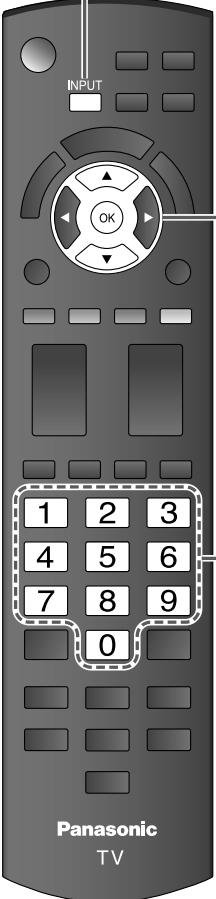

Terminal Label

Label

(example)

■ To return to TV



VIERA Link™ Setting

If you connect equipment that has the “HDAVI Control” function to a TV using an HDMI cable, you will find it easier to use. Please refer to p. 32-37. Before using these functions, you need to set “VIERA Link” setting to “On” as shown below.

1 Display menu
MENU

2 Select “Setup”
Menu
VIERA Link
Lock
SD card
Closed Caption
Setup

3 Select “VIERA Link settings”
Setup 2/2
VIERA Link settings
ECO/power saving
Advanced setup

4 Select “VIERA Link”
VIERA Link settings
VIERA Link On
Power on link Yes
Power off link Yes
Stand-by power save No
Auto power stand-by No
Default speakers TV

5 Select “On”
(default is On)

Now you can set each “VIERA Link” function according to your preference (p. 34-37).

■ Press to exit from a menu screen
EXIT

■ Press to return to the previous screen
RETURN

Note

- If no HDMI equipment is connected or standard HDMI equipment (non- “VIERA Link”) is used, set it to “Off”.
- For more details on the external equipment’s connections, please refer to the operating manuals for the equipment.

Viewing

● Watching Videos and DVDs

Displaying PC Screen on TV

The screen of the PC connected to the unit can be displayed on the TV.

You can also listen to PC sound with the audio cable connected. To connect PC (p. 45)

1 Display the Input select menu

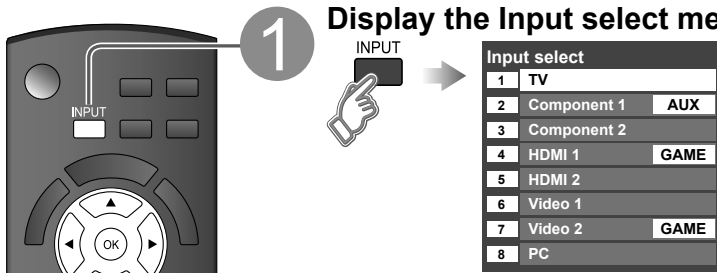

Input select	
1	TV
2	Component 1 AUX
3	Component 2
4	HDMI 1 GAME
5	HDMI 2
6	Video 1
7	Video 2 GAME
8	PC

2 Select "PC"

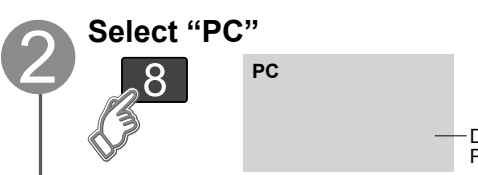

PC

Displays PC screen

● Corresponding signals (p. 50)

To return to TV INPUT → 1 /

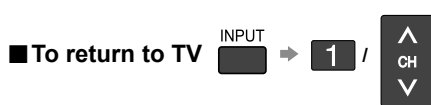

■ **PC menu setting** (change as desired)

- Making settings ➔ "How to Use Menu Functions" ① to ④ (p. 28)

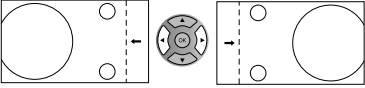
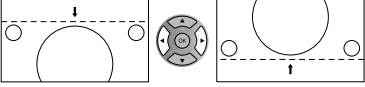
Menu	Item	Adjustments/Configurations (options)
Picture	Reset to defaults	Resets PC adjust
	Sync	<ul style="list-style-type: none"> ● H & V: The H and V sync signals are input from the HD/VD connector. (p. 51) ● On green: Uses a synchronized signal on the Video G signal, which is input from the G connector. (p. 51)
	Dot clock	Alleviates the problem if a picture appears to be vertically-striped, flickers partially or is blurred.
	H-position	Adjusts the horizontal position. 
	V-position	Adjusts the vertical position. 
	Clock phase	<p>Alleviates the problem if the whole picture appears to flicker or is blurred. First adjust the Dot Clock to get the best possible picture, then adjust the Clock Phase so that a clear picture appears.</p> <p>Note</p> <p>It may not be possible to display a clear picture due to poor input signals.</p>
	Input resolution	<p>Switches to wide display.</p> <ul style="list-style-type: none"> ● Input signal switched from 640×480 to 852×480 ● Input signal switched from 1024×768 to 1280×768 or 1366×768
	H-frequency V-frequency	<p>Displays the H (Horizontal)/V (Vertical) frequencies.</p> <ul style="list-style-type: none"> ● Display range Horizontal: 15 - 110 kHz Vertical: 48 - 120 Hz

- Audio menu (p. 28)

Viewing

- Displaying PC Screen on TV

How to Use Menu Functions

Various menus allow you to make settings for the picture, sound, and other functions so that you can enjoy watching TV best suited for you.

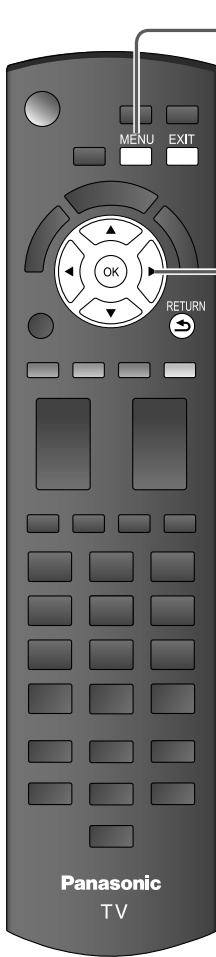

1 Display menu



- Displays the functions that can be set (varies depending on the input signal)

2 Select the menu

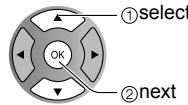
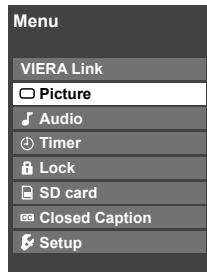

3 Select the item

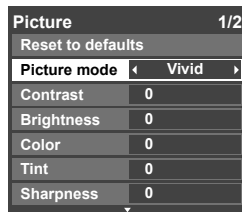

(example: Picture menu)

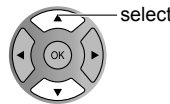

4 Adjust or select

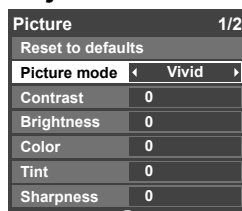

(example: Picture menu)

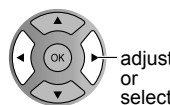

■ Press to exit from a menu screen



■ Press to return to the previous screen



Menu list

Menu	Item	
VIERA Link	VIERA Link control	
	Speaker output	
Picture	Reset to defaults	
	Picture mode	
	Contrast, Brightness, Color, Tint, Sharpness	
	Color temp.	
	C.A.T.S.	
	Video NR	
	Zoom adjustments	
	PC adjustments	
	Advanced picture	3D Y/C filter
		Color matrix
MPEG NR		
Black level		
H size		
Audio	Reset to defaults	
	Bass	
	Treble	
	Balance	
	Advanced audio	Surround
		Volume leveler
		TV speakers
	HDMI 1 in HDMI 2 in	
Timer	Sleep, Timer 1-5	
Lock		
SD card	SD card	
Closed Caption	Closed Caption	

Adjustments/Configurations (alternatives)

[VIERA Link control]

Selects equipment to access and operate. **(Recorder/Home theater/Player/Camcorder/LUMIX)** (p. 36-37)

[Speaker output]

Selects an audio output. **(Home theater/TV)** (p. 36-37)

- VIERA Link menu is accessible directly by pressing the VIERA Link button on the remote control.  (p. 36)

Resets all picture adjustments to factory default settings except for "Advanced picture".

Reset to defaults

Basic picture mode **(Vivid/Standard/Cinema/Custom)** (p. 49)

Picture mode **Vivid**

Adjusts color, brightness, etc. for each picture mode to suit your taste

- Display range

Contrast/Brightness/Color/Sharpness: 0 - 100

Tint: -50 - +50

Contrast **+20**

Tint **0**

Brightness **0**

Sharpness **0**

Color **0**

Selects a choice of Cool(blue), Normal, or Warm(red) color. **(Cool/Normal/Warm)**

Color temp. **Cool**

Adjusts the brightness and gradation according to the ambient lighting condition. **(Off/On)**

C.A.T.S. **Off**

Reduces noise, commonly called snow. Leave it off when receiving a strong signal. **(Off/On)**

Video NR **Off**

Adjusts vertical alignment and size when aspect setting is "ZOOM" (p. 47)

Zoom adjustments

Sets PC display (p. 26)

PC adjustments

Minimizes noise and cross-color in the picture. **(On/Off)**

3D Y/C filter **On**

Selects image resolution of component-connected devices **(HD/SD)**

- SD: Standard Definition HD: High Definition

- Only 480p signal accepted; regular TV (NTSC) is not available.

Color matrix **SD**

Reduces noise of specific digital signals of DVD, STB, etc. **(On/Off)**

MPEG NR **Off**

Selects Dark or Light. Valid only for external input signals. **(Dark/Light)**

Black level **Light**

Adjust horizontal display range to reduce noise of both side edges of an image. **(Size 1/Size 2)**
Size 2: Adjust image size according to aspect mode for reducing noise. (p. 50)

H size **Size 1**

Resets Bass, Treble and Balance adjustments to factory default settings.

Reset to defaults

Increases or decreases the bass response.

Bass **0**

Increases or decreases the treble response.

Treble **0**

Emphasizes the left / right speaker volume.

Balance **0**

Enhances audio response when listening to stereo. **(On/Off)**

Surround **Off**

Minimizes volume disparity after switching to external inputs.

Volume leveler **0**

Switch to "Off" when using external speakers **(On/Off)**

- "Surround" and "Volume leveler" do not work if "Off" is selected.

TV speakers **On**

The default setting is "Digital" for HDMI connection. (Digital input signal)
Select audio input terminal when DVI cable is connected. (Analog audio input signal)
(Digital/Component 1/Component 2/Video 1/Video 2)

HDMI1 in **Digital**

HDMI2 in **Digital**

The TV can automatically turn On/Off at the designated date and time (p. 44)

Locks the channels and programs (p. 38)

Displays SD card data (p. 22-23)

SD card

Displays subtitles (Closed Caption) (p. 42)

Closed Caption

- In AV mode, the Audio menu and Setup menu give fewer options.

How to Use Menu Functions

Various menus allow you to make settings for the picture, sound, and other functions so that you can enjoy watching TV best suited for you.

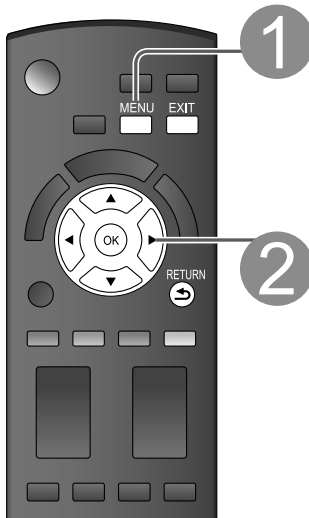

1 Display menu



- Displays the functions that can be set (varies depending on the input signal)

2

Select "Setup"

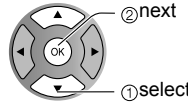
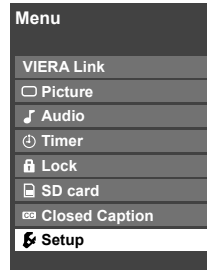

- Press to exit from a menu screen



- Press to return to the previous screen



3

Select the item

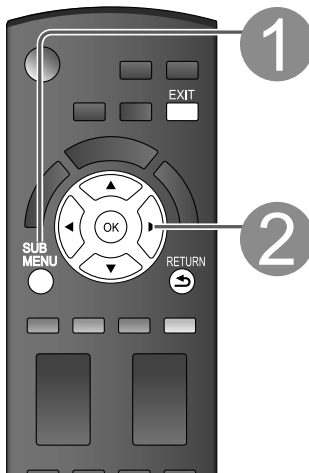
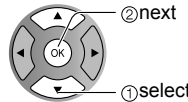
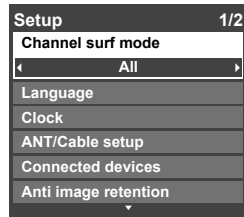

1 Display Sub Menu

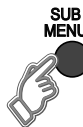

2

Select the item

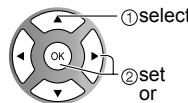
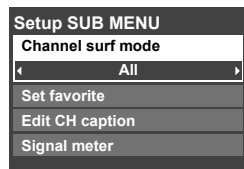

Menu list

Menu	Item		
Setup	Channel surf mode		
	Language		
	Clock		
	ANT/Cable setup		
	Connected devices	Input labels	
	Anti image retention	Pixel orbiter	
		Time (minutes)	
		4:3 side bars	
		Scrolling bar	
	VIERA Link settings	VIERA Link	
Power on link			
Power off link			
Stand-by power save			
Auto power stand-by			
ECO/power saving	Default speakers		
	No signal for 10 minutes		
Advanced setup	No activity for 3 hours		
	Auto power on		
About	Play SD card automatically		
	Reset to defaults		

Sub menu list

Menu	Item	
Setup SUB MENU	Channel surf mode	
	Set favorite	
	Edit CH caption	
	Signal meter	

(Continued)

Adjustments/Configurations (alternatives)

<p>Sets the mode to select the channel with Channel up/down button (All/Favorite/Digital only/Analog only)</p> <ul style="list-style-type: none"> Favorite: Only channels registered as FAVORITE (p. 20) 	<p>Channel surf mode</p> <p>All</p>
<p>Selects the screen menu language (p. 16)</p>	<p>Language</p>
<p>Adjusts the clock (p. 17)</p>	<p>Clock</p>
<p>Sets channels (p. 41)</p>	<p>ANT/Cable setup</p>
<p>Selects the terminal and label of the external equipment (p. 43)</p>	
<p>Prevents "Image retention" with Wobbling. (Automatic/Periodic)</p> <ul style="list-style-type: none"> Automatic: Shifts the display image automatically. Periodic: Shifts the display image every (1/2/3/4) minutes according to what was set in the "Time (minutes)" menu. 	<p>Pixel orbiter</p> <p>Automatic</p>
<p>Sets the time for "Pixel orbiter-Periodic" setting. (1/2/3/4)</p>	<p>Time (minutes)</p> <p>4</p>
<p>Change the brightness of the side bar (Off/Dark/Mid/Bright) (4:3 mode only)</p> <ul style="list-style-type: none"> The recommended setting is "Bright" to prevent panel "Image retention". (p. 50) 	<p>4:3 side bars</p> <p>Bright</p>
<p>Press "OK" to start horizontal "Scrolling" on the screen (p. 50)</p>	<p>Scrolling bar</p>
<p>Controls equipment connected to HDMI terminals (p. 34) (On/Off)</p> <ul style="list-style-type: none"> "Power off link", "Power on link", "Stand-by power save", "Auto power stand-by", and "Default speakers" cannot be selected if "Off" is set. 	<p>VIERA Link</p> <p>On</p>
<p>Sets "Power on link" of HDMI connection equipment (p. 34) (Yes/No)</p>	<p>Power on link</p> <p>Yes</p>
<p>Sets "Power off link" of HDMI connection equipment (p. 34) (Yes/No)</p>	<p>Power off link</p> <p>Yes</p>
<p>Set "Stand-by power save" of HDMI connection equipment. (p. 34) (No/Yes)</p>	<p>Stand-by power save</p> <p>No</p>
<p>Set "Auto power stand-by" of HDMI connection equipment. (p. 34) (No/Yes (with reminder)/Yes (no reminder)</p>	<p>Auto power stand-by</p> <p>No</p>
<p>Selects the default speakers (p. 34) (TV/Theater)</p>	<p>Default speakers</p> <p>TV</p>
<p>To conserve energy, the TV automatically turns off when NO SIGNAL and NO OPERATION is performed for more than 10 minutes. (Enable/Disable)</p> <p>Note</p> <ul style="list-style-type: none"> Not in use when setting "Auto power on", "On/Off Timer", "Lock", "SD mode" or Digital channel. "No signal for 10 minutes was activated" will be displayed for about 10 seconds when the TV is turned on for the first time after turning the power off by "No signal for 10 minutes". The on-screen display will flash 3, 2 and 1 to indicate the last three (3) remaining minutes prior to the shut-off. 	<p>No signal for 10 minutes</p> <p>Enable</p>
<p>To conserve energy, the TV automatically turns off when no operation of remote or side panel key continues for more than 3 hours. (Enable/Disable)</p> <p>Note</p> <ul style="list-style-type: none"> Not in use when setting "Auto power on", "On/Off Timer" or PC input display. "No activity for 3 hours was activated" will be displayed for about 10 seconds when the TV is turned on for the first time after turning the power off by "No activity for 3 hours". The on-screen display will flash 3, 2 and 1 to indicate the last three (3) remaining minutes prior to the shut-off. 	<p>No activity for 3 hours</p> <p>Disable</p>
<p>Turns TV On automatically when the cable box or a connected device is turned On (No/Yes)</p> <p>TV AC cord must be plugged into this device. TV comes on every time the power is restored.</p> <ul style="list-style-type: none"> The "Sleep" timer, "On / Off timer", and "First time setup" will not function if "Auto power on" is set. (p. 44) 	<p>Auto power on</p> <p>No</p>
<p>Set "Thumbnail" or "Slideshow" to play back SD cards automatically. (Slideshow/Thumbnail/Set later/Off)</p>	<p>Play SD card automatically</p> <p>Set later</p>
<p>Displays TV version and software license.</p>	<p>About</p>
<p>Performing Reset will clear all items set with Setup, such as channel settings. (p. 40)</p>	<p>Reset to defaults</p>

Adjustments/Configurations (alternatives)

<p>Sets the mode to select the channel with Channel up/down button (All/Favorite/Digital only/Analog only)</p>	
<p>Sets favorite channels. (p. 20)</p>	
<p>Changes the station identifier. (p. 41)</p>	
<p>Checks the signal strength if interference or freezing occurs on a digital image. (p. 41)</p>	

VIERA Link™ “HDAVI Control™”*

Simultaneously control all Panasonic “HDAVI Control” equipped components using one button on the TV remote. Enjoy additional HDMI Inter-Operability with Panasonic products which have the “HDAVI Control” function. This TV supports “HDAVI Control 4” function.

Connections to the equipment (DVD recorder DIGA, HD Camcorder, Player theater, RAM theater, Amplifier, etc.) with HDMI cables allow you to interface with them automatically.

Equipment with the “HDAVI Control” function enables the following operations:

Version	Operations
HDAVI Control or later	<ul style="list-style-type: none">● Automatic Input Switching (p. 35)● Power on link (p. 35)● Power off link (p. 35)● Default speakers (p. 35)● One-touch theater playback (p. 35)● Speaker control (p. 37)
HDAVI Control 2 or later	<ul style="list-style-type: none">● VIERA Link control only with the TV’s remote control(P. 37)● Auto power stand-by (for available equipment only) (p. 35)
HDAVI Control 3 or later	<ul style="list-style-type: none">● Providing the setting information (p. 35)● Automatic lip-sync function (p. 35)
HDAVI Control 4	<ul style="list-style-type: none">● Stand-by power save (with quick start mode) (p. 35)

■ **For the first time/When adding new equipment, reconnecting equipment or changing the setup after the connection, turn the equipment on and then switch the TV on. Set the input mode to HDMI1 or HDMI2 (p. 24), and make sure that the image is displayed correctly.**

VIERA Link “HDAVI Control”, based on the control functions provided by HDMI which is an industry standard known as HDMI CEC (Consumer Electronics Control), is a unique function that we have developed and added. As such, its operation with other manufacturers’ equipment that supports HDMI CEC cannot be guaranteed.

Please refer to the individual manuals for other manufacturers’ equipment supporting the VIERA Link function.

■ HDMI cable

This function needs an HDMI compliant (fully wired) cable. Non-HDMI-compliant cables cannot be utilized.

It is recommended that you use Panasonic’s HDMI cable. Recommended part number:

RP-CDHF15 (4.9 ft/1.5 m), RP-CDHG15 (4.9 ft/1.5 m), RP-CDHF30 (9.8 ft/3.0 m),

RP-CDHG30 (9.8 ft/3.0 m), RP-CDHG50 (16.4 ft/5.0 m)

* For more details on the external equipment’s connections, please refer to the operating manuals for the equipment.

VIERA Link™ Connections

Follow the connection diagrams below for HDAVI control of a single piece of AV equipment such as a DVD recorder (DIGA), RAM theater, or Player theater system. Refer to page 34-37 for Setup Menu settings and additional control information.

- Optional HDMI and/or optical cables are not included.

If connection (or setting) of equipment compatible with HDAVI control is changed, switch the power of this unit Off and On again while the power of all equipment is On (so that the unit can correctly recognize the connected equipment) and check that the DVD recorder (DIGA), RAM theater, and Player theater playback operate.

Note

- HDMI 1 is recommended.

When connecting to HDMI 2, set the input mode to HDMI 2 (p. 24) initially before connecting to HDMI 2. After connection, confirm the HDMI control functions (p. 34-37).

■ Connecting this unit to the DVD recorder (DIGA), RAM theater, or Player theater

- For DVD recorder (DIGA): Connect with HDMI cable
- For RAM theater and Player theater: Connect with the HDMI and audio cables. If audio cable is not connected, you cannot listen to the TV program through the theater system.

■ Connecting this unit to a DVD recorder (DIGA) and AV amp

When using a "VIERA Link" audio-video amplifier and a compatible DVD recorder (DIGA) use a daisy chain connection as shown below.

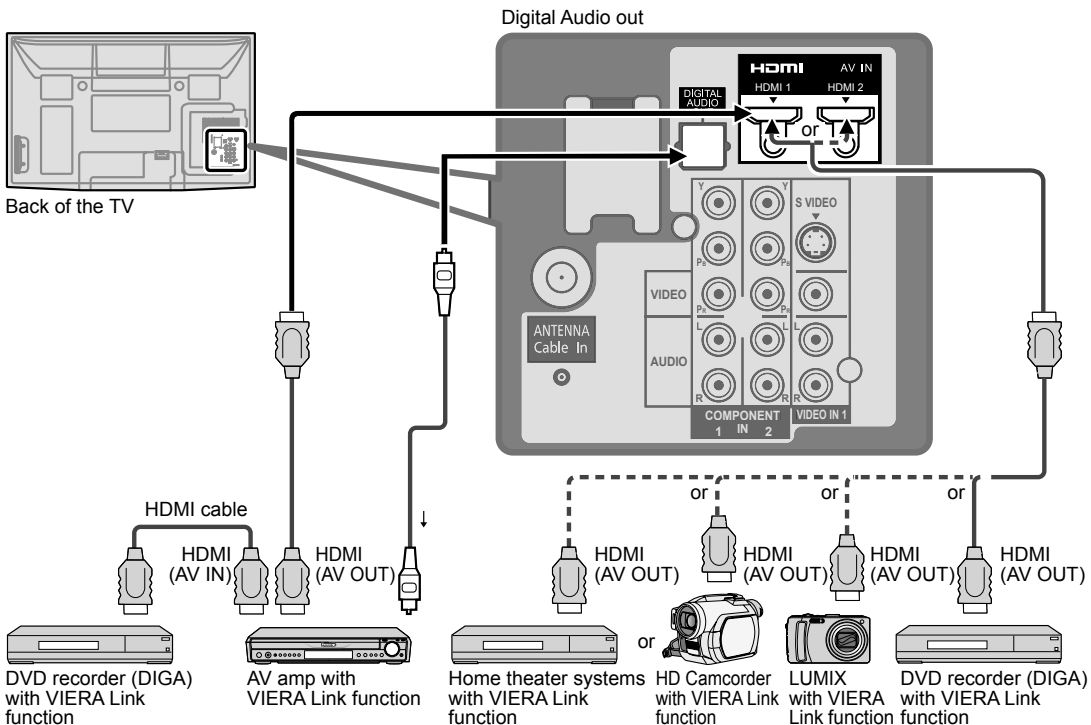

- One AV amp and one DVD recorder (DIGA) can be operated with this unit.
- Be sure to connect the AV amp between this unit and the DVD recorder (DIGA).

■ Setting of this unit after connection

After making connections as shown above, set "VIERA Link" (under "VIERA Link settings") to "On" using the Setup menu. (p. 25, 34-35).

Note

- Individual HDMI equipment may require additional menu settings specific to each model. Please refer to their respective operating instruction manuals.
- When audio from other equipment connected to this unit via HDMI is output using "DIGITAL AUDIO OUT" of this unit, the system switches to 2CH audio. (When connecting to an AV amp via HDMI, you can enjoy higher sound quality.)
- About HDMI cable for connecting Panasonic HD camcorder, read the manual of the equipment.

VIERA Link™ “HDAVI Control™”*

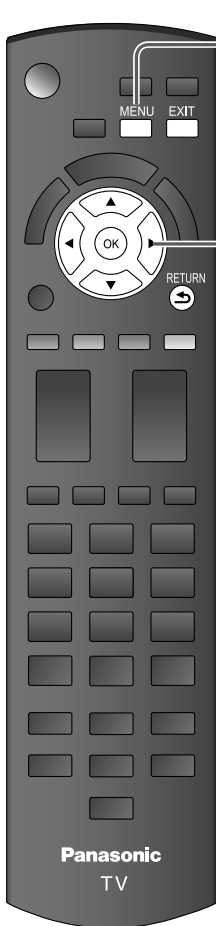

1 Display menu



2 Select “Setup”

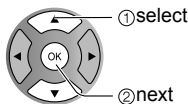
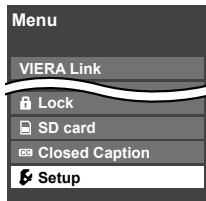

3 Select “VIERA Link settings”

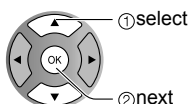
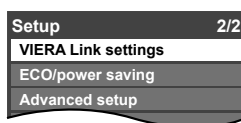

4 Select “VIERA Link”

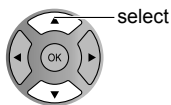
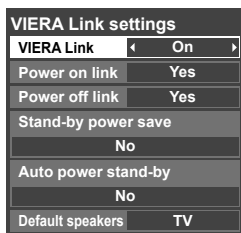

5 Select “On” (default is On)

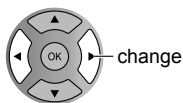

6 Select settings

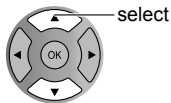
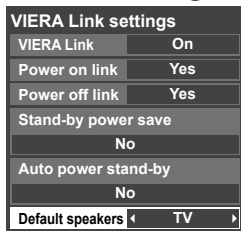

7 Set

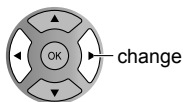
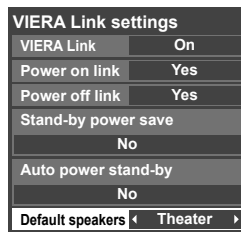

■ Press to exit from a menu screen



■ Press to return to the previous screen



Automatic Input Switching

Power on link

Power off link

Stand-by power save (for “HDAVI Control 4” (with quick start mode))

Auto power stand-by (for “HDAVI Control 2 or later”)

Default speakers

One-touch theater playback

Providing the setting information (for “HDAVI Control 3 or later”)

Automatic lip-sync function (for “HDAVI Control 3 or later”)

(Continued)

At the start of the DIGA, Player theater, or RAM theater playback, the TV's input automatically switches to the input based on the playback equipment.

- For the RAM theater, the speakers automatically switch to the theater system.
If using the DIGA operation, the TV's input automatically switches to the DIGA and DIGA menu is displayed.

When "Yes" is selected (p. 31), TV is turned on automatically and switches to the appropriate HDMI input whenever VIERA Link compatible equipment is initially turned on and Play mode is selected.

When "Yes" is selected (p. 31) and the TV is turned off, all connected VIERA Link compatible equipment is also automatically turned off.

- DIGA (Panasonic DVD Recorder) will not turn off if it is still in rec mode.
- Caution:** The TV remains on even if the VIERA Link compatible equipment is turned off.

- Condition
Power off link: Yes, Stand-by power save: Yes
The equipment has "HDAVI Control 4 (with quick start mode)" connected with HDMI cable.

When TV is turned off, all connected VIERA Link compatible equipment is moved to ECO standby mode* automatically under above conditions.

* Minimum power consumption of standby condition for the equipment.

- Condition
Auto power stand-by: Yes,
The equipment has "HDAVI Control 2 or later" (for available equipment only) connected with HDMI cable.
[Examples of timing for operation]
 - When the input is switched from HDMI.
 - When the "Speaker output" is changed from "Home theater" to "TV".

The connected VIERA Link compatible equipment will be turned off automatically when not in use.

"TV" is the default setting. To set the Home Theater system as default speakers, change the default speakers setting from "TV" to "Theater". Sound will be output from the Home Theater whenever the TV is powered on.

If the "ONE TOUCH PLAY" key is pressed on the remote control for Panasonic Home Theater system, the following sequence of operations is performed automatically.

- ① Home Theater power switches On, and playback begins.
- ② TV power switches On, and the playback screen is displayed.
- ③ Audio is muted on the TV and switches to the theater system.

The following information about the TV settings can be transmitted to each piece of equipment (Recorder/Home theater/Player) that has "HDAVI Control 3 or later" function connected to a TV with HDMI cable.

Transmittable data	Recorder	Home theater	Player
① On Screen Display Language setting (English/Español/Français)	○	○	○
② Panel Aspect Ratio (16:9 fixed)	○	○	○
③ Closed caption information (Mode/CC type/Digital setting)	○	---	---
④ Channel information (Input signal/Channel list/Caption information)	○	---	---

Note

- There is a possibility that all the GUI language information might be set from equipment that has HDMI CEC function connected to TV with HDMI cable. Depending on operating conditions or the specification for each piece of equipment the setting may or may not be applied.
- For more details on the external equipment's operation, please refer to the operating manuals for the equipment.

[For Recorder]

- You cannot operate other functions while transmitting TV's information above except Power On/Off key operation.
When you turn off this unit, the transmission will be interrupted (only when you are transmitting ④ Channel information).

Minimizes lip-sync delays between the picture and audio when you connect to a Panasonic theater system or Amplifier.

VIERA Link™ “HDAVI Control™”

You can enjoy more convenient operation with the “HDAVI Control” function in the “VIERA Link” menu.

For more details on the “HDAVI Control” function, refer to p. 32

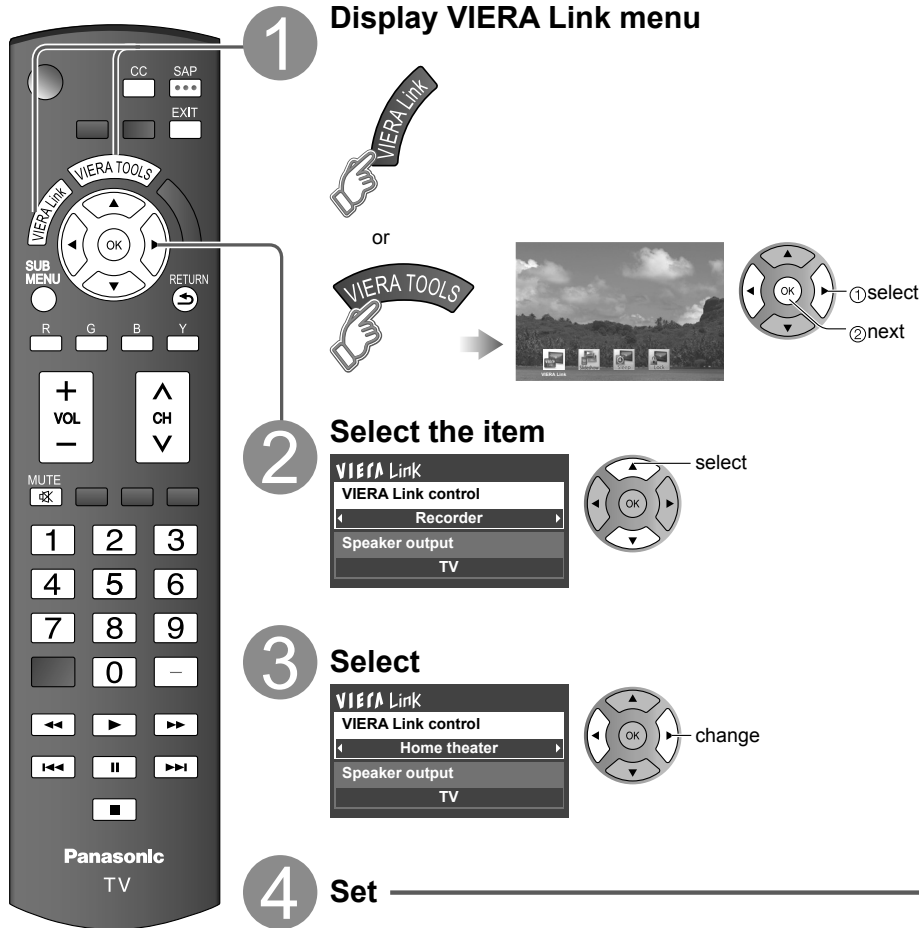

■ Press to exit from a menu screen



■ Press to return to the previous screen



Speaker control

VIERA Link control only with the TV's remote control (for “HDAVI Control 2 or later”)

(Continued)

You can select Home theater or TV speakers for audio output.
Control theater speakers with the TV's remote control.
This function is available only when Panasonic Amplifier or Player theater is connected.

- ① Select "Speaker output"
- ② Select "Home theater" or "TV"

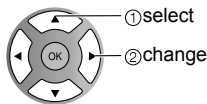
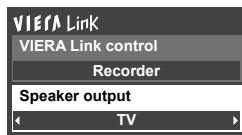

■ Home theater: Adjustment for equipment

Volume up / down →

Mute →

- The sound of the TV is muted.
- When the equipment is turned off, the TV speakers take over.
- Selecting "Home theater" turns the equipment on automatically if it is in standby mode.

■ TV: The TV speakers are on.

In the VIERA Link menu, you can select HDMI connected equipment and access it quickly. Continue using your TV's remote control to operate the equipment, pointing it at the TV.

- ① Select "VIERA Link control"
- ② Select the equipment you want to access.
(Recorder/Home theater/Player/Camcorder/LUMIX)

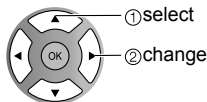
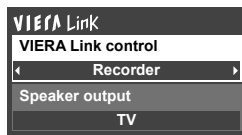

- If there is more than one equipment item, a number after the name indicates the number of items. (e.g. Recorder 1/Recorder 2/Recorder 3...)
- The number of equipment items that can be connected is three for recorders, and a total of three for Home theater/Player/Camcorder/LUMIX.

Note

- There is a limit to the number of HDMI connectors.

You can select available items only.

- ③ Operate the equipment with the TV's remote control, pointing it at the TV.

- To operate the equipment, read the manual of the equipment.

■ Available TV's remote control buttons

Whether an operation is available differs depending on the connected equipment.

	Move the cursor/Select		Play
	Set/Access		Stop
	Return to previous menu		Reverse/Forward
	Display the functions menu on the equipment		Skip Reverse/Forward
	Available when the purpose of the keys is displayed on screen		Pause
	Exit		Closed Caption
	Channel Up/Down		SAP (Select Audio Mode)
	0-9		Select digital subchannel

Lock

You can lock specified channels or shows to prevent children from watching objectionable content.

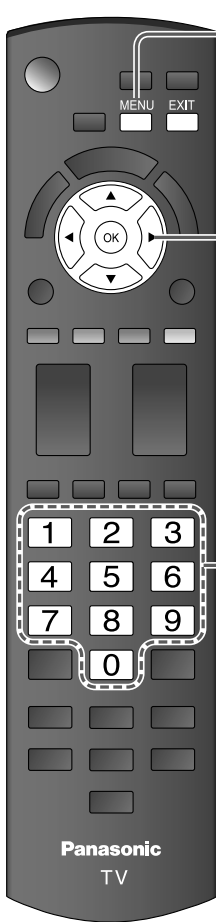

1 Display menu



2 Select "Lock"

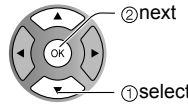
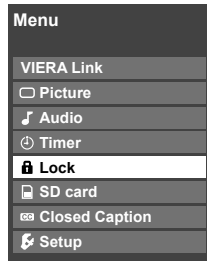

You will be asked to enter your password each time you display the Lock menu.

3 Input your 4-digit password

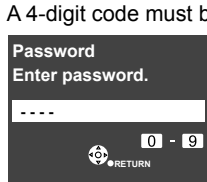

A 4-digit code must be entered to view a blocked program or change rating settings.

- If it is your first time entering the password, enter the password twice in order to register it.

4 Select the Lock mode

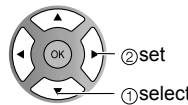
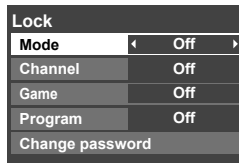

Off: Unlocks all the lock settings of "Channel", "Game" and "Program".

All: Locks all the inputs regardless of the lock settings of "Channel", "Game" and "Program".

Custom: Locks specified inputs of "Channel", "Game" and "Program".

Press to exit from a menu screen



Caution

- Make a note of your password in case you forget it. (If you have forgotten your password, consult your local dealer.)

Note

- When you select a locked channel, a message will be displayed that allows you to view the channel if you input your password.

5 Select the item

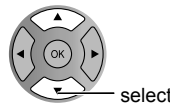
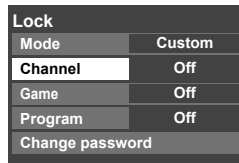

- "Channel", "Game" and "Program" are not accessible unless "Custom" is selected in "Mode".

6 Set

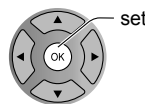

■ To select the channel or the rating of the program to be locked

Channel lock

Select up to 7 (1-7) channels to be blocked. These channels will be blocked regardless of the program rating.

- ① Select "Mode" and set to "Custom"
- ② Select channel to lock.

Channel lock	
Mode	Custom
Channel 1	3
Channel 2	4
Channel 3	-
Channel 4	-

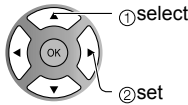

- To lock/unlock all channels: Select "Mode" and set to "All" or "Off".

All: Locks all channels
Off: Unlocks all channels

Game lock

Locks Channel 3, Channel 4 and external inputs.

- ⑤ Select "Game" in ⑤ and set to "On".

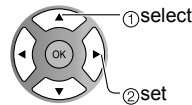

On: Locks
Off: Unlocks

Program lock

■ To set a rating level

"V-chip" technology enables restricted shows to be locked according to TV ratings.

- ① Select "Mode" and set to "On".

Program lock	
Mode	On
MPAA	Off
U.S.TV	Off
C.E.L.R.	Off
C.F.L.R.	Off

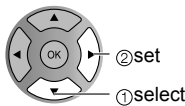

- ② Select the rating category you wish to follow

Program lock	
Mode	On
MPAA	Off
U.S.TV	Off
C.E.L.R.	Off
C.F.L.R.	Off

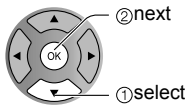

MPAA: U.S movie ratings
U.S.TV: U.S TV program ratings
C.E.L.R.:Canadian English ratings
C.F.L.R.:Canadian French ratings

- ③ Select the rating to be locked

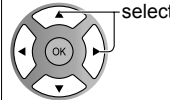

Example of "MPAA" (U.S movie ratings)

NR	No rating
G	General Audience: All ages admitted
PG	Parental Guidance Suggested
PG-13	Parents Strongly Cautioned: Inappropriate for children under 13
R	Restricted: Under 17 requires accompanying parent or adult guardian
NC-17	No one 17 and under admitted
X	Adults only

- To get more information (p. 46)

Change password

■ To change the password

- ① In ④, select "Change password" and press OK
- ② Input the new 4-digit password twice

Lock	Off
Mode	Off
Channel	Off
Game	Off
Program	Off
Change password	

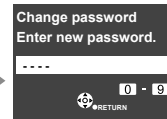

Note

- This television is designed to support the "Downloadable U.S. Region Rating System" when available. (Available only in U.S.A.)
- The Off rating is independent of other ratings.
- When placing a lock on a specific-age-based-rating level, the Off rating and any other more restrictive ratings will also be blocked.

Editing and Setting Channels

The current channel settings can be changed according to your needs and reception conditions.

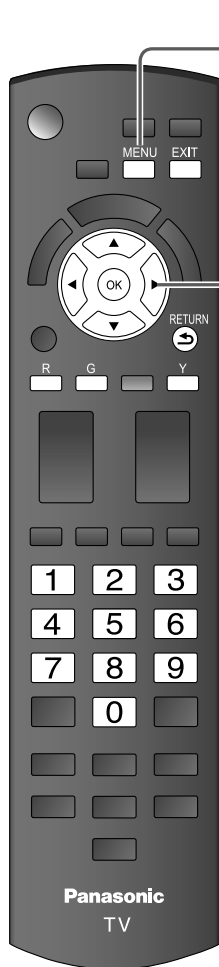

1 Display menu



2 Select "Setup"

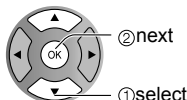
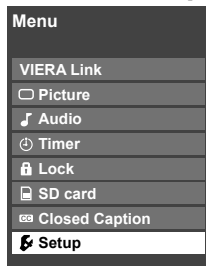

3 Select "ANT/Cable setup"

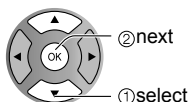
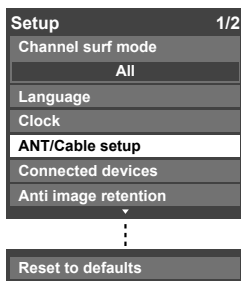

4 Select the function

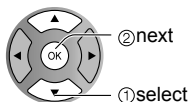
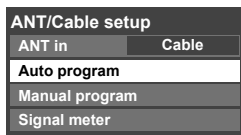

■ Press to exit from a menu screen



5 Set

■ To reset the settings of setup menu

- ① Select "Reset to defaults" in Setup menu (3) and press OK
- ② Input your 4-digit password with number buttons
- ③ Select "YES" on the confirmation screen and press OK

Auto program
Set automatically

Manual program
Set manually

Signal meter
Check signal strength

Automatically searches and adds available channels to the memory.

① **Select “ANT in”**

- ➔ Select Cable or Antenna.
Or select “Not used” (p. 17).

② **Select “Auto program”**

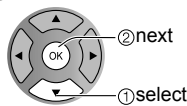
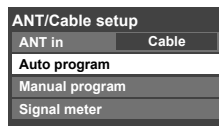

③ **Select a scanning mode** (p. 18)

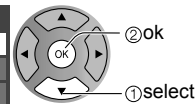
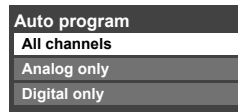

Settings are made automatically

- After the scanning is completed, select “Apply” (see below ⑤).
- All previously saved channels are erased.

Use this procedure when changing the channel setup or changing the channel display. Also, use this to add or skip channels from the channel list manually.

You can select a channel tuning mode (Digital only/ Analog only) in “Channel surf mode”(p. 31)

① **Select “Edit”**

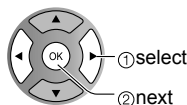
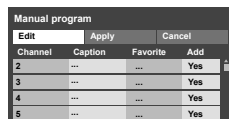

② **Select the item to be edited**

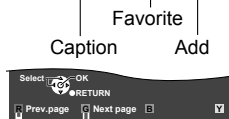
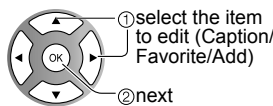
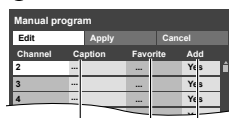

- **Caption:** Changes the station identifier
- **Favorite:** Registers channel to Favorite List
- **Add:** Adds or skips channels

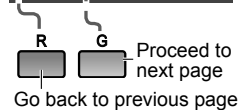

③ **Edit**

● **Caption**

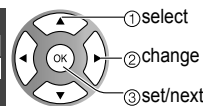

Caption

Select or edit the station identifier.
(maximum 7 characters available)

● **Favorite**

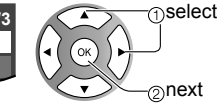

Set favorite Select the number

● **Add**

Press OK to select “Yes (add)” or “No (skip)”



④ **Move cursor to channel number**

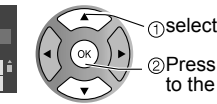
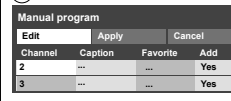

⑤ **Select “Apply”**

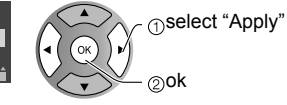

To cancel the Edit

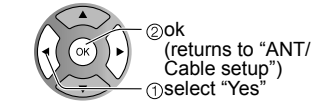
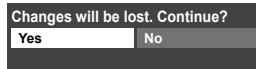
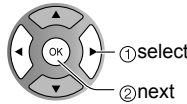
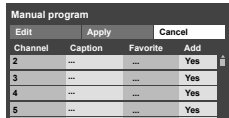

Check the signal strength if an interference is found or freezing occurs on a digital image.

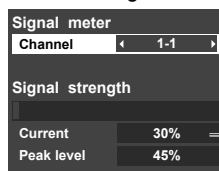

- If the signal is weak, check the antenna.
If no problem is found, consult your local dealer.

Note

- Not available if “Cable” is selected in “ANT in” (see above).
- Available only for digital antenna channels.

● If “Lock” (p. 38) is activated and “ANT/Cable setup” is selected, “Enter password.” will be displayed.

Closed Caption

1 Display menu



2 Select "Closed Caption"

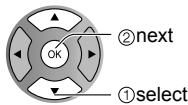

Menu

- VIERA Link
- Picture
- Audio
- Timer
- Lock
- SD card
- Closed Caption**
- Setup

Press to exit from a menu screen

EXIT



The television includes a built-in decoder that is capable of providing a text display of the audio. The program being viewed must be transmitting Closed Caption (CC) information. (p. 47)

Select the item and set

Closed Caption

Reset to defaults

Mode	On
Analog	CC1
Digital	Primary
Digital setting	

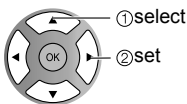

Mode Select "On" (when not using, select "Off").

Analog (Choose the Closed Caption service of Analog broadcasting.)

CC1-4: Information related to pictures (Appears at bottom of screen)

T1-4: Textual information (Appears over entire screen)

Digital (The Digital Closed Caption menu lets you configure the way you choose to view the digital captioning.)

Select the setting.

- "Primary", "Second.", "Service 3", "Service 4", "Service 5", "Service 6"

- The settings in "Analog" or "Digital" depend on the broadcaster.

Closed Caption

Display Closed Caption

To make more in-depth display settings in digital programs

① Select "Digital setting" and press OK

② Select the item and set

Digital setting

Size	Automatic
Font	Automatic
Style	Automatic
Foreground	Automatic
Fore. opacity	Automatic
Background	Automatic
Back. opacity	Automatic
Outline	Automatic

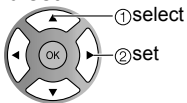



- Size: Text size
- Font: Text font
- Style: Text style (Raised, Depressed, etc.)
- Foreground: Color of text
- Fore. opacity: Opacity of text
- Background: Color of text box
- Back. opacity: Opacity of text box
- Outline: Outline color of text (Identify the setting options on the screen.)

To reset the settings

Select "Reset to defaults" and press OK

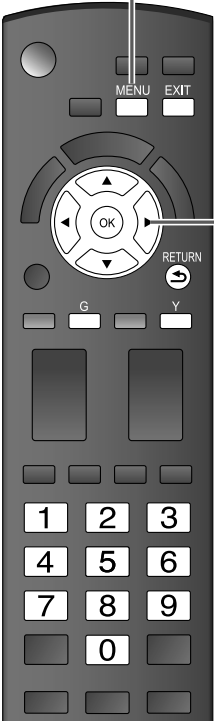
Input Labels

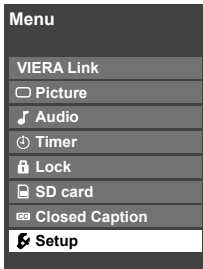
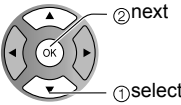
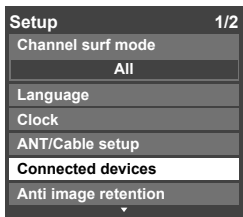
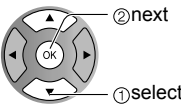
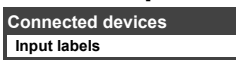
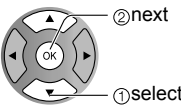

- 1 **Display menu**

- 2 **Select "Setup"**

- 3 **Select "Connected devices"**

- 4 **Select "Input labels"**



■ Press to exit from a menu screen

● Input Labels
 ● Closed Caption

Advanced

Input labels Display labels of Connected devices

Devices connected to external input terminals can be labeled for easier identification during input selection. (In selecting input mode from p. 24 ②)

■ Select the terminal and label of the external equipment

Input labels	
Component 1	◀ ▶
Component 2	
HDMI 1	
HDMI 2	
Video 1	
Video 2	GAME
PC	

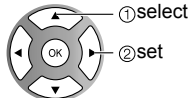

OR

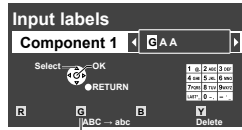

Switches Input mode from alphabetical to numeric

- Terminals: Component 1-2/HDMI 1-2/Video 1-2/PC
 - Label: [BLANK] SKIP/VCR/DVD/CABLE/SATELLITE/DVR/GAME/AUX/RECEIVER/COMPUTER/Blu-ray/CAMERA/DVD REC/HOME THTR/MONITOR/MEDIA CTR/MEDIA EXT/OTHER
- For the PC terminal, only "SKIP" is available.
- * If "SKIP" is selected, the INPUT button press will skip its input.
 - Each selected label will be displayed on "Input select" screen. (p. 24)



Using Timer

The TV can automatically turn On/Off at the designated date and time.

- The Clock must be set before On time/Off time settings. (p. 17)
- The "Sleep" timer and "On / Off timer" will not work if the "Auto power on" (p. 30) is set.

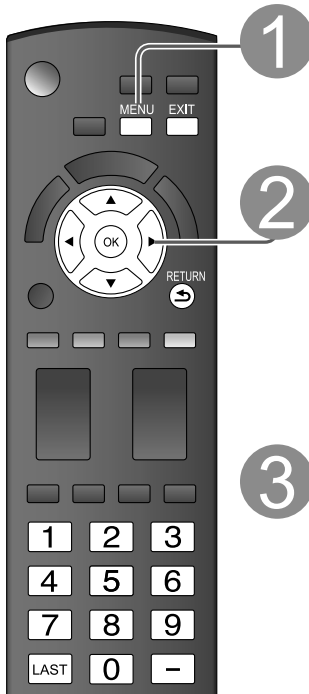

1 Display menu



2 Select "Timer"

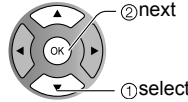
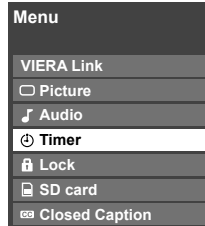

3 Select the timer to set

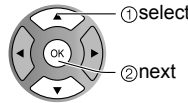
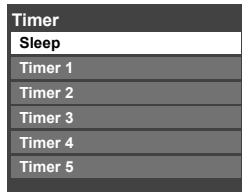

- Sleep** Turns Off automatically
- Timer 1** Turns On/Off automatically (5 timers can be set.)
- Timer 5**

4 Press to exit from a menu screen



Press to return to the previous screen



Note

- The TV automatically turns Off after 90 minutes when turned On by the Timer. This operation will be cancelled if the Off time is selected or if a key is pressed.

4 Set the timer

To set "Sleep" (Off Timer)

Set to shut the unit off after a pre-selected amount of time.



- 0/30/60/90 (minutes)

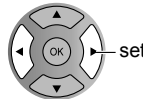

To set "Timer 1-5" (On/Off Timer)

Select the item and set

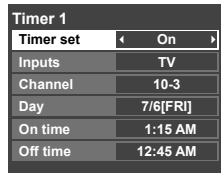

- LAST** AM/PM
- Clear
- Timer set** Timer setting (On/Off)
- Inputs** Select the inputs
- Channel** Select the channel
- Day** Select the day
- SUN/MON/TUE/WED/THU/FRI/SAT (displays the nearest future date)
- MON-FRI/SAT-SUN/DAILY/Every SUN/Every MON/Every TUE/Every WED/Every THU/Every FRI/ Every SAT
- On time** The time to turn On
- Off time** The time to turn Off

Recommended AV Connections

These diagrams show our recommendations or how to connect the TV unit to your various equipment. For other connections, consult the instructions for each piece of equipment and its specifications. For additional assistance, please visit our website at: www.panasonic.com www.panasonic.ca

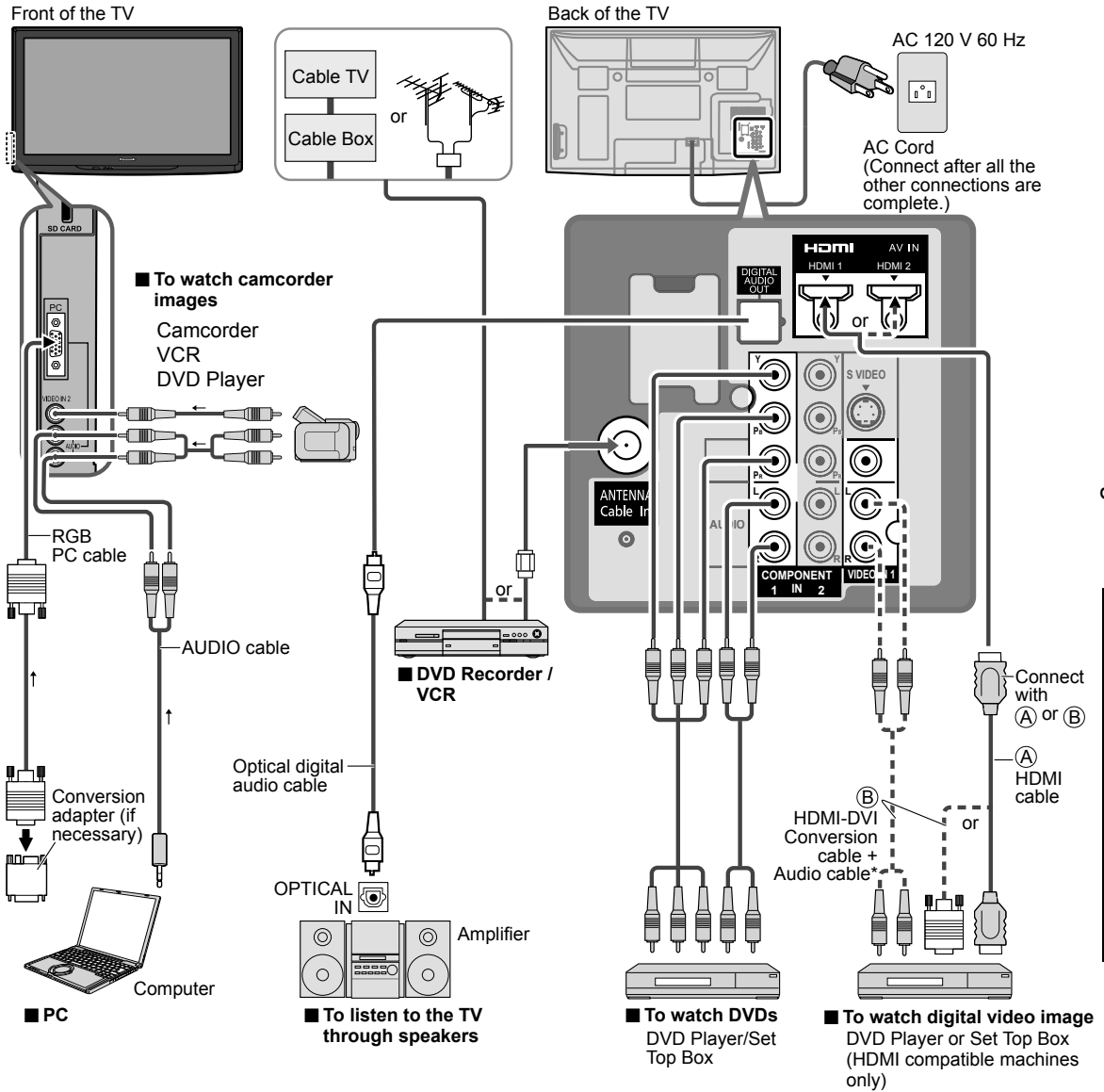

● Recommended AV Connections
● Using Timer

Advanced

* Please see p. 28-29 for setup when using an external analog audio cable with an HDMI to DVI cable.

Ratings List for Lock

“V-chip” technology enables you to lock channels or shows according to standard ratings set by the entertainment industry. (p. 39)

■ U.S. MOVIE RATINGS (MPAA)

NR	NO RATING (NOT RATED) AND NA (NOT APPLICABLE) PROGRAMS. Movie which has not been rated or where rating does not apply.
G	GENERAL AUDIENCES. All ages admitted.
PG	PARENTAL GUIDANCE SUGGESTED. Some material may not be suitable for children.
PG-13	PARENTS STRONGLY CAUTIONED. Some material may be inappropriate for children under 13.
R	RESTRICTED. Under 17 requires accompanying parent or adult guardian.
NC-17	NO ONE 17 AND UNDER ADMITTED.
X	ADULTS ONLY.

■ U.S. TV PROGRAMS RATINGS (U. S. TV)

Age-based Group	Age-based Ratings	Possible Content Selections	Description
NR (Not Rated)	TV-NR	<ul style="list-style-type: none"> Viewable Blocked 	Not Rated.
Youth	TV-Y	<ul style="list-style-type: none"> Viewable Blocked 	All children. The themes and elements in this program are specifically designed for a very young audience, including children from ages 2-6.
	TV-Y7	<ul style="list-style-type: none"> FV Blocked Viewable Blocked 	Directed to older children. Themes and elements in this program may include mild physical or comedic violence, or may frighten children under the age of 7.
Guidance	TV-G	<ul style="list-style-type: none"> Viewable Blocked 	General audience. It contains little or no violence, no strong language, and little or no sexual dialogue or situations.
	TV-PG	<ul style="list-style-type: none"> D, L, S, V (all selected) Any combination of D, L, S, V 	Parental guidance suggested. The program may contain infrequent coarse language, limited violence, some suggestive sexual dialogue and situations.
	TV-14	<ul style="list-style-type: none"> D, L, S, V (all selected) Any combination of D, L, S, V 	Parents strongly cautioned. This program may contain sophisticated themes, sexual content, strong language and more intense violence.
	TV-MA	<ul style="list-style-type: none"> L, S, V (all selected) Any combination of L, S, V 	Mature audiences only. This program may contain mature themes, profane language, graphic violence, and explicit sexual content.

FV: Fantasy/Cartoon Violence. V: Violence S: Sex L: Offensive Language D: Dialogue with sexual content.

■ CANADIAN ENGLISH RATINGS (C. E. L. R.)

E	Exempt - Exempt programming includes: news, sports, documentaries and other information programming, talk shows, music videos, and variety programming.
C	Programming intended for children under age 8. No offensive language, nudity or sexual content.
C8+	Programming generally considered acceptable for children 8 years and over. No profanity, nudity or sexual content.
G	General programming, suitable for all audiences.
PG	Parental Guidance suggested. Some material may not be suitable for children.
14+	Programming contains themes or content which may not be suitable for viewers under the age of 14. Parents are strongly cautioned to exercise discretion in permitting viewing by pre-teens and early teens.
18+	18+ years old. Programming restricted to adults. Contains constant violence or scenes of extreme violence.

■ CANADIAN FRENCH RATINGS (C. F. L. R.)

E	Exempt - Exempt programming.
G	General - Programming intended for audience of all ages. Contains no violence, or the violence content is minimal or is depicted appropriately.
8 ans+	8+ General - Not recommended for young children. Programming intended for a broad audience but contains light or occasional violence. Adult supervision recommended.
13 ans+	Programming may not be suitable for children under the age of 13 - Contains either a few violent scenes or one or more sufficiently violent scenes to affect them. Adult supervision strongly suggested.
16 ans+	Programming may not be suitable for children under the age of 16 - Contains frequent scenes of violence or intense violence.
18 ans+	Programming restricted to adults. Contains constant violence or scenes of extreme violence.

Caution

- The V-Chip system that is used in this set is capable of blocking “NR” programs (non rated, not applicable and none) as per FCC Rules Section 15.120(e)(2). If the option of blocking “NR” programs is chosen “unexpected and possibly confusing results may occur, and you may not receive emergency bulletins or any of the following types of programming:”
 - Emergency Bulletins (Such as EAS messages, weather warnings and others)
 - Locally originated programming • News • Political • Public Service Announcements • Religious • Sports • Weather

Technical Information

Closed Caption (CC)

- For viewing the CC of digital broadcasting, set the aspect to FULL (If viewing with H-FILL, JUST, ZOOM or 4:3; characters might be cut off).
- The CC can be displayed on the TV if the receiver (such as a set-top box or satellite receiver) has the CC set On using the Component or HDMI connection to the TV.
- If the CC is set to On on both the receiver and TV when the signal is 480i (except for the HDMI connection), the CC may overlap on the TV.
- If a digital program is being output in analog format, the CC data will also be output in analog format.
- If the recorder or output monitor is connected to the TV, the CC needs to be set up on the recorder or output monitor.

Aspect Ratio (FORMAT)

Press the FORMAT button to cycle through the aspect modes. This lets you choose the aspect depending on the format of the received signal and your preference. (p. 20)
(e.g.: in case of 4:3 image)

● FULL

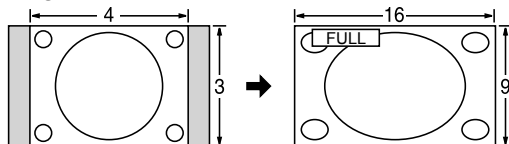

Enlarges the 4:3 image horizontally to the screen's side edges. (Recommended for anamorphic picture)

● JUST

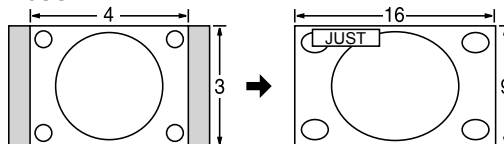

Stretches to justify the 4:3 image to the four corners of the screen. (Recommended for normal TV broadcast)

● H-FILL

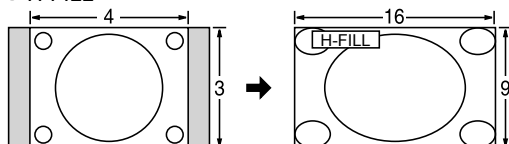

Enlarges the 4:3 image horizontally to the screen's side edges. The side edges of the image are cut off.

● 4:3

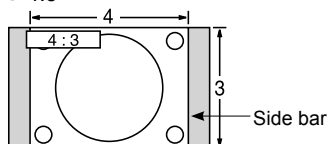

Standard (Note that "Image retention" of the side bar may occur from displaying it for a long time.)

● ZOOM

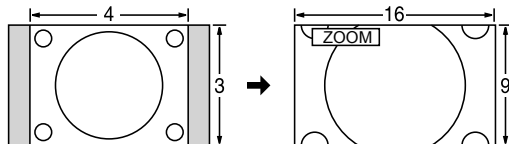

Enlarges the 4:3 image to the entire screen. (Recommended for Letter Box)

Note

- 480i (4:3), 480i (16:9), 480p (4:3), 480p (16:9): FULL, JUST, 4:3 or ZOOM
- 1080p / 1080i / 720p: FULL, H-FILL, JUST, 4:3 or ZOOM

● Zoom adjustments

Vertical image position and size can be adjusted in "ZOOM".

① Select "Zoom adjustments" on the "Picture" menu. (p. 28-29)

② V-position: Vertical position adjustment

③ V-size: Vertical size adjustment

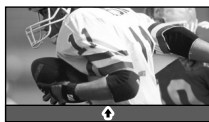

- To reset the aspect ratio →  (OK)

Technical Information

Data format for SD Card browsing

Photo:	Still images recorded with digital still cameras compatible with JPEG files of DCF* and EXIF** standards
Data format:	Baseline JPEG (Sub-sampling: 4:4:4, 4:2:2 or 4:2:0)
Max. number of files:	9,999
Image resolution:	160 x 120 to 10,000,000

* DCF (Design rule for camera file system): A Japan Electronics and Information Technology Industries Association's standard
 ** EXIF (Exchangeable Image File Format)

Caution

- A JPEG image modified with a PC may not be displayed.
- Partly degraded files might be displayed at a reduced resolution.

Note

- Folder structure viewed in PC

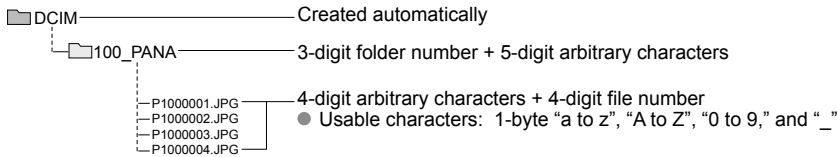

- The folder and file names may be different depending on the digital camera used.
- For the suitable SD Memory Cards, please confirm the latest information on the following website.
<http://panasonic.jp/support/global/cs> (This site is in English only)

Cautions in handling SD Card:

- Do not remove the card while the unit is accessing data (this can damage card or unit).
- Do not touch the terminals on the back of the card.
- Do not subject the card to high pressure or impact.
- Insert the card in the correct direction (otherwise, card may be damaged).
- Electrical interference, static electricity or erroneous operation may damage the data or card.
- Back up the recorded data at regular intervals in case of deteriorated or damaged data or erratic operation of the unit. (Panasonic is not liable for any deterioration or damage of recorded data.)

SD Card warning messages

Message	Meaning
SD card slot is empty.	● The card is not inserted.
No photos	● The card has no data or this type of data is not supported.
Cannot read file	<ul style="list-style-type: none"> ● The file is broken or unreadable. ● The TV does not support the format.

(Continued)

VIERA Link™ “HDAVI Control™”

HDMI connections to some Panasonic equipment allow you to interface automatically. (p. 32)

- This function may not work normally depending on the equipment condition.
- The equipment can be operated by other remote controls with this function on even if TV is in Standby mode.
- Image or sound may not be available for the first few seconds when the playback starts.
- Image or sound may not be available for the first few seconds when Input mode is switched.
- Volume function will be displayed when adjusting the volume of the equipment.
- If you connect the same kind of equipment at once (for example: one DIGA to HDMI 1 / another DIGA to HDMI 2), VIERA Link™ is available for the terminal with the smaller number.
- If you connect equipment that has “HDAVI Control 2 or later” function to the TV with HDMI cable, the sound from DIGITAL AUDIO OUT terminal can be output as multi channel surround.
- “HDAVI Control 4” is the newest standard (current as of December, 2008) for the HDAVI Control compatible equipment. This standard is compatible with the conventional HDAVI equipment.

HDMI connection

HDMI (high-definition multimedia interface) allows you to enjoy high-definition digital images and high-quality sound by connecting the TV unit and the devices.

HDMI-compatible equipment (*1) with an HDMI or DVI output terminal, such as a set-top box or a DVD player, can be connected to the HDMI connector using an HDMI compliant (fully wired) cable.

- HDMI is the world’s first complete digital consumer AV interface complying with a non-compression standard.
- If the external equipment has only a DVI output, connect to the HDMI terminal via a DVI to HDMI adapter cable (*2).
- When the DVI to HDMI adapter cable is used, connect the audio cable to the audio input terminal.
- Audio settings can be made on the “HDMI 1 in” or “HDMI 2 in” menu screen. (p. 28)

Applicable audio signal sampling frequencies (L.PCM): 48 kHz, 44.1 kHz, 32 kHz

(*1): The HDMI logo is displayed on an HDMI-compliant device.

(*2): Enquire at your local digital equipment retailer shop.

Caution

- Use with a PC is not assumed.
- All signals are reformatted before being displayed on the screen.
- If the connected device has an aspect adjustment function, set the aspect ratio to “16:9”.
- These HDMI connectors are “type A”.
- These HDMI connectors are compatible with HDCP (High-Bandwidth Digital Content Protection) copyright protection.
- A device having no digital output terminal may be connected to the input terminal of either “COMPONENT”, “S VIDEO”, or “VIDEO” to receive analog signals.
- The HDMI input terminal can be used with only the following image signals: 480i, 480p, 720p, 1080i and 1080p. Match the output setting of the digital device.
- For details of the applicable HDMI signals, see p. 50.

DIGITAL AUDIO OUT terminals

You can enjoy your home theater by connecting a Dolby Digital (5.1 channel) decoder and “Multi Channel” amplifier to the DIGITAL AUDIO OUT terminals.

Caution

- Depending on your DVD player and DVD-Audio software the copyright protection function may operate and disable optical output.
- When an ATSC channel is selected, the output from the DIGITAL AUDIO OUT jack will be Dolby Digital. When an NTSC channel is selected, the output will be PCM.

Picture mode

- Vivid: Provides enhanced picture contrast and sharpness for viewing in a well-lit room.
- Standard: Recommended for normal viewing conditions with subdued room lighting.
- Cinema: For watching movies in a darkened room. It provides a soft, film-like picture.
- Custom (Photo): Customizes each item according to your taste. Photo is displayed in JPEG menu.

Technical Information (Continued)

H size

- Aspect Ratio: 4:3

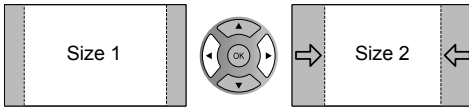

- The width will be decreased on both sides to reduce noise.

- Aspect Ratio: FULL/JUST(H-FILL/ZOOM)

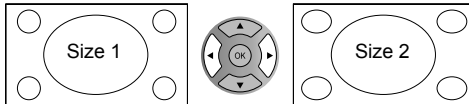

- The width will be increased on both sides to reduce noise.

See pages 28-29 for more information

4:3 side bars

Do not display a picture in 4:3 mode for an extended period, as this can cause "Image retention" to remain on either or both sides of the display field.

To reduce the risk of such "Image retention", change the brightness of the side bars.

See pages 30-31 for more information

- The side bar may flash (alternate black/white) depending on the picture. Using Cinema mode will reduce such flashing (See below).

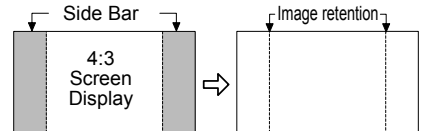

Scrolling bar

Scrolling bar: To prevent "Image retention", scrolls white vertical bar from left to right on a black screen.

- Press any key except the POWER key to return to previous screen.
 - You will return to the previous screen if no key operation has been performed for 15 minutes.
- See pages 30-31 for more information

[Scrolling bar]



Input signal that can be displayed

* Mark: Applicable input signal for Component (Y, Pb, Pr), HDMI and PC

	horizontal frequency (kHz)	vertical frequency (Hz)	COMPONENT	HDMI	PC
525 (480) / 60i	15.73	59.94	*	*	
525 (480) / 60p	31.47	59.94	*	*	
750 (720) / 60p	45.00	59.94	*	*	
1,125 (1,080) / 60i	33.75	59.94	*	*	
1,125 (1,080) / 60p	67.43	59.94		*	
1,125 (1,080) / 60p	67.50	60.00		*	
1,125 (1,080) / 24p	26.97	23.98		*	
1,125 (1,080) / 24p	27.00	24.00		*	
640 × 400 @70	31.47	70.08			*
640 × 480 @60	31.47	59.94			*
Macintosh13" (640 × 480)	35.00	66.67			*
640 × 480 @75	37.50	75.00			*
852 × 480 @60	31.47	59.94			*
800 × 600 @60	37.88	60.32			*
800 × 600 @75	46.88	75.00			*
800 × 600 @85	53.67	85.08			*
Macintosh16" (832 × 624)	49.73	74.55			*
1,024 × 768 @60	48.36	60.00			*
1,024 × 768 @70	56.48	70.07			*
1,024 × 768 @75	60.02	75.03			*
1,024 × 768 @85	68.68	85.00			*
Macintosh 21" (1,152 × 870)	68.68	75.06			*
1,280 × 1,024 @60	63.98	60.02			*
1,366 × 768 @60	48.36	60.00			*

Note

- Signals other than above may not be displayed properly.
- The above signals are reformatted for optimal viewing on your display.

PC Input Terminals Connection

- Computer signals which can be input are those with a horizontal scanning frequency of 15 to 110 kHz and vertical scanning frequency of 48 to 120 Hz. (However, the image will not be displayed properly if the signals exceed 1,200 lines.)
- Some PC models cannot be connected to the set.
- There is no need to use an adapter for computers with IBM PC/AT compatible D-sub 15P terminal.
- The maximum resolution: 1,280 × 1,024
- If the display resolution exceeds these maximums, it may not be possible to show fine detail with sufficient clarity.
- Signal Names for D-sub 15P Connector

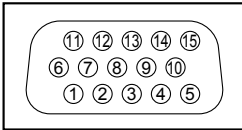

Pin Layout for PC Input Terminal

Pin No.	Signal Name	Pin No.	Signal Name	Pin No.	Signal Name
①	R	⑥	GND (Ground)	⑪	NC (not connected)
②	G	⑦	GND (Ground)	⑫	NC
③	B	⑧	GND (Ground)	⑬	HD/SYNC
④	NC (not connected)	⑨	NC (not connected)	⑭	VD
⑤	GND (Ground)	⑩	GND (Ground)	⑮	NC

Care and Cleaning

First, unplug the Power cord plug from the wall outlet.

Display panel

The front of the display panel has been specially treated. Wipe the panel surface gently using only a cleaning cloth or a soft, lint-free cloth.

- If the surface is particularly dirty, soak a soft, lint-free cloth in diluted mild liquid dish soap (1 part mild liquid dish soap diluted by 100 times the amount of water) and then wring the cloth to remove excess liquid. Use this cloth to wipe the surface of the display panel, then wipe it evenly with a dry cloth of the same type until the surface is dry.
- Do not scratch or hit the surface of the panel with fingernails or other hard objects. Furthermore, avoid contact with volatile substances such as insect sprays, solvents, and thinner; otherwise, the quality of the surface may be adversely affected.

Cabinet

If the cabinet becomes dirty, wipe it with a soft, dry cloth.

- If the cabinet is particularly dirty, soak the cloth in a weak mild liquid dish soap and then wring the cloth dry. Use this cloth to wipe the cabinet and then wipe it dry with a dry cloth.
- Do not allow any mild liquid dish soap to come into direct contact with the surface of the Plasma TV.
- If water droplets get inside the unit, operating problems may result.
- Avoid contact with volatile substances such as insect sprays, solvents, and thinner; otherwise, the quality of the cabinet surface may be adversely affected or the coating may peel off. Furthermore, do not leave it for long periods in contact with articles made from rubber or PVC.

Pedestal

Cleaning

- Wipe the surfaces with a soft, dry cloth. If the unit is particularly dirty, clean it using a cloth soaked with water to which a small amount of mild liquid dish soap has been added and then wipe with a dry cloth. Do not use products such as solvents, thinner, or household wax for cleaning, as they can damage the surface coating. (If using a chemically-treated cloth, follow the instructions supplied with the cloth.)
- Do not attach sticky tape or labels, as they can make the surface of the pedestal dirty. Do not allow long-term contact with rubber, vinyl products, or the like. (Doing so will cause deterioration.)

FAQ

Before requesting service or assistance, please follow these simple guides to resolve the problem.
If the problem still persists, please contact your local Panasonic dealer or Panasonic Service Center for assistance.
For details (p. 56, 57)
For additional assistance, please contact us via the website at:
www.panasonic.com/contactinfo
www.panasonic.ca

White spots or shadow images (noise)

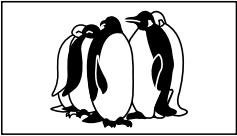

- Check the position, direction, and connection of the antenna.

Interference or frozen digital channels (intermittent sound)

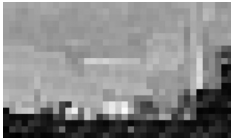

- Change the direction of antenna for digital channels.
- Check "Signal meter" (p. 41). If the signal is weak, check the antenna and consult your local dealer.

The remote control does not work

- Are the batteries installed correctly? (p. 8)
- Are the batteries new?

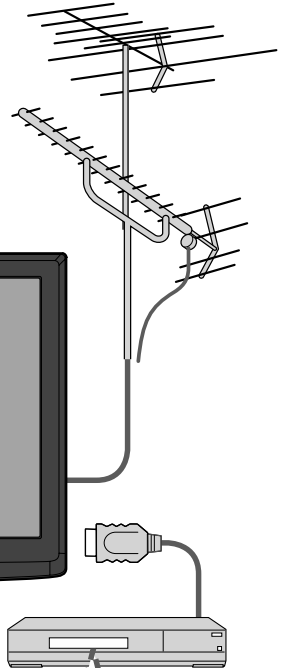
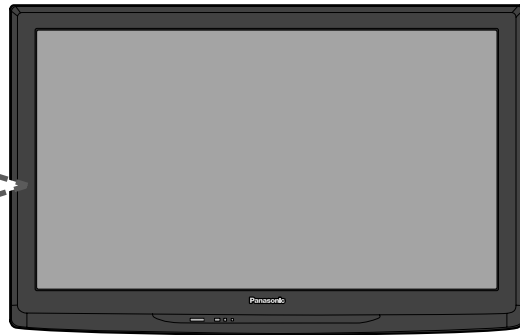

Pictures from external equipment are distorted when the unit is connected via HDMI

- Is the HDMI cable connected properly? (p. 33, 45)
- Turn Off the TV unit and equipment, then turn them On again.
- Check an input signal from the equipment. (p. 50)
- Use equipment compliant with EIA/CEA-861/861B.

When the channel is changed on an STB that is connected with HDMI, "HDMI" may be displayed on the top left of the screen

- This is not a malfunction.

Recording does not start immediately

- Check the settings of the recorder. For details, read the manual of the recorder.

If there is a problem with your TV, please refer to the table below to determine the symptoms, then carry out the suggested check. If this does not solve the problem, please contact your local Panasonic dealer, quoting the model number and serial number (both found on the rear of the TV).

	Problem	Actions
Screen	“Press any button to return” moves on the screen	<ul style="list-style-type: none"> ● The function to prevent “Image retention” is activated. (Not a faulty symptom) ● The screen saver is activated if the TV unit is not operated for a certain time in SD mode. ● “Image retention” (p. 7)
	Some spots remain bright or dark	<ul style="list-style-type: none"> ● The Plasma panel is made up of a few million pixels and is produced with advanced technology through an intricate process. Sometimes a few pixels may be bright or dark. These pixels do not indicate a defective panel and will have no impact on the performance of the TV.
	Chaotic image, noisy	<ul style="list-style-type: none"> ● Check nearby electrical products. (car or motorcycle ignition systems, fluorescent lamp, etc.)
	No image can be displayed	<ul style="list-style-type: none"> ● Check Picture menu (p. 28) ● Check the cable connections. (p. 11-14) ● Check that the correct input has been selected. (p. 24)
	Only spots are displayed instead of images	<ul style="list-style-type: none"> ● Check the channel settings. (p. 40) ● Check the antenna cables.
	Neither image nor sound is produced	<ul style="list-style-type: none"> ● Is the AC power cord plugged into the outlet? ● Is the TV unit turned On? ● Check Picture menu (p. 28) and volume. ● Check the AV cable connections. (p. 11-14) ● Check that the correct input has been selected. (p. 24)
	Black Box appears	<ul style="list-style-type: none"> ● Change settings of Closed Caption (CC). (p. 42)
Sound	No sound is produced	<ul style="list-style-type: none"> ● Are the speakers' cables connected correctly? (p. 45) ● Is “Sound Mute” active? (p. 15) ● Is the volume set to the minimum? ● Is “TV speakers” set to “Off”? (p. 28) ● Change “SAP” settings. (p. 19) ● Check “HDMI 1 in” or “HDMI 2 in” settings. (p. 28)
	Sound is unusual	<ul style="list-style-type: none"> ● Set “SAP” setting to “Stereo” or “Mono”. ● Check the HDMI device connected to the unit. ● Set the audio setting of the HDMI device to “Linear PCM”. ● If digital sound connection has a problem, select analog sound connection.
	Unknown sound heard 1- Sounds from TV cabinet 2- Whirring sound 3- Tick/Click sound 4- Buzzing sound	<ol style="list-style-type: none"> 1- Changes in the temperature and humidity of the room may cause the TV's cabinet to expand or contract and produce metallic sounds. This is not a sign of faulty operation or a malfunction. 2- The TV may have a cooling fan that makes a soft whirl. This is not a sign of faulty operation or a malfunction. 3- When the TV is powered on, an electrical component in the TV activates producing a tick/click sound. This is not a sign of faulty operation or a malfunction. 4- Electrical circuits are active while the TV set is on. This is not a sign of faulty operation or a malfunction.

Specifications

		TC-42PX14	TC-50PX14
Power Source		AC 120 V, 60 Hz	
Power Consumption	Maximum	286 W	399 W
	Standby condition	0.3 W	0.3 W
Plasma Display panel	Drive method	AC type	
	Aspect Ratio	16:9	
	Visible screen size (W × H × Diagonal)	42" class (41.6 inches measured diagonally) 36.2" × 20.4" × 41.6" (921 mm × 518 mm × 1,057 mm)	50" class (49.9 inches measured diagonally) 43.5" × 24.4" × 49.9" (1,106 mm × 622 mm × 1,269 mm)
	(No. of pixels)	786,432 (1,024 (W) × 768 (H)) [3,072 × 768 dots]	1,049,088 (1,366 (W) × 768 (H)) [4,098 × 768 dots]
Sound	Audio Output 20 W [10 W + 10 W] (10 % THD)		
PC signals		VGA, SVGA, XGA, WXGA, SXGA Horizontal scanning frequency 31 - 69 kHz Vertical scanning frequency 59 - 86 Hz	
Channel Capability (Digital/Analog)		VHF/ UHF: 2 - 69, CATV: 1 - 135	
Operating Conditions		Temperature: 32 °F – 104 °F (0 °C – 40 °C) Humidity: 20 % – 80 % RH (non-condensing)	
Connection Terminals	VIDEO IN 1	VIDEO: RCA PIN Type × 1 1.0 V [p-p] (75 Ω) S-VIDEO: Mini DIN 4-pin Y: 1.0 V [p-p] (75 Ω) C: 0.286 V [p-p] (75 Ω) AUDIO L-R: RCA PIN Type × 2 0.5 V [rms]	
	VIDEO IN 2	VIDEO: RCA PIN Type × 1 1.0 V [p-p] (75 Ω) AUDIO L-R: RCA PIN Type × 2 0.5 V [rms]	
	COMPONENT IN 1-2	Y: 1.0 V [p-p] (including synchronization) Pb, Pr: ±0.35 V [p-p] AUDIO L-R: RCA PIN Type × 2 0.5 V [rms]	
	HDMI 1-2	TYPE A Connector × 2 • This TV supports "HDAVI Control 4" function.	
	PC	D-SUB 15PIN: R,G,B / 0.7 V [p-p] (75 Ω) HD, VD / 1.0 - 5.0 V [p-p] (high impedance)	
	Card slot	SD CARD slot × 1	
	DIGITAL AUDIO OUT	PCM / Dolby Digital, Fiber Optic	
FEATURES		3D Y/C FILTER CLOSED CAPTION V-Chip Photo Viewer HDAVI Control 4	
Dimensions (W × H × D)	Including pedestal	40.6" × 28.0" × 12.9" (1,029 mm × 709 mm × 327 mm)	48.0" × 32.4" × 15.3" (1,218 mm × 822 mm × 387 mm)
	TV Set only	40.6" × 26.1" × 3.8" (4.2") (1,029 mm × 661 mm × 94 mm (106 mm))	48.0" × 30.3" × 3.8" (4.2") (1,218 mm × 769 mm × 94 mm (106 mm))
Mass	Including pedestal	61.8 lb. (28.0 kg)	79.4 lb. (36.0 kg)
	TV Set only	57.4 lb. (26.0 kg)	75.0 lb. (34.0 kg)

[TC-42PX14]

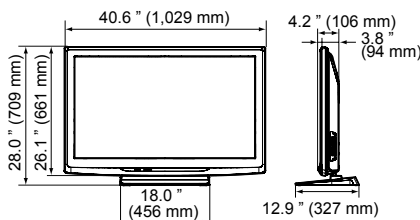

[TC-50PX14]

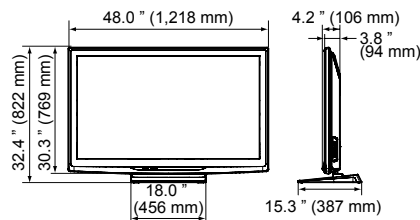

Note

• Design and Specifications are subject to change without notice. Mass and Dimensions shown are approximate.

Limited Warranty (for U.S.A. and Puerto Rico only)

PANASONIC CONSUMER ELECTRONICS COMPANY,
DIVISION OF
PANASONIC CORPORATION OF NORTH AMERICA
One Panasonic Way
Secaucus, New Jersey 07094

Panasonic Plasma Television Limited Warranty

Limited Warranty Coverage

If your product does not work properly because of a defect in materials or workmanship, Panasonic Consumer Electronics Company (referred to as "the warrantor") will, for the length of the period indicated on the chart below, which starts with the date of original purchase ("Limited Warranty period"), at its option either (a) repair your product with new or refurbished parts, or (b) replace it with a new or a refurbished product. The decision to repair or replace will be made by the warrantor.

PLASMA TV CATEGORIES	PARTS	LABOR	SERVICE
Up to 37" (diagonal)	1 (ONE) YEAR	1 (ONE) YEAR	Carry-In
42" (diagonal) and larger			On-Site

During the "Labor" Limited Warranty period there will be no charge for labor. During the "Parts" Limited Warranty period, there will be no charge for parts.

You must carry-in your product or arrange for on-site service during the Limited Warranty period. If non-rechargeable batteries are included, they are not warranted. This Limited Warranty only applies to products purchased and serviced in the United States or Puerto Rico. This Limited Warranty is extended only to the original purchaser and only covers product purchased as new. A purchase receipt or other proof of the original purchase date is required for Limited Warranty service.

On-Site or Carry-in Service

For On-Site or Carry-In Service in the United States and Puerto Rico call 1-877-95-VIERA (1-877-958-4372).

On-site service where applicable requires clear, complete and easy access to the product by the authorized servicer and does not include removal or re-installation of an installed product. It is possible that certain on-site repairs will not be completed on-site, but will require that the product or parts of the product, at the servicer's discretion be removed for shop diagnosis and/or repair and then returned.

Limited Warranty Limits And Exclusions

This Limited Warranty ONLY COVERS failures due to defects in materials or workmanship, and DOES NOT COVER normal wear and tear or cosmetic damage, nor does it cover markings or retained images on the glass panel resulting from viewing fixed images (including, among other things, non-expanded standard 4:3 pictures on wide screen TV's, or onscreen data in a stationary and fixed location). The Limited Warranty ALSO DOES NOT COVER damages which occurred in shipment, or failures which are caused by products not supplied by the warrantor, or failures which result from accidents, misuse, abuse, neglect, bug infestation, mishandling, misapplication, alteration, faulty installation, set-up adjustments, misadjustment of consumer controls, improper maintenance, power line surge, lightning damage, modification, or commercial use (such as in a hotel, office, restaurant, or other business), rental use of the product, service by anyone other than a Factory Service Center or other Authorized Servicer, or damage that is attributable to acts of God.

THERE ARE NO EXPRESS WARRANTIES EXCEPT AS LISTED UNDER "LIMITED WARRANTY COVERAGE". THE WARRANTOR IS NOT LIABLE FOR INCIDENTAL OR CONSEQUENTIAL DAMAGES RESULTING FROM THE USE OF THIS PRODUCT, OR ARISING OUT OF ANY BREACH OF THIS LIMITED WARRANTY. (As examples, this excludes damages for lost time, cost of having someone remove or re-install an installed unit if applicable, or travel to and from the servicer. The items listed are not exclusive, but are for illustration only.) **ALL EXPRESS AND IMPLIED WARRANTIES, INCLUDING THE LIMITED WARRANTY OF MERCHANTABILITY, ARE LIMITED TO THE PERIOD OF THE LIMITED WARRANTY.**

Some states do not allow the exclusion or limitation of incidental or consequential damages, or limitations on how long an implied Limited Warranty lasts, so the exclusions may not apply to you.

This Limited Warranty gives you specific legal rights and you may also have others rights which vary from state to state. If a problem with this product develops during or after the Limited Warranty period, you may contact your dealer or Service Center. If the problem is not handled to your satisfaction, then write to the warrantor's Consumer Affairs Department at the addresses listed for the warrantor.

PARTS AND SERVICE (INCLUDING COST OF AN ON-SITE SERVICE CALL, WHERE APPLICABLE) WHICH ARE NOT COVERED BY THIS LIMITED WARRANTY ARE YOUR RESPONSIBILITY.

● Limited Warranty (for U.S.A. and Puerto Rico only)
● Specifications

FAQs, etc.

Customer Services Directory (for U.S.A. and Puerto Rico)

Customer Services Directory (United States and Puerto Rico)

Obtain Product Information and Operating Assistance; locate your nearest Dealer or Service Center; purchase Parts and Accessories; or make Customer Service and Literature requests by visiting our Web Site at:

<http://www.panasonic.com/help>

or, contact us via the web at:

<http://www.panasonic.com/contactinfo>

You may also contact us directly at:

1-877-95-VIERA (958-4372)

Monday-Friday 9 am-9 pm; Saturday-Sunday 10 am-7 pm, EST.

■ For hearing or speech impaired TTY users, TTY: 1-877-833-8855

Accessory Purchases (United States and Puerto Rico)

Purchase Parts, Accessories and Instruction Books on line for all Panasonic Products by visiting our Web Site at:

<http://www.pstc.panasonic.com>

or, send your request by E-mail to:

npcparts@us.panasonic.com

You may also contact us directly at:

1-800-332-5368 (Phone) 1-800-237-9080 (Fax Only) (Monday - Friday 9 am to 9 pm, EST.)

Panasonic Service and Technology Company

20421 84th Avenue South,

Kent, WA 98032

(We Accept Visa, MasterCard, Discover Card, American Express, and Personal Checks)

■ For hearing or speech impaired TTY users, TTY: 1-866-605-1277

Limited Warranty (for Canada)

Panasonic Canada Inc.

PANASONIC PRODUCT - LIMITED WARRANTY

Panasonic Canada Inc. warrants this product to be free from defects in material and workmanship and agrees to remedy any such defect for a period as stated below from the date of original purchase.

Viera TV (42" & over)	In-home service	One (1) year, parts (including panel) and labour.
Viera TV (under 42")	Carry-in service	One (1) year, parts (including panel) and labour.

In-home Service will be carried out only to locations accessible by roads and within 50 km of an authorized Panasonic service facility.

LIMITATIONS AND EXCLUSIONS

This warranty does not apply to products purchased outside Canada or to any product which has been improperly installed, subjected to usage for which the product was not designed, misused or abused, damaged during shipping, or which has been altered or repaired in any way that affects the reliability or detracts from the performance, nor does it cover any product which is used commercially. Dry cell batteries are also excluded from coverage under this warranty.

This warranty is extended to the original end user purchaser only. A purchase receipt or other proof of date of original purchase is required before warranty service is performed.

THIS EXPRESS, LIMITED WARRANTY IS IN LIEU OF ALL OTHER WARRANTIES, EXPRESS OR IMPLIED, INCLUDING ANY IMPLIED WARRANTIES OF MERCHANTABILITY AND FITNESS FOR A PARTICULAR PURPOSE. IN NO EVENT WILL PANASONIC CANADA INC. BE LIABLE FOR ANY SPECIAL, INDIRECT OR CONSEQUENTIAL DAMAGES.

In certain instances, some jurisdictions do not allow the exclusion or limitation of incidental or consequential damages, or the exclusion of implied warranties, so the above limitations and exclusions may not be applicable.

In-home service requires clear, complete and easy access to the product by the Authorized Servicentre and does not include removal or re-installation of an installed product. If removal is required to service the product, it will be at the discretion of the Servicentre and in no event will Panasonic Canada Inc. or the Servicentre be liable for any special, indirect or consequential damages.

WARRANTY SERVICE

For product operation and information assistance, please contact:

Our Customer Care Centre: 1-800 #: 1-866-330-0014
Email link: www.vieraconcierge.ca

FOR PRODUCT REPAIRS, please contact Viera Customer Care Agent using the above contact info.

IF YOU SHIP THE PRODUCT TO A SERVICENTRE

Carefully pack and send prepaid, adequately insured and preferably in the original carton. Include details of the defect claimed, and proof of date of original purchase.

● Customer Services Directory (for U.S.A. and Puerto Rico) ● Limited Warranty (for Canada)

FAQs, etc.

Customer's Record

The model number and serial number of this product can be found on its back cover. You should note this serial number in the space provided below and retain this book, plus your purchase receipt, as a permanent record of your purchase to aid in identification in the event of theft or loss, and for Warranty Service purposes.

Model Number _____

Serial Number _____

Anotación del cliente

El modelo y el número de serie de este producto se encuentran en su panel posterior. Deberá anotarlos en el espacio provisto a continuación y guardar este manual, más el recibo de su compra, como prueba permanente de su adquisición, para que le sirva de ayuda al identificarlo en el caso de que le sea sustraído o lo pierda, y también para disponer de los servicios que le ofrece la garantía.

Modelo _____

Número de serie _____

Panasonic Consumer Electronics Company,
Division of Panasonic Corporation of North America
One Panasonic Way, Secaucus
New Jersey 07094 U.S.A.

Panasonic Canada Inc.
5770 Ambler Drive
Mississauga, Ontario
L4W 2T3 CANADA