

Panasonic

Colour Television

TC-29A11Z

TC-29R20

TC-29R21Z

Operating Instructions

Please read these operating instructions completely before operating this set and retain the booklet for future reference.

TQB4A0090

Index

Location of the Television Controls	2
Antenna and A/V Connections	3
Remote Control Buttons & Battery Replacement	4
General Operation of the Television	5
Remote Control Operation of the Television	6
Tuning Procedure	7
AFC (Automatic Frequency Control)	8
Programme Number Skip Function	9
Warnings and Cautions	10
Troubleshooting	10
Specifications	11
Customer's Record	12

Control Panel See Page 5

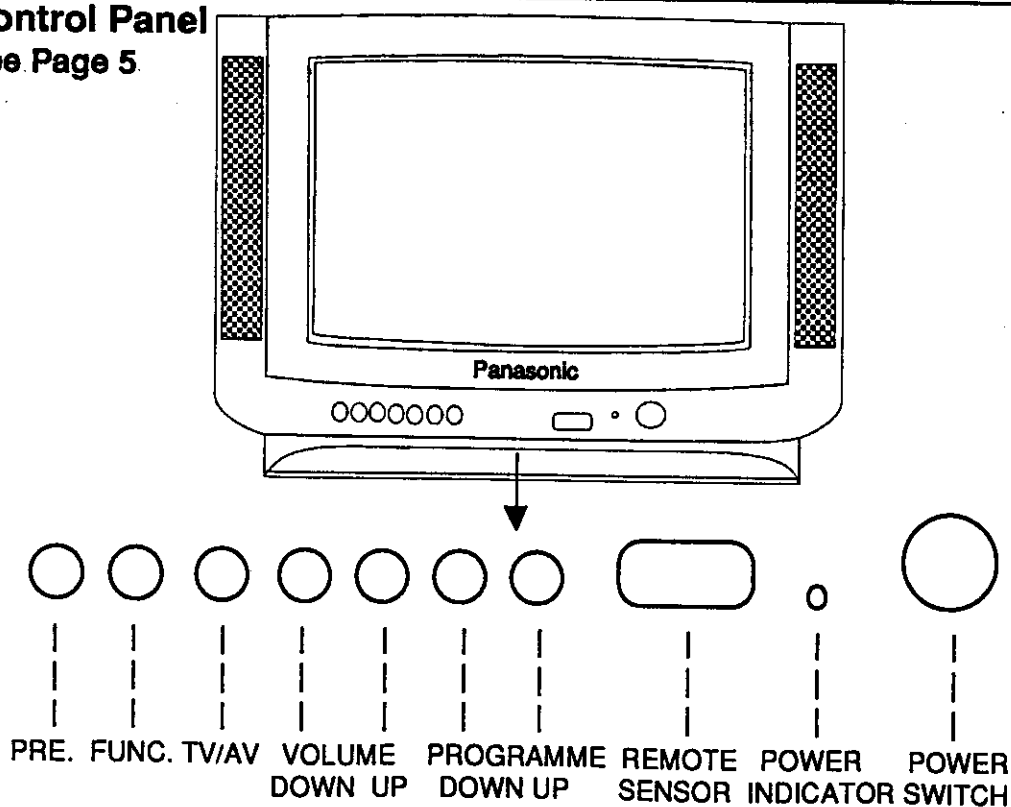

Antenna and A/V Connections

Connect the Aerial Cable to the RF In Terminal

The Aerial Input (RF-IN) impedance of this television is 75Ω. If your aerial lead is 300Ω ribbon (two wires separated by a flat plastic sheet) you will require a 300Ω/75Ω Balun in order to connect your aerial to the television.

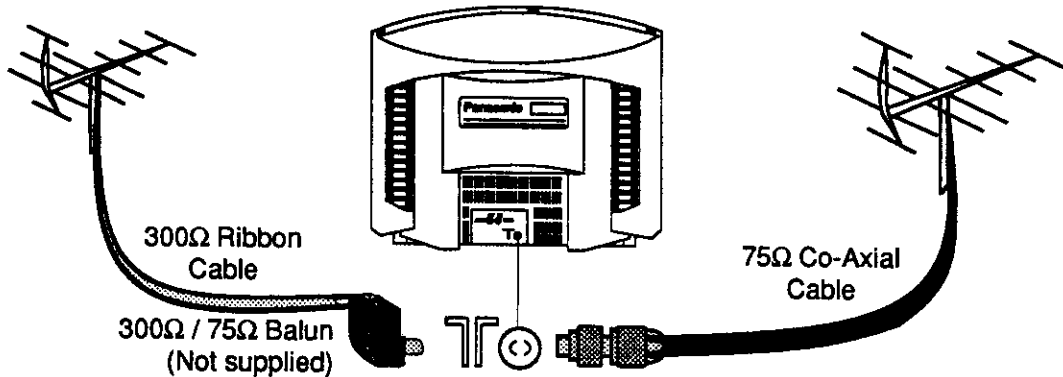

For your safety any external aerial should be installed by a reputable qualified installer and should comply with Australian Standard AS1417.1.

Watching a Picture from a VCR

The television can be tuned to the VCR (follow the tuning procedure on page 7) but a better picture and sound quality can be achieved by connecting the VCR to the AUDIO INPUT and VIDEO INPUT terminals at the rear of the TV.

The Aerial cable must be connected for normal viewing.

Press the TV/AV selection button. Set the VCR to playback mode. To watch, or return to, the TV programme, press the TV/AV selection button again.

TC-29R20 and TC-29R21Z A/V (Audio / Video) Connections

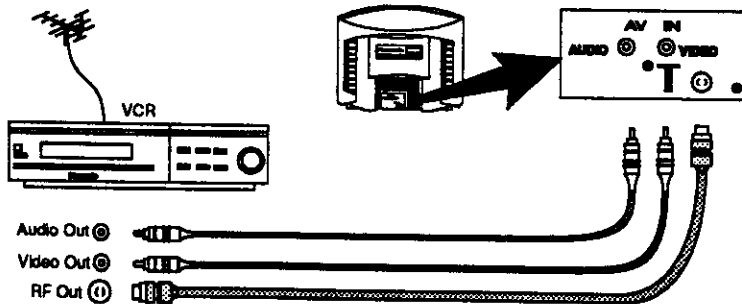

TC-29A11Z A/V (Audio / Video) Connections

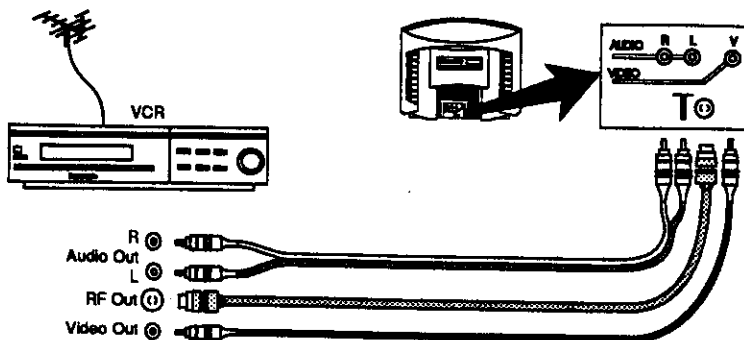

Connecting a signal to the right audio input socket will automatically switch the television to AV Stereo.

A Mono VCR should have the Audio out connected to the TV left Audio Input only.

Remote Control

Battery Replacement

Open the Rear Cover

A slight downward pressure on the battery cover will ensure easy removal.

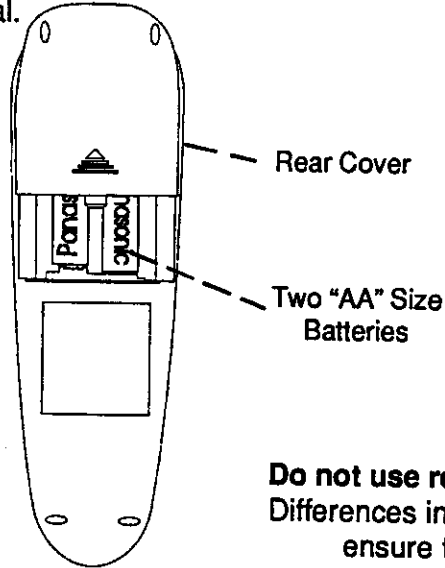

Replace the Batteries

(Use "AA" size batteries only.)

Insert the batteries according to the corresponding "+" and "-" symbols on both the batteries and inside the Battery compartment. Replace the Rear Cover.

Do not use rechargeable (Ni-Cad) batteries.
Differences in shape and performance may fail to ensure the correct operation.

Remote Control

See Page 6

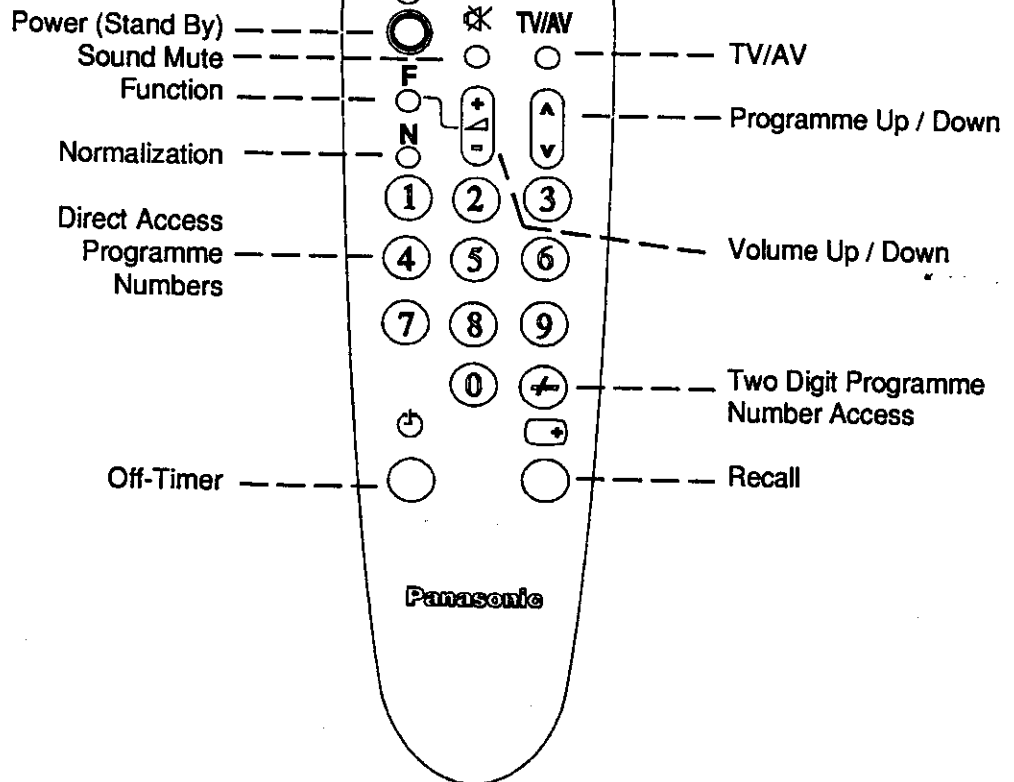

General Operations

1. Power Switch

Press to switch the TV set ON. To switch OFF press it again.

2. PRE. Button

The Pre stands for Preset and this button is used for tuning, AFC setting and Skip function setting.

3. Function (FUNC.) Button

Press this button to display the functions listed below :

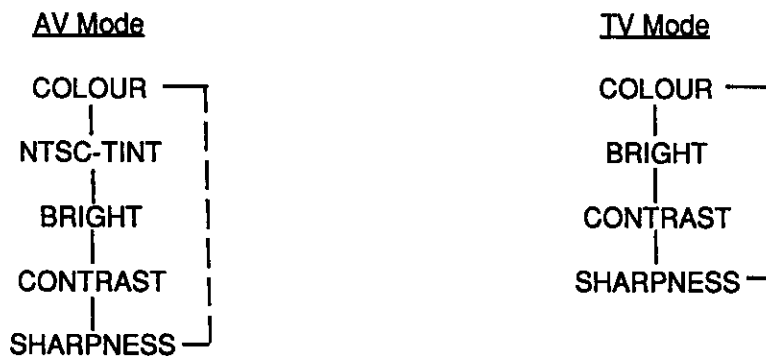

As each item is displayed press the Volume Up (+) or Volume Down (-) buttons to adjust the level of COLOUR, NTSC-TINT, BRIGHT, CONTRAST and SHARPNESS.

Note:

NTSC-TINT appears only if AV Mode is selected.

4. TV/AV Selection Button

Press the TV/AV button to select either TV mode or AV mode.

5. Volume Up and Down Button

Press these buttons to adjust the sound level.

6. Programme Number Up and Down Buttons

Press these buttons to select the next higher or lower Programme Number.

Remote Control Transmitter Operations

1. TV/AV Selection Button

Press to select either TV mode or AV mode.

2. Programme Number Up and Down Buttons

Press these buttons to select the next higher or lower Programme Number.

3. Volume Up and Down Buttons

Press these buttons to adjust the sound level.

4. Direct Programme Number Selection Buttons.

To select a Programme Number between 0 and 9 press the desired number.

5. Two Digit Programme Number Selection Button.

To directly access Programme Numbers above 9 first press the - / - - button followed by the two digits required.

For example: to select channel 12

1. Press the - / - - button
2. Press the 1 button
3. Press the 2 button



6. Recall Button

This button can be used to display the current Programme Number and the Off-Timer setting.

Pressing the button again removes the display from the screen.

NOTE: Do not leave the TV in Stand By mode for a long period of time. It is better to switch off when you are away.

7. Off-Timer

The TV set can be preset to switch off after a fixed period of time. The time is changed each time the button is pressed.

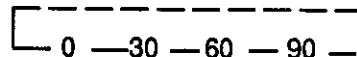

The timer can be reset by selecting the 0 position or by turning the TV OFF.

8. Normalization (N) Button

This button returns the COLOUR, NTSC TINT, BRIGHTNESS, CONTRAST and SHARPNESS to the factory preset levels. The on-screen indicators turn from green to yellow when at preset values.

9. Function (FUNC.) Button

Press this button to select the COLOUR, NTSC TINT, BRIGHTNESS, CONTRAST and SHARPNESS.

All functions can be adjusted using the Volume Up (+) and Volume Down (-) buttons.

10. Sound Mute Button

Press this button to mute the sound. To cancel the mute either press the Mute button again or one of the volume buttons.

11. Stand By Button

Press this button to put the TV into stand by mode. To switch the TV back ON press the Stand By button or the Programme Number Up or Down button or any direct access Programme Number Selection Button (0 ~ 9).

Tuning Procedure

NOTE:

This Television has been factory tuned to all the major capital city channels. Use this tuning procedure only if you wish to reset individual Programme Numbers.

1. Switch on the TV set.
2. Press the PRE. (Preset) button until the on-screen display appears as shown:

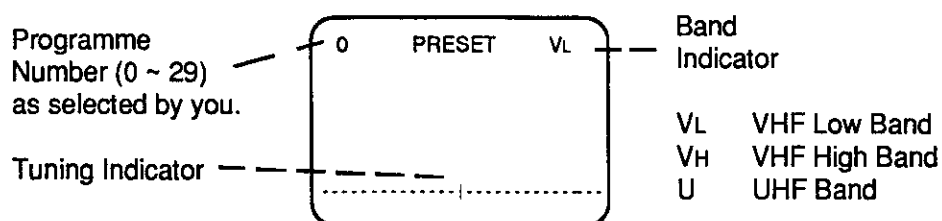

3. Press the Programme Up (\wedge) or Programme Down (\vee) button to select the required Programme Number.
4. Press the Volume Up (+) or Volume Down (-) button to tune to the next available channel. As long as the button is pressed, the indicator will appear on the screen showing that the TV is tuning.

When the picture is tuned to your satisfaction release the button.

Fast Tune It is possible to increase the tuning speed by pressing the TV/AV button at the same time. When nearing a broadcast station release the TV/AV button and continue with normal tuning.

5. To tune more stations repeat steps 3 and 4 until all channels are tuned. A maximum of 30 Programme Numbers (0 ~ 29) can be programmed.
6. Press the PRE. button 3 times to finish the tuning procedure. The picture will blank momentarily.

Fine Tuning

Please refer to page 8 - "AFC (Automatic Frequency Control) Function".

AFC (Automatic Frequency Control) Function

NOTE:

Under normal viewing conditions the AFC remains "ON". However in areas of poor reception or constant interference a slight adjustment to the tuning may improve the picture quality.

How to Set the AFC Off

1. Switch on the TV set.
2. Press the PRE. (Preset) Button 3 times. (The picture will go blank momentarily after the second press) The on-screen display will appear as shown:

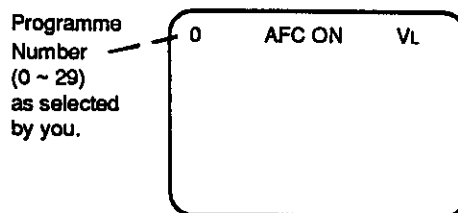

3. Press the Programme Up (\wedge) or Programme Down (\vee) button to select the required Programme Number.
4. Press the Volume Up (+) or Volume Down (-) button to turn the AFC Off.

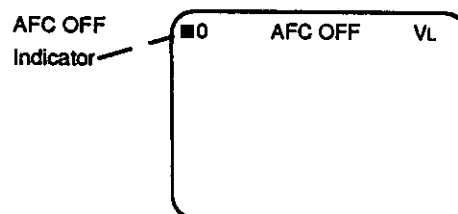

5. If more than one Programme Number is to be programmed with the AFC OFF function repeat steps 2, 3 and 4.
6. Press the PRE. button once to finalise the operation.
7. Follow the tuning procedure outlined on page 7 to "Fine Tune" the required Programme Number(s).

How to Reset the AFC Off

1. Switch on the TV set.
2. Press the PRE. (Preset) Button 3 times. (The picture will go blank momentarily after the second press) The on-screen display will appear as shown:

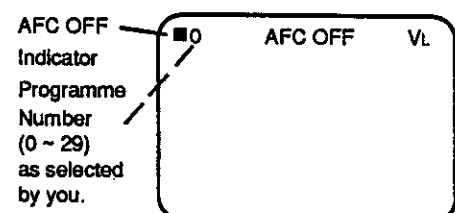

3. Press the Programme Up (\wedge) or Programme Down (\vee) button to select the required Programme Number.
4. Press the Volume Up (+) or Volume Down (-) button to turn the AFC On.

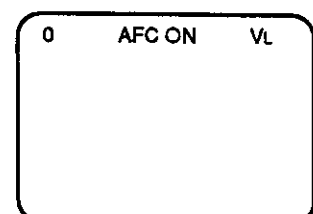

5. If more than one Programme Number is to be reset, repeat steps 2, 3 and 4.
6. Press the PRE. button once to finalise the operation.

Skip Operation

NOTE:

This option allows you to skip the unused or undesired Programme Numbers. The Function is only applicable when the Programme Number Up or Down buttons are pressed.

How to SET the Skip Operation

1. Switch on the TV set.
2. Press the PRE. (Preset) button twice. (The picture will blank momentarily).
The on-screen display appears as shown:

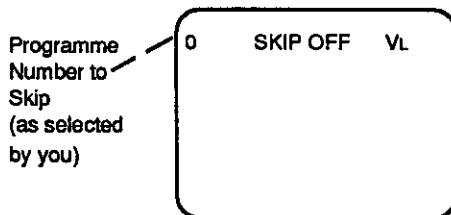

3. Press the Programme Number Up or Down button to select the Programme Number you want to skip.
4. Press the Volume Up or Volume Down button. The on-screen display will change as shown :

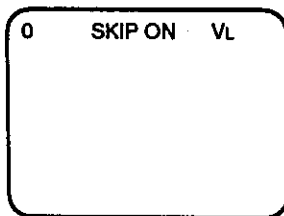

5. If you wish to skip any more Programme Numbers repeat steps 3 and 4.
6. Press the PRE. button twice to return the TV to normal operating mode.

How to CANCEL the Skip Operation

1. Switch on the TV set.
2. Press the PRE. (Preset) button twice. (The picture will blank momentarily).
The on-screen display appears as shown:

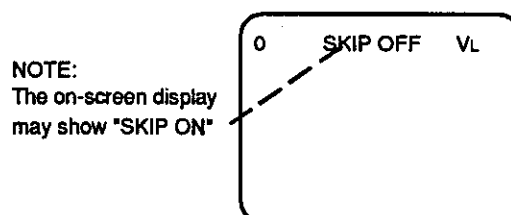



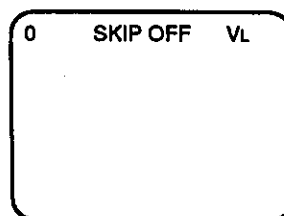







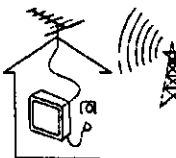
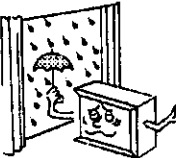

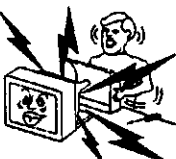

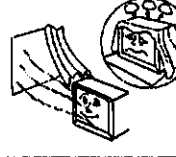

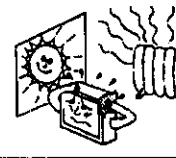
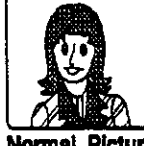
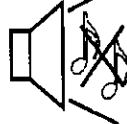

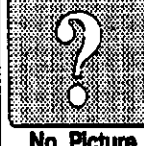
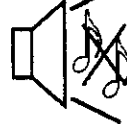
3. Press the Programme Number Up or Down button to select the Programme Number you want to skip.
4. Press the Volume Up or Volume Down button. The on-screen display will change as shown :

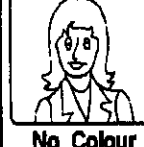

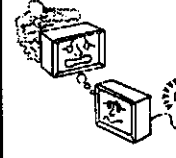
5. If you wish to skip any more Programme Numbers repeat steps 3 and 4.
6. Press the PRE. button twice to return the TV to normal operating mode.

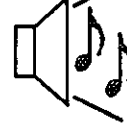
Warnings and Cautions

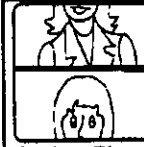
Troubleshooting

Warnings and Cautions		Picture	Sound	Check
 <p>Power Source and Broadcast System This Television will operate on 230V\pm 10% 50Hz - TC29A11Z 240V\pm 10% 50Hz - TC29R20 230V\pm 10% 50Hz - TC29R21Z It is designed exclusively for the PAL B broadcast system.</p>				
 <p>To prevent electric shock or damage do not expose this television to rain or excessive moisture. Do not place any containers which contain water on or near this Television.</p>	 <p>Snowy Picture</p>	 <p>Noisy Sound</p>		Aerial Location, Direction or Connections
 <p>Danger High Voltage: Do not remove the rear cover as High Voltage components will be exposed. Refer any Service to a Qualified Technician.</p>	 <p>Multiple Image</p>	 <p>Normal Sound</p>		Aerial Location, Direction or Connections
 <p>Adequate ventilation is essential to prevent premature failure of the television.</p>	 <p>Interference</p>	 <p>Noisy Sound</p>		Electrical Appliances, Cars, Motorcycles or Fluorescent Lamps
 <p>Avoid exposing the television to direct sunlight or any other sources of direct heat.</p>	 <p>No Picture</p>	 <p>No Sound</p>		Volume (Check the Remote Control Mute function) Receiving System Mode, refer to page 5
 <p>Remove the Power Plug from the wall socket when the Television is not going to be used for an extended period of time.</p>	 <p>No Picture</p>	 <p>No Sound</p>		Not Plugged in, Not switched On or Switched to Stand By. Check the Brightness, Contrast and Volume settings.
 <p>Cabinet and Picture Tube Care The cabinet and picture tube can be kept in good condition by wiping with a clean, soft cloth moistened with a mild detergent and water. Do Not use solutions containing petroleum or other chemicals. For safety, remove the plug from the power outlet when cleaning.</p>	 <p>No Colour</p>	 <p>Noisy Sound</p>		Colour Control. Receiving System Mode, refer to page 5
<p>Safety First In the advent of unusual operation (e.g. odd sounds, smoke or aromas), turn the television Off and remove the power cord from the wall socket. Then call the Television Service Centre; this may reduce the probability of extensive repair costs.</p> 	 <p>Scrambled</p>	 <p>Weak Sound</p>		Re-tune the Television.
	 <p>Colour Patches</p>	 <p>Normal Sound</p>		Magnetic Interference from unshielded equipment, the Television moved while "On". (Switch the Television Off for Ten minutes)
	 <p>Rolling Picture</p>	 <p>Noisy Sound</p>		Receiving System Mode, refer to page 5

Specifications

Tuneable RF Channels	TC-29R20 VHF 0 to 11 UHF 28 to 69	TC-29A11Z, TC29R21Z VHF 1 to 11 UHF 21 to 69	
Receiving System	1. PAL B/G Reception of Off air Broadcasts Playback from PAL Video Tape Recorders		
	<table border="1" style="width: 100%; border-collapse: collapse;"> <tr> <td style="width: 35%;">2. NTSC 4.43 3. NTSC 3.58 4. PAL 60Hz</td> <td>Playback from Special Video Tape Recorders and Special Video Disc Players only (Via the AV Sockets)</td> </tr> </table>		2. NTSC 4.43 3. NTSC 3.58 4. PAL 60Hz
2. NTSC 4.43 3. NTSC 3.58 4. PAL 60Hz	Playback from Special Video Tape Recorders and Special Video Disc Players only (Via the AV Sockets)		
Power Requirements	TC-29R20 TC-29A11Z & TC-29R21Z	240Volts \pm 10% 50Hz 230Volts \pm 10% 50Hz	
Power Consumption	130W (Max)	12W (Stand-by condition)	
Chassis	C150A		
Tuning System	Frequency synthesized, 30 Position		
Picture Tube	68cm Viewable (Measured diagonally) Deflection angle 110°		
Audio Output	Twin Internal 16 Ω Speakers: 2W + 2W, (10% THD) AV Stereo (TC-29A11Z Only): 2W per channel, (10% THD)		
Aerial Impedance	75 Ω Unbalanced coaxial		
Video Input	1.0Vp-p, 75 Ω		
Audio Input, AV Stereo	TC-29A11Z	400mV Approx. per channel (Selected automatically when a connector is plugged into the right Audio AV input socket.)	
	Mono TC-29R20, TC-29R21Z	400mV Approx.	
Accessories	EUR501310 Remote Control with 2 'AA' Batteries		
Dimensions	Width = 76.0cm, Depth = 46.0cm, Height = 57.6cm		
Weight	35kg		
Note:	Design and Specifications are subject to change without notice. Weight and Dimensions shown are approximate.		