

Panasonic

Colour Television

TC-59R62



TC-25L2Z

Operating Instructions

Please read these operating instructions completely before operating this set and retain the booklet for future reference.

TQB4A0071

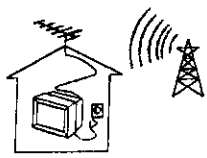
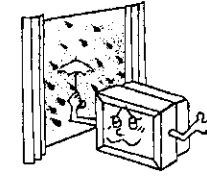
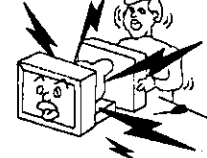
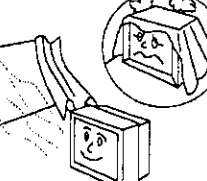
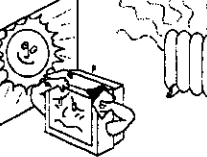
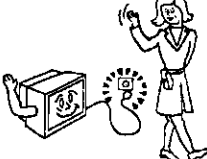
Warnings and Cautions

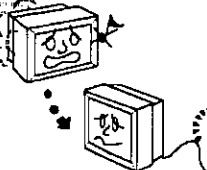
	<p>Power Source and Broadcast System This Television will operate on 240V± 10% 50Hz A.C. It is designed exclusively for the PAL B broadcast system.</p>
	<p>To prevent damage to the Television which may result in electric shock, do not expose this television to rain or excessive moisture. For safety do not place any containers which contain water on or near this Television.</p>
	<p>High Voltage: Do not remove the rear cover as High Voltage components will be exposed. Refer any Service to a Qualified Technician.</p>
	<p>Adequate ventilation is essential to prevent premature failure of any electrical component.</p>
	<p>Avoid exposing the Television to direct sunlight or any other sources of direct heat.</p>
	<p>When the Television is not being used for an extended period of time, remove the Power Plug from the wall socket.</p>
	<p>Cabinet and Picture Tube Care The cabinet and Picture tube can be kept in good condition by simply wiping with a clean, soft cloth moistened with mild detergent and water. Do Not use petroleum based solutions. For safety, remove the plug from the power outlet when cleaning.</p>
	<p>Safety First In the advent of unusual operation (e.g. odd sounds, smoke or aromas), turn the Television Off and remove the Power cord from the wall socket. Then call the Television Service Centre.</p>

Index

- Connecting your Television 4
- Battery Installation 5
- Antenna Connectors 5
- Remote Control 6
- Remote Control Functions 12,13
- General Operation 7 - 9
- Tuning 10, 11**
- Skip Operation 14
- AFC (Automatic Frequency Control) 15
- Troubleshooting 16
- Specifications 17

Pages 6, 12 & 13

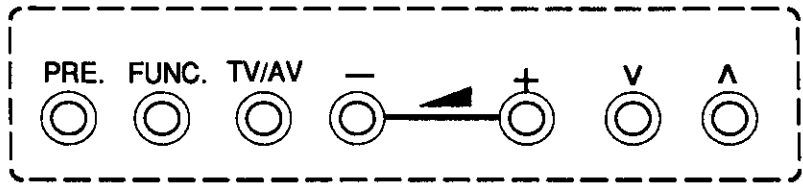
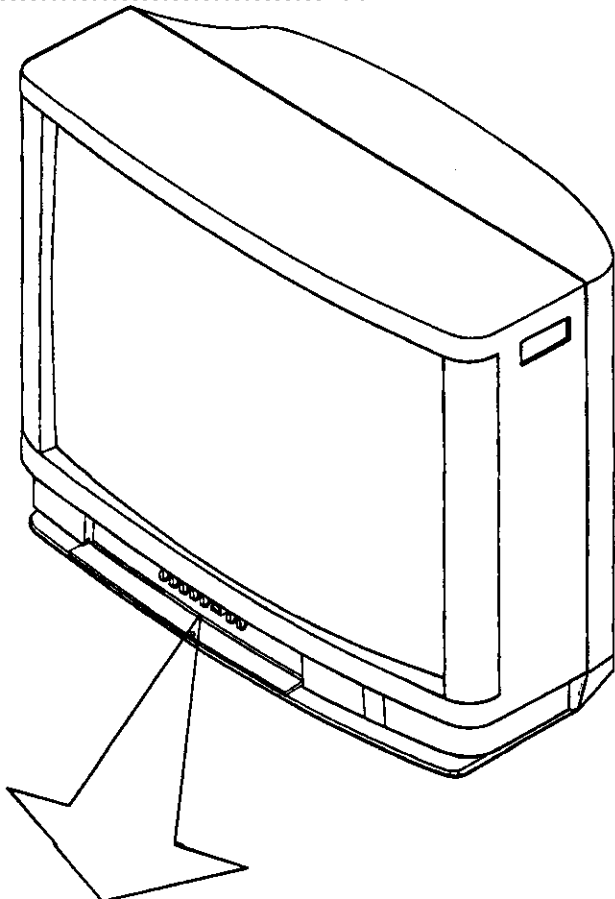
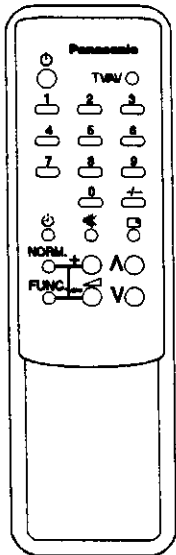

Pages 8 - 12 & 15

How to connect the Television

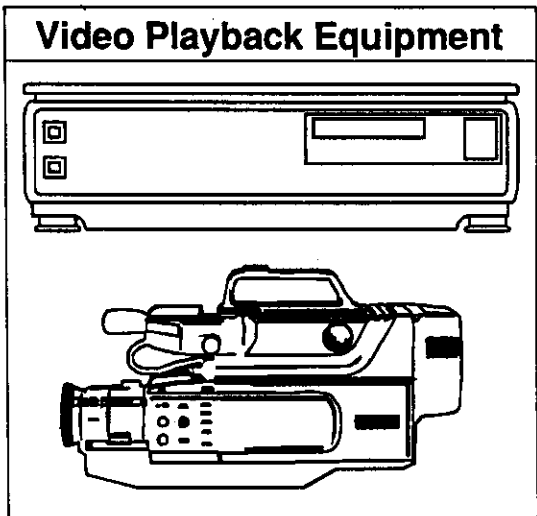
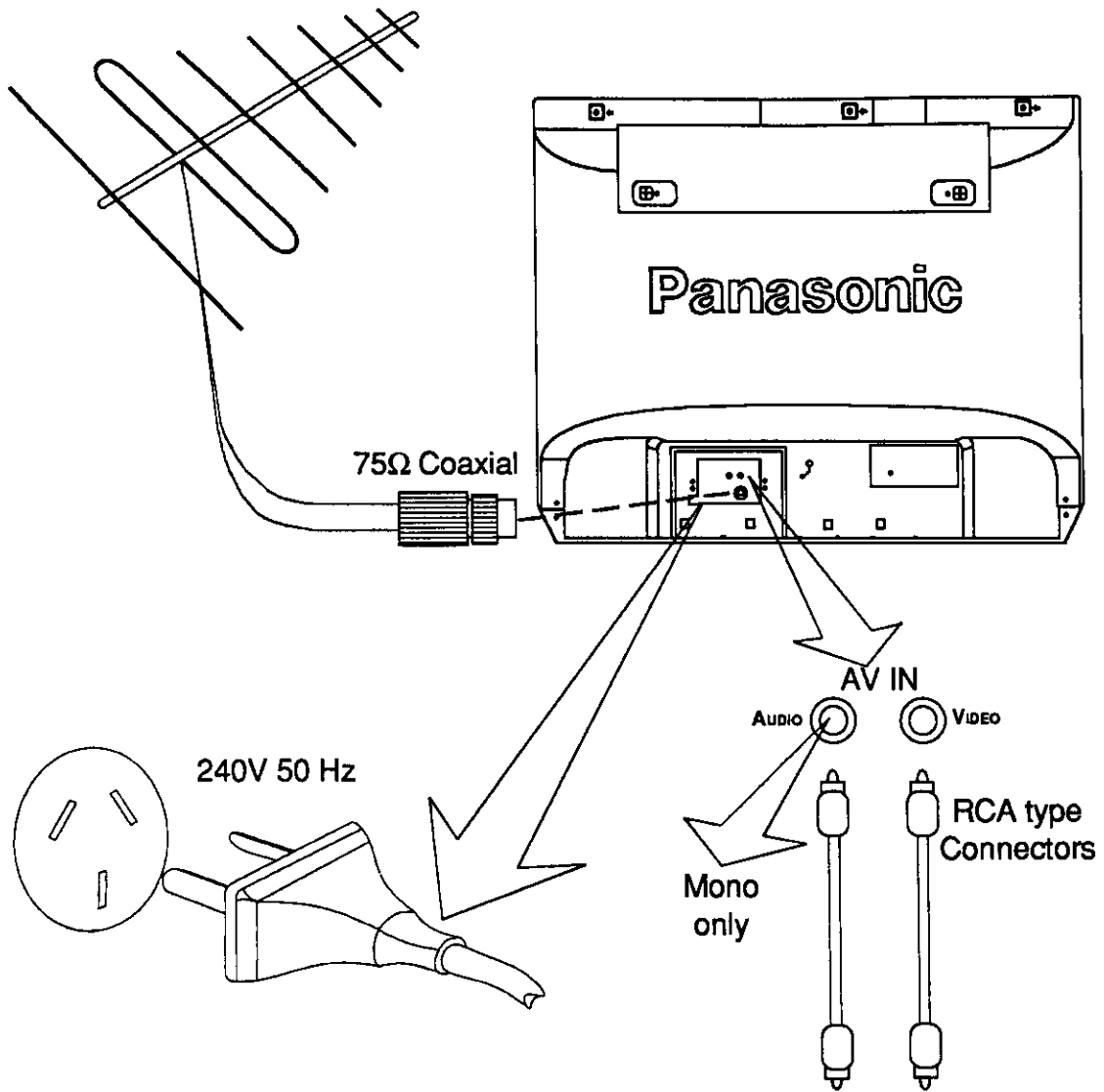

Battery Replacement (Type "AA")

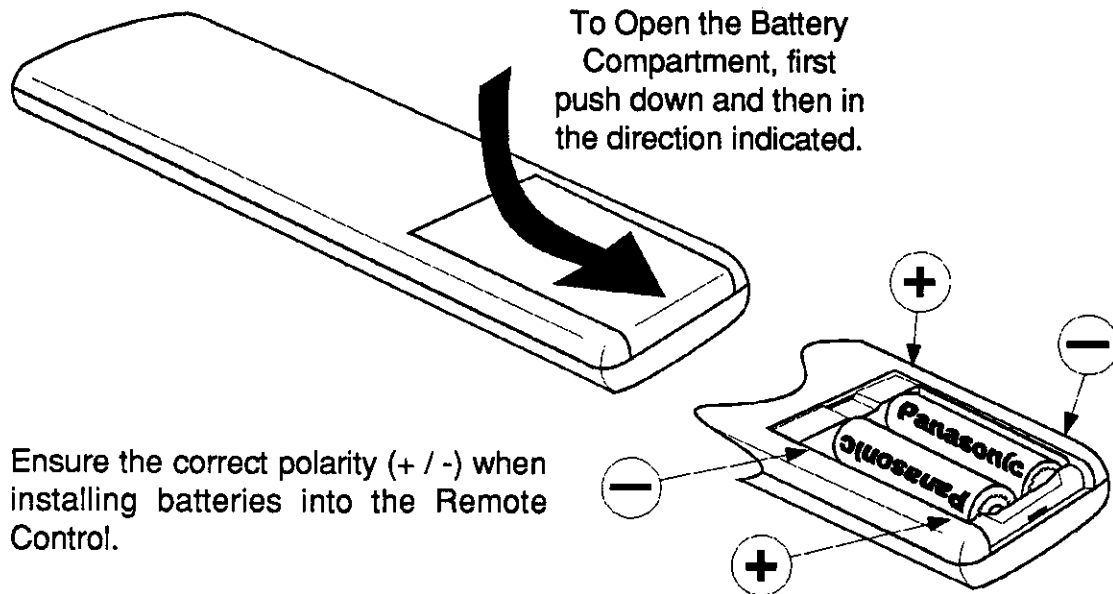

Caution:

The use of rechargeable batteries is not recommended.
Dispose of old batteries in a responsible manner.

Antenna Connector types

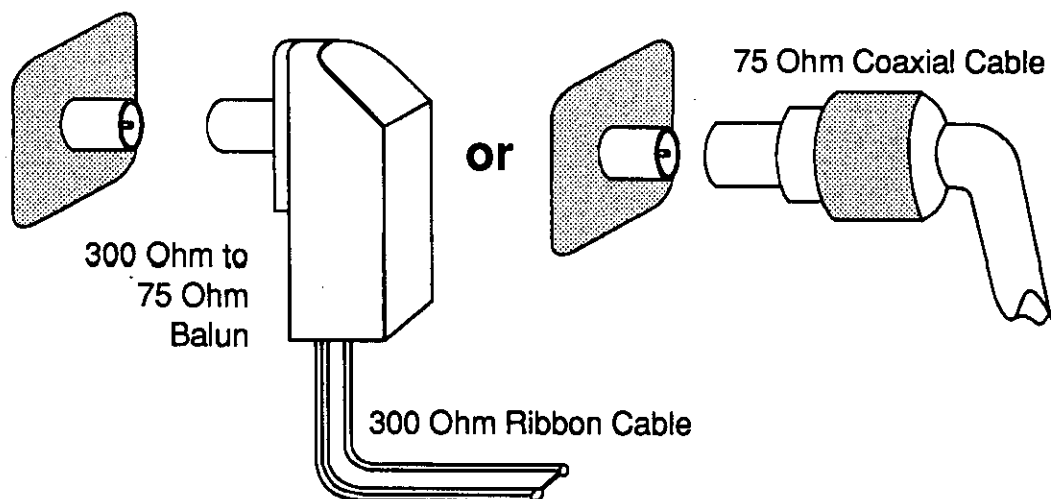

Remote Control Transmitter

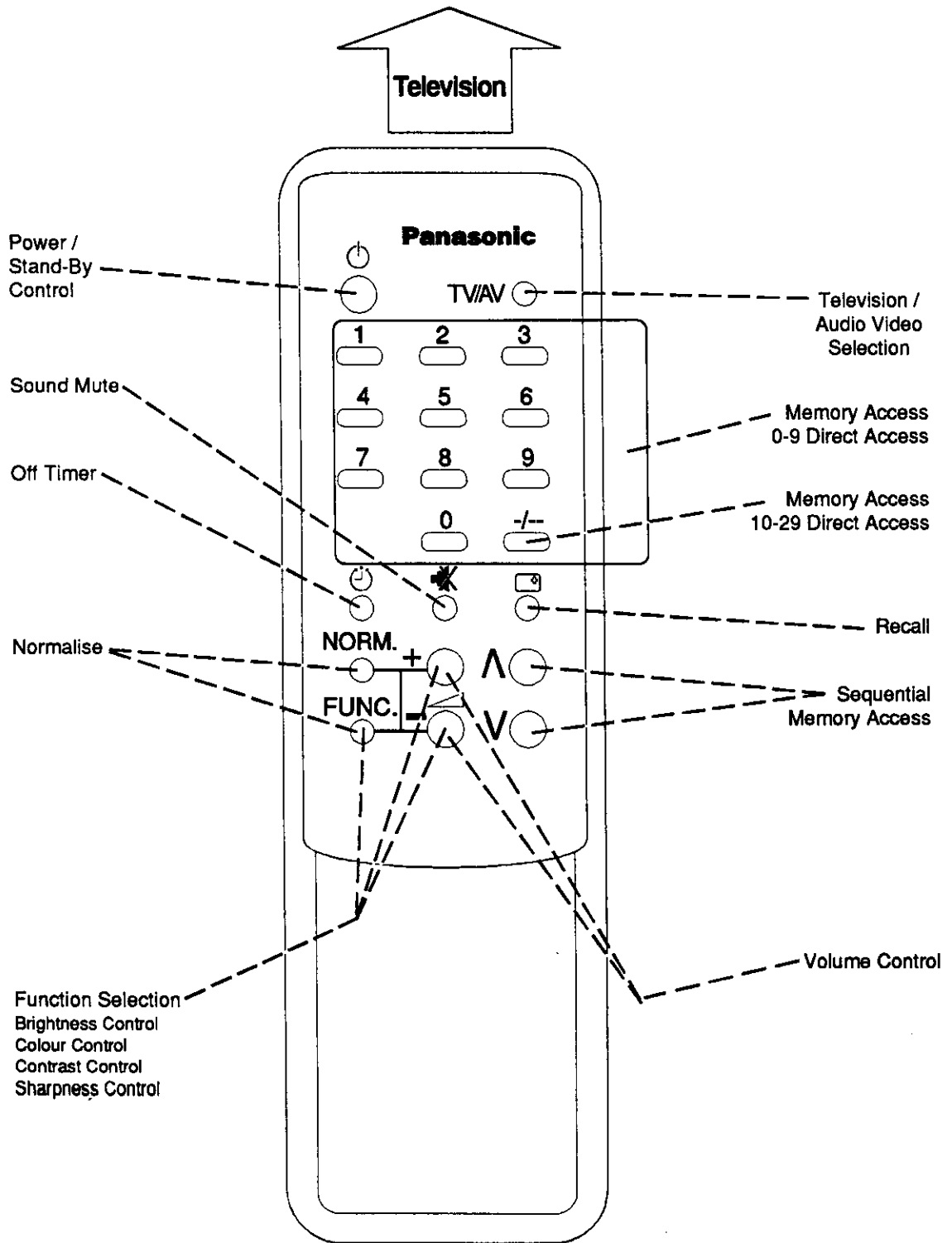

General Operation

Front Panel

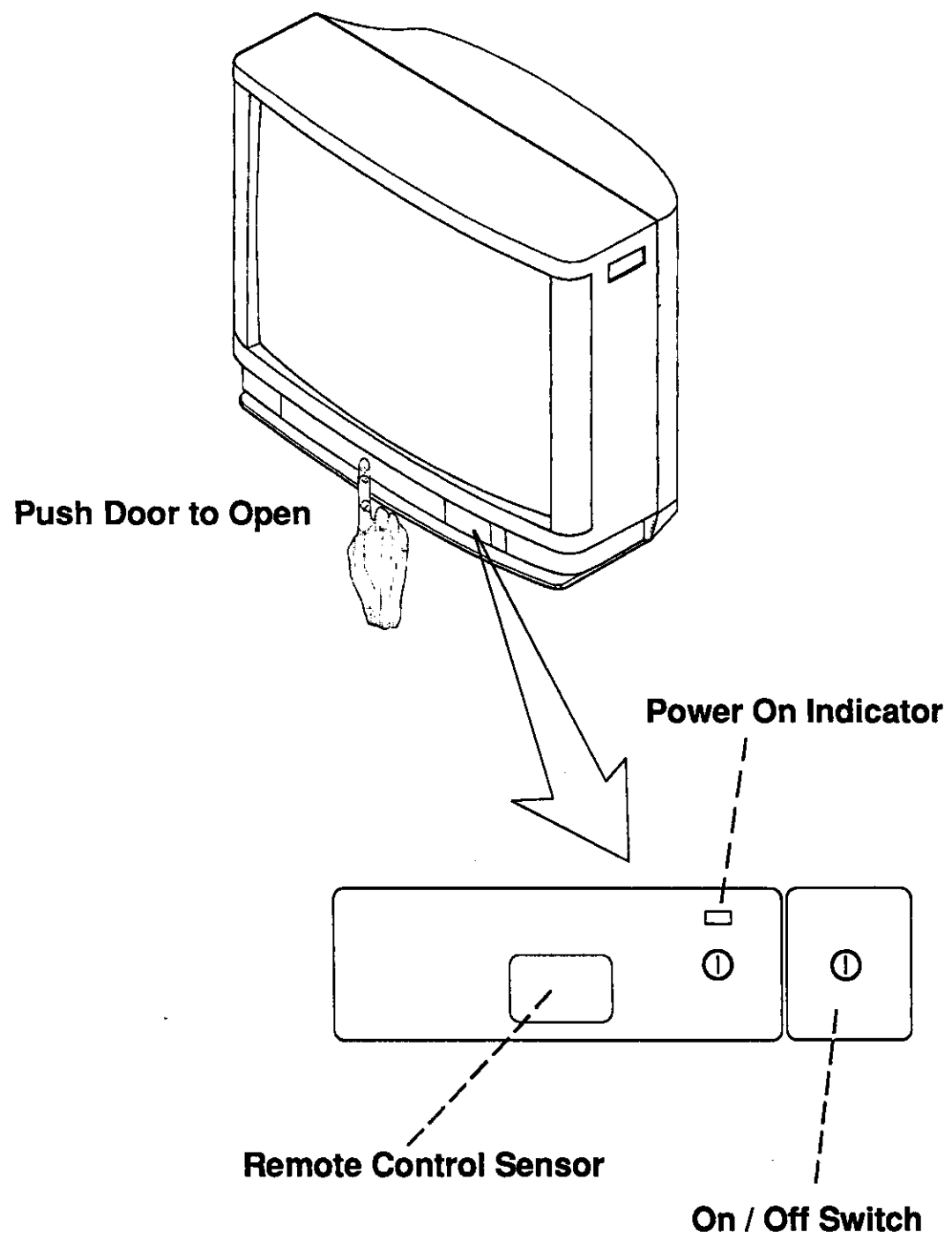

General Operation

Picture and Sound Controls

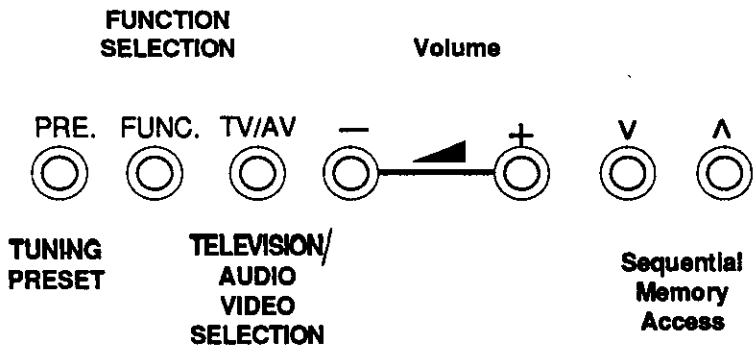
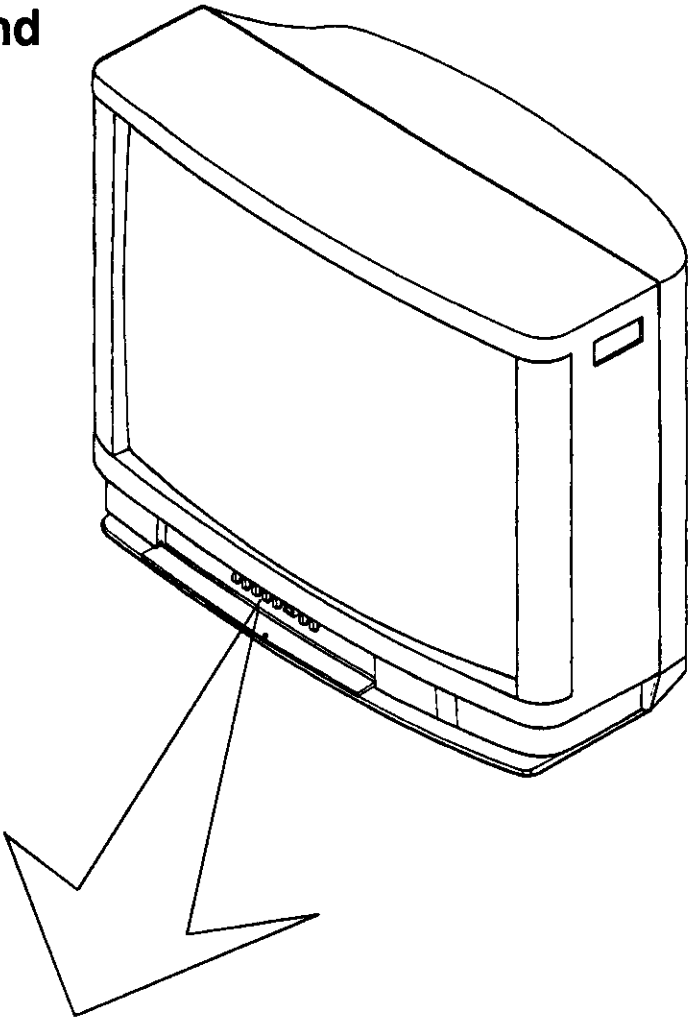

General Operation

Colour, Brightness, Contrast and Picture Sharpness Controls

Press the "FUNC." button. The On-Screen information will display either "COLOUR, BRIGHTNESS, CONTRAST or SHARPNESS". Pressing either the Volume "+" or "-" button while this is displayed adjusts the displayed levels accordingly. The minimum level of adjustment is 0 while the maximum level of adjustment = 63.

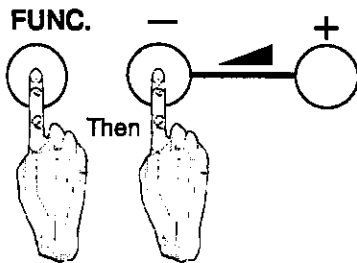
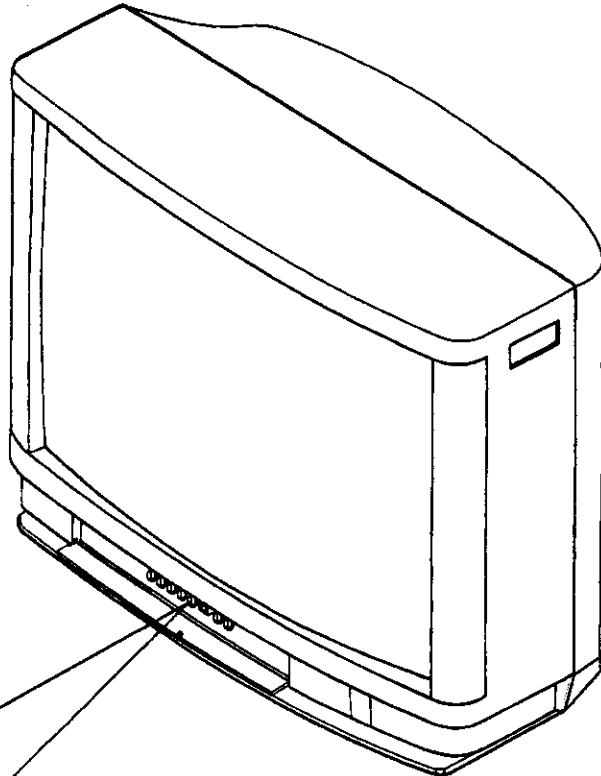

Note:
The On-Screen information will remain displayed for up to 5 seconds after selection and adjustment prior to returning to the normal viewing mode.

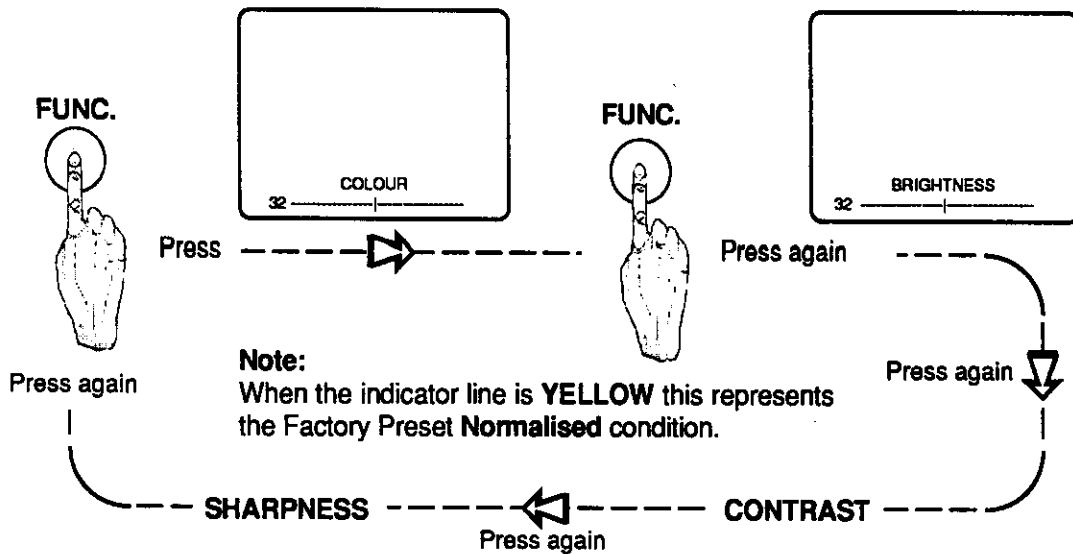

Tuning

Tuning Controls

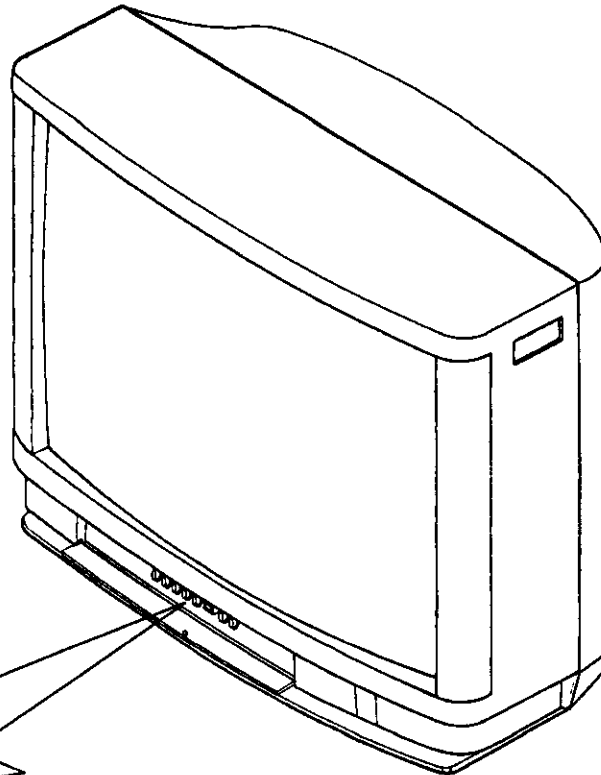

After pressing the PRE. button and entering the SEARCH mode, (refer to steps 1 through 6 on the next page) broadcast band selection is achieved in the following manner:

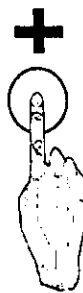
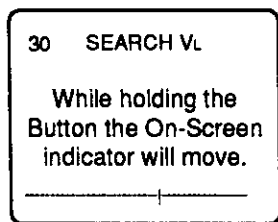
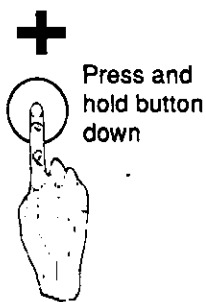

Continue pressing the button and the tuning will continue onto the next Band

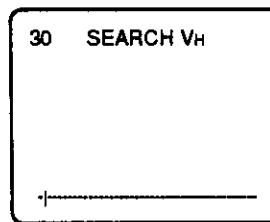

On-Screen Display	Broadcast Band	Television Broadcast Channel
VL	VHF Low	0 - 5
VH	VHF High	5A - 11
U	UHF	28 - 69

Tuning

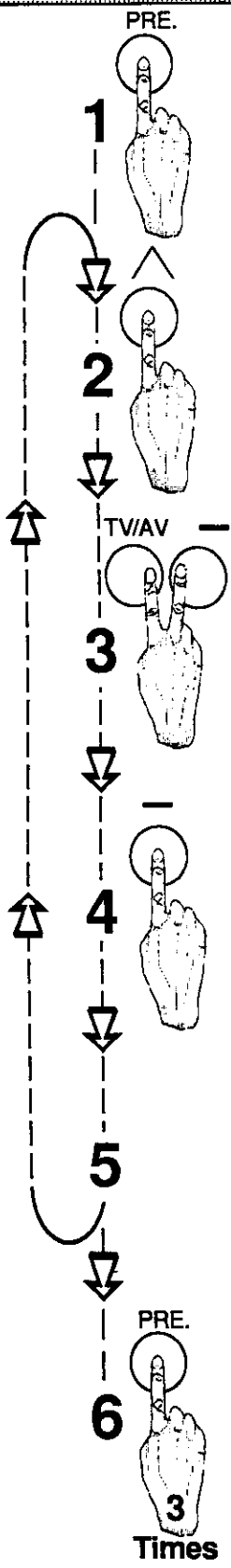

Press the "PRE." button.

The word **PRESET** followed by the characters **VH, VL** or **U** along with the memory location number will appear on the screen.

Select the desired Memory Location number (Channel).

Fast Tune by holding both buttons together. Hold until the desired television broadcast becomes visible.

- TV/AV & Volume "+"
= Fast tune UP

- TV/AV & Volume "-"
= Fast tune DOWN

Fine Tune by holding one tuning button. Ensure the best picture and sound information is available before proceeding further.

- Volume "+"
= Fine tune UP

- Volume "-"
= Fine tune DOWN

Repeat steps 2, 3 & 4 if more than one Memory Location requires tuning.

Press the "PRE." button **3** times to finalise the tuning process.

Note:
The PRE. button requires pressing 3 times from this position in the preset function to complete the tuning memory process and return to the normal viewing condition. If this is not done the television will remain in a preset mode until the television is switched off.

Remote Control

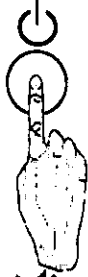

Power (Stand-By) Button.

Push this button to turn the receiver off (Stand-by).
Push again to turn On.

Note: Do not leave the Television in Stand-By for extended periods.



Sound Mute Button.

When activated, this will show the Mute Symbol in Red as an On-Screen display and reduce the sound level to minimum. Pressing the Mute button again, or the Volume + or - will return the volume to the original condition.



Volume Control.

Press the "+" button to increase the volume.
Press the "-" button to decrease the volume.

FUNC.



Colour Control.

Brightness Control.

Contrast Control.

Note: Normally Contrast is set at Maximum.

Sharpness Control.

The "FUNC," button on the Remote Control operates in the same principle as the "FUNC." button on the front control panel. Refer to page 9.

NORM.



Normalise Button.

Press this button while the On-Screen display remains after pressing the "FUNC." button to reset ALL of the Colour, Brightness, Contrast and Sharpness levels to the factory preset condition.

Remote Control

0~9 & -/--



TV/AV



Direct Memory Location access. Memory locations 0~9 are accessed by pressing the corresponding numbered button. For Memory Locations 10~29 First press the -/-- button then enter the First digit followed by the second digit.

Sequential Memory Location access.

^
Up

v
Down

TV/AV Selection.

An AV Signal may be connected through the AV terminals on the rear of the television.

Note: This button is found on both the Remote Control and on the Television Control Panel. (Refer to page 8)

Recall.

Pressing this button will display the current Memory Location. Press again to cancel the display.

Off Timer.

Press to select a preset time for the television to automatically turn off (Stand-By). The preset times are 30, 60 and 90 minutes.



Skip Function

This function makes it possible to Skip unused Memory Locations. The Function is only applicable when the **Sequential Memory Access** (reference pages 8 & 13) buttons are pressed.

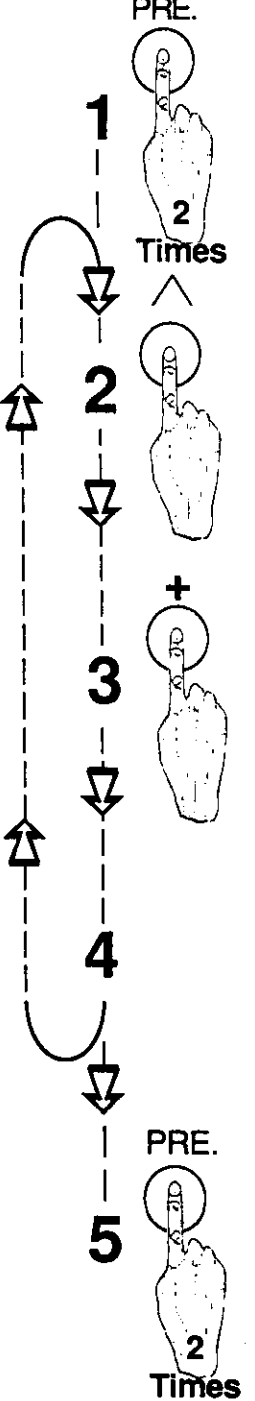
<p>PRE. 1 ↓ 2 ↓ 3 ↓ 4 ↓ 5 ↓ PRE. 2 Times</p> 	<p>Press the "PRE." button 2 Times. The On-Screen information will display "SKIP OFF"</p>
	<p>Select the Memory Location Number to insert the Skip Function into.</p>
	<p>Press Volume "+" button until "SKIP ON" appears upon the screen.</p>
	<p>If more than one Memory location number is to be programmed with the Skip Function, Repeat Steps 2 and 3.</p>
	<p>Press the "PRE." Button 2 times to Finalise the Operation.</p>

To Remove the SKIP function please repeat this process and set to SKIP OFF.

AFC Function (Automatic Frequency Control)

Under normal viewing conditions the AFC remains "ON". However, in areas of poor reception or constant interference, a slight adjustment to the tuning may improve the picture quality. Once the AFC OFF function has been selected fine tuning can be performed.

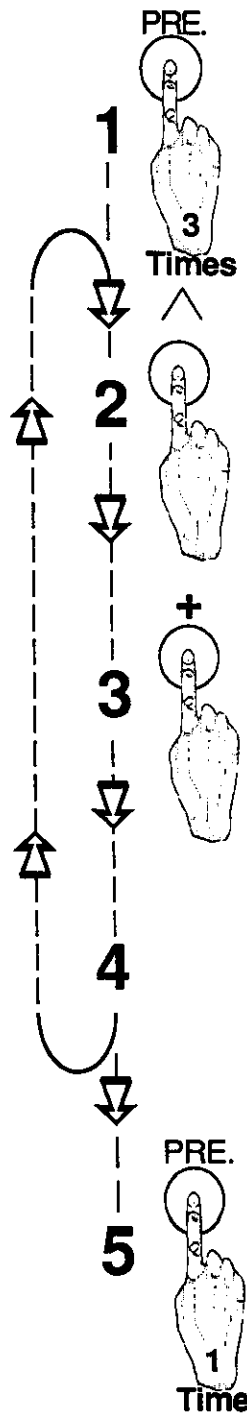

Press the "PRE." button **3** times.

The On-Screen information will display "AFC ON"

Select the Memory location number for which you desire to set the AFC function OFF.

Press Volume "+" button until the word "AFC OFF" appears upon the screen.







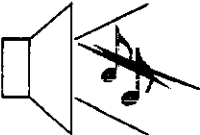

If more than one Memory location number is to be programmed with the AFC OFF function, repeat Steps 2 and 3.

Press the "PRE." button **1** time to finalise the operation. If further tuning is required, refer to page 11.

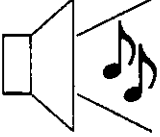
To Reset the AFC function repeat this process and set the AFC ON.

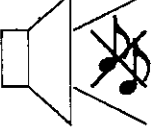
Troubleshooting

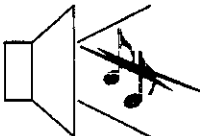
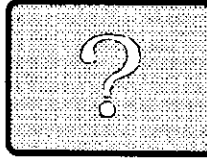
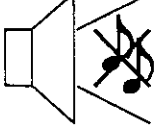
Before calling for Service, determine the symptoms and make a few simple checks as shown below.

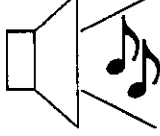
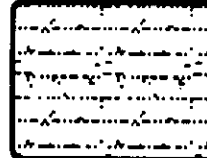
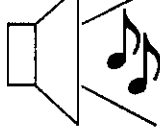
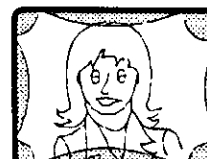
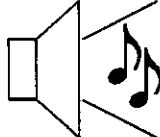
 Snowy Picture	 Noisy Sound	Aerial Location, Direction or Connections
 Multiple Picture	 Normal Sound	Aerial Location, Direction or Connections
 Normal Picture	 No Sound	Volume (Check the Remote Control Mute function)
 Interference	 Noisy Sound	Electrical Appliances, Cars, Motorcycles or Fluorescent Lamps
 No Picture	 No Sound	Not Plugged in at the power outlet, Not switched On at the Television, or Switched to Stand-by, or the Brightness, Contrast and Volume settings.
 No Colour	 Normal Sound	Colour Control.
 Scrambled	 Normal Sound	Retune the Television.
 Coloured Patches	 Normal Sound	Magnetic Interference from unshielded equipment, or the Television moved while "On". (Turn the Television Off at the Main On/Off Switch for Ten minutes).

Specifications

Model TC-59R62

Power Input	:	AC 240V 50 Hz
Power Consumption	:	130W (Max) 12W Stand-By
Antenna Input	:	75Ω Coaxial Type
Receiving Channels	:	VHF Ch. 0 to 11 UHF Ch. 28 to 69 Australian Standard
Picture Tube	:	59cm 90° Deflection
Audio Output	:	4W
Internal Speakers	:	2 - 12x6cm Oval 16Ω
AV Connections	:	Video In 1V p-p, 75Ω Audio In Approx. 400mV~
Dimension	:	Height 51cm Width 61.8cm Depth 46.9cm
Weight	:	29Kg
Remote Control	:	22 Functions

Model TC-25L2Z

Power Input	:	AC 230V 50 Hz
Power Consumption	:	130W (Max) 12W Stand-By
Antenna Input	:	75Ω Coaxial Type
Receiving Channels	:	VHF Ch. 1 to 11 UHF Ch. 21 to 69 New Zealand Standard
Picture Tube	:	59cm 90° Deflection
Audio Output	:	4W
Internal Speakers	:	2 - 12x6cm Oval 16Ω
AV Connections	:	Video In 1V p-p, 75Ω Audio In Approx. 400mV~
Dimension	:	Height 51cm Width 61.8cm Depth 46.9cm
Weight	:	29Kg
Remote Control	:	22 Functions

Specifications are subject to change without notice.

Dimensions and Weight are approximate.

Matsushita Electric Co. (Aust) Pty Ltd
P.O. Box 326 Penrith NSW 2751
ACN: 000 611 389

Printed in Australia TQB4A0071