

PV-500 User's Manual

English

English



~ Contents ~

Overview-----	3~4
Accessories -----	5
Function Modes -----	6
Basic Operation-----	7~13
Turn ON / OFF PV-500-----	7
Select Functions-----	7
SETUP-----	7~9
Adjust Volume-----	9
REC Button-----	10
Basic Operation - Link with Other Equipments-----	11~13
Battery Charging Mode-----	13
Introduction to all the Functions-----	14~17
Video Playback-----	18~21
Video Editing-----	22
Supported Video File Format-----	23
Audio Playback-----	24~25
Audio Editing-----	26
Supported Audio File Format-----	26
Photo Browsing-----	27~28
Slide Show + Audio Playback-----	28~29
Photo Editing-----	29~30
Support Photo File Format-----	30
Record-----	31~34
Audio Line in Rec-----	31~32
Video Line in Rec-----	32~34
Specifications-----	35
Supported File Format-----	36~37
Precautions-----	38

Overview

PV-500 Main device

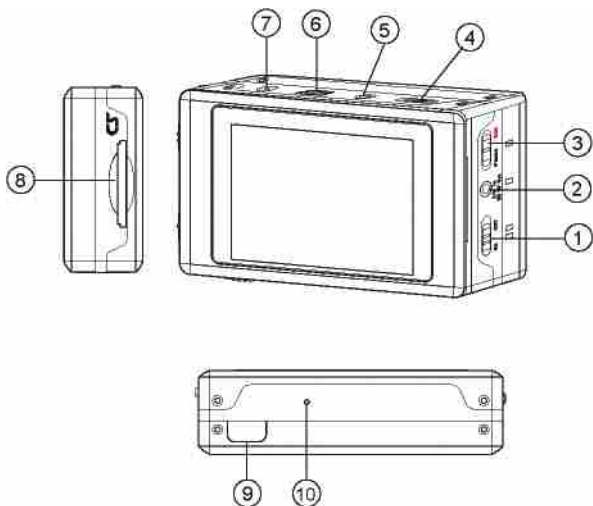

- | | | |
|------------------------|------------------------------------|---------------------------------|
| 1. Power ON/OFF Button | 2. AV Inputs Jack/CCD power supply | 3. Video/Audio Recording Button |
| 4. Exit Button | 5. AV Output Jack | 6. USB Jack |
| 7. Power Supply Jack | 8. SD Card Slot | 9. IR Transceiver |
| 10. Reset Button | | |

Remote Control

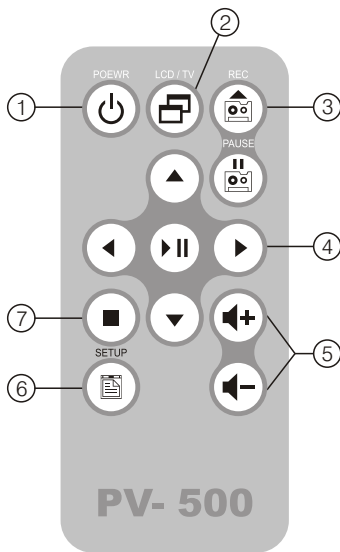

1. Power ON Button

2. LCD/TV Switch
Button

3. Recording Button
and Pause Button

4. Five-direction Key

5. Volume Buttons

6. Setup Button

7. ESC/STOP

Accessories



Stereo Earphones



RAC Cable

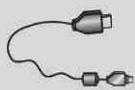

USB Cable



Video Sensor (Optional)



Battery



Remote Control



AC adaptor



User's Manual

Function Modes



Movie



Audio



Photo



Record



Setting

Movie : MP4 video file playback

Audio : audio file Playback

Photo : browse images and pictures

Record : external audio source recording and external
video source recording

Setting : set various functions

Basic operation

Turn on / off the player



Turn On: Stir the Power On/Off button on PV-500 to turn on the power and the greeting screen will appear.

Turn off: Stir the Power On/Off button on PV-500 or press the Power button on the remote control to immediately turn off PV-500.

Select Functions

1. After the player is turned on, it will show the screen of Main Menu, press / / / to select desired functions.
2. After selection, press to enter the function that you've selected.



SETUP

1. While you enter Video, Audio, Image modes, and various standby modes, press SETUP button to edit the settings.



2. Select the item in the main menu: Press  or  to move the cursor.

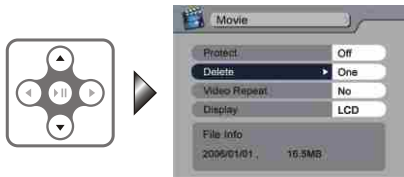

3. Enter the submenu: Press  or  to enter the submenu.

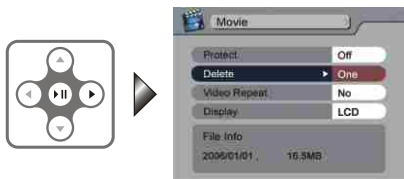

4. Select the item in the submenu: Press  or  to select the desired item.

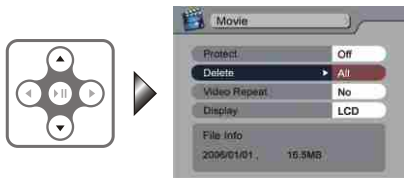

5. Confirm the setting: Press  to confirm the change of the setting.

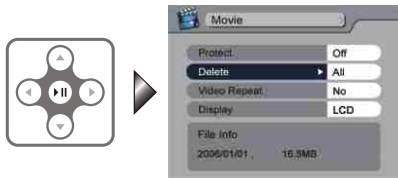

6. Do not make any change and return to main menu: Press or

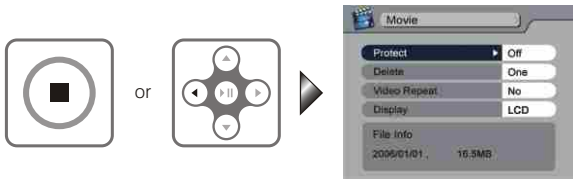

7. Exit SETUP: Press SETUP button or press right after finishing the operation described in 6.



Adjust Volume

While playing Video, Audio or Slide + Audio, you adjust the sound volume by pressing the Volume buttons, volume varies in 10 steps

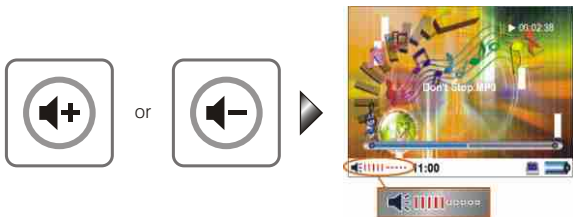

REC Button

1. In the main menu: Pressing the REC button on PV-500 or the REC button on the remote control will lead you to the AV function and start the video recording.



2. Pause the recording: Pressing the REC button on PV-500 or the PAUSE button on the remote control will suspend the video recording operation. If you want to continue recording, please press REC button again.



3. Stop Recording: Press STOP button to stop video recording and the screen returns to Preview Menu.



4. In other Modes: in the modes other than the above-mentioned mode, when you increase the REC button on PV-500 it will "lock" the access and decreasing it can unlock the access. (this function is not available on the remote control)

Basic Operation - Link with Other Equipments

External Video Source Recording

1. By connecting with an external video sensor, it can record the video into video files in MPEG4 format (the file format is AVI).

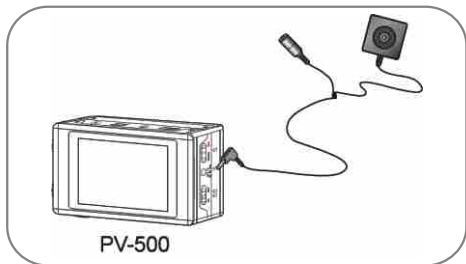

Output to TV Screen

1. Output the image to the TV through an RCA cable

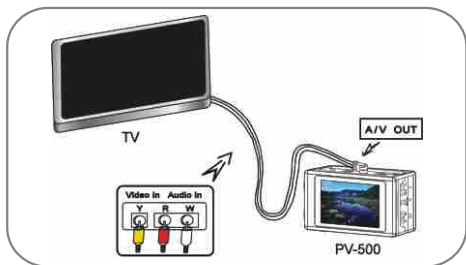

2. Enter the Setup Menu, change the setting of "Display" from "LCD" into "TV".

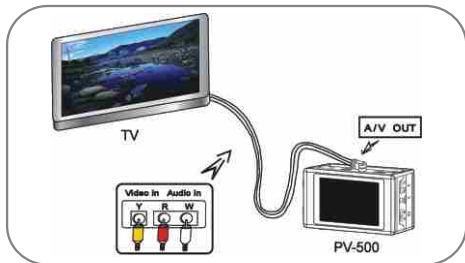

Connect to PC

1. Connect the two ends of the USB cable to PV-500 and PC.

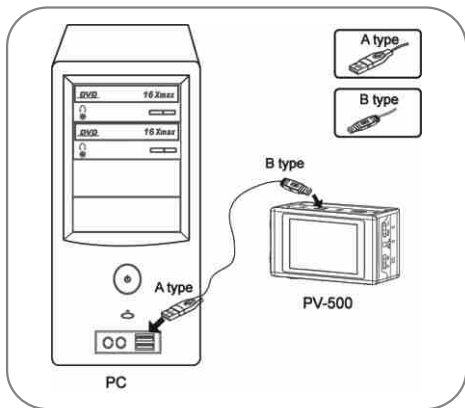

- "USB Mode" will appear on the screen and disappear 5 seconds later, and then it can be operated.



Charging

When the power goes down, power LED indicator blinks (blue) and the meter with no bars displays on the bottom right corner of the screen, which indicates that the power of the host exhausts and please recharge it immediately

Connect the main device with the power supply and then plug the power supply into the electrical outlet. The LED light will always be on (orange light).

Precautions:

The device will turn off the LED light to keep the life-span of the battery, please unplug the power supply promptly after finishing charging the battery.

Introduction to all Setting Functions

- Operate in Main Menu: Press / / / to select the function, then press to enter the Setup Menu



- Enter the Setup Menu



- Video playback repeat mode: allows you to repeat the playback of the selected single/all video files or stop after the playback of all video files.
- Audio playback repeat mode: for audio files in a similar way as that for video files.
- Slide show repeat Mode: make a slide show of all the image files once or repeatedly.
- Slide Show + Audio: make a slide show of the image files and meanwhile playback Audio files automatically (the image and audio files must be put in the same folder)
- Slide Show Time Delay: set the time delay between each image as 3, 5, 7, or 10 seconds.
- Backlight Off Timer: set the time delay to turn off the backlight during playback to 30 seconds, 1 minute, 3 minutes or never turn off.
- TV Format: select the format of the TV to be NTSC or PAL
- Display Selection: it can be switched between LCD and TV
- Language: choose the language of the operating interface

(10) Format: format SD card

(11) Reserved Recording:

Press **OK** or **Left** to select the items for the reserved recording, press **Right** to confirm the setting.



→ External Audio Recording



→ External Video Recording

Time setting: please see "Basic Operation -SETUP" for the procedure of operating the buttons to set the start/end time and the quality for the two kinds of reserved recording modes.



Precautions:

It is needed to set the "Setup" item as "ON" to successfully book the reserved recording.

The reservation will be executed only when the device is in Power On State

The recorded files will be stored in the "MyRecord" folder in the Video/Audio folder

Recording Fail

When there are conflicts in the time setting or when the storage space is not enough: it will show a red forbidden sign to warn that the reserved recording will not be operated, so please set up again.



Interrupt by unknown reasons during recording (low battery, no signal, insufficient space,... etc.): it will show a red forbidden sign to warn that the reserved recording failed.



- (12) Time Setting: please see "Basic Operation - SETUP" for the procedure of operating the buttons.



- (13) Update Firmware: insert the memory card which contains updated software into the device and press Enter button, after the system is updated, it will reboot automatically; if the message "Update Error" is shown, it means that there are errors during updating, it might be that the software is incomplete or the memory card has some problem, please use other memory cards, or reboot the device after inserting the memory card; Toshiba, SanDisk or Panasonic memory cards are



(14) Reset to Default: select to reset default values.



(15) All Space: show the used space

(16) Residual Space: show the residual space

(17) Protection: activate the protection of the files to prevent the file from being deleted

(18) Delete: selectively delete selected file or all files

(19) File Information: show the size and duration of the current file

(20) Quality: set the quality of recording to be the best or standard

Video Playback

Operations in Main Menu

Press **Left** / **Right** / **Up** / **Down** to select the video playback function, then press **Enter** to enter



Operations in File List Mode



Press **Left** or **Right** to choose the file you want to playback, then press **Enter** (if the filename is too long, press **Left** or **Right** to make the adjustment to show the complete filename; press **Up**: return to the upper level menu)





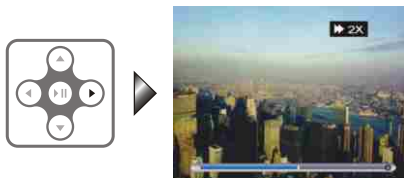

Fast Playback

1. Double Speed Playback: press **Enter** during normal playback, the video file will be played with a speed two times quicker; press **Enter** to return to the normal playback speed.

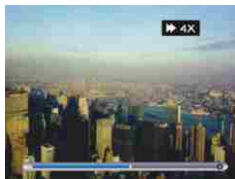

2. 4 Times Speed Playback: press  twice or press  during Double Speed Playback, the video file will be played with a speed four times quicker; press  to return to the normal playback speed.





3. 8 Times Speed Playback: press  three times or press  during 4 Times Speed Playback, the video file will be played with a speed eight times quicker; press  to return to the normal playback speed.



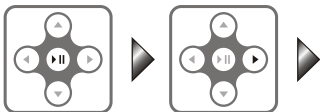

Slow motion function

1. 1/2 Speed Slow Motion: press  after pausing the playback, the video file will be played in 1/2 Slow Motion; press ENTER button to return to the normal playback speed.

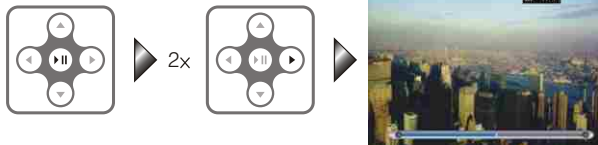

2. 1/4 Speed Slow Motion: press  twice after pausing the playback, the video file will be played in 1/4 Slow Motion; press ENTER button to return to the normal playback speed.



3. 1/8 Speed Slow Motion: press  three times after pausing the playback, the video file will be played in 1/8 Slow Motion; press  button to return to the normal playback speed.

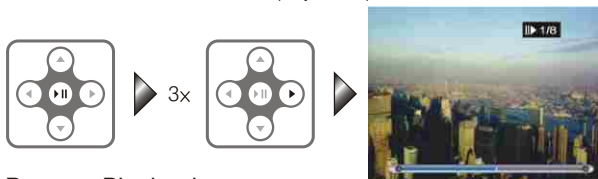

Reverse Playback

The Index bar will go back as the video played reversely; press  to return to normal playback

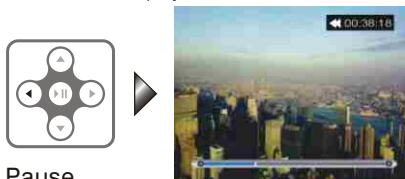

Pause

Pause the Video, Index Bar and the playing time counting; Press  once again to return to normal playback.

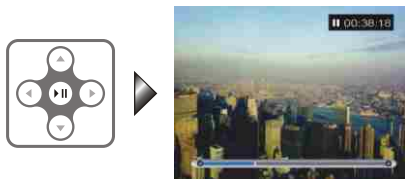

Stop



Press  to stop playing and return to FileList Mode

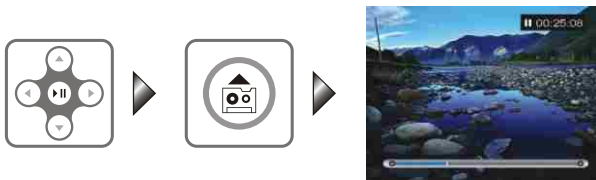

Video Capture

1. **Capture Image while the Video is playing:** Press PAUSE first and then press REC.



2. **Return to normal Playback**
Press  to return to normal playback
3. The number of the captured pictures while the Video is playing is limited within 30, these files will be stored in "MyRecord" folder under photo mode with the filename: V0913001 (V-video, 0913 - MMDD, serial number 001-999); if the number of captured pictures exceeds 30, it will show the message "ABOVERECORDING LIMITED TO 30 FILES" or "ABOVE RECORDING LIMITED TO 999 FILES" if the serial number exceed 999 in one day, press  to exit the message and return to PAUSE state.

Precautions: This function works only after pressing PAUSE during normal playback.

Video Editing

During Video Playback

Press SETUP button, the video will be paused, and the setting items will appear, please see "Basic Operation - SETUP" for the procedure of operating the buttons.



In File List Mode

Press SETUP button, the setting items will appear, please see "Basic Operation - SETUP" for the procedure of operating the buttons.

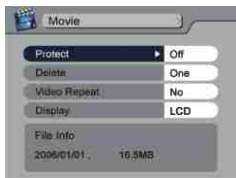

Supported Video File Format

File Format	Resolution	Bit rate	Frame rate
	Under 720*480	Under 4 Mbps	Under 30 fps
AVI(DivX 4/5.0)	●	●	●
AVI(DivX 2/3)	✘	✘	✘
MPEG1(DAT, M PG—VCD file format)	✘	✘	✘
ASF	✘	✘	✘
RM	✘	✘	✘
WMV	✘	✘	✘
VOB (DVD file format without copy protection)	✘	✘	✘
MJPEG(AVI)	a-law, u-law		

Notice: ● can be played in PV-500 directly

✘ can not be played directly, and is not able to be converted

Audio Playback

Operations in Main Menu

Press **Left** / **Right** / **Enter** to select the file you want to play, after the file is selected, press **Enter** to enter Audio Playback function.



Operations in File List Mode

Press **Up** or **Down** to select the file you want to play, after the file is selected, press **Enter** (if the filename is too long, press **Left** or **Right** to make the adjustment to show the complete filename; press **Enter**: return to the upper level menu).



Fast Playback

During Fast Playback, the Index bar and the playing time counting will become faster along with the file playback; press **Enter** to return to the normal playback.

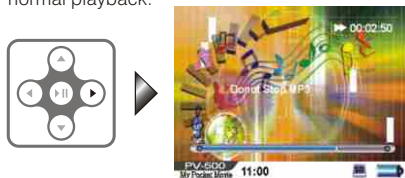

Reverse Playback

During Reverse Playback, the Index bar and the playing time counting will become reversed along with the reverse playback; press  to return to the normal playback.



Pause

By pressing PAUSE button, the Audio, the Index bar and the playing time counting will be paused; press  once again to return to normal playback.

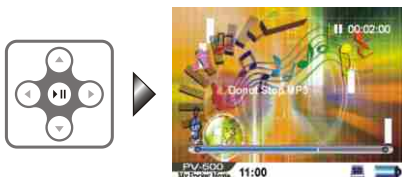

Stop

Press  to stop the playback immediately and return to File List Mode.



Audio File Editing

During Audio Playback

Press SETUP button, the audio playback goes on, the setting items appears, please see "Basic Operation - SETUP" for the procedure of operating the buttons.



In File List Mode

Press SETUP button, and the setting items will appear; please see "Basic Operation - SETUP" for the procedure of operating the buttons.



Supported the form in audio frequency

File Format	
MPEG1 layer-3 version 1/2/2.5 stereo	●
MPEG1 layer-3 version 1/2/2.5 Joint-stereo	●
WMA(64 kbps~320 kbps)	●
WAV	●

Photo Browsing

Operations in Main Menu

Press **Left** / **Right** / **Down** to select Image Browsing Mode and press **Enter** to enter.



Operations in File List Mode

Press **Left** or **Right** to select the file you want to play, after the file is selected, press **Enter** (if the filename is too long, press **Left** or **Right** to make the adjustment to show the complete filename; press **Left**: return to the upper level menu).





Select the Photo for Browsing

Press **Left** or **Right** to select to browse the previous or next image.



Zoom in the Photo by 2 times / 4 times

1. Zoom in by 2 times: press  (while the image is enlarged, press  /  to move the position)



2. Zoom in by 2 times: press  two times



Notice:

The screen will show the current magnification -- 2X/4X; if the image is displayed in full screen state and 4X is shown, and at this moment if you press  without see any effect, it means that the image has been magnified to its maximum extent and it is impossible to enlarge any more.

Slide Show + Audio

file listIn File List Mode or Image Browsing Mode, press SETUP button to show the setting items, select "StartSlide Show" and press  to start the Slide Show + Audio function (the image files and the Audio files that you want to play need to be stored in the same folder.)

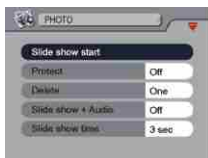

(In File List Mode)



(During Image Browsing)

Pause

1. Pause Slide Show

Press **PAUSE** or **STOP** to pause Slide Show

2. Cancel Pause

While Slide Show is paused, press **PAUSE** again.

Stop the slide to broadcast

Press **STOP** once, after pressing **PAUSE** button

Photo Editing Mode

During Photo Browsing

Press **SETUP** button, the setting items appear please see "Basic Operation - SETUP" for the procedure of operating the buttons.



In File List Mode

Press SETUP button, the setting items appear, please see "Basic Operation - SETUP" for the procedure of operating the buttons.



Supported Photo File Format

Encoding File Format	Baseline	Progressive
JPG	Lower than 4096x4096	Lower than 1024x1024

Record

Audio Line in REC

1. Select Record Function

Press / / / in Main Menu to select Record function, then press to enter.



2. Select Audio Line in REC

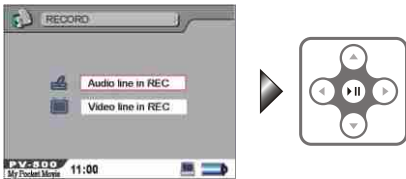

3. Start Record

Press REC button to start recording, the file will be stored in "MyRecord" folder.

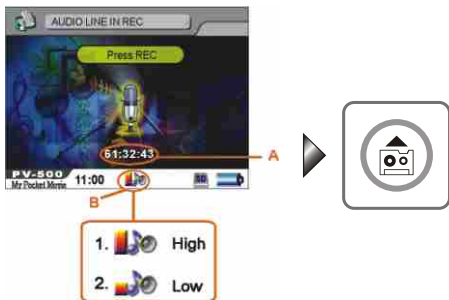

4. Pause

(1) Pause Recording

Press the PAUSE button on the remote control or decrease the REC key on PV-500 to pause the recording and return to the standby mode.

(2) Cancel Pause

Press the REC button on the remote control or increase the REC key on PV-500 to continue the recording and store it in the same file.

5. Stop

During the recording, press  or REC button to stop the recording immediately and return to the standby mode.

6. The recorded Video file will be stored in the "MyRecord" folder in MOVIE and the recorded sound file will be stored in the "MyRecord" folder in MUSIC.

Video Line in REC

1. In Main Menu: increase the REC button on PV-500 or press the REC button on the remote control to enter the AV function, and the recording starts.



2. Select Recording Function: In Main Menu: press  /  /  to select the recording function, and press  to enter.



3. Select Video Line in REC

Select External Video Source Recording, press ENTER button to enter standby mode (make sure to connect the video sensor to the AV IN jack on PV-500, it will record the video into a MPEG4 file whose format is AVI)

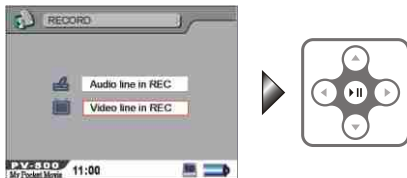

4. If the message "Press REC button" disappears: in Standby mode, if there is no operation within 5 seconds, the messages of recordable time, quality and "Press REC button" will disappear, you have to press REC button again to return to Standby Mode, and then press REC button in Standby Mode to start the recording.



5. Start Recording

Press REC button to start recording, the file is stored in "MyRecord" folder.



6. Pause

(1) Pause Recording

Press the PAUSE button on the remote control or decrease the REC key on PV-500 to pause the recording and return to the standby mode.

(2) Cancel Pause

Press the REC button on the remote control or increase the REC key on PV-500 to continue the recording and store it in the same file.

7. Stop Recording

During the recording, press  or REC button to stop the recording immediately and return to Standby Mode.

8. The recorded Video file will be stored in the "MyRecord" folder in MOVIE and the recorded sound file will be stored in the "MyRecord" folder in MUSIC.

Specifications

Timer	Time
Display	Resolution 160 x R.G.B x 240 2.37 inch TFT-LCD with LED backlight NTSC/PAL composite output
AV IN/OUT	AV input/output through two φ 2.5mm jacks
LED Indication Light	LED1 - Charging (orange) LED2 - Power (blue) LED3 - Signal Source Detection (green) LED4 - Audio/Video recording, file operation (red)
Storage Device	SD card
Computer Connection	USB 2.0 mini connector
Power System	Rechargeable/Exchangeable Lithium Ion Battery 3.6V 1250mAh. Power supply 100~240 V, 50~60 Hz
Dimension / Weight	x x mm g / g, with/out the battery respectively.
System Requirements	Operating system: Window2000, Window XP CPU: Intel Pentium III 800MHz and beyond Relevant hardware accessories: USB port, Mouse, CD-ROM, Windows-compatible display with a required resolution of 1024 x 768

Supported Video File Format

Supported Video File Format

File Format	Resolution	Bit rate	Frame rate
	Under 720*480	Under 4 Mbps	Under 30 fps
AVI(DivX 4/5.0)	●	●	●
AVI(DivX 2/3)	✘	✘	✘
MPEG1(DAT, M PG—VCD file format)	✘	✘	✘
ASF	✘	✘	✘
RM	✘	✘	✘
WMV	✘	✘	✘
VOB (DVD file format without copy protection)	✘	✘	✘
MJPEG(AVI)	a-law, u-law		

Notice: ● can be played in PV-500 directly

✘ can not be played directly, and is not able to be converted

Supported the form in audio frequency

File Format	
MPEG1 layer-3 version 1/2/2.5 stereo	●
MPEG1 layer-3 version 1/2/2.5 Joint-stereo	●
WMA(64 kbps~320 kbps)	●
WAV	●

Supported Image File Format

Encoding File Format	Baseline	Progressive
JPG	Lower than 4096x4096	Lower than 1024x1024

Precautions

Before using this product, please read this manual in detail to ensure you are using this product properly.

During the recording in various REC Modes, all button-pressing is disabled.

All the recorded files are stored in the "MyRecord" folder.

After the setting of Reserved Recording and Alarm functions, the setting will be executed only when the "SET" item is selected as "ON" afterwards.

Reserved Recording and Alarm functions will be executed after the device is turned off.

If the file is corrupted so that it cannot be played, the part of the file that is corrupted will be skipped. If the file is still unable to be played, it will jump to the next file.

Only the files with the extension of MP3, WMA, WAV, ASF, AVI, BMP and JPG can be played.

The player can distinguish an unlimited number of files/folders. However, within a folder, only up to 999 files can be distinguished.

The maximum playing time of video files is limited to 2 hours and the maximum playing time of audio files is limited to 3 hours.

In the Video files, only the audio in MP3 and WMA format is supported, AC3, DTS, AAC and other formats are not supported.

All data in the device may be deleted due to excessive impact, lightning, power surge etc., the manufacturer does not bear or guarantee the losses caused in the above conditions, please protect and back up the data in the device properly.

Please avoid serious vibration; physical vibration might damage the LCD.

Please do not apply heavy pressure on the player; the player may be damaged because of heavy pressure.

When the memory card is taken out from your PV-500, the card may feel warm due to long-time operation, it is a normal phenomenon.

If the memory card is inserted in the wrong direction, the card can not be pushed completely into the bottom of the slot, please do not push hard to avoid damaging the card and the device.

While connecting the device to a PC through USB, you can read directly from the SD card and run the files in the storage device.

If you connect the device to a PC through USB, and use the computer to format the storage device, please use FAT32 format.

Please do not scrub the LCD with hard materials, because the LCD is easy to be damaged. If you want to remove the dust on the LCD screen, please clean the body with a soft dry cloth, if dirt or stains are left, you can clean it with a little soft cleansing liquid; do not use volatile solutions because they will cause chemical reactions, thus the device might be deformed or discolored.

If the device is moved from a cold place to a warm one, the LCD screen will fog up; if this situation takes place, please turn off your PV-500 and wait for about one hour before use.

Please do not store or use your device in the following places:

1. Extremely humid or dusty places.
2. Places with direct sunlight or a high temperature, e.g.: it will damage your PV-500 in a closed car in the summer or a very cold place.
3. Places with heavy vibration or strong magnetic fields, e.g.: close to automobiles, voltage transformers or magnets.