

# Palsonic

## LCD TV

### TFTV-430 USER'S MANUAL

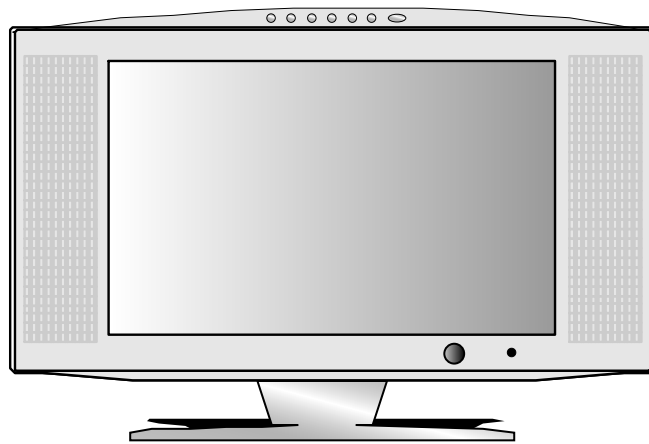

PALSONIC CORPORATION PTY LTD  
1 JOYNTON AVENUE  
WATERLOO NSW 2017 AUSTRALIA  
TEL: (02) 9313 7111  
FAX: (02) 9313 7555  
[www.palsonic.com.au](http://www.palsonic.com.au)

**PALSONIC CUSTOMER SERVICE  
TELEPHONE  
AUSTRALIA: 1300 657 888**

# Contents

◆ Safety Precautions .....	1
◆ Important Safety Instructions .....	2
◆ Overview of TV	
i. Panel Description .....	4
ii. Back Panel Description .....	5
◆ Antenna Connections .....	6
◆ Connections	
i. AV Connections .....	7
ii. DVD Player Connection .....	8
iii. PC Connections .....	9
◆ Remote Control Overview (All Functions Except Teletext) .....	10
◆ Remote Control Overview (Teletext Functions) .....	11
◆ Remote Control Operation .....	12
◆ Basic Operation .....	13
◆ Menu Operation	
i. Picture Menu .....	15
ii. TV Menu .....	16
iii. Option Menu .....	21
iv. PC Menu .....	27
◆ Functional Button Instruction .....	28
◆ Teletext .....	32
◆ Play Flash Memory Card .....	34
◆ Stand Uninstallation .....	37
◆ Maintenance .....	38
◆ Trouble Shooting .....	39
◆ Specifications .....	40

# Safety Precautions

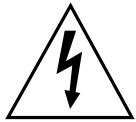

THE LIGHTNING FLASH WITH ARROW-HEAD SYMBOL WITHIN AN EQUILATERAL TRIANGLE IS INTENT TO ALERT THE USER TO THE PRESENCE OF UNINSULATED "DANGEROUS VOLTAGE" WITHIN THE UNIT'S CABINET THAT MAY BE OF SUFFICIENT MAGNITUDE TO CONSTITUTE A RISK OF ELECTRIC SHOCK TO PERSONS.



THE EXCLAMATION POINT WITHIN AN EQUILATERAL TRIANGLE IS INTENDED TO ALERT THE USER TO THE PRESENCE OF IMPORTANT OPERATING AND MAINTENANCE (SERVICING) INSTRUCTIONS IN THE MANUAL ACCOMPANYING THE UNIT.

## WARNING:

TO PREVENT FIRE OR ELECTRIC SHOCK, DO NOT EXPOSE THE UNIT TO RAIN OR MOISTURE. NEVER ATTEMPT TO OPEN THE CABINET, DANGEROUS HIGH VOLTAGES ARE PRESENT IN THE UNIT. REFER SERVICING TO QUALIFIED SERVICE PERSONNEL.

## NOTE TO CABLE/TV INSTALLER:





This reminder is provided to call the cable TV system installer's attention to Article 820-40 of the National Electric Code (U.S.A.). The code provides guidelines for proper grounding and, in particular, specifies that the cable ground shall be connected to the grounding system of the building, as close to the point of the cable entry as practical.

### Wet Location Marking C-UL

Apparatus shall not be exposed to dripping or splashing and no objects filled with liquids, such as vases, shall be placed on the apparatus.

## NOTE TO CABLE/TV INSTALLER:

This equipment has been tested and found to comply with the limits for a Class B digital device, pursuant to Part 15 of the FCC Rules. These limits are designed to provide reasonable protection against harmful interference when the equipment is operated in a residential installation. This equipment generates, uses and can radiate radio frequency energy and, if not installed and used in accordance with the instruction manual, may cause harmful interference to radio communications. However, there is no guarantee that interference will not occur in a particular installation. If this equipment does cause harmful interference to radio or television reception, which can be determined by turning the equipment off and on, the user is encouraged to try to correct the interference by one or more of the following measures:

-  Reorient or relocate the receiving antenna.
-  Increase the separation between the equipment and receiver.
-  Connect the equipment into an outlet on a circuit different from that to which the receiver is connected.
-  Consult the dealer or an experienced radio/TV technician for help.
-  When in use, there must be a distance at least 5cm between the TV and some object front or back of it, at least 1 cm between the TV and some object leftward or rightward of it .

## CAUTION:

Do not attempt to modify this product in any way without written authorisation from PALSONIC Corporation Pty Ltd. Unauthorised modification could void the user's authority to operate this product.

**RECORD YOUR MODEL NUMBER**  
(Do this now, while it is convenient)

The model and serial number of your Machine are located on the back of the TV cabinet. For your future convenience, we suggest that you record these numbers here:

MODEL  
NO.....  
SERIAL  
NO.....

# Important Safety Instructions

---

1. Read These Instructions - All the safety and operating instructions should be read before the product is operated.

2. Keep These Instructions - The safety and operating instructions should be retained for future reference.

3. Heed All Warnings - All warnings on the product and the operating instructions should be adhered to.

4. Follow All Instructions - All operating and use instructions should be followed.

5. Do not use this product near water - Do not use this product near water for example, near a bathtub, wash bowl, kitchen sink, or laundry tub; in a wet basement; or near a swimming pool; and the like.

6. Clean only with dry cloth - Unplug this product from the wall outlet before cleaning. Do not use liquid cleaners or aerosol cleaners. Use dry cloth for cleaning.

7. Do not block any ventilation openings. Install in accordance with the manufacturer instructions.

8. Do not install near any heat sources such as radiators, heat register, stoves, or other apparatus (including amplifiers) that produce heat.

9. Do not defeat the safety purpose of the polarised grounding-type plug. A polarised plug has two blades with one wider than the other. A grounding type plug has two blades and third grounding prong. The wide blade or the third prong are provided for your safety. If the provided plug does not fit into your outlet consult an electrician for replacement of the obsolete outlet.

10. Protect the power cord from being walked on or pinched particularly at plugs, convenience receptacles, and the point where they exit from the apparatus.

11. Only use attachments and accessories specified by the manufacturer.

12. Use only with the cart, stand, tripod, bracket, or table specified by the manufacturer, or sold with the apparatus. When a cart is used, use caution when moving the cart. Apparatus combination to avoid injury from tip-over.



PORTABLE CART WARNING  
(Symbol provided by RETAC)

13. Unplug this apparatus during lightning storms or unused for long period of time.

14. Refer all servicing to qualified service personnel. Servicing is required when the apparatus has been damaged in any way, such as power-supply cord or plug is damaged, liquid has been spilled or objects have fallen into the apparatus, the apparatus has been exposed to rain or moisture, does not operate normally, or has been dropped.

15. This product should be operated only from the type of power source indicated on the marking label. If you are not sure of the type of power supply to your home, consult your product dealer or local power company. For products intended to operate from battery power, or other sources, refer to the operating instructions.

16. Protective Attachment Plug -The product is equipped with an attachment plug having overload protection. This is a safety feature. See Instruction Manual for replacement or resetting of protective device. If replacement of the plug is required, be sure the service technician has used a replacement plug specified by the manufacturer that has the same overload protection as the original plug.

# Important Safety Instructions

17. Power Lines - An outside antenna system should not be located in the vicinity of overhead power lines or other electric light or power circuits, or where it can fall into such power lines or circuits. When installing an outside antenna system, extreme care should be taken to keep from touching such power lines or circuits as contact with them might be fatal.

18. Overloading - Do not overload wall outlets, extension cords, or integral convenience receptacles as this can result in a risk of fire or electric shock.

19. Object and Liquid Entry - Never push objects of any kind into this product through openings as they may touch dangerous voltage points or short-out parts that could result in a fire or electric shock. Never spill liquid of any kind on the product.

20. Replacement Parts - When replacement parts are required, be sure the service technician has used replacement parts specified by the manufacturer or have the same characteristics as the original part. Unauthorized substitutions may result in fire, electric shock, or other hazards.

21. Safety Check - Upon completion of any service or repairs to this product, ask the service technician to perform safety checks to determine that the product is in proper operating condition.

22. Wall or Ceiling Mounting -The product should be mounted to a wall or ceiling only as recommended by the manufacturer. Any mounting of the product should follow the manufacturer instructions, and should use a mounting accessory recommended by the manufacturer.

23. Outdoor Antenna Grounding - If an outside antenna or cable system is connected to the product, be sure the antenna or cable system is grounded so as to provide some protection against voltage surges and built-up static charges. Article 810 of the National Electrical Code, ANSI/NFPA 70, provides information with regard to proper grounding of the mast and supporting structure, grounding of the lead-in wire to an antenna discharge unit, size of grounding conductors, location of antenna discharge unit, connection to grounding electrodes, and requirements for the grounding electrode. See figure below.

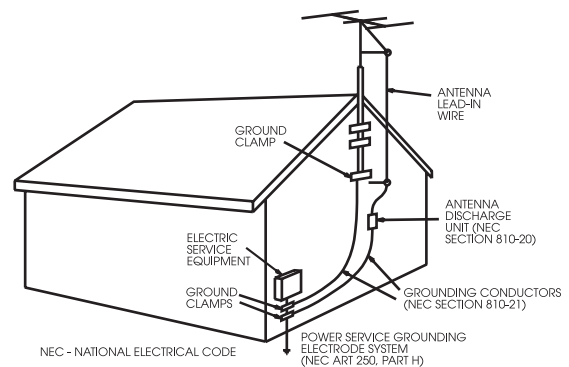

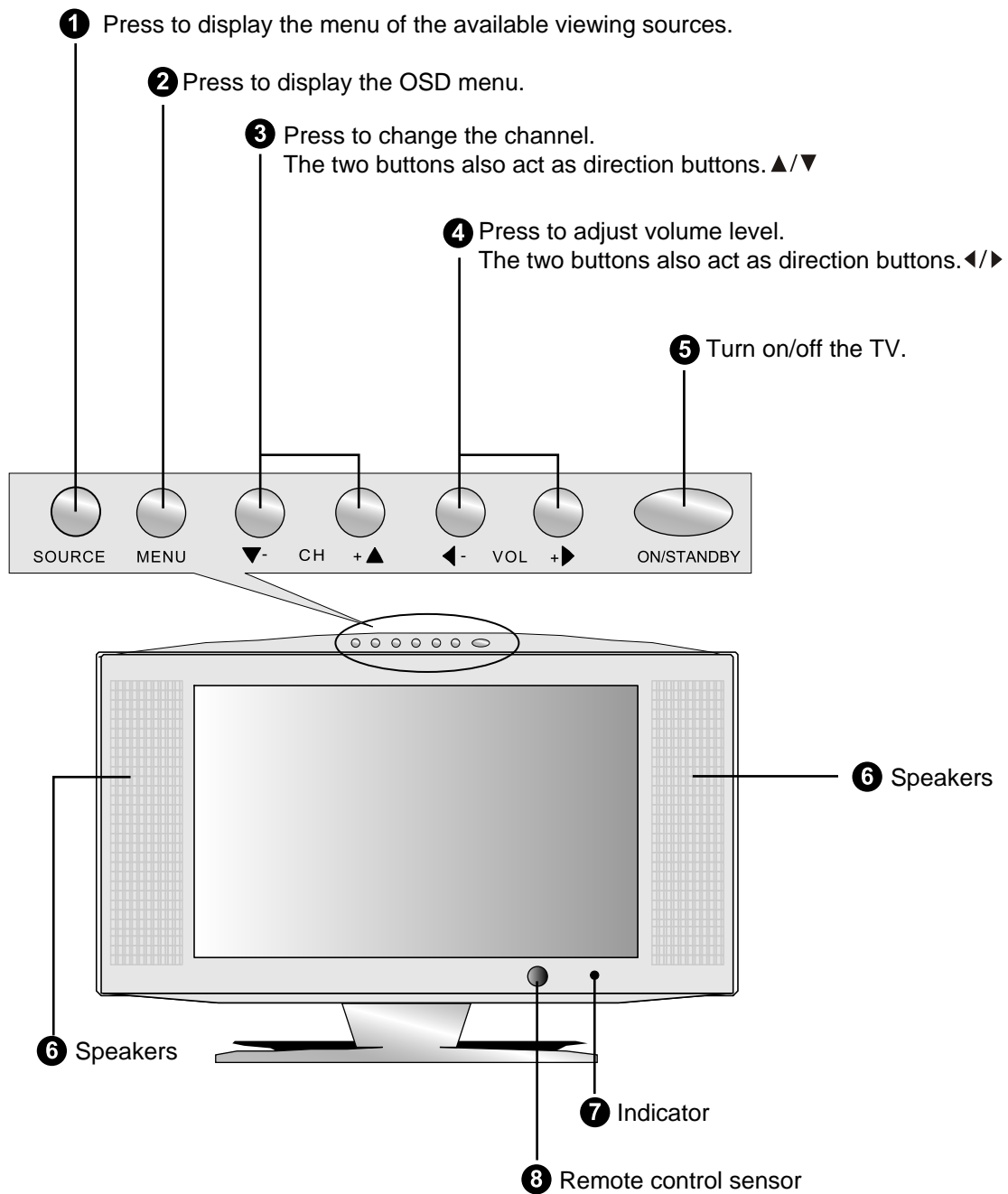

# Back Panel Description

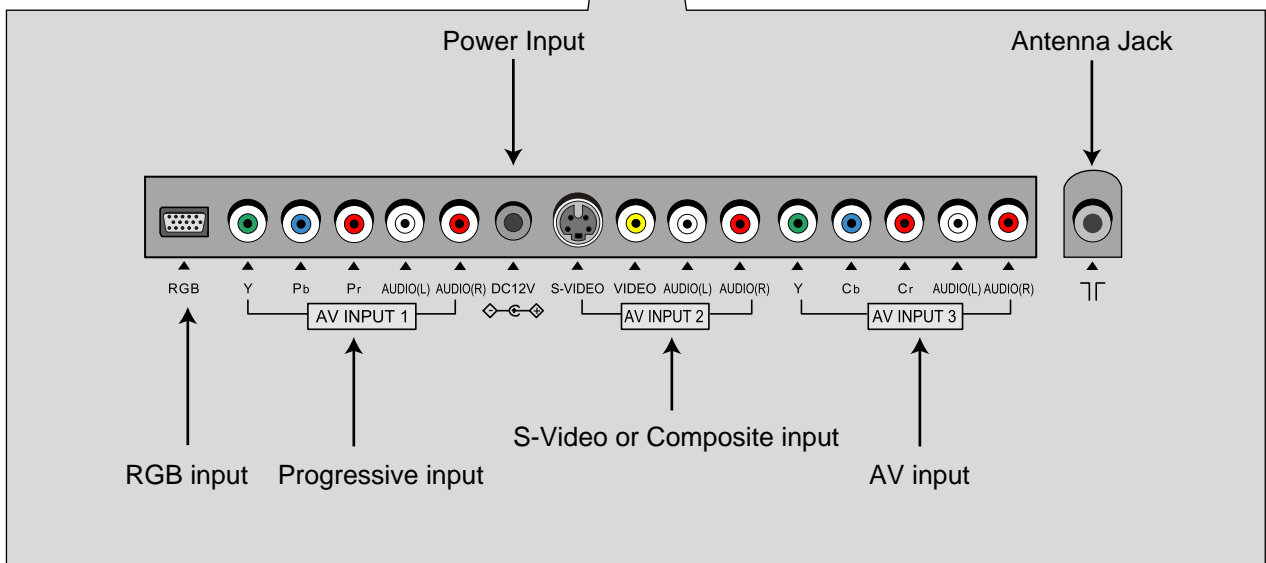
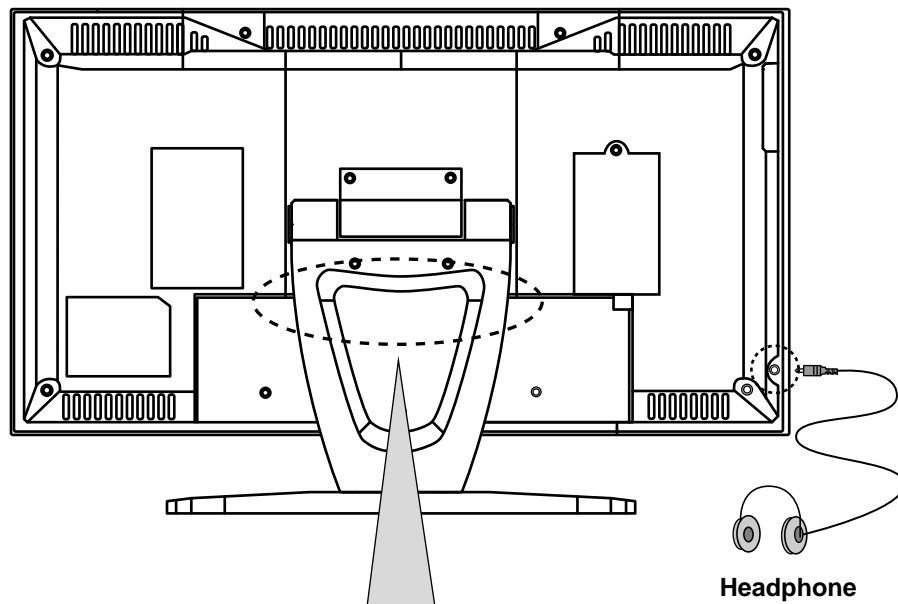

# Antenna Connections

\* For optimum picture quality, adjust antenna direction.

## Indoor Antenna Connections

Typical Wall antenna jack used in apartment buildings, connect the antenna cable as shown below (Please use the correct type of antenna cable according to the type of wall antenna jack).

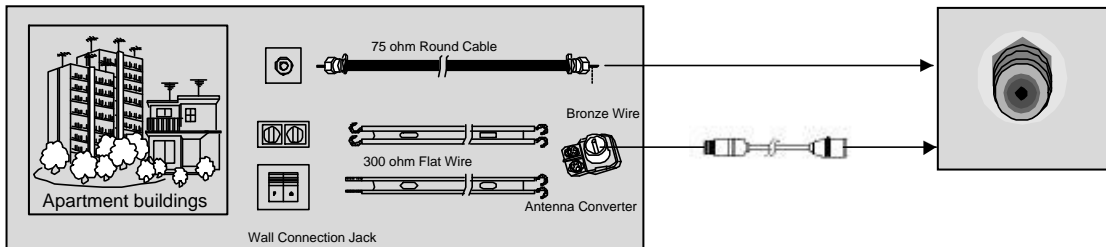

- \*If you have a 75 ohm round cable, insert the bronze wire and then tighten the connection nut.
- \*If you have a 300 ohm flat wire, connect the twisted wire to the antenna converter and then connect the converter to the antenna jack on the TV.
- \* When using 75 ohm round cable, please do not bend the bronze wire, it may make the video quality poor.

## Outdoor Antenna Connections

This type of antenna is commonly used in single family dwellings.

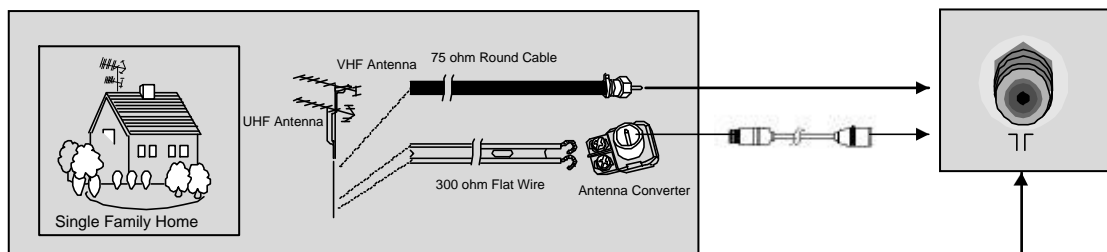

- \* In poor signal areas, to get better picture quality, install the antenna as shown to the right.
- \* You can share the antenna with a signal splitter for two TV sets.

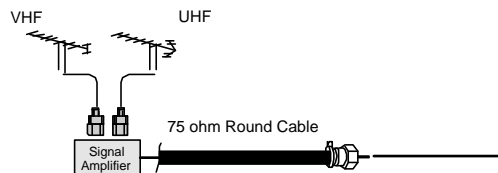



# AV Connections

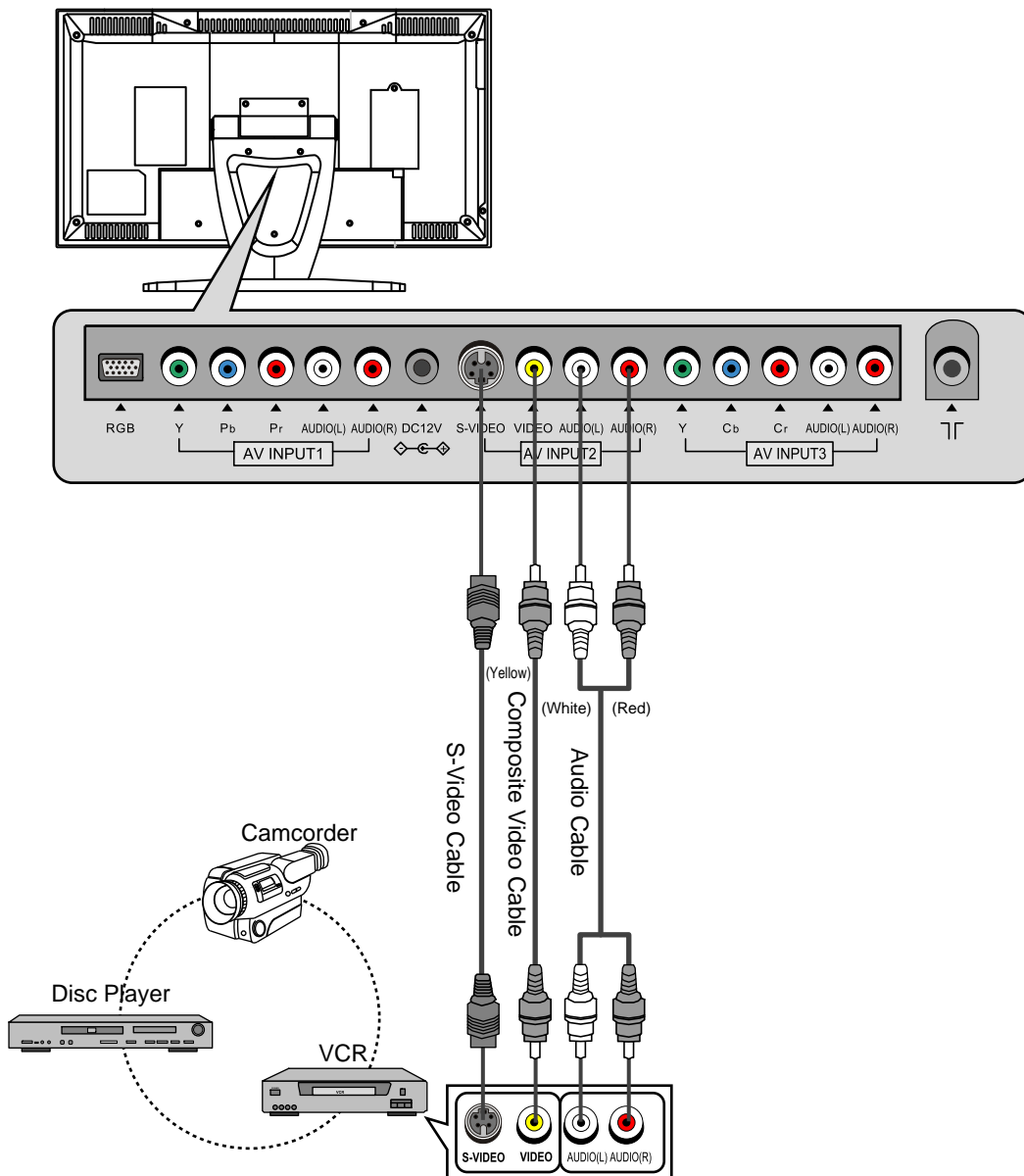

## Notes:

You can connect the TV set with Disc player, Camcorder and VCR following the methods below :

1: S-Video Cable + Audio Cable.

Please choose "S-Video" when you select the viewing source.

2: Video Cable + Audio Cable.

Please choose "AV" when you select the viewing source.

# DVD Player Connection

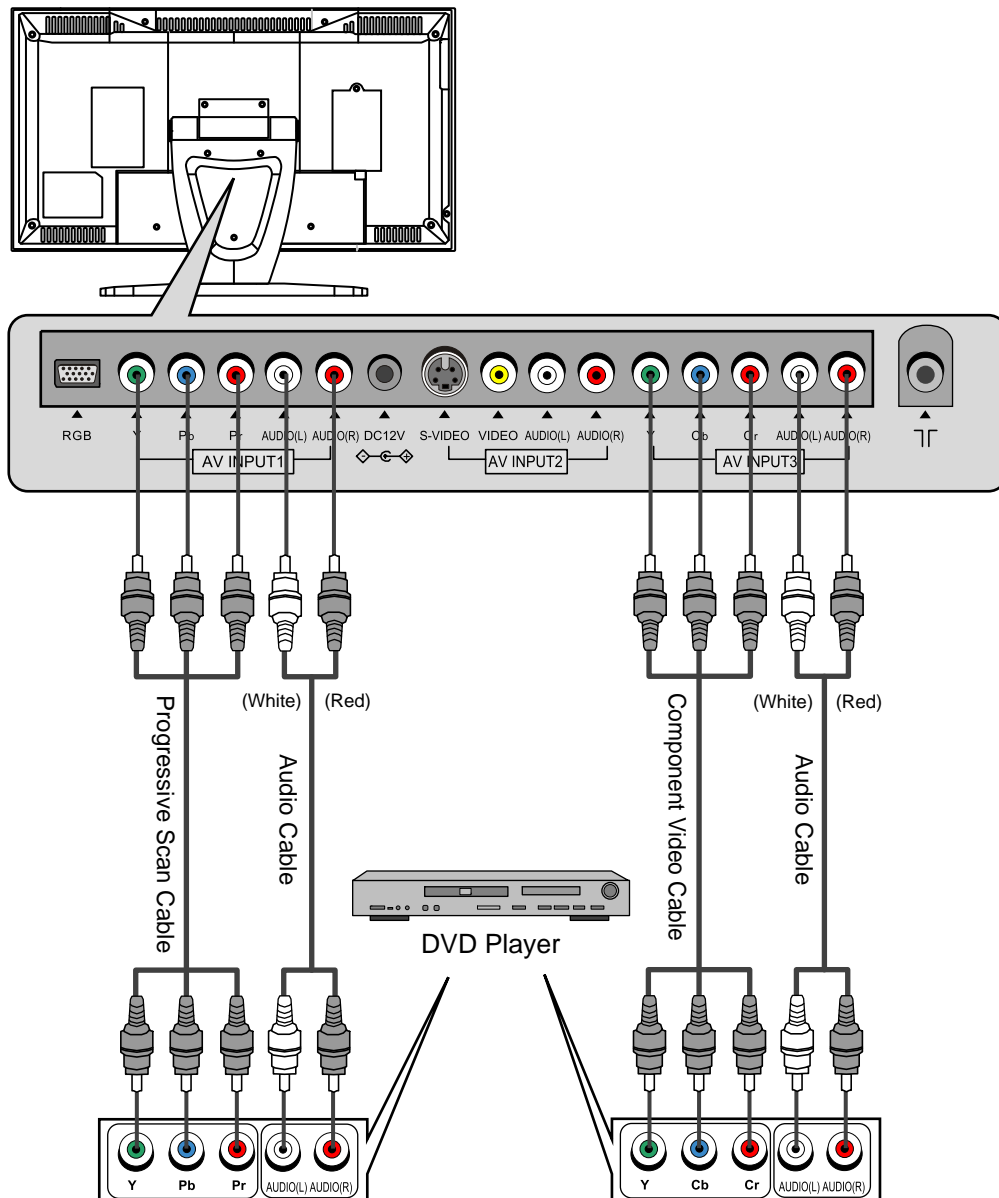

## Notes:

Please refer to the methods below to connect TV with DVD Component signal:

1. Connect YCbCr Cable and Audio Cable to corresponding Jacks of DVD  
Please choose the "YCbCr" when you select viewing source.
2. Connect Progress Scan Cable and Audio Cable to the corresponding jacks of DVD.  
Please choose "YPbPr" when you select viewing source.

# PC Connections

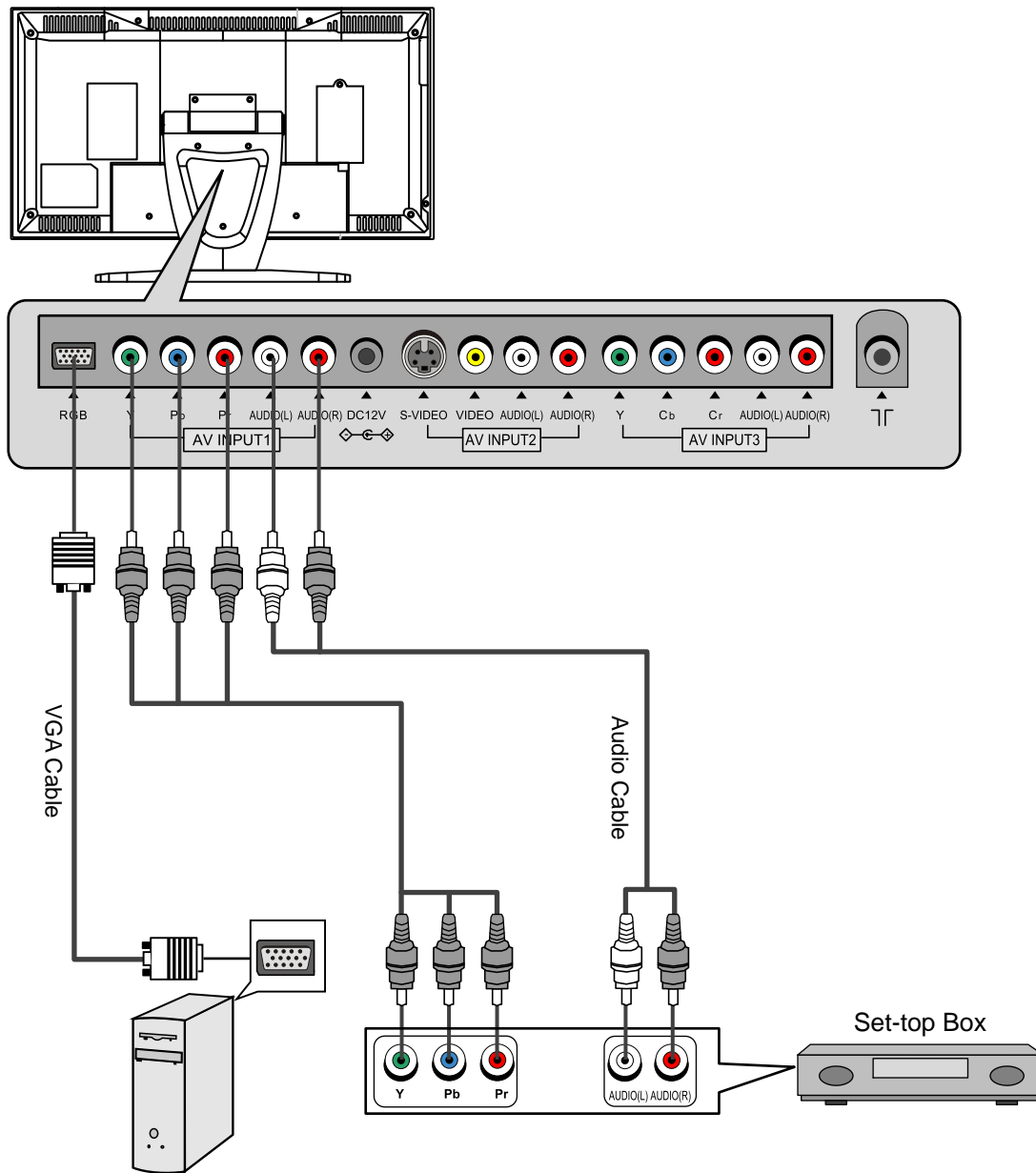

## Notes:

Please refer to the upward method to connect TV with set-top Box or PC.

1. Connect VGA Cable and Audio Cable to the corresponding jack of PC or Set-top Box. Please choose "PC" or "YPbPr" when you select viewing source.

# Remote Control Overview (All Functions Except Teletext)

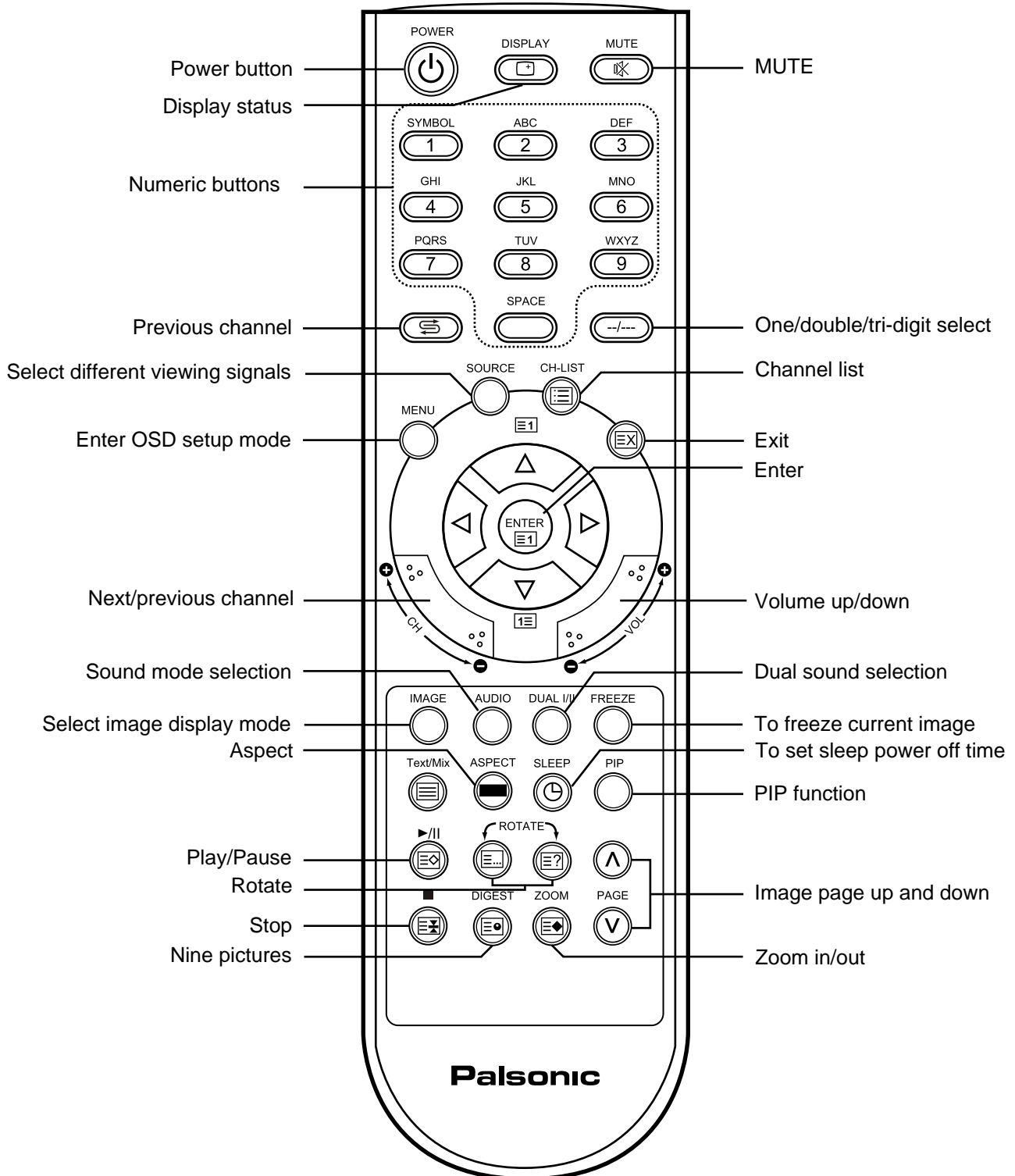

# Remote Control Overview (Teletext Functions)

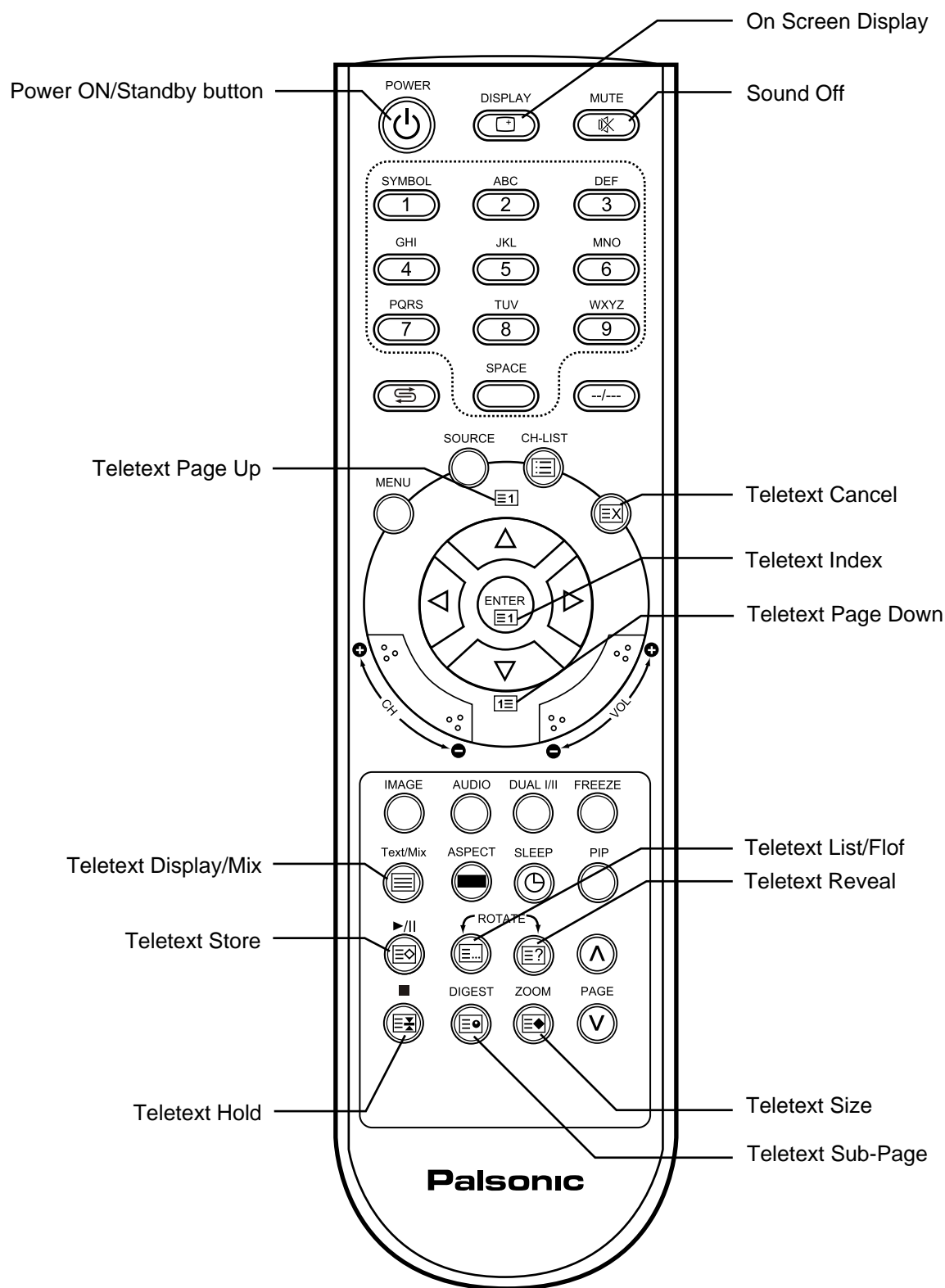

# Remote Control Operation

## Batteries installation

Pull the battery cover upward in the direction shown by the arrow and remove it.

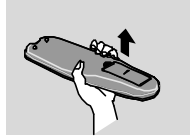

Insert the batteries with correct polarity.

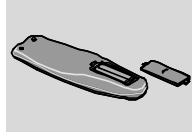

Replace the battery compartment cover.

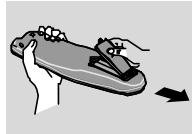

## Remote control direction

Point the remote control at the remote sensor.

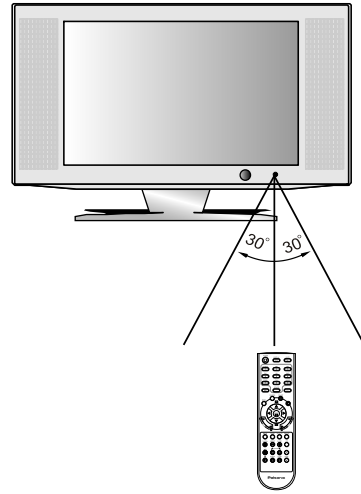

Make sure there are no objects between the remote control and its sensor.



Don't place the remote control near a heater or in a damp place. A strong impact on remote control may damage it.

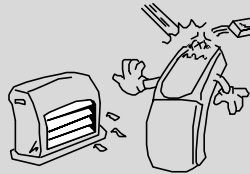

Signal from the remote control may be disturbed by sun light or other strong light. In this case, darken the room.

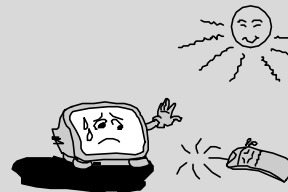

## Adjusting the vertical TV Viewing Angle

### Rotatable Stand

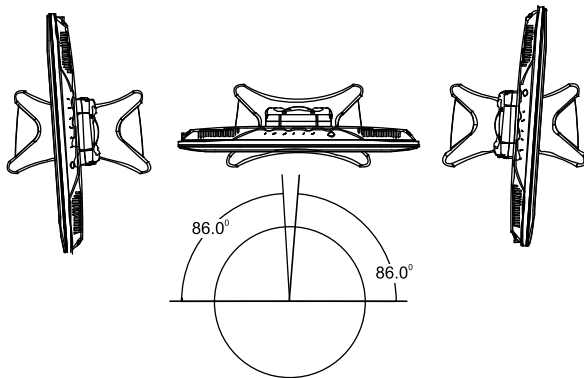

### Rotatable Panel

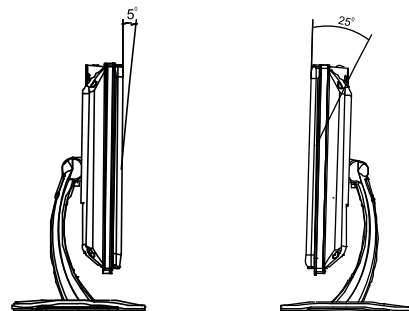

# Basic Operation

## Turn On/Off

1. Connect the antenna cable to the antenna input port on TV.
2. Connect the adapter to the power input port on TV.
3. Put the power line plug into the jack of adapter.
4. Plug the power cord into the wall power outlet after connecting the power cord to the adapter. Then the TV will be in standby mode.

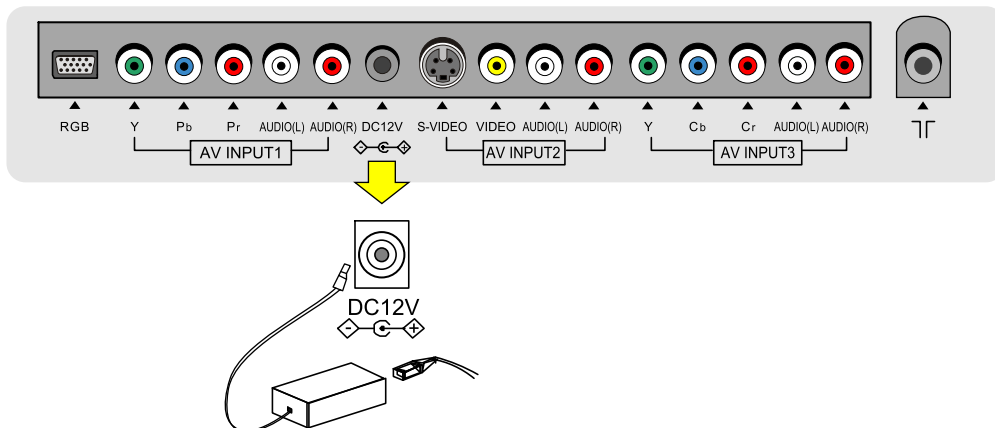

5. Press "POWER" button on the remote control to turn on the TV.
6. Select viewing source:

Press the "SOURCE" button to display "Select source" menu as follows:

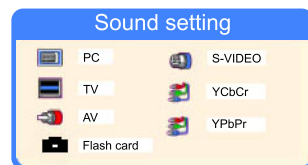

Use the direction buttons to select desired signal, and press "ENTER" button to confirm.

7. After viewing, press the "POWER" button on the remote control. The TV reverts to stand-by mode.
8. In standby mode, the power consumption is less the 3 watts per hour. If you do not use the TV set usually, please disconnect the AC adapter and the jack after viewing.

# Basic Operation

## Menu Description

If you want to adjust the display settings, please follow the instruction below.

Press the "MENU" button to browse the PICTURE MENU, TV MENU, OPTION MENU, PC MENU in turn. Press "EXIT" to quit menu mode.

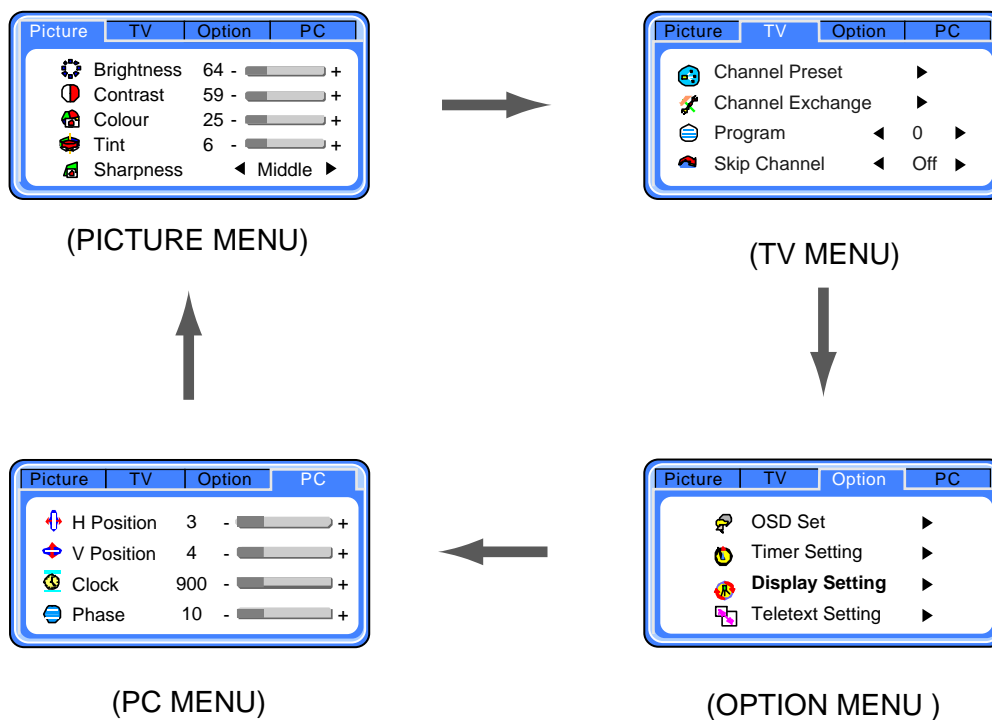



## Display Performance Adjust

You can adjust brightness, contrast and colour to meet your favourite picture requirement.

- Press the "MENU" button to select " Picture" mode.
- Press " ▲/▼ " buttons to select the item you want to adjust.
- Press " ◀/▶ " buttons to reach the desired setting.
- Press " EXIT" button to quit.

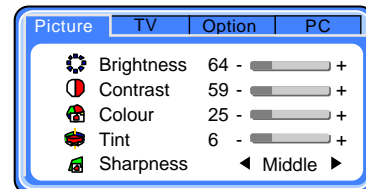

### Note:

1. In PC and YPbPr modes, only "Brightness/ Contrast" items are available.
2. "Tint" can be adjusted in NTSC system only.

## Channel Setting --- Auto Searching

You can set TV program list with Auto Searching function quickly.

- ❶ Press the "MENU" button to select "TV" mode.
- ❷ Press the "▲/▼" buttons to select "Channel Preset".



- ❸ Press the "▶" button to enter "Channel Preset".
- ❹ Press the "▲/▼" buttons to select "Auto Searching".

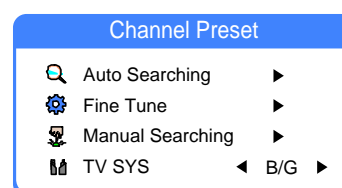

- ❺ Press "▶" button, the TV will search channels automatically. All channels will be saved once searching finished, and the TV will display the program of channel 0. In the course of auto searching, you can press "EXIT" to stop the searching process.

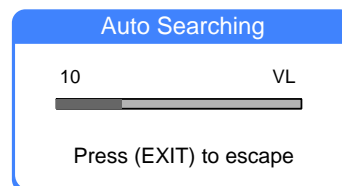

## Channel Setting --- Fine Tune

"Fine tune" helps you adjust specific programs image and sound quality.

- ❶ Press the "MENU" button to select "TV" mode.
- ❷ Press the "▲/▼" buttons to select "Channel Preset".



- ❸ Press the "▶" button to enter "Channel Preset".
- ❹ Press the "▲/▼" buttons to select "Fine Tune".

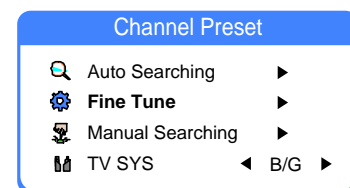

- ❺ Select "Fine Tune" and press "▶" button to enter the item . Press "◀/▶" buttons to get satisfying effect, and press "EXIT" to quit Fine Tune.

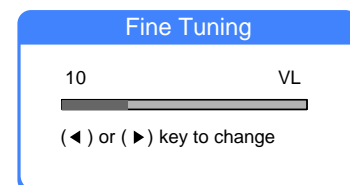

## Channel Setting --- TV system switch

You can also set program list one by one by "Manual searching" function.

- ❶ Press the "MENU" button to select "TV" mode.
- ❷ Press the "▲/▼" buttons to select "Channel Preset".



- ❸ Press the "▶" button to enter "Channel Preset".
- ❹ Press the "▲/▼" buttons to select "Manual Searching".

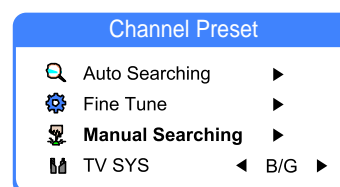

- ❺ Press the "▶" button to enter "Manual Searching".
- ❻ Press "▲/▼" buttons to change frequency band, and press "◀/▶" buttons to search channels, when a channel is found, the searching process will stop, the channel will be saved with the current channel number.

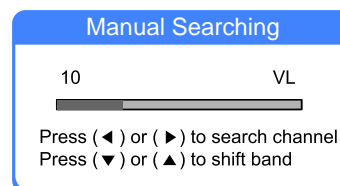

If the program is not your expected one, please press "◀/▶" buttons to continue the searching.

Press "EXIT" to quit "Manual Searching" mode .

## Channel Setting --- TV system switch

You can change TV system by yourself if necessary.

- ① Press the "MENU" button to select "TV" mode.
- ② Press the "▲/▼" buttons to select "Channel Preset".



- ③ Press the "▶" button to enter "Channel Preset".
- ④ Press the "▲/▼" buttons to select "TV SYS".
- ⑤ Press "◀/▶" buttons and choose the suitable system for local TV signal: B/G , D/K.



**Note:**

The default setting complies with the local TV broadcasting system.

### Channel Setting --- Channel Exchange

If you'd like to exchange the two channels, please use "Channel Exchange".

- ❶ Select current channel from one of the two channels to be exchanged. Press the "MENU" button to select "TV" mode.
- ❷ Press "▲/▼" buttons to select "Channel Exchange".
- ❸ Press "▶" button to enter the menu. Input the exchange channel number (the maximum number is 159), then press "▼" button to select "OK", press "ENTER" button to save your setting, then the two channel numbers are changed.
- ❹ Select "Cancel" and press "ENTER" button to quit "Channel Exchange" mode.

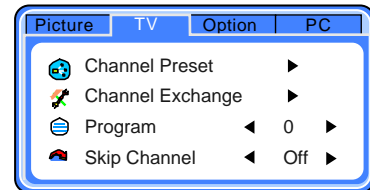

For example:

If you want to exchange channel 5 and channel 1, move to channel 5 at first. Input "1" with the numerical buttons in channel exchange window. Select "OK", and press "ENTER" button to confirm.

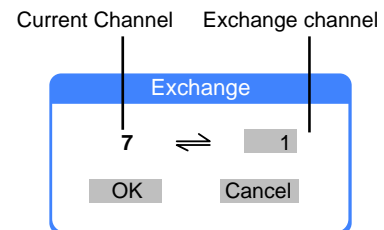

### Channel Setting --- Skip Channel

If you'd like to skip a channel automatically when you browse program by pressing "CH+/-" button, please use this function.

- ❶ Press the "MENU" button to select "TV" mode.
- ❷ Press the "▲/▼" buttons to select "Program".
- ❸ Press "◀/▶" buttons to select a program number.
- ❹ Then select "Skip Channel" item, press "◀/▶" buttons to set the option "On". Then, the channel will be hidden, when you browse channel by pressing "CH+/-" button.
- ❺ If you want to cancel "Skip Channel" mode, please set "Off" on the the "Skip Channel" item.



You can skip one channel or many channels at the same time, but you can still browse all programs by using "CH-LIST" button when "Skip Channel" is on.

### Option Setting --- OSD setting

If you want to change the OSD setting, please enter this menu.

- ① Press "MENU" button to select "Option" mode.
- ② Select "OSD Set" item, press "▶" button to enter.
- ③ Press "▲/▼" buttons to select the sub item.
- ④ Press "◀/▶" buttons to change the setting.

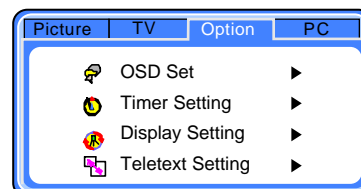

Six options of OSD Language:  
English / French / Spanish / Russian / Chinese / Arabic.

Nine options of OSD Position:  
Upper left / Upper centre / Upper right / Middle left /  
Centre / Middle right / Lower left / Lower centre / Lower right.

Two options of OSD Background: Opaque / Translucent.

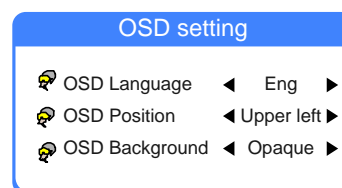

### Option Setting --- Timer setting

The TV set can be set to turn ON/OFF automatically as follows.

- ① Press "MENU" button to select "Option" mode.
- ② Press "▲/▼" buttons to select the sub item.
- ③ Select "Timer Setting" item, press "▶" button to enter.
- ④ Press "▲/▼" buttons to select the sub items.
- ⑤ Press "◀/▶" buttons to change the setting.

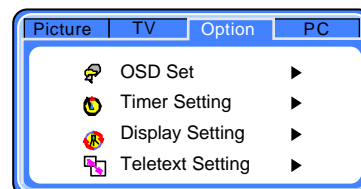

Each item is described below:

**Sleep time:** Press "◀/▶" buttons repeatedly and cycle through the preset time intervals (10, 20, 30, 60, 90, 120, 180, 240min), the TV automatically switches to standby mode when the timer reaches 0.

**Wake up timer:** If the timer is not yet set, **Off** is displayed.

**Wake up time:** You can set the specific time to wake up your TV. Only valid when Wake up timer is on.

**Current time:** Just enter the current time.

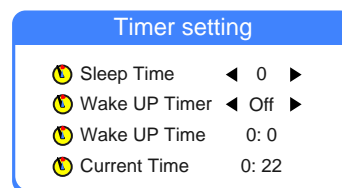

## Option Setting --- Colour Temperature Adjust

You can change colour temperature to get a better image effect according to the current circumstance.

- ❶ Press "MENU" button to select "Option" mode.
- ❷ Press "▲/▼" buttons to select "Display Setting".

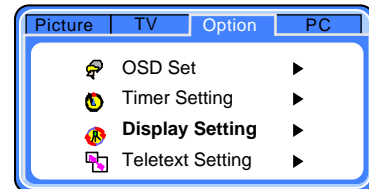

- ❸ Press "▶" button to enter the sub item.
- ❹ Press "◀/▶" buttons to Select "Color Temperature".

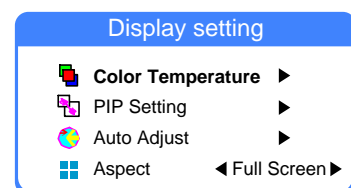

- ❺ Press "▶" button to enter the menu.
- ❻ Press "◀/▶" buttons to change the setting.

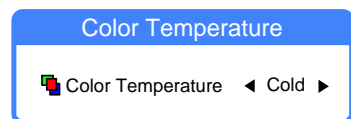

**Note:**

You have four options: Cold, Normal, Warm and User mode.

When you select "User Mode", the parameters of R,G,B can be adjusted by "◀/▶" buttons.

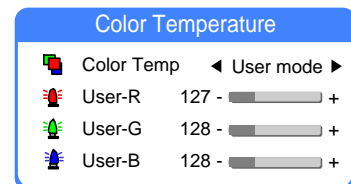



## PIP Function

PIP means picture in picture, the unit can display a sub window on the screen, which displays the program from another video source. This feature is valid when Main Window is in PC mode. You can watch TV or other video on the sub window.

PIP

Please make sure TV set is in PC mode first.  
Press "PIP" button to display the "Sub Source" Menu:



Press the direction buttons to select the source of sub window.  
Press "ENTER" button to enter the menu.

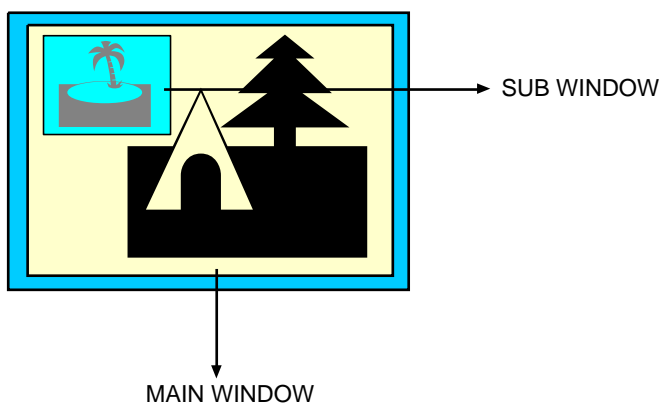

\* The input signal of Main Window should be:

1. 1024 x 768 60Hz, PC signal
2. 800 x 600 60Hz, PC signal
3. 640\*480 60Hz, PC signal
4. 480P, DVD player VGA signal 60Hz
5. 576P, DVD player VGA signal 50Hz

## Display Performance Adjust

In "PIP" mode, you can adjust sub window as follows.

- 1 Press the "MENU" button to select "Option" mode.
- 2 Press the "▲/▼" buttons to select "Display Setting".

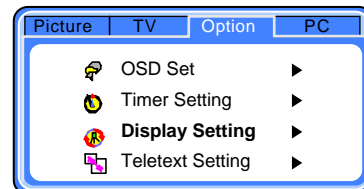

- 3 Select "PIP Setting" with "▲/▼" buttons and press "▶" button to enter.

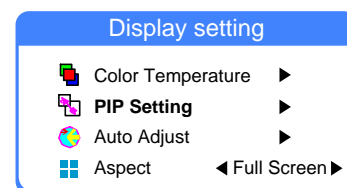

- 4 Press "▲/▼" buttons to select the sub menu.
- 5 Press "◀/▶" buttons to change the setting.

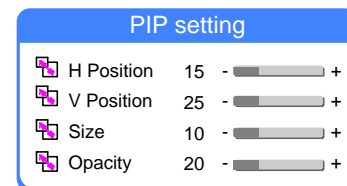

**Note:**  
The "PIP Setting" is valid only in "PIP" mode.

## Option Setting --- Auto Adjust

You can use this function to adjust the display setting automatically.

- ❶ Press "MENU" button to select "Option" mode.
- ❷ Press "▲/▼" buttons to select "Display Setting".
- ❸ Press "▶" button to enter.

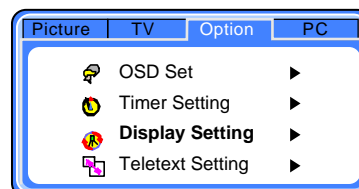

- ❹ Press "▲/▼" buttons to select "Auto Adjust".
- ❺ Press "▶" button to enter, then the TV will be in best performance after "Auto Adjust".

**Note:**

The "Auto Adjust" setting is valid only in PC mode.

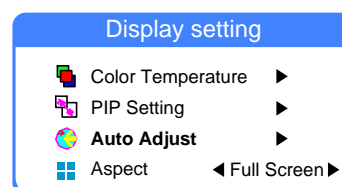

## Option Setting --- Aspect

You can adjust display aspect by using this function.

- ❶ Press "MENU" button to select "Option" mode.
- ❷ Press "▲/▼" buttons to select "Display Setting".
- ❸ Press "▶" button to enter.

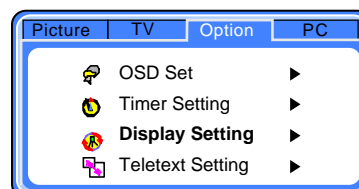

- ❹ Press "▲/▼" buttons to select "Aspect" in the display setting item.
- ❺ Press "◀/▶" buttons to change the aspect setting: (Five options: Full Screen/Normal/Wide/Cinema/Sub title). The current aspect will be changed accordingly. Press "IMAGE" button on the remote control continually to swap modes.

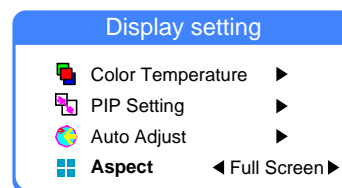

**Note:**

"Aspect" option haven't that in PC/YPbPr modes.

## Option Setting -- Teletext Setting

In Teletext mode, you can enter the menu and set Teletext language and region.  
For the other operations, please refer to page 32.

- ❶ Press "MENU" button to select "Option" mode.
- ❷ Press "▲/▼" buttons to select "Teletext Setting".
- ❸ Press "▶" button to enter.

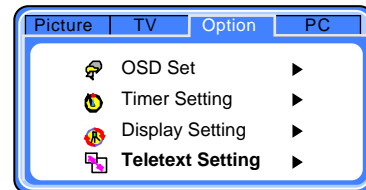

- ❹ Press "▲/▼" buttons to select the item to be changed.
- ❺ Press "◀/▶" buttons to adjust the setting.
- ❻ Press "EXIT" button to quit.

Five options of language: English / Russian / Spanish /  
French / Arabic.

Two options of regions: West/East.

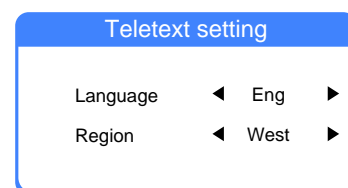

## PC Mode

Note: You should set the video signal to "PC" mode before adjusting PC mode setting.

- ❶ Press "MENU" button to enter " PC " mode.
- ❷ Press " ▲/▼ " buttons to select the item to be changed.
- ❸ Press " ◀/▶ " buttons to adjust the setting.

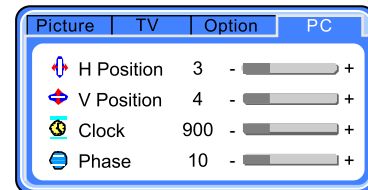

Each item is described below:

H Position: Press "▲/▼" buttons to move the image left or right.

V Position: Press "◀/▶" buttons to move the image up or down.

Clock: To adjust the horizontal frequency of the image.

Phase: To adjust the image phase.

# Functional Button Instruction

---

## Mute

MUTE



- Press the button to mute audio, press again to resume.

## Volume Adjustment

VOL+/-



- Press "VOL+" button to increase the volume;
- Press "VOL-" button to decrease the volume.

## Use the numerical buttons to select the channel directly



- Press this button one time to display "--" on the screen, the channel range will be 00-99. Use numerical buttons to enter two-digit channel number..



- Double press this button to display "---" on the screen, the channel range will be 000-159. Use numerical buttons to enter three-digit channel number.

## Channel Shift

CH+/-



- In TV mode, press "CH+" button to select next channel, and press "CH-" button to select prior channel.

## Return to previous channel



- Press the button to return to the previous channel which you were watching just now.

For example:

Channel 5 is the previous one you just watched, and channel 10 is the current one you are watching. If you press the button, the TV set will skip to channel 5. Press it again to return to channel 10.

# Functional Button Instruction

## Browse the channel list

- CH-LIST ● Press "CH-LIST" button, the Channel list will be displayed on screen.



Channel list	
0 CCTV5	5 CV
1 CCTV1	6 CCT
2 CCTV2	7 CC
3 CCTV3	8 CTV2
4 CCTV4	9 CC3

Current channel

Use direction buttons to select specific channel. Use "Page Up" and "Page Down" button to switch the listing page. Press the "EXIT" button to quit.

## Rename Channel

**You can rename the channel when you are browsing the channel list.**

- CH-LIST ● Press "CH-LIST" button, the Channel list will be displayed on screen.



Channel list	
0 CCTV5	5 CV
1 CCTV1	6 CCT
2 CCTV2	7 CC
3 CCTV3	8 CTV2
4 CCTV4	9 CC3

Use direction buttons to select specific channel.





- Press "CH-LIST" button again, the Rename Channel window will be displayed on the screen as follows:

Rename channel	
<b>Rename</b>	CC
Save	Cancel

After inputting the channel name with the numerical buttons, select "Save", and press "ENTER" to confirm. Select "cancel" and press "ENTER" to quit.

**Note: You can input letters by numerical buttons on the remote control.**

For example:

If you want enter "AV01", press , twice, press  four times continuously, then enter the  once &  once . When finishing, you can save it.

# Functional Button Instruction

## Exchange Channel

### CH-LIST



- You can also exchange two channels as follows.
- Press the "CH-LIST" button ,the channel list will be displayed on the screen.

Channel list	
0 CCTV5	5 CV
1 CCTV1	6 CCT
2 CCTV2	7 CC
3 CCTV3	8 CTV2
4 CCTV4	9 CC3

Current channel

Use the direction buttons to choose specific channel.

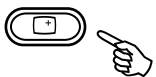

- Press left button and the following window will be displayed on the screen.

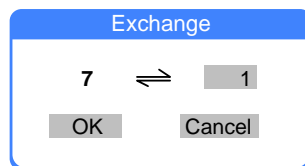

After inputting the channel number with the numerical buttons. Select "OK", press "ENTER" button to confirm and quit. Select "Cancel", press "ENTER" button to cancel and quit.

For example:

Input 10, select "OK" then press "ENTER" button to confirm.  
The channel 7 will be exchanged with channel 10.

## Display Status

### DISPLAY

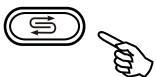

- In TV mode, press the "DISPLAY" button, the screen will display the current channel number/ channel name/skip channel status/current time.
- Press the "DISPLAY" button again, it will display the TV display mode/audio mode.
- Press the-"DISPLAY" button three times to exit the display status.

In PC mode, press the "DISPLAY" button, the screen will display resolution and frequency information.

If it is not in the above two modes, the screen will display the status of the current viewing source when you press "DISPLAY" button.

## Aspect

### ASPECT

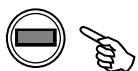

- Press "ASPECT" button, the following window will be displayed on the screen.



Press direction buttons to select your favourite mode.  
There are five options: Full Screen/Normal/Wide/Cinema/Sub title.

**Note: In PC and YPbPr mode, only "Full Screen/Normal" items are available.**



# Functional Button Instruction

## Freeze Image

FREEZE



Press the button to freeze the current image, press it again to exit the freeze mode.

Note: Not available in PC&YPbPr modes.

## Image effect adjustment

IMAGE



- After pressing "IMAGE" button, the following window will be displayed on the up-left corner of the screen:

Image effect ◀ Bright ▶

Press direction buttons or "IMAGE" button to select your favourite image mode. Four options: Bright / Standard / Mild and User mode.

Note: Not available in PC&YPbPr modes.

## Sound mode adjustment

AUDIO



- Press "AUDIO" button to enter the sound effect setting as follows:

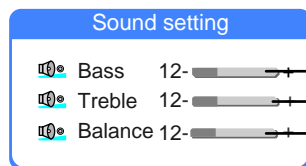

Press "▲/▼" buttons to select specific item.  
Press "◀/▶" buttons to adjust.

## Clock setup

SLEEP



- Press "SLEEP" button to set the sleeping clock as follows:

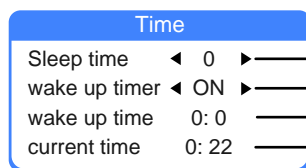

Use "◀/▶" buttons to set the sleeping time  
Use "◀/▶" buttons to set wake up timer.

Use "▲/▼" buttons to choose hour/ minute,  
Use "◀/▶" buttons to set hour/ minute.

Note: You can set the waking up ring only when wake up timer is open.

## Dual sound

DUAL I/II



- When in TV mode, you can choose between Stereo and Mono sound during stereo transmission or choose between Mono / Dual I / Dual II during dual sound transmission.

# Teletext

---

Teletext is an information system broadcast by certain channels which can be consulted like newspaper. It also offers access to subtitles for viewers with auditive problems or those who are not familiar with the transmission language (cable networks, satellite channels, etc.).

## Teletext Language Selection.

The default Teletext Language is English. If the Teletext language is not English in your selection, please kindly change the language according to the instruction on Page 26.

## TEXT/MIX

Press the Text/Mix button to activate the Teletext mode. Press again to view the TV program the teletext page. You can return to normal viewing by press the Text/MIX button for the third time.

## LIST/FLOF

Press the List/FLOF button to enter the List mode. Press again to exit List mode.

## SIZE

Repeatedly pressing the SIZE button doubles the character size in the following order: upper half of the page -> Lower half of the page -> Return to normal size.

## REVEAL

Press the button once to reveal hidden information (solutions to puzzles, riddles, etc). This button is applicable only to teletext page with puzzles, riddles, etc. The image will disappear in 3 seconds.

## SUBPAGE --- Viewing of subpage.

Pressing the subpage button to enter the subpage mode. You can use the numerical buttons directly enter the page number. Then the subpage will be displayed. To exit, press subpage button again.

## COLOUR BUTTONS IN TOP/FLOF/LIST TELETEXT

Red, green, yellow and cyan fields are shown at the bottom of the screen.

TOP or FLOF teletext (FASTEXT) is transmitted by the station, by pressing the corresponding colour button on the remote controller, you can select the desired page easily.

# Teletext

---

## STORE

You can store four page numbers in the current channel by pressing Store and numerical buttons.

1. Select the LIST mode using the List/Flof button, then four 3-digit numbers are displayed in different colours.
2. Press the colour buttons of corresponding page that will be replaced.
3. Enter the new page number using the numerical buttons.
4. Press the STORE button until the corresponding blocks blink.

### Notes:

1. Up to four different teletext pages can be stored from channel 0 to channel 40.
2. The remaining channels, channel 41 to channel 159 and AV, all share a common memory: all of the 4 pages for each of these channels will be the same as those of the lastly stored 4 pages in memory for any channel among these channels.

## HOLD

Press the button once to hold page and a second time to release holding of page.

## Selecting a page by numeric buttons directly

You can select a page by numerical buttons directly in TEXT mode.

## PAGE DOWN/UP

Use these direction buttons to page up/down.

## WATCHING TELEVISION DURING TELETXT MODE

Some pages are continually updated, for example, stock market reports, sports announcements, and the latest news.

If you want to watch television and stay informed at the same time, press CANCEL button. Press the CANCEL button again, the teletext page appears with the updated information.

## REMOTE CONTROL

You can adjust volume directly using "VOL+/-" and "MUTE".

### Notes:

1. The buttons for Teletext function are invalid when menu is being displayed. You can activate the teletext function buttons by pressing the "EXIT" or "Text/Mix" button.
2. Image freezing function is invalid in TTX/MIX mode. The image freezing mode will exit automatically when entering Text mode.

# Play Flash Memory Card

---

## Play Flash Memory Card

You can enjoy the pictures in your flash card with the TV directly. Several formats files can be played.

## Flash Memory Card

Flash memory card is a small, portable and universal IC recordable card, which has larger memory capacity than floppy disk.

## About E-album

1. Your TV set can display 900 million pixels JPEG picture.
2. JPEG expresses Joint Photographic Experts Group.

## Picture format:

--Compress format should be: JPEG

--Files format should be: JPG

## Music format:

--MP3, WMA

## Insert and pull out the card

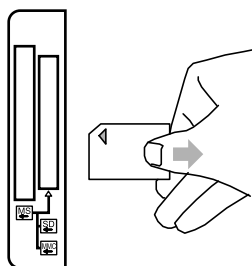
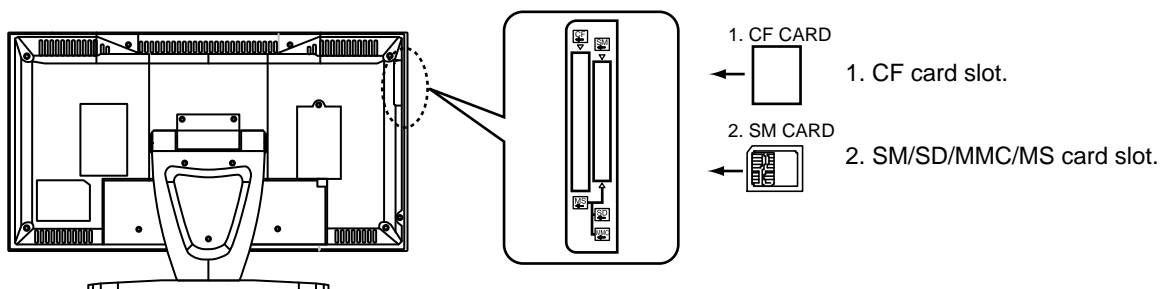

Please insert the card into the card slot following the above illustration. Wrong action may damage the card.

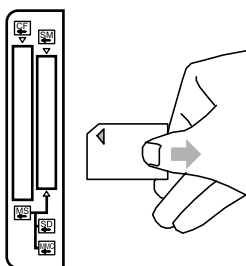

Please pull the card out following the above illustration. Be tender and careful with your card.

# Play Flash Memory Card

## Play Music

1. Insert flash memory card into the card slot.  
Press the "SOURCE" button to display the main menu and select "Flash Card" with direction buttons. Then press "ENTER" button to confirm.
2. The following menu will be displayed on the screen:

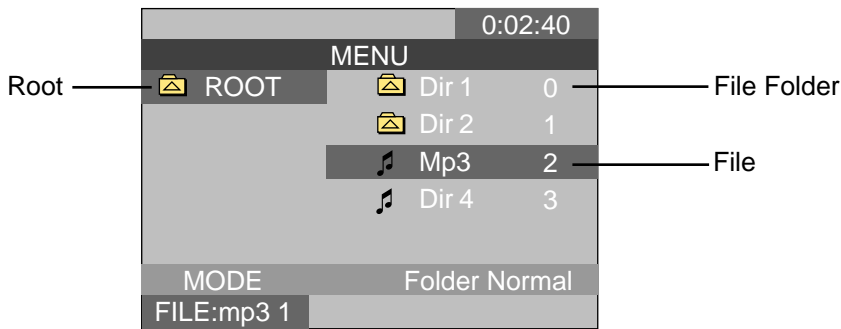

3. Your TV set will play the files at the root. To enter the folder, press "■" button.  
For example select Dir2, then press "ENTER" button to display the following menu.

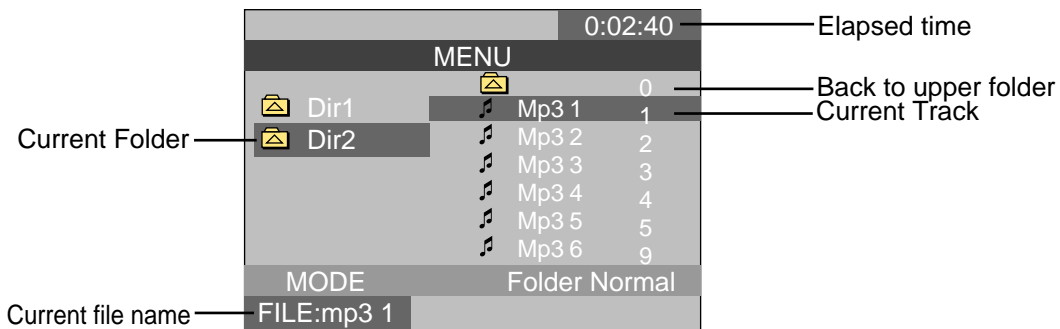

If you want to select other tracks, press "PAGE" button directly, or you can press "▲/▼" buttons to select the desired item in the stop mode.  
Then press "▶" or "ENTER" button to play single.

4. Select play mode:  
Press "▶" button to switch "Mode" in stop mode. Press "ENTER" button to select.  
The following modes are available: Folder Normal, Folder Repeat, Single Track, Repeat single

  - Folder Normal ---- Play track from the selected one to the last one, stop automatically when finished;
  - Folder Repeat ---- Play the track from the list circularly;
  - Single track ---- Only play the desired item then stop;
  - Repeat single ---- Repeat the current selected track.

# Play Flash Memory Card

Select a folder -- Dir1, then press " ENTER " button and the screen will display as follows.

MENU		
Dir1	..	0
Dir2	001	1
JPEG	002	2
Dir4	003	3
	004	4
	005	5
	006	6
MODE		Folder Normal

## PLAY/PAUSE



- Press " ▶/|| " button to pause the slide show.
- Press " ▶/|| " again to continue the slide show.
- Press "PAGE" button to view previous or next picture.
- Press " ■ " button to stop slide show and return to the menu.

## ROTATE

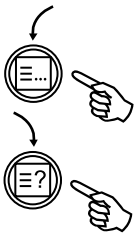

- Two Rotate modes you can select. Anti-clock wise and clock wise.
- Press this button to rotate the picture, the picture will rotate 90 degrees for each press.
  - Press this button to rotate the picture deasil, the picture will rotate 90 degrees for each press.

## DIGEST

DIGEST

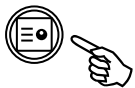

- When playing the picture, press this button to display 9 small pictures on the screen.
- Select one of the 9 picture with direction buttons, press " ▶/|| " button to enlarge the picture to the whole screen.
- In " DIGEST" mode, press " PAGE" button to view previous 9 pictures or next 9 pictures .

## ZOOM

ZOOM

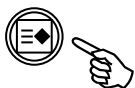

- When your set " play the picture", press "ZOOM" button ,the picture will shift as follows:



- In zoom mode, press direction buttons to move the picture.

# Stand Uninstallation

---

Please follow the instructions given.

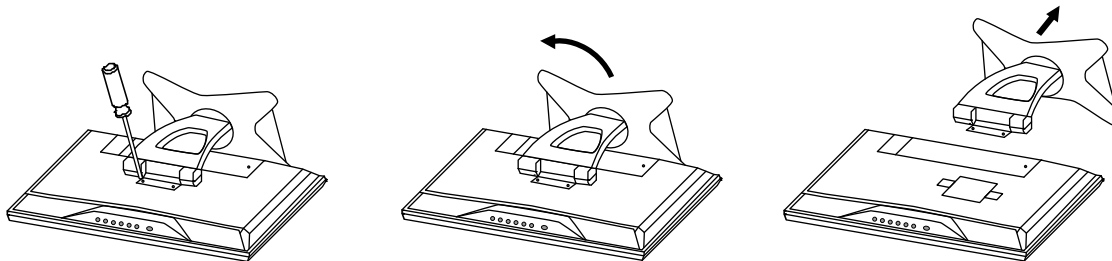

1. Lay the LCD TV/Monitor face-down on a flat surface with a cushion or other soft materials to protect the screen.
2. Remove all cables connected on the TV/Monitor
3. Remove the four screws and then remove the stand from the LCD TV/Monitor.
4. Reconnect all cables you removed in step 2.
5. Now you are ready to install Wall/Arm mounting device.

# Maintenance

---

## Care for your TV

Early malfunctions can be prevented. Careful and regular cleaning can extend the amount of time you will have with your TV. Be sure to turn the power off and pull out the plug before you begin any cleaning.

## Screen Cleaning

1. Here is a great way to keep the dust off your screen for a while. Wet a soft cloth in a mixture of lukewarm water and a little fabric softener or dish washing detergent. Wring the cloth until it is almost dry, and then use it to wipe the screen.
2. Make sure not be excess water put on the screen, let it air-dry before you turn on your TV.

## Cabinet Cleaning

1. Use a soft cloth with a mild soap solution to wipe the cabinet.
2. Rinse the cloth and wipe the cabinet again.
3. Let the cabinet air-dry before turning your TV on.

## Extended Absence

If you leave your TV unused for a long time (such as a vacation), it is a good idea to unplug the power cord to protect against possible damage from lightning or power surges. If you use an antenna, you may also need to disconnect it from the back of your TV before leaving.



# Trouble Shooting

---

Please read this user's manual before using the TV set. If you have any troubles in using this TV set, try to solve it by the suggestions mentioned below. If you can not remove the trouble after adopting corresponding suggestions, please contact the technical service centre or dealer authorised by us. For the sake of your safety, please do not open the cover and repair by yourself, or it may cause further damage to the TV set, electric shock or fire.

There is no sound but picture is normal

1. Ensure that the volume is turned down to the least.
2. Check whether the TV set works in mute mode.

There is no picture or sound

1. Ensure that the power cord has a good connection.
2. Ensure that the power switch is on.
3. The contrast and the brightness are adjusted properly.

Picture is black and white or colourless

1. Adjust the colour setup.
2. Check whether the broadcast system selection is correct.

Picture is blurred or there is snowflake or noise

1. Adjust direction and position of the right antenna.
2. The feedback cord of antenna is damaged or broken.

Sound and picture are interfered

1. Check whether the TV set is very near to other electrical appliance. If so, remove it.

Picture is not stable and rolling in PC mode

1. Check whether the display frequencies and bandwidth of computer or video source are fit for TV.
2. Check the display setup of control panel in computer. If the setup is incorrect, change it by computer programming tools.

Screen displays to check signal cords

1. Check whether the signal cords are connected to PC or video source.
2. Check whether PC or video source is in work.

Remote control is insensitive or does not work

1. Check the batteries of the remote control and make sure that they are powerful and well conductive.
2. Direct the remote control to the IR sensor of the TV.
3. Check whether there are some obstacles between the remote control and IR sensor.

# Specifications

---

Power Supply	Input: AC 110 - 240V, 50Hz/60Hz Output: DC 12V / 4A
Power Consumption	Standby: <3W Max: 50W
Frequency	Horizontal: 30 - 80KHz Vertical: 50 - 75Hz
Colour System	NTSC / PAL/SECAM
VGA	Sync.: H/V Separate, TTL, P. or N. Video Signal: 0.7Vp-p, 75ohm
Audio	Audio in: RCA JACK (MR) , 0.5Vrms (-9dB) Frequency Response: 80Hz-15KHz (at -3dB) Earphone out: Max. 10mW Output (3.5Ø Stereo Jack, 32Ω)
Environmental Considerations	Operating Temperature: 5V -40 <sup>0</sup> C Operating Humidity: 10%-80% Relative Humidity
Specification of Monitor	Display Colour: 16.2M colours Resolution: 1280 x 768 pixel Pixel Pitch: 0.2895mm (H) x 0.2895mm (V) View angle: 80/80/70/80 (L / R / T / B) Contrast: 450:1 Brightness: 500 cd/m <sup>2</sup> Response Time: 16 ms
Size	Unit Dimension: 301mm x 546mm x 57.7mm Screen Dimension: 370 (H) x 222 (V) mm
Weight	Gross Weight: 8.8kg      Net Weight: 5.9kg
Accessories	S-Video cord x 1 /Adapter x 1 /Power cord x 1 /VGA cord x 1 / User's manual x 1 Remote control x 1 /Battery x 2 / Wall Mounting Bracket x 1

Specifications are subject to change without notice.  
Weight and dimensions are approximate.

PALSONIC CORPORATION PTY LTD  
1 JOYNTON AVENUE  
WATERLOO NSW 2017 AUSTRALIA  
TEL: (02) 9313 7111  
FAX: (02) 9313 7555  
[www.palsonic.com.au](http://www.palsonic.com.au)

**PALSONIC CUSTOMER SERVICE  
TELEPHONE  
AUSTRALIA: 1300 657 888**

FKV2.037.880SSE