



# DLP® HIGH-DEFINITION TELEVISION MODELS

---

## C9 Series

## 737 Series



## 837 Series

---

# OWNER'S GUIDE

- **Guidelines for setting up and using your new widescreen TV start on page 7.**
- For questions:
  - Visit our website at [www.mitsubishi-tv.com](http://www.mitsubishi-tv.com).
  - E-mail us at [MDEAservice@mdea.com](mailto:MDEAservice@mdea.com).
  - Call Consumer Relations at 800-332-2119.
- For information on **System Reset**, please see the back cover.
- To order replacement or additional remote controls or lamp cartridges, visit our website at [www.mitsuparts.com](http://www.mitsuparts.com) or call 800-553-7278.
- **837 Series.** IR emitter cables for NetCommand home-theater control are available for purchase from Mitsubishi. Call 800-553-7278 and request either part number 242D483020 (two-ended cable) or part number 299P254020 (four-ended cable).

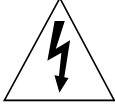

	<b>CAUTION</b> RISK OF ELECTRIC SHOCK DO NOT OPEN	
CAUTION: TO REDUCE THE RISK OF ELECTRIC SHOCK, DO NOT REMOVE COVER (OR BACK). NO USER SERVICEABLE PARTS INSIDE. REFER SERVICING TO QUALIFIED SERVICE PERSONNEL.		

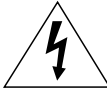
 The lightning flash with arrowhead symbol within an equilateral triangle is intended to alert the user of the presence of uninsulated "dangerous voltage" within the product's enclosure that may be of sufficient magnitude to constitute a risk of electric shock to persons.

 The exclamation point within an equilateral triangle is intended to alert the user to the presence of important operating and maintenance (servicing) instructions in the literature accompanying the product.

**MAINS DISCONNECTION:** The mains plug is used as the disconnect device. The disconnect device shall remain readily operable.

**Stand Requirement**

CAUTION: Use these Mitsubishi TV models only with the Mitsubishi stand models shown here. Other stands can result in instability and possibly cause injury.

TV Model	Stand Model
WD-60C9, WD-65C9 WD-60737, WD-65737 WD-65837	MB-S60/65A
WD-73C9 WD-73737 WD-73837	MB-S73A

**82-inch TVs: Mitsubishi does not design, manufacture, or sell matching bases for 82-inch televisions (WD-82737, WD-82837). When selecting a stand, base, or other furniture to support the TV, please make sure it is designed with the appropriate dimensions for stability and to support the TV's total weight as well as the weight of any additional equipment you plan to store.**

**TV WEIGHT:** This TV is heavy. Exercise extreme care when lifting or moving it. Lift or move the TV with a minimum of two adults. To prevent damage to the TV, avoid jarring or moving it while it is turned on. Always power off your TV, unplug the power cord, and disconnect all cables before moving it.

**WARNING:** To reduce the risk of fire or electric shock, do not expose this apparatus to rain or moisture.

**WARNING:** This product contains chemicals known to the State of California to cause cancer and/or birth defects or other reproductive harm.

**FCC Declaration of Conformity**

Product: Projection Television Receiver  
 Models: WD-60C9, WD-65C9, WD-73C9  
 WD-60737, WD-65737, WD-73737,  
 WD-82737  
 WD-65837, WD-73837, WD-82837  
 Responsible Party: Mitsubishi Digital Electronics  
 America, Inc.  
 9351 Jeronimo Road  
 Irvine, CA 92618-1904  
 Telephone: (800) 332-2119

This device complies with Part 15 of the FCC Rules. Operation is subject to the following two conditions:

- (1) This device may not cause harmful interference, and
- (2) This device must accept any interference received, including interference that may cause undesired operation.

**Note:** This equipment has been tested and found to comply with the limits for a Class B digital device, pursuant to part 15 of the FCC Rules. These limits are designed to provide reasonable protection against harmful interference in a residential installation. This equipment generates, uses and can radiate radio frequency energy and, if not installed and used in accordance with the instructions, may cause harmful interference to radio communications. However, there is no guarantee that interference will not occur in a particular installation. If this equipment does cause harmful interference to radio or television reception, which can be determined by turning the equipment off and on, the user is encouraged to try to correct the interference by one or more of the following measures:

- Reorient or relocate the receiving antenna.
- Increase the separation between the equipment and the receiver.
- Connect the equipment into an outlet on a circuit different from that to which the receiver is connected.
- Consult the dealer or an experienced radio/TV technician for help.

**Changes or modifications not expressly approved by Mitsubishi could cause harmful interference and would void the user's authority to operate this equipment.**

Features and specifications described in this owner's guide are subject to change without notice.

# Contents

---

## **Important Information About Your TV**

Installation and Operating Notes . . . . .	4
Important Safety Instructions. . . . .	5
Special Features of Your TV. . . . .	6

---

## **1 Basic Setup and Operation**

Package Contents . . . . .	7
Before You Begin . . . . .	7
First-Time Power-On. . . . .	7
TV Controls . . . . .	8
Setting Up TV Inputs. . . . .	10
Basic TV Operation. . . . .	12

---

## **2 TV Connections**

Before You Begin . . . . .	14
Inputs and Outputs. . . . .	15
Y Pb Pr Component Video Device . . . . .	17
HDMI Device . . . . .	17
DVI Video Device . . . . .	18
Composite Video Device. . . . .	18
Antenna or Cable TV Service. . . . .	18
VCR or DVD Recorder to an Antenna or Wall Outlet Cable . . . . .	19
VCR or DVD Recorder to a Cable Box . . . . .	19
A/V Receiver . . . . .	20
A/V Receiver with HDMI Output. . . . .	20

---

## **3 Using TV Features**

Selecting an Input . . . . .	21
Sleep Timer . . . . .	21
ChannelView Channel Listings. . . . .	22
Redirecting Audio Output . . . . .	22
Controlling A/V Receiver Sound Volume . . . . .	22
Status Display . . . . .	23
TV Signals and Display Formats. . . . .	24
3D Video . . . . .	25
Using the TV with a Personal Computer . . . . .	26
Camera Images and Music Files . . . . .	28
Introduction to Home-Theater Control . . . . .	31

---

## **4 TV Menus**

Main Menu. . . . .	32
Menu Navigation . . . . .	32
Adjust . . . . .	33
Captions . . . . .	37
Initial. . . . .	38
Inputs . . . . .	40
Lock . . . . .	42

---

## **5 NetCommand IR Control**

About NetCommand IR Control . . . . .	45
IR Emitter Placement . . . . .	46
Initial NetCommand Setup . . . . .	47
Operating NetCommand-Controlled Devices . . . . .	48

---

## **6 NetCommand IR Control of an A/V Receiver**

Controlling an A/V Receiver after NetCommand Setup . . . . .	51
Setting Up A/V Receiver Control Power and Volume . . . . .	52
Automatic Audio or Audio/Video Switching . . . . .	53

---

## **Appendices**

Appendix A: Bypassing the Parental Lock . . . . .	57
Appendix B: Programming the Remote Control . . . . .	59
Appendix C: HDMI Control of CEC Devices . . . . .	66
Appendix D: TV Care Lamp-Cartridge Replacement and Cleaning . . . . .	69
Cleaning Recommendations . . . . .	71
Care of the Remote Control . . . . .	71
Appendix E: Troubleshooting . . . . .	72

---

## **Trademark and License Information . . . . . 79**

## **Mitsubishi TV Software . . . . . 80**

## **Warranty . . . . . 81**

## **Index . . . . . 83**

## Important Information About Your TV

### For Your Records

Record the model number, serial number, and purchase date of your TV. The model and serial numbers are on the back of the TV. Refer to this page when requesting assistance with the TV.

**MODEL NUMBER** \_\_\_\_\_

**SERIAL NUMBER** \_\_\_\_\_

**PURCHASE DATE** \_\_\_\_\_

**RETAILER NAME** \_\_\_\_\_

**LOCATION** \_\_\_\_\_

### Installation and Operating Notes

*Custom cabinet installation must allow for proper air circulation around the television.*

**NOTE TO CATV SYSTEM INSTALLER:** THIS REMINDER IS PROVIDED TO CALL THE CATV SYSTEM INSTALLER'S ATTENTION TO ARTICLE 820-40 OF THE NEC THAT PROVIDES GUIDELINES FOR THE PROPER GROUNDING AND, IN PARTICULAR, SPECIFIES THAT THE CABLE GROUND SHALL BE CONNECTED TO THE GROUNDING SYSTEM OF THE BUILDING, AS CLOSE TO THE POINT OF CABLE ENTRY AS PRACTICAL.

### Internal Fans

Internal cooling fans maintain proper operating temperatures inside the TV. It is normal to hear the fans when you first turn on the TV, during quiet scenes while viewing the TV, and for a short time after shutting off the TV. You may notice louder fan noise about 30 seconds after shutting off the TV and while using the **Bright Lamp Mode**.

### Lamp Replacement

For lamp-replacement instructions, see Appendix D.

#### To Order a Replacement Lamp Under Warranty

Call (800) 553-7278. Please have model number, serial number, and TV purchase date available.

**Important: All lamps replaced under warranty must be returned to Mitsubishi where they will be inspected for defect verification.**

#### To Purchase a Replacement Lamp After Warranty

Visit our website at [www.mitsuparts.com](http://www.mitsuparts.com) or call (800) 553-7278. Order new lamp part number 915B403001

### TV Software

Do not attempt to update the software of this TV with software or USB drives not provided by or authorized by Mitsubishi Digital Electronics America, Inc. Non-authorized software may damage the TV and will not be covered by the warranty.

# Important Safety Instructions

Please read the following safeguards for your TV and retain for future reference. Always follow all warnings and instructions marked on the television.

- 1) Read these instructions.
- 2) Keep these instructions.
- 3) Heed all warnings.
- 4) Follow all instructions.
- 5) Do not use this apparatus near water.
- 6) Clean only with dry cloth.
- 7) Do not block any ventilation openings. Install in accordance with the manufacturer's instructions.
- 8) Do not install near any heat sources such as radiators, heat registers, stoves, or other apparatus (including amplifiers) that produce heat.
- 9) Do not defeat the safety purpose of the polarized or grounding-type plug. A polarized plug has two blades with one wider than the other. A grounding type plug has two blades and a third grounding prong. The wide blade or the third prong are provided for your safety. If the provided plug does not fit into your outlet, consult an electrician for replacement of the obsolete outlet.
- 10) Protect the power cord from being walked on or pinched particularly at plugs, convenience receptacles, and the point where they exit from the apparatus.
- 11) Only use attachments/accessories specified by the manufacturer.
- 12) Use only with the cart, stand, tripod, bracket, or table specified by the manufacturer, or sold with the apparatus. When a cart is used, use caution when moving the cart/apparatus combination to avoid injury from tip-over.
- 13) Unplug this apparatus during lightning storms or when unused for long periods of time.
- 14) Refer all servicing to qualified service personnel. Servicing is required when the apparatus has been damaged in any way, such as power-supply cord or plug is damaged, liquid has been spilled or objects have fallen into the apparatus, the apparatus has been exposed to rain or moisture, does not operate normally, or has been dropped.



EXAMPLE OF ANTENNA GROUNDING

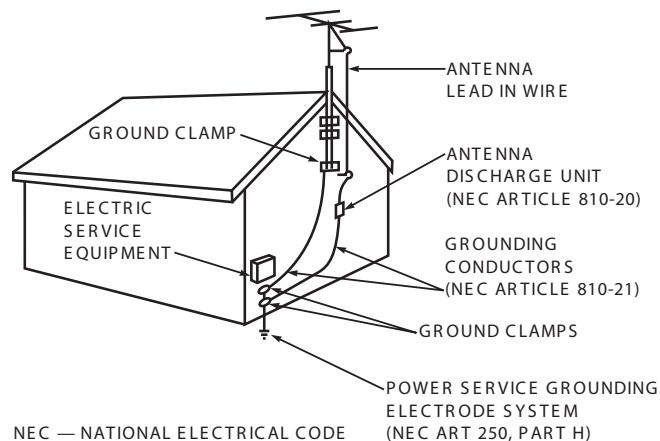

## Outdoor Antenna Grounding

If an outside antenna or cable system is connected to the TV, be sure the antenna or cable system is grounded so as to provide some protection against voltage surges and built-up static charges.

## Replacement Parts

When replacement parts are required, be sure the service technician has used replacement parts specified by the manufacturer or have the same characteristics as the original part. Unauthorized substitutions may result in fire, electric shock or other hazards.

## Special Features of Your TV

Your new high-definition widescreen television has many special features that make it the perfect center of your home entertainment system, including:

### 1080p High-Definition DLP Display System

Your Mitsubishi HDTV uses Texas Instruments Digital Light Processing™ technology for rear-projection TVs to create the picture you see on screen. All images are displayed at 1080p. The TV uses Plush 1080p@ 5G to convert lower-resolution signals to 1080p for display. The TV can also accept 1080p original signals and maintain them at 1080p through all processing until displayed.

### 3D Ready

All Mitsubishi 1080p DLP HDTV's are 3D Ready. This feature lets you experience the new 3D technologies applied to many recent movies and video games. Immerse yourself in your favorite video game, movie, or sporting event displayed in 3D.

### 16:9 Widescreen Picture Format

Enjoy a full theatrical experience in the comfort of your home. View pictures as film directors intended them. Digital TV broadcasts, DVDs and newer video game consoles support this widescreen format.

### Integrated HDTV Tuner

Your widescreen Mitsubishi HDTV has an internal HDTV tuner able to receive both over-the-air HDTV broadcasts (received via an antenna) and non-scrambled digital cable broadcasts, including non-scrambled HDTV cable programming.

### High-Definition Video Inputs

- **Component Video Inputs.** Also called Y/Pb/Pr inputs, these inputs receive standard analog video formats of 480i, 480p, 720p, and 1080i high-definition signals. This provides a high level of flexibility when connecting DVD players/recorders, cable boxes, and satellite receivers.
- **HDMI Inputs.** These inputs accept digital 480i, 480p, 720p, 1080i, and 1080p video signals plus PCM digital stereo signals. The HDMI™ inputs can also accept a variety of PC signals and resolutions.

These inputs support HDMI 1.3 Deep Color (up to 36 bits) and the **x.v.Color** extended color gamut.

Used with an adapter, these HDMI inputs also accept compatible digital DVI video signals. HDMI inputs provide additional high-performance, high-definition connections for maximum flexibility in your choice of home theater products. The HDMI inputs are HDCP copy-protection compatible.

### Easy Connect Auto Input Sensing

Easy Connect™ Auto Input Sensing automatically recognizes when you plug in a device and prompts you to assign a name to it. The TV ignores any unused inputs, so the result is an uncluttered menu where you can easily find and select connected devices by name.

### Home-Theater Control

#### HDMI Control

**Available for all models.** HDMI devices with Consumer Electronics Control (CEC) capabilities may be compatible with the TV's HDMI Control feature. Compatible devices can receive control signals through the HDMI connection, allowing the TV's remote control to operate some functions of these devices.

#### NetCommand with IR Learning

**837 Series.** Your Mitsubishi HDTV offers a new level of networking that seamlessly integrates selected older A/V products with new and future digital products. NetCommand® supports IR (infrared) control of products such as VCRs, DVD players, cable boxes, and satellite receivers. NetCommand can "learn" remote control signals directly from many devices, allowing you to create a customized NetCommand-controlled home-theater system. The necessary IR emitter cables are available for purchase separately from Mitsubishi.

### ENERGY STAR® Compliance

This TV meets ENERGY STAR® efficiency standards in all operating modes.

# 1 Basic Setup and Operation

## Package Contents

Please take a moment to review the following list of items to ensure that you have received everything.

1. Remote Control
2. Two AA Batteries
3. Basic Owner's Guide
4. HDTV Quick-Setup Guide
5. Product Registration Card

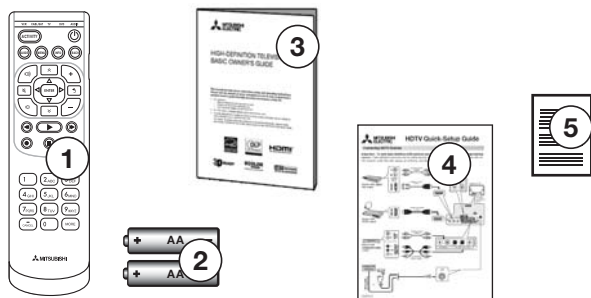

## Before You Begin

1. Review the important safety, installation, and operating information at the beginning of this book.
2. Choose a location for your TV.
  - Allow at least four inches of space on all sides of the TV to help prevent overheating. Overheating may cause premature failure of the TV as well as shortened lamp life.
  - Avoid locations where light may reflect off the screen.
  - See the stand requirements on page 2.
3. Install the batteries in the remote control.
4. Plug the TV into an AC power outlet.

## First-Time Power-On

1. Confirm that the remote control is in TV mode.
  - Press the side button once to light the mode indicator and confirm that TV mode is active.
  - To change, press the side button additional times to activate TV mode.
2. Aim the remote control at the TV and press the POWER key . Wait for the Welcome screen.
3. Press ▼ if you wish to change the menu language to Español.
4. Press ► to highlight EXIT. Press ENTER to clear the menu.

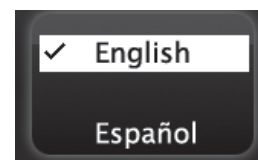
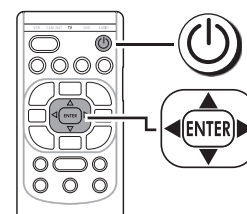
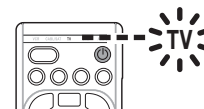
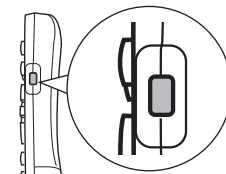

## Remote Control Batteries

1. Remove the remote control back cover.
2. Load the batteries, making sure the polarities (+) and (-) are correct. Insert the negative (-) end first.

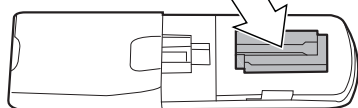
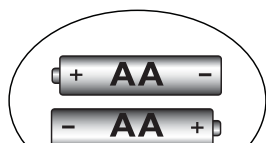
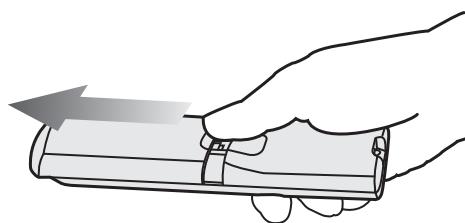

3. Slide the cover back into place.

## TV Controls

### Remote Control

**ACTIVITY** Press to select a TV activity and input. See page 21.

**GUIDE** ChannelView listings, page 22.

**MENU** TV main menu, page 32

**INFO** TV status (page 23) or TV help.

**BACK** Steps back one menu; clears the top menu or Status Display.

**VOLUME UP**

**MUTE**

**VOLUME DOWN**

Record/Playback controls for external devices  
When remote control is programmed, page 59  
HDMI control, page 68  
**837 Series:** NetCommand, page 48

**PAUSE** Freezes a broadcast TV picture.

Number/letter keys  
Channel tuning, page 12

**CANCEL** Adds a separator when entering digital channel numbers.  
Clears some menu entries.

**VCR CABL/SAT TV DVD AUDIO**  
Control-mode indicator for device type to control. Use the side button to change.

**Power** Powers TV on or off.

**Side button** sets the control mode for the type of device to operate. Set mode to **TV** for normal TV viewing.

**CHANNEL UP**

**LAST.** Goes to the previously tuned channel.

**CHANNEL DOWN**

**PAGE UP**

**ENTER** Selects a channel number or menu item.

**Navigation controls**

**PAGE DOWN**

**MORE** Displays a menu showing additional functions for the number keys.

- For the **MORE** menu in TV mode, see below.
- With remote control programmed for other device types, page 59. The **MORE** menu in other modes is specific to the device type.
- For CEC-enabled devices, page 66

The **MORE** menu in TV mode

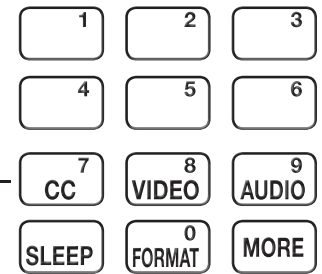

**SLEEP** Sleep Timer, page 21

**FORMAT** Picture shape (aspect ratio), page 24

**MORE** Clears the **MORE** menu.

**Note:** To operate other audio/video devices using the TV's remote control:

- See Appendix B, "Programming the Remote Control."
- For HDMI devices compatible with the TV's HDMI Control feature, see Appendix C.
- **837 Series**
  - See page 45 for NetCommand IR "Learning" of device keys.
  - For use of specific keys with NetCommand-controlled devices, see "Special Operation Methods," page 48.

**CC** Closed captions, page 37  
**VIDEO** Video adjustments, page 35  
**AUDIO** Audio adjustments, page 36



## TV Controls, continued

### TV Control Panel

Buttons on the control panel duplicate some keys on the remote control.

- Refer to **upper labels** when no TV menus are displayed.
- Refer to **lower labels** when using TV menus or after activating a special function.

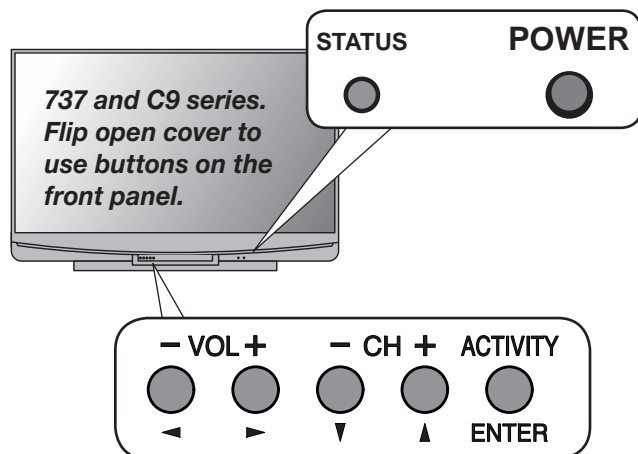

Controls on 737 and C9 series TVs. 837 series controls are similar and are located next to the **STATUS** indicator.

### STATUS Light

#### Key

- Off
- Steady On
- ◐ Slow Blinking
- ⊗ Fast Blinking

LED Color	TV Condition	Additional Information
None ○	TV is powered off.	Normal operation.
Green ●	TV is powered on.	Normal operation.
Green ◐	TV powered off, auto-on TV Timer is set.	Normal operation. TV can be turned on at any time.
Green ⊗	TV just powered off and lamp is cooling.	LED starts to blink 60 seconds after turning off TV. TV can be turned back on before blinking starts or after blinking stops, but not while the indicator is blinking. Normal operation.
Yellow ○	1. Lamp failure 2. No lamp installed.	Replace the lamp. See "Lamp-Cartridge Replacement and Cleaning" on page 69.
Red ◐	Lamp access door is open or not secure.	TV will not operate until lamp access door is secured. See "Lamp-Cartridge Replacement and Cleaning" on page 69.
Red ●	TV may require service.	Turn off the TV and unplug the set from the AC power source. Wait one minute and then plug the set back in. See Appendix E. If the red LED is still on, contact your dealer or a Mitsubishi Authorized Service Center. Go to <a href="http://www.mitsubishi-tv.com">www.mitsubishi-tv.com</a> or call 1-800-332-2119 to receive Authorized Service Center information.

### System Reset

If the TV fails to respond to the remote control, the control-panel buttons, or will not power on/off, perform System Reset. Recent setting changes made before using System Reset may be lost.

To perform System Reset, press and hold the **POWER** button on the control panel for ten seconds.

### Panel-Lock Release

- To release the Panel Lock from the TV control panel, press and hold the **ACTIVITY** button on the control panel for ten seconds. You can release the Panel Lock with the TV powered either on or off.
- To activate the Panel Lock, use the **Lock** menu, page 44.

#### If You Power Off the TV by Mistake

1. Press **POWER** again, within about 60 seconds, to have the TV come back on immediately.
2. If the status indicator starts rapidly blinking green (about 60 seconds after you shut off power), wait a few moments for the status indicator to stop blinking and press **POWER** to turn the TV on again.

## Setting Up TV Inputs

### Using the ANT (Antenna) Input

If using an antenna or direct cable service (no cable box), connect the incoming coaxial cable to the TV's **ANT** input. Refer to page 18.

You must save channels to memory with a channel scan to enable reception of all available high-definition and standard-definition digital channels. The channel scan will search for channels available locally. If you skip this step, the TV will receive only analog channels.

### Memorizing Channels with Channel Scan

#### For the ANT input

#### To start channel memorization

1. Power on the TV.
2. Press **MENU** and open the **Initial > Channel** menu.



Start channel memorization from the **Initial > Channel** menu.

3. Press **ENTER** to enter the menu.
4. Select **Ant Air** if connected to an over-the-air antenna. Select **Ant Cable** for direct cable.
5. Highlight **Scan** and press **ENTER**. Channel memorization may take up to 15 minutes to complete.

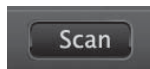
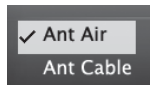

To stop channel memorization before completion, press **CANCEL**.

Use the **Initial > Channel > Edit** menu (page 39) for additional channel options, such as adding or deleting channels from memory.

### Setting Up Other Inputs

1. Connect your devices to the TV, making note of which TV input jack is used for each device. See "TV Connections," page 14, for recommendations.
2. Power on the devices to ensure detection.
3. Power on the TV.  
The TV will display the **New Device Found** screen for each new connection it detects. Learn more about Auto Input/Auto Output Sensing on the opposite page.
4. Select the device type if the device is not recognized automatically.

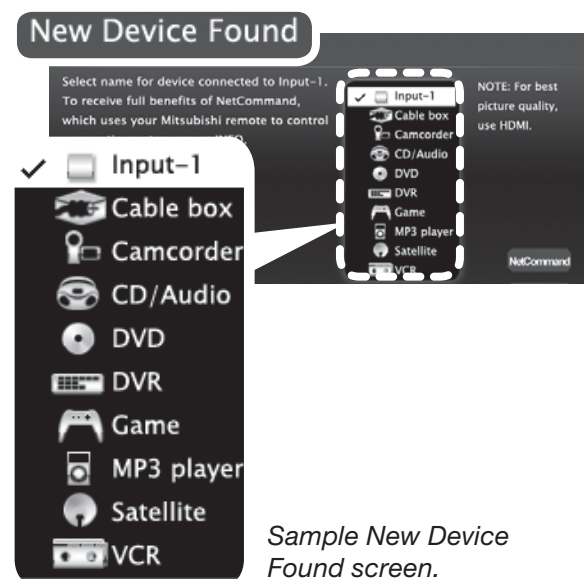

Sample **New Device Found** screen.

#### Important Note for NetCommand IR Users

**837 Series.** Be sure to select the correct device type here. Although you can change the device type later in the **Inputs > Name** menu, any "learned" NetCommand IR codes will be erased when you make the change.

5. **837 Series.** You can perform NetCommand IR "learning" after selecting the device type or at a later time when convenient. To perform now, highlight **NetCommand** and press **ENTER**. See "Initial NetCommand Setup," page 47 or "Setting Up A/V Receiver Control," page 52.
6. Press **BACK** to close the **New Device Found** screen. The TV will then display the **New Device Found** screen for the next connection it finds.

## Setting Up TV Inputs, continued

### About Auto Input Sensing/ Auto Output Sensing

This TV's Easy Connect™ Auto Input Sensing feature detects most connections automatically.

#### Auto Input/Auto Output Sensing for Most Devices

When you first connect a device, the TV will:

- Detect the connected device and automatically switch to it.
- Prompt you to identify the device type.
- 837 Series.** Prompt you to perform NetCommand set-up for the device, if available.
- Repeat these steps for any other newly detected devices.

#### Which Jacks Trigger Auto Sensing?

TV Jacks and Auto Sensing	Auto Input Sensing	Auto Output Sensing	No Auto Sensing
<b>Y/VIDEO</b> (detected as composite video)	✓		
<b>Y/VIDEO plus Pb</b> (detected as component video)	✓		
<b>HDMI *</b>	✓		
<b>USB</b> (837 series)	✓		
<b>DIGITAL AUDIO OUTPUT</b> (orange jack)		✓	
<b>AVR AUDIO OUTPUT</b> (red jack)		✓	
<b>ANT</b> (Antenna)			✓
<b>IR NetCommand Output</b> (837 series)		✓	

\* The TV cannot detect an HDMI device when the device is powered off. Detection will occur when the device is next powered on.

#### When You First Connect a Device

- Most Device Types.** Select the device type from the on-screen list. The device type you select here will appear as a device icon in the **Activity** menu.
- A/V Receiver**
  - The TV can detect audio connections on the **DIGITAL AUDIO OUTPUT** jack and the right (red) **AVR AUDIO OUTPUT** jack.

- For an HDMI A/V receiver, select **AVR** from the list of device types if the A/V receiver is not recognized automatically.

- HDMI CEC Devices Compatible with the TV's HDMI Control Feature.** Compatible CEC-enabled HDMI devices are often recognized automatically by the TV. HDMI Control may allow you to control some functions of a CEC-enabled device. See Appendix C, "HDMI Control of CEC Devices."

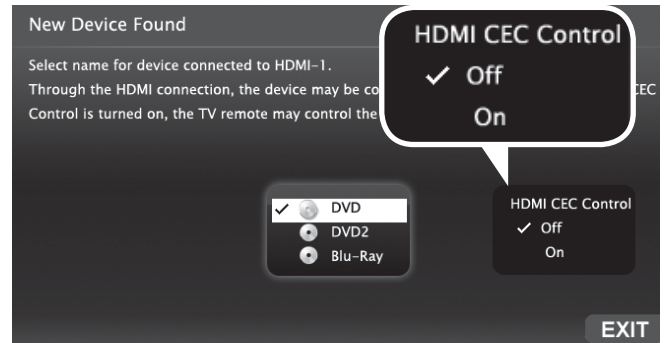

*New Device Found* screen for a device with HDMI control enabled. Select **On** to enable the TV's CEC control of the device. In some cases, as in the example above, you will also be prompted to select a device name.

#### Tips on Auto Sensing

- Choose a different name for each input.
- The antenna input (**ANT**) is never detected, although you can turn off the unused antenna input in the **Inputs > Name** menu.
- Change the device type displayed in the **Activity** menu by using the **Inputs > Name** menu (page 40).
- 837 series.** Any "learned" NetCommand IR codes will be erased if you change the device type in the **Inputs > Name** menu.

#### Reactivating Auto Input Sensing for an HDMI Input

When you disconnect an HDMI device, Auto Input Sensing is disabled until you perform these steps.

- Disconnect the HDMI device.
- Delete the removed HDMI device in the **Inputs > Name** menu (see "Removing an HDMI Device," page 68).
- Connect the new device and the **New Device Found** screen will display.

## Basic TV Operation

### Selecting an Input to Watch

1. Press **ACTIVITY**.
2. Press **▼▲** and **▶** to highlight an input.
3. Press **ENTER** to switch to the input.

### Watching Broadcast TV

#### TV Connected to an Antenna, Direct Cable, Cable Box, Set-Top Box, or Satellite Receiver

1. Select an input to watch from the **Activity** menu's **Watch TV** group.

**Note:** For more about the **Activity** menu, see page 21.

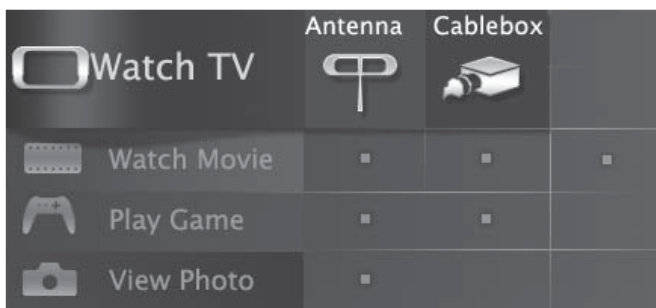

Activity menu, antenna input selected

2. Tune to a channel.
  - Enter the channel number using the number keys on the remote control and press **ENTER**. For a two-part digital channel, such as 3-1, press **3** **CANCEL** **1** to enter a dash (separator).
  - Press **CHANNEL UP/CHANNEL DN** to change channels one channel at a time.
  - Press **↶ (LAST)** to switch back to the previously tuned channel.
  - **Antenna or Direct Cable Only.** Press **GUIDE** to display ChannelView channel listings, highlight a channel number, and press **ENTER** to tune.

### Watching DVDs or Videos

#### TV Connected to a DVD Player, DVR, or VCR

Press **ACTIVITY** and select a movie source from the **Activity** menu. If you named devices during Auto Input Sensing, select the input from the **Watch Movie** group.



Activity menu, DVD input selected

### TV Tips

#### Turning the TV On or Off

- Point the remote control at the front of the TV and press the **POWER** button.
- Press the **POWER** button on the TV control panel.

#### If You Turn Off the TV by Mistake

- Press **POWER** again, within about 60 seconds, to have the TV come back on immediately.
- If the status indicator starts rapidly blinking green (about 60 seconds after you shut off power), wait a few moments for the status indicator to stop blinking and press **POWER** to turn the TV on again.

#### Controlling Sound Volume

- Press **VOLUME UP/VOLUME DN** to adjust the sound level.
- See also “Controlling A/V Receiver Sound Volume” on page 22.

## Basic TV Operation, continued

### Making Picture Adjustments

- To get the best picture under different viewing conditions, set the Picture Mode before changing other video settings. See page 35 for more.
  - Press **MENU** and go to the **Adjust > Picture > Picture Mode** menu.
  - Make one of these selections:
 

Name	When to Use
<b>Brilliant</b>	Under bright light
<b>Game</b>	With gaming consoles
<b>Bright</b>	For most daytime viewing
<b>Natural</b>	For most nighttime viewing
  - Press **MENU** to clear the menu.
- Press **MORE**.
- Press **8 (VIDEO)**.
- Press **▼ ▲** to display the name of the adjustment you want.
- Press **◀ ▶** to make the adjustment.

Additional picture adjustments are described on pages 34 and 35.

### Audio Settings

#### Changing the Audio Output

To switch audio output from the internal TV speakers to a connected external sound system or headphones:

- Press **MORE**.
- Press **9 (AUDIO)**.
- Press **▼ ▲** until the **Speakers** option is displayed. The **Speakers** option will display only if a connection has been detected on one of the TV's audio outputs.
- Press **▶** to switch between **TV** and either **AV Receiver** or **Headphones**.

#### Changing Audio Settings

- Press **MORE**.
- Press **9 (AUDIO)**.
- Press **▼ ▲** to display the name of the adjustment you want.
- Press **◀ ▶** to change the setting.

### Other TV Features

- Activate Audio Lock to control your sound system with the TV's remote control left in **TV** mode. See page 60.
- To set the TV Clock see page 38. Set the TV Clock if you plan to use the TV Timer (page 38) or ChannelView (page 22) features.
- To set parental controls, see the **Lock** menu, page 42.
- To change the input names that appear in the **Activity** menu, see **Inputs > Name** options, page 40.
- 3D Video**. See page 25.
- To program the remote control to operate other A/V devices, see Appendix B, "Programming the Remote Control," page 59.
- To control compatible devices using HDMI CEC control, see Appendix C, "HDMI Control of CEC Devices," page 66.
- 837 Series**. To view still and moving digital camera images on the TV, see "Camera Images and Music Files," page 28.
- 837 Series**. To control A/V devices with NetCommand, see chapter 5, "NetCommand IR Control for Most Devices" on (page 45).

### Other Information

#### TV Care

- Lamp Cartridge**. When the lamp cartridge needs replacement, **replace the lamp yourself and save the cost of a service call**. See Appendix D for instructions.
- General Cleaning**. See "Cleaning Recommendations," page 71.

#### Assistance

- For troubleshooting, service, and product support, see Appendix E, page 72.
- For warranty information, see the TV warranty on page 81.

# 2

## TV Connections

---

### ***Before You Begin***

#### ***Auto Input Sensing***

The TV's Auto Input Sensing feature automatically recognizes most connections and prompts you to identify the type of device connected. See page 11 for more on Auto Input Sensing.

#### ***Connection Types***

Use the connection types available on your input devices that will give the best video quality. For example, choose HDMI over component video, and choose component video over composite video.

#### ***Picture Quality***

For best picture quality, route signals directly from the input device to the TV whenever possible.

#### ***Surround Sound***

For best surround sound audio quality, route audio-signal cables or HDMI cables from the source device directly to your A/V receiver or sound system.

#### ***IMPORTANT***

**Accessory items such as cables, adapters, splitters, or combiners required for TV connections are not supplied with the TV. These items are available at most electronics stores.**

## Inputs and Outputs

### Main Connection Panel

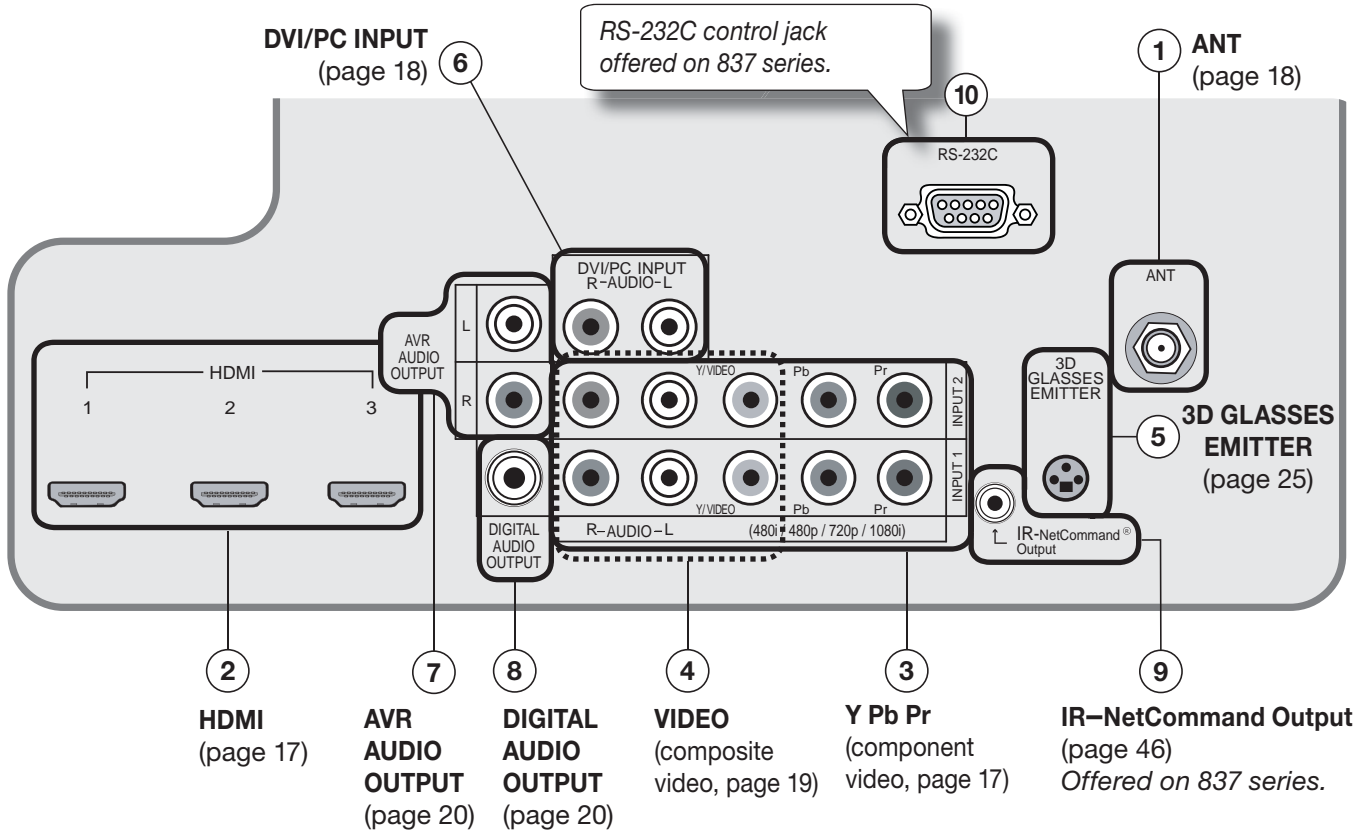

### Convenience Inputs

A readily accessible set of jacks is provided for a camcorder, game, or other audio/video device.

**837 Series.** A fourth HDMI input is provided. If you connect a DVI device to the HDMI input, use the nearby audio jacks to send sound from the device to the TV.

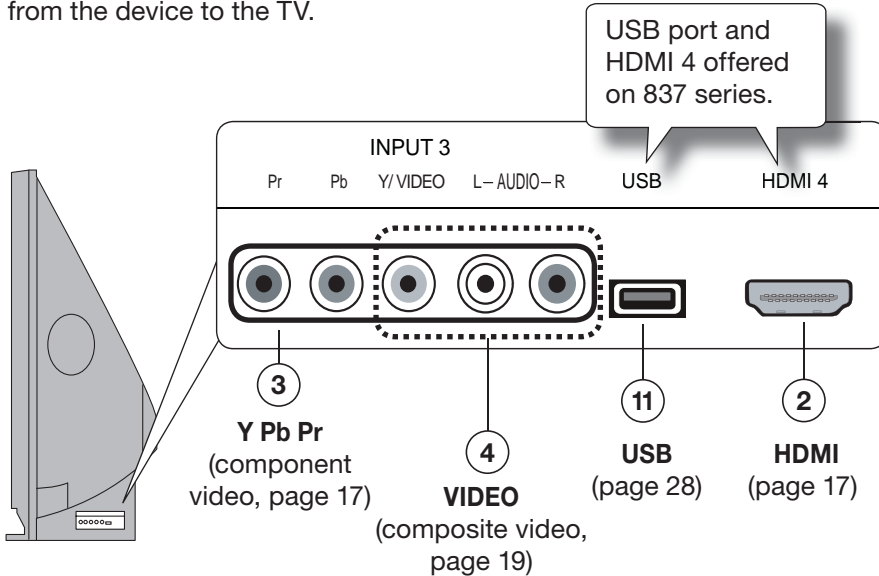

### Using an Audio-Only Device

Keep an unused RCA-style connector in the Y/VIDEO jack while using an audio-only device.

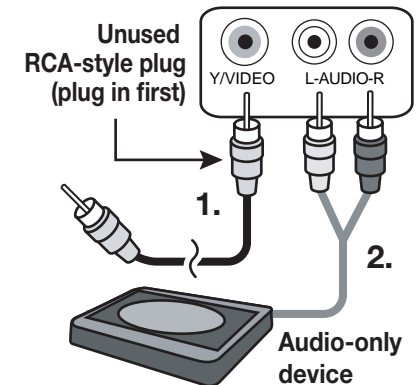

## Inputs and Outputs, continued

### 1. ANT (Antenna)

Connect your main antenna or direct cable service (no cable box) to **ANT**. The **ANT** input can receive digital and analog over-the-air channels from a VHF/UHF antenna or non-scrambled digital/analog cable source.

### 2. HDMI™ Inputs (High-Definition Multimedia Interface)

The HDMI inputs support uncompressed standard and high-definition digital video formats and PCM digital stereo audio.

**Mitsubishi recommends you use category 2 HDMI cables**, also called high-speed HDMI cables, to connect HDMI 1.3 source devices. High-speed category 2 cables bring you the full benefits of Deep Color and **x.v.Color**.

These HDMI inputs can also accept digital DVI video signals. To connect a device's DVI output to the TV's HDMI input, use an HDMI-to-DVI adapter or cable plus analog audio cables. Connect the analog audio cables to the **DVI/PC INPUT AUDIO** jacks on the TV to receive left and right stereo audio from your DVI device.

Use the HDMI inputs to connect to CEA-861 HDMI compliant devices such as a high-definition receiver or DVD player. These inputs support 480i, 480p, 720p, 1080i, and 1080p video formats.

The TV's HDMI inputs are compatible with many DVI-D and HDMI computer video signals.

These inputs are HDCP (High-Bandwidth Digital Copy Protection) compliant.

#### HDMI Cable Categories

HDMI cables are available as Category 1 and Category 2 types.

- **Category 2 Cables** (also called high-speed HDMI cables). Newer, HDMI 1.3-compliant DVD players, video games, and set-top boxes require Category 2 cables, suitable for clock frequencies up to 340 MHz or data rates of up to 10.2 gigabits per second. Use category 2 cables for high-speed 1080p HD signals carrying extended color encodings (i.e., 30 or more bits, also called Deep Color). Category 2 cables are also suitable for standard HDTV signals.
- **Category 1 Cables** (also called standard HDMI cables). Category 1 cables may be unmarked. They are suitable for standard HDTV 720p, 1080i, and 1080p signals with 8-bit color depth. Use category 1 cables for clock frequencies up to 74.25 MHz or data rates of up to 2.23 gigabits per second.

### 3. Y Pb Pr (Component Video)

Connect devices with component video outputs to this jack. Use the adjacent **AUDIO R** and **L** jacks if you wish to send audio to the TV.

### 4. VIDEO (Composite Video)

Connect a VCR, DVD player, standard satellite receiver, or other A/V device to the TV. Use the adjacent **AUDIO R** and **L** inputs if you wish to send audio to the TV.

### 5. 3D GLASSES EMITTER

Use this jack for the special IR emitter supplied with 3D glasses. The emitter will send a signal that synchronizes your 3D glasses with the screen display. See page 25

### 6. DVI/PC INPUT AUDIO

When connecting a DVI device to one of the TV's HDMI inputs, use these jacks for left and right analog audio.

### 7. AVR AUDIO OUTPUT

Use **AVR AUDIO OUTPUT** to send analog audio of the current program to an analog A/V surround sound receiver or stereo system. Digital audio from digital channels and HDMI devices is converted to analog audio by the TV for output on this jack. This is the only audio connection needed to the TV if using an analog A/V receiver or stereo system.

**Headphones.** The audio right (red) jack can also be used for headphones that accept standard line level audio signals.

### 8. DIGITAL AUDIO OUTPUT

This output sends Dolby Digital or PCM digital audio to your digital A/V surround sound receiver. Incoming analog audio is converted by the TV to PCM digital audio. If you have a digital A/V receiver, in most cases this is the only audio connection needed between the TV and your A/V receiver.

### 9. IR-NetCommand Output

**837 Series.** Connect IR emitters to this jack to send control signals to external IR remote-controlled devices.

### 10. RS-232C

**837 Series.** Use the RS-232C interface to receive control signals from compatible home-theater control devices. See [www.mitsubishi-tv.com](http://www.mitsubishi-tv.com) for a list of control signals for this interface.

### 11. USB (837 Series)

The TV can read JPEG photo files and mp3 or wma music files from a USB device connected to the USB port.



## Y Pb Pr Component Video Device

### HDTV Cable Box, Satellite Receiver, DVD/Blu-ray Player

If your cable box or satellite receiver has an HDMI output, use the connections for HDMI devices described on this page.

Required:

- RCA-type component video cables
- Left/right analog audio cables.

**Note:** To hear digital surround sound, connect the digital audio output from the device directly to your digital A/V receiver.

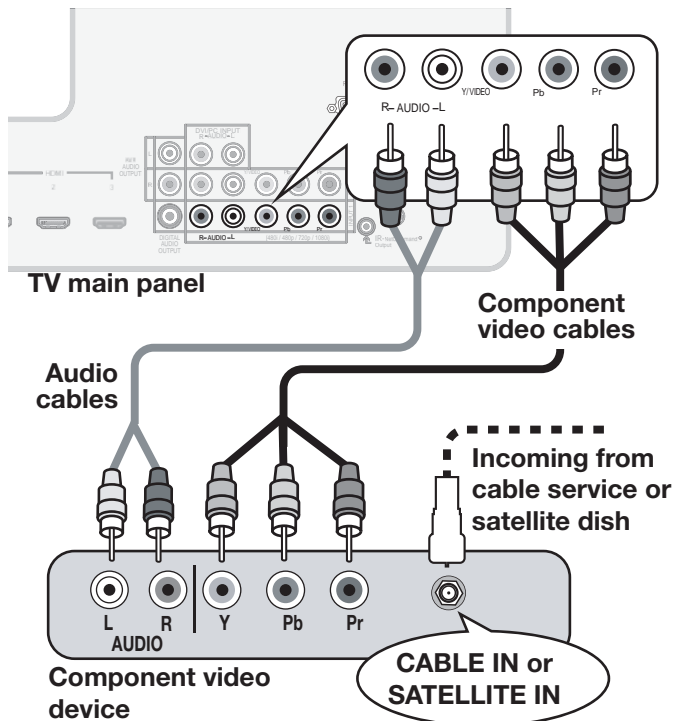

## HDMI Device

### HDTV Cable Box, Satellite Receiver, DVD/Blu-ray Player

Required: HDMI-to-HDMI cable.

Connect an HDMI cable from the TV back panel to the HDMI device output. HDMI devices provide video and audio through the single cable.

Mitsubishi recommends you use category 2 (high-speed) HDMI cables to connect HDMI 1.3 source devices. High-speed category 2 cables bring you the full benefits of Deep Color and **x.v.Color**. See "HDMI Cable Categories" on the opposite page for more on HDMI cable types.

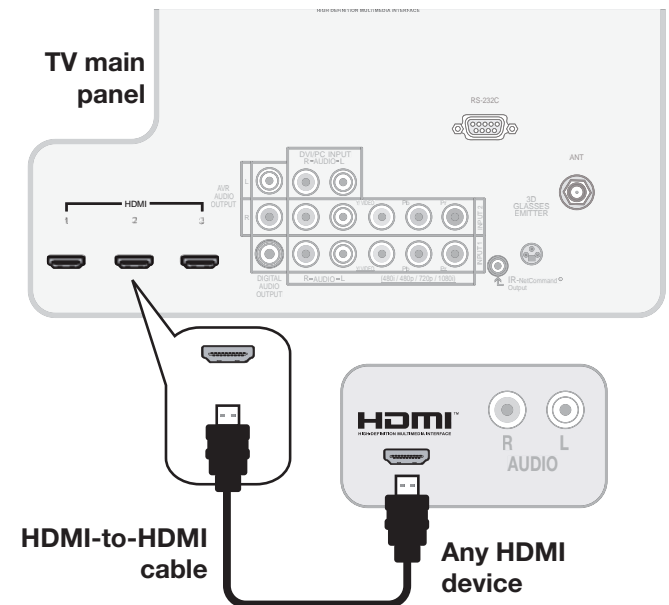

### IMPORTANT

#### HDMI and Audio Signals

Digital Surround Sound: The TV's HDMI inputs can receive digital stereo audio signals only. To hear digital surround sound from an HDMI device, connect the device's HDMI or digital audio output directly to your A/V receiver. See the Owner's Guides for those devices for instructions.

### DVI Video Device

#### Cable Box, Satellite Receiver, DVD Player

Connect DVI devices (digital only) to the TV's HDMI input jacks.

Required:

- Analog stereo audio cables
- DVI-to-HDMI cable or DVI/HDMI adapter and HDMI cable

If you are using a DVI/HDMI adapter, it is important to connect the adapter to the DVI device for best performance.

Some devices require connection to an analog input first in order to view on-screen menus and to select DVI as the output. Please review your equipment instructions for DVI connectivity and compatibility.

**Note:** The HDMI connection supports copy protection (HDCP).

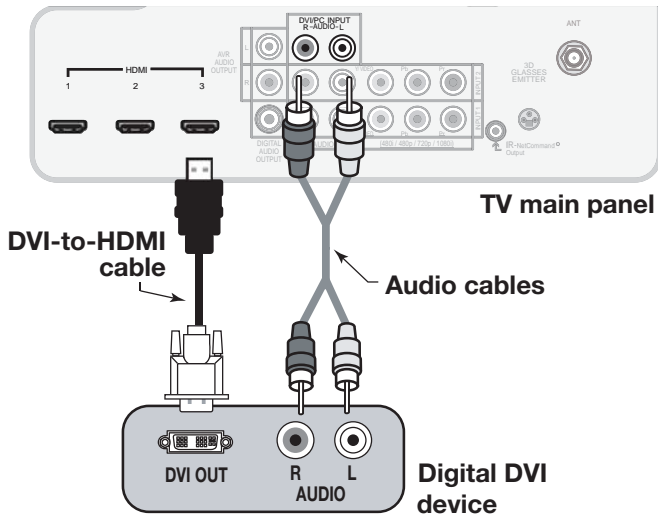

### Antenna or Cable TV Service

Connect the incoming cable to the TV's ANT input.

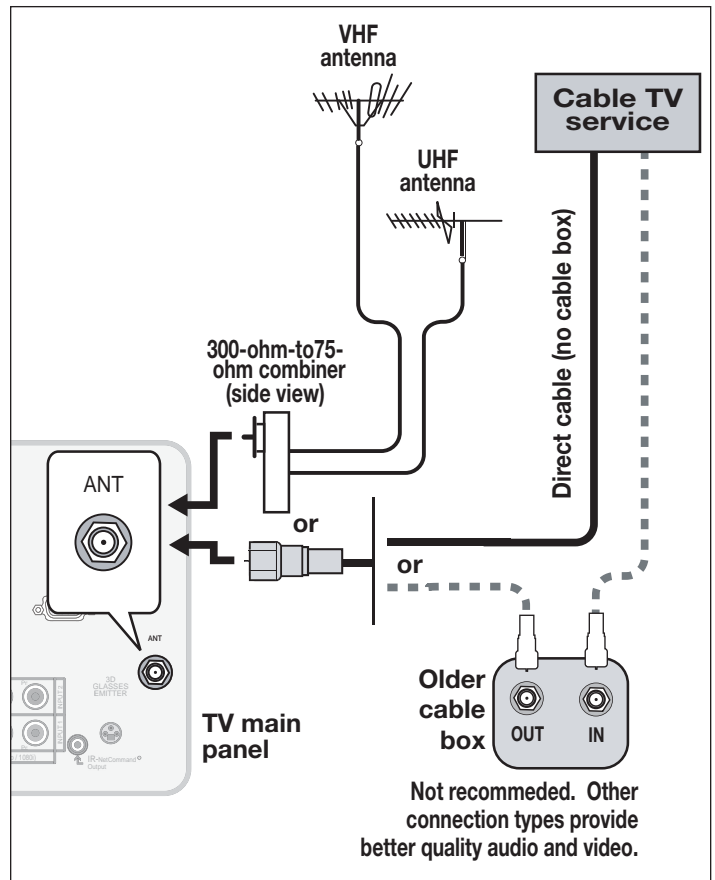

### Composite Video Device

#### VCR or other device with composite video output

Required:

- Composite video cable (usually yellow)
- Analog stereo audio cables.

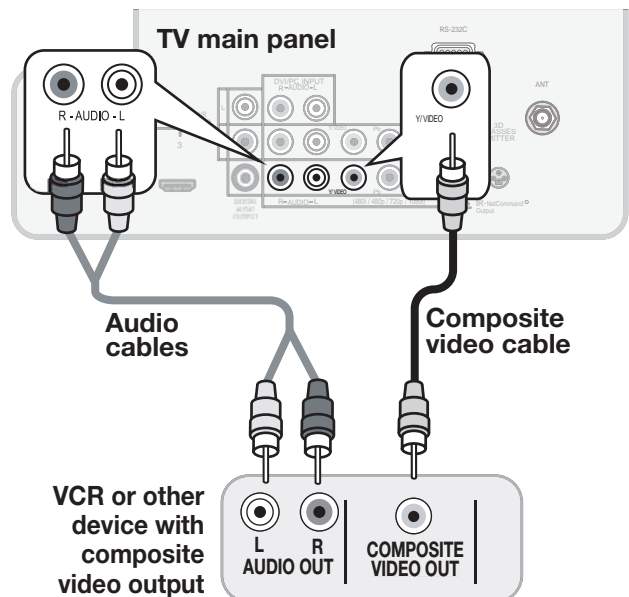

### VCR or DVD Recorder to an Antenna or Wall Outlet Cable

**Required:**

- Two-way RF splitter
- Two coaxial cables
- Right and left analog audio cables
- Component or composite video cables

**Note:**

- Use composite video only if component video or HDMI are unavailable. For an HDMI connection between the TV and recorder, see page 17.
- If your recording device has an analog-only tuner, you must use a digital converter box to enable recording of digital broadcasts.

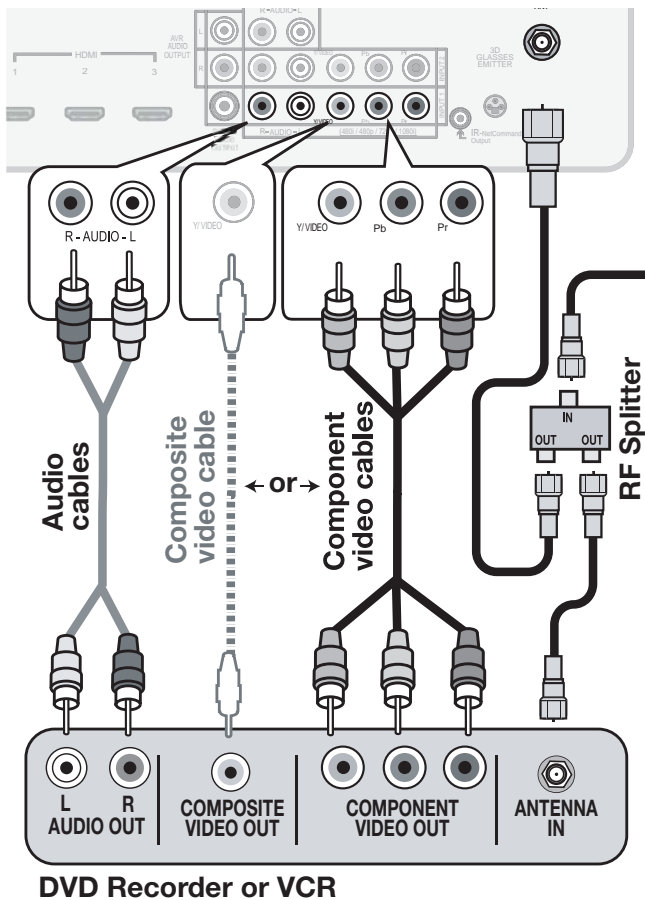

### VCR or DVD Recorder to a Cable Box

**Required:**

- Two-way RF splitter
- Three coaxial cables
- Right and left audio cables
- Composite or component video cables
- Video and audio cables required to connect the TV to the cable box.

**Notes:** Use composite video if only if component video or HDMI are unavailable. For an HDMI connection between the TV and recorder, see page 17.

When using this connection configuration, it is possible to view live cable programs through the recording device. For best picture quality always view live cable programs directly from the TV input connected to the cable box device.

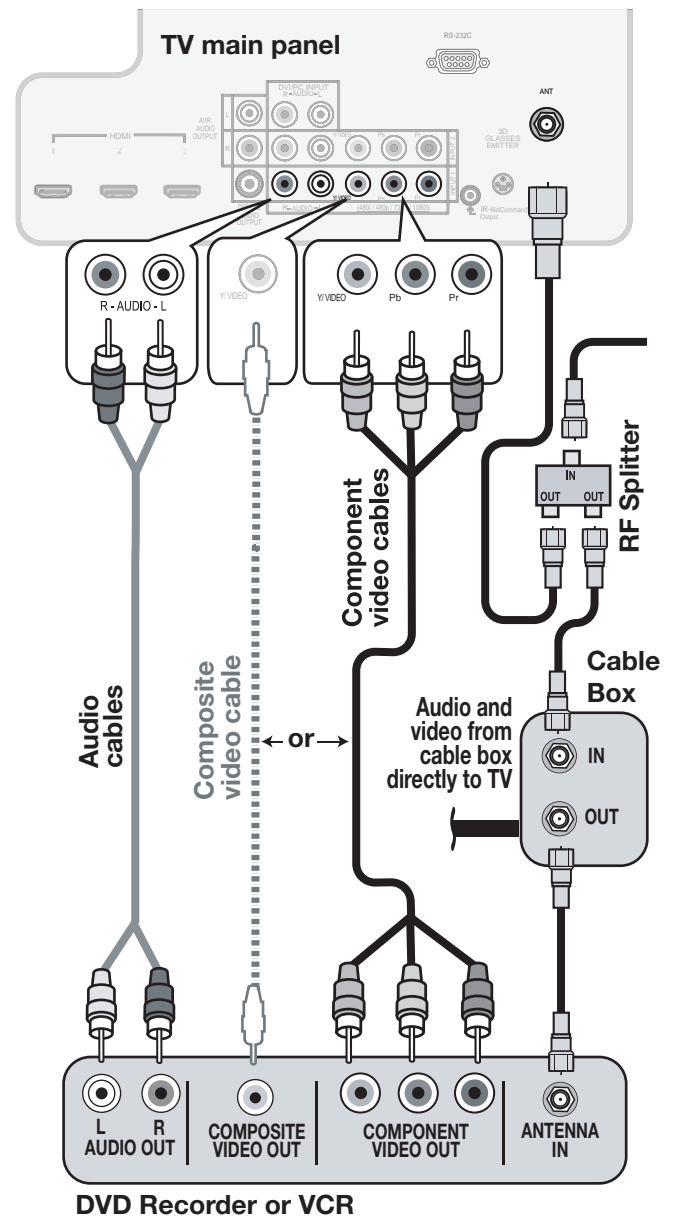

## A/V Receiver

Most setups require either a digital audio cable or analog stereo audio cables. To send audio from TV channels received on the **ANT** input or devices connected directly to the TV, you must use one of the connections shown below. Usually, only one of these connections is required.

The TV makes all audio available in digital and analog formats:

- Analog audio coming into the TV is available as output in digital stereo format on the **DIGITAL AUDIO OUTPUT** jack.
- Digital incoming audio is available as analog output on the **AVR AUDIO OUTPUT L** and **R** jacks.

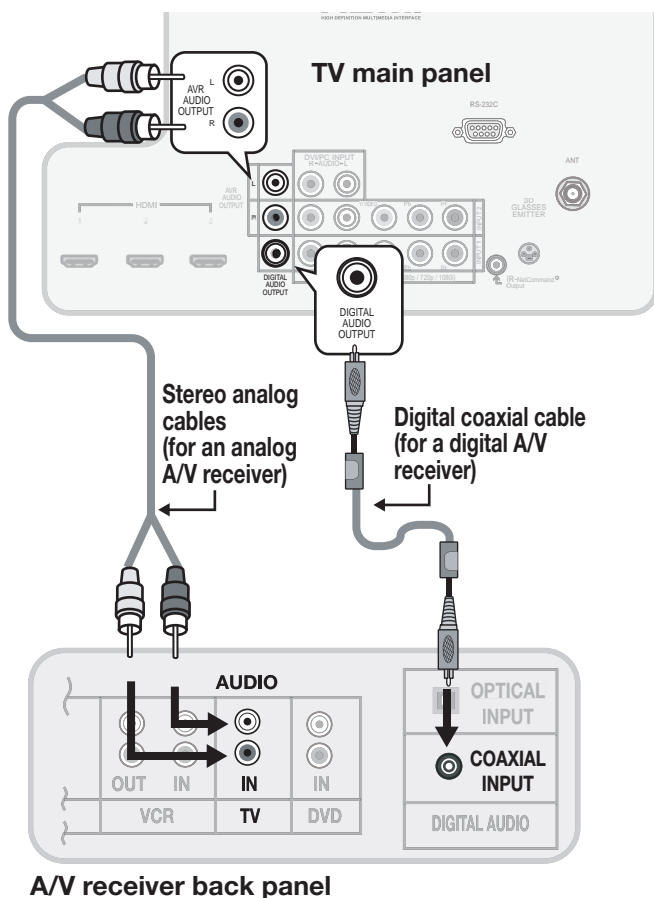

### Note:

- On rare occasions, an HDMI signal may be copy-restricted and cannot be output from the TV as a digital signal. To hear these copy-protected signals through the A/V receiver, use the connection for an analog A/V receiver.
- Check the A/V receiver's Owner's Guide for information concerning use of the digital input and switching between digital sound and analog stereo sound from the TV.

## A/V Receiver with HDMI Output

Required: One HDMI-to-HDMI cable

This option allows you to view content from devices connected to an A/V receiver. The A/V receiver can send audio and video to the TV over a single HDMI cable. You can use an HDMI connection as described here in addition to an audio connection from the TV's audio output. The optional audio connection allows you to hear, through the A/V receiver, devices connected to the TV only, e.g., an antenna on the **ANT** input.

You may be able to use the TV's remote control (in **TV mode**) to operate connected CEC-enabled HDMI devices. Experiment with your equipment to determine which functions are available to the TV's remote control. See Appendix C, page 66.

**837 Series:** This setup allows you to use NetCommand-controlled audio and video switching over the HDMI cable. See "Case 3: Automatic Audio and Video Switching via HDMI" on page 54.

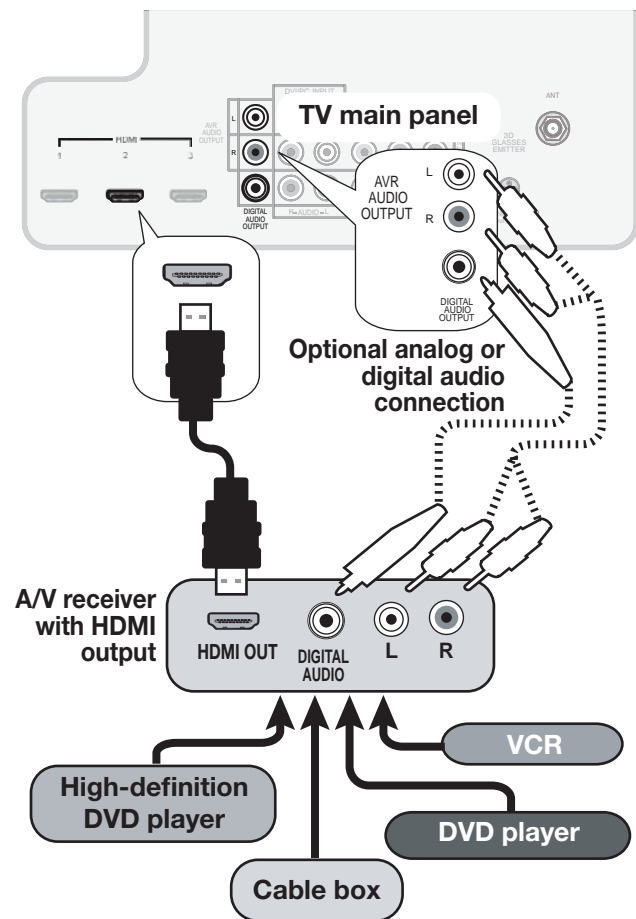

# 3 Using TV Features

## Selecting an Input

The **Activity** menu lets you switch TV inputs. The inputs are organized into groups based on possible ways to use them.

1. Press the **ACTIVITY** key.
  2. Use **▲▼** to move through groups of TV inputs.
  3. Use **◀▶** to select an input.
  4. Press **ENTER** to switch to the input.
- To change the list of inputs shown in each activity group, see **Inputs > Activity**, page 40.
  - To assign or change the names of input icons, use the **Inputs > Name** menu, page 40.



## Sleep Timer

The Sleep Timer turns the TV off after the length of time you set.

To set the TV to turn on at a certain time of day, see the **Initial > Timer** menu on page 38.

### Setting the Sleep Timer

1. Press **MORE** on the remote control. The TV's **MORE** menu will display.
2. Press **CANCEL (SLEEP)** repeatedly to increase the time in 30-minute increments. The maximum is 120 minutes.
3. Press **BACK** or wait five seconds without pressing any keys for the message to disappear.

### Viewing or Changing the Sleep Timer

1. Press **MORE**.
2. Press **CANCEL (SLEEP)**.
3. Press **CANCEL (SLEEP)** additional times to change the number of minutes before the TV powers off.

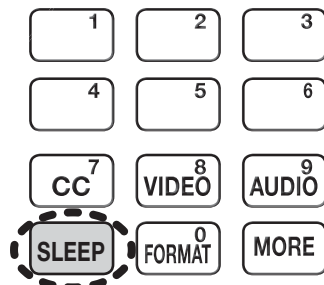

With the **MORE** menu displayed, press the **CANCEL** key on the remote control to activate/deactivate the Sleep feature.

## ChannelView Channel Listings

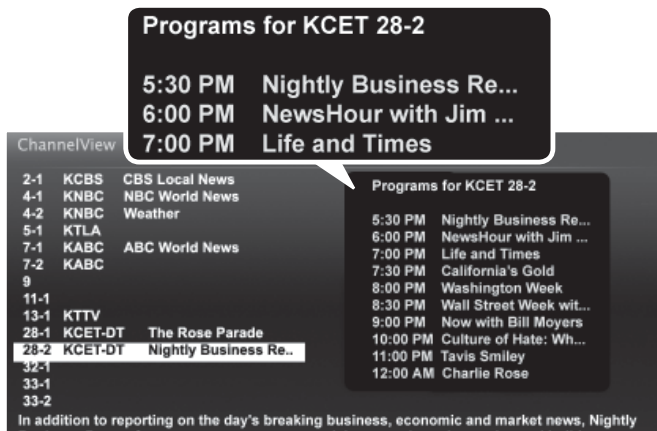

ChannelView. Programs for the tuned channel are listed on right side of screen.

ChannelView™ shows memorized channels on the **ANT** input. It displays channel names and program information for digital channels as sent by broadcasters or your local cable service provider (information may be incomplete). No program information is displayed for analog channels.

**Note:** You must set the TV Clock (page 38) to receive ChannelView listings for the current channel.

### Using ChannelView

Feature	Instructions
Receive updates for a digital channel.	<ol style="list-style-type: none"> <li>1. Tune to the channel.</li> <li>2. Press the <b>INFO</b> key.</li> </ol>
Display/hide ChannelView listings from the <b>ANT</b> input.	<b>GUIDE</b>
Scan channels one by one.	Hold <b>▲</b> or <b>▼</b>
Scan channels quickly.	Hold <b>PAGE UP/PAGE DN</b>
Jump to listings for a specific channel.	<ol style="list-style-type: none"> <li>1. Enter the channel number.</li> <li>2. Press <b>ENTER</b>.</li> </ol>
See more of the program description for the current channel (if available).	<b>INFO</b>
Tune to the highlighted channel.	<b>ENTER</b>

## Redirecting Audio Output

### Selecting an Audio Output Device

1. Press **MORE** and then **9 (AUDIO)**.
2. Press **▲** to show the **Speakers** option. The **Speakers** option will display only if there is a connection on a TV audio output.
3. Press **▶** to select either **AV Receiver**, **Headphones**, or **TV**.

### Disconnecting an Analog A/V Receiver

When you disconnect an analog A/V receiver, change the **Speakers** setting to **TV** to hear sound from the TV speakers. Change the setting using the remote control's **MORE > 9 (AUDIO)** key or the **Adjust > Audio > Speakers** menu.

## Controlling A/V Receiver Sound Volume

Use one of the methods below to control sound volume from an A/V receiver.

### With a Standard TV Setup

- **Recommended Method:** Program the TV's remote control for your A/V receiver and enable the Audio Lock feature. See page 60.
- Program the TV's remote control for your A/V receiver and set the TV remote control's mode to **AUDIO**. Return the control mode to **TV** to control the TV.
- Use the remote control that came with the A/V receiver.

### With HDMI Control (CEC-Enabled HDMI A/V Receiver)

The TV's remote control may control some functions of the A/V receiver. See Appendix C, "HDMI Control of CEC Devices," page 66.

### With NetCommand IR Control

**837 Series.** Set up NetCommand control of the A/V receiver's volume functions in the **Inputs > AVR** menu. The TV's remote will then control A/V receiver volume. See page 52.

## Status Display

Press the **INFO** key to see the on-screen status display. The most common displays are shown here.

Sample information from the on-screen status display

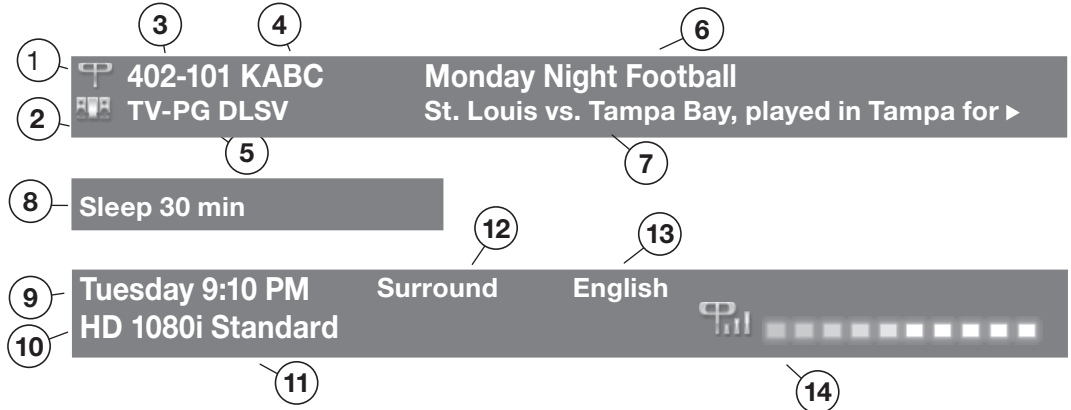

### About Channel Numbers

#### Channel Numbers for Over-the-Air Reception or Reception by Direct Cable

**Note:** All signals are automatically converted to 1080p for display.

#### Standard-Definition Analog Channels



Receiving Standard-Definition Analog Signal (480i)

#### Standard-Definition Digital Channels



Receiving Standard-Definition Digital Signal (SD)

#### High-Definition Digital Channels



Receiving High-Definition Digital Signal (HD)

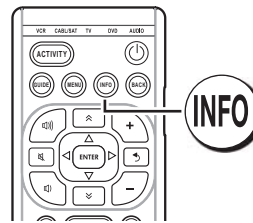

1. Current Input

---

2. Audio Indicator. Key:
  - TV speakers
  - External sound system
  - Headphones
  - Mute

---

3. Channel number (antenna source only)  
Digital channel includes major and sub-channel numbers.

---

4. Digital channel name (if broadcast); antenna source only.

---

5. V-Chip rating
  - Antenna source only for digital signal
  - Antenna or **VIDEO** composite jack for analog signal

---

6. Program name (if broadcast); digital source only

---

7. Program description (if broadcast); digital source, antenna only. Press the **INFO** key additional times to see more of the description.

---

8. Sleep Timer remaining time

---

9. Day and time

---

10. Signal type being received

---

11. Screen format in use

---

12. **Program Audio** indicator (antenna source only)
  - Digital source: Stereo, Surround, Dual Mono
  - Analog source: Stereo, Stereo SAP, SAP

---

13. Available language (digital source, antenna only)

---

14. Signal-strength indicator (digital source, antenna only)

## TV Signals and Display Formats

This is a 16:9 widescreen TV suitable for images available from HDTV and many DVDs. You can view older-style, squarish images (4:3 aspect ratio) using one of the display formats described on this page. Press the **MORE** key and then the **0** key (**FORMAT**) to cycle through available display formats. The TV remembers the format you last used for each input.

### DVD Image Definitions

Image information may be stated on the DVD case. Some DVDs support both of the formats described below.

#### Anamorphic (or Enhanced for WideScreen TV)

Indicates DVDs recorded to show widescreen images properly on 16:9 TV sets using the TV's Standard format mode (recommended).

#### Non-Anamorphic (or 4:3, 1.33:1, Letter Box, or Full Screen)

Indicates DVDs recorded for viewing on squarish TV screens. They may be full screen (4:3 or 1.33:1) which crops movies to fit the narrow TV, or letter box, which adds black top and bottom bars.

### Signal Definitions

**480i:** Older type of interlaced signals from the **ANT** input, composite **VIDEO**, component **Y Pb Pr**, or **HDMI** jacks.

**480p:** Progressive-scan DVD signals on component **Y Pb Pr** or **HDMI** jacks.

**720p and 1080i:** High-definition signals received through component **Y Pb Pr** or **HDMI** jacks. These signals are always 16:9 (widescreen).

**1080p:** High-definition signals from a PC or Blu-ray player, **HDMI** inputs only.

**SD 4:3:** Standard-definition squarish-screen-format signals from digital channels on the **ANT** input.

**SD 16:9:** Standard-definition widescreen-format signals from digital channels on the **ANT** input.

**HD 16:9:** High-definition 16:9 widescreen signals from digital channels on the **ANT** input.









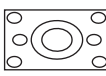
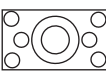

### TV Display Format Definitions

**Standard:** The full-screen format used by HDTV signals. Use this format to display anamorphic DVDs with a 1.78:1 or 1.85:1 aspect ratio. Anamorphic DVDs with a 2.35:1 aspect ratio are displayed correctly but with top and bottom black bars. Squarish (4:3) images are stretched evenly from side to side. Available for all signals.

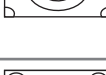
**Expand:** Enlarges the picture to fill the screen by cropping the top and bottom; useful for reducing the letter box top and bottom bars of non-anamorphic DVD images.

**Zoom:** Enlarges the picture to fill the screen by cropping the sides, top, and bottom to eliminate black bars.

- **480i/480p and SD 4:3 signals:** Eliminates top and bottom bars on anamorphic DVDs with a 2.35:1 aspect ratio.
- **720p, 1080i, SD 16:9, and HD signals:** Eliminates bars added to squarish 4:3 images.

Original Signal TV Display	Original Signal	
	Non-anamorphic or SD 4:3	Anamorphic DVD
<b>Standard</b>	 Distorted. Not recommended.	 Recommended
<b>Expand</b>	 Recommended for letterbox. See Note 1.	 Distorted; not recommended. See Note 1.
<b>Zoom</b>	 Distorted. Not recommended. See Note 1.	 Recommended for anamorphic 2.35:1 images. See Note 1.
<b>Stretch</b>	 Recommended for standard broadcasts. See Note 1.	 Distorted; not recommended. See Note 1.
<b>Stretch Plus</b>	 Recommended for standard broadcasts. See Note 1.	 Distorted; not recommended. See Note 1.
<b>Narrow</b>	 See Note 1	 Distorted; not recommended. See Note 1.

**Note 1:** Available for 480i, 480p, and digital SD 4:3 signals only.

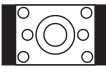
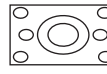
Original Signal	Display Formats	
<b>SD 16:9 or HD Digital 720p, 1080i, 1080p Signal</b>	 <b>Wide Expand</b>	Recommended to remove side bars.
	 <b>Zoom</b>	Recommended to remove bars from the top, bottom, and sides.

**TV Display Formats.** Press the **MORE** key and then repeatedly press the **0** key (**FORMAT**) to see the displays available for the current program. Press the **INFO** key to see the name of the display format in use.

**Stretch:** Stretches a squarish 4:3 image across the screen to display the entire image with less distortion than the Standard format.

**Stretch Plus:** Similar to Stretch, but minimizes distortion on the sides by expanding the picture to crop off portions of the top and bottom. Use **▲▼** to adjust the vertical position of the picture.

**Narrow:** Displays narrow 4:3 images in their original shape. Adds black side bars to fill the screen.

**Wide Expand:** Enlarges the picture, cropping the image on both sides. Removes or reduces black side bars added to narrow images converted to 16:9 signals for digital broadcast.

**Note:** All high-definition channels send widescreen (16:9) signals, but not all programming was created for the widescreen format. The broadcaster may stretch the image or add side bars to fill the widescreen area.



## 3D Video

This section provides Instructions for viewing 3D video using 3D glasses and the TV's 3D feature. The 3D options are found in the **Adjust > 3D Mode** menu described on page 34.

### Initial Setup

1. Check if your HDMI 3D video source device outputs a 1080p 60 Hz signal. This information will be needed when you assign an input name in the **New Device Found** screen.
2. If your 3D glasses came with an emitter box, connect the emitter box to the **3D GLASSES EMITTER** jack. Place the box in front of the TV where there is an unobstructed path to the glasses.

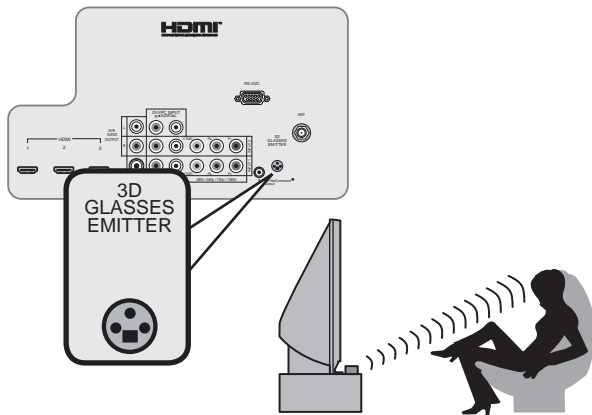

3. Power on the TV and the source device.
4. Connect the source device to the TV's HDMI input.
5. When the **New Device Found** screen displays, name the input according to the table below. The signal type and choice of name are important because the TV will process the video signal differently depending on the name you assign. If your source device is a Blu-ray disc or game console, the signal must be 1080p at 60 Hz.

Source of 3D Video	3D Video Signal	Assign Name
Computer	Recommended: 1080p 60 Hz (1920 X 1080). The image will fill the TV screen. Other 60-Hz computer video signals compatible with the TV will display with black bars. See "Computer Display Formats" on page 27.	<b>PC</b>
Any other 3D video source	To see 3D video, the signal must be 1080p 60 Hz	Any other name

6. Press **BACK** to close the **New Device Found** screen.

### Watching 3D Video

**Note:** 3D glasses are required.

1. Press **ACTIVITY**.
2. Highlight the icon for the 3D video device and press **ENTER**.
3. Press **MENU** and select the **Adjust > 3D Mode** menu.
4. Select **On**. The **On** setting will be memorized for the current input when you exit this menu.

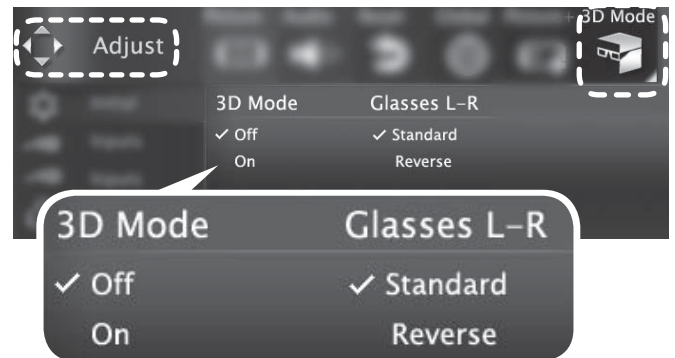

Use the **Adjust > 3D Mode** menu to enable 3D video.

5. Press **BACK** to close the menu.
6. If the image does not appear correct (e.g., objects appear to be moving in instead of out), open the **Adjust > 3D Mode** menu and set **Glasses L-R** to **Reverse**.

### To Watch Regular (non-3D) Video

The **3D Mode** setting is memorized for each input. When you want to watch non-3D video on the input selected above, open the **Adjust > 3D Mode** menu and set **3D Mode** to **Off**.

#### Important Note About 3D Images

To display 3D images, Mitsubishi Home Theater DLP TVs require that source devices support checkerboard display formats for 3D gaming or 3D cinema content. A 3D standard format does not currently exist for Blu-ray or DVD prepackaged media. Future 3D standards may be incompatible with Mitsubishi Home Theater DLP TVs. Please visit [mitsubishi-tv.com](http://mitsubishi-tv.com) for updates and information.

## Using the TV with a Personal Computer

### Connecting a Computer to the TV

Use one of the connection methods listed below based on your computer's video output.

Computer Video Output	Video Connection	Audio Connection
<b>Digital DVI</b>	DVI-to-HDMI cable or an HDMI cable with an HDMI-to-DVI adapter	Stereo audio cables
	<b>Note:</b> If the computer's audio output is a single mini jack, a mini audio-to-RCA-male "Y" adapter cable is also required.	
<b>HDMI</b>	HDMI-to-HDMI cable	No additional audio connection is required.

#### IMPORTANT

This TV accepts digital computer signals only.

1. Connect the computer's digital signal output to one of the TV's **HDMI** jacks. See the connection diagrams for the method suited to your equipment.
2. Connect the computer's audio output using one of these options:
  - For digital DVI signals, connect analog left/right audio to the TV's **DVI/PC INPUT AUDIO** jacks.
  - For HDMI signals, no additional audio connection is required.
3. Power on the TV and computer. The TV will detect the connection and display the **New Device Found** screen.
4. In the **New Device Found** screen, press **▲▼** to highlight **PC** in the list of device types. It is important to use the name **PC** so that the TV processes the video signal correctly.
5. Press **BACK** to close the **New Device Found** screen.

**Note:** If your computer provides digital audio output (coaxial or optical), you can connect it directly to a digital A/V receiver and bypass the TV.

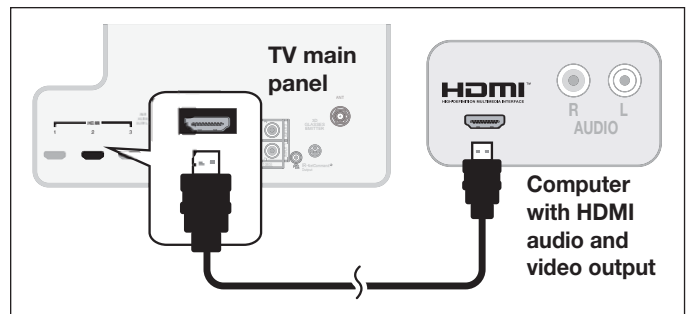

An HDMI-to-HDMI connection carries all video and audio on a single cable.

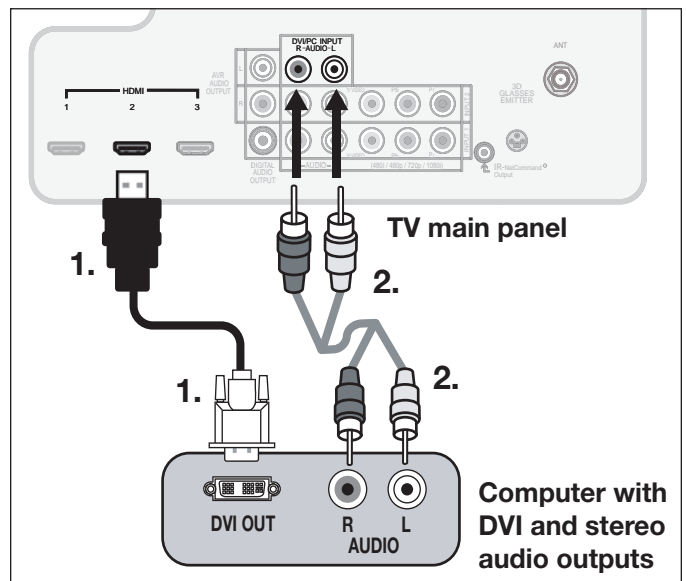

A DVI connection from a personal computer requires a separate audio connection. A computer connected to the TV main connector panel is shown above.

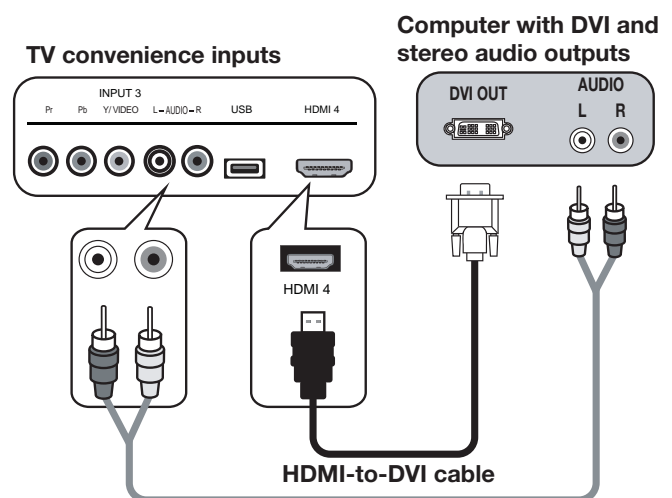

**837 Series:** Computer with DVI output connected to the convenience panel.

## Using the TV with a Personal Computer

### Computer Video Adjustments

1. Power on the computer.
2. Select **PC** from the **Activity** menu. To do this, press **ACTIVITY** to open the **Activity** menu, move the highlight to the PC icon, and press **ENTER**.
3. Working from the computer, change the resolution of the computer image. View the computer image on the TV and maximize the computer resolution while maintaining a suitable aspect ratio for the image.
4. Perform TV video adjustments. Press **MORE** then press **8 (VIDEO)** repeatedly to access video-adjustment options. The following additional adjustments are available for computer video:
  - Horiz Position** (Horizontal Position). Manually adjust the horizontal position.
  - Vert Position** (Vertical Position). Manually adjust the vertical position.
5. Press **MORE** then press **0 (FORMAT)** repeatedly to find the picture format (aspect ratio) best suited to the image. See the chart on this page showing how different computer resolutions can be displayed on the TV.

#### Distortion in Computer Images

Computer images may show distortion when viewed on the TV, e.g., lines that should be straight may appear slightly curved.

### Image Resolution

Your Mitsubishi TV can display the resolutions shown in the chart from standard VGA (640 x 480) through 1920 x 1080 signals at a refresh rate of 60 Hz. The resolution of 1920 x 1080 is supported at refresh rates of 24, 30, and 60 Hz.

In most cases, the computer will select the best resolution match to display on the TV. You can override this setting if you wish. Refer to your computer operating system's instructions for information on changing the screen resolution.

You may need to restart the computer for changes to take effect.

#### Tip

Set the computer's screen saver to display a pattern after several minutes of inactivity. This acts as a reminder that the TV is powered on and the lamp is in use. The lamp is in use whenever the TV is powered on, even if the screen appears dark.

### Computer Display Formats

Press **MORE** then press **0 (FORMAT)** repeatedly to cycle through the TV displays available for your computer's video signal.

Computer Signal	As Displayed on TV Screen			
	Original Format	4 X 3 Standard	16 X 9 Standard	Zoom
VGA 640 X 480				
WVGA 848 X 480				
SVGA 800 X 600				
WSVGA 1064 X 600				

Original Format	Standard	Zoom
XGA 1024 X 768		
PC 720p 1280 X 720		
WXGA 1360 X 768		
SXGA 1280 X 1024		

Original Format	Standard	Reduce
PC 1080p 1920 X 1080		

## Camera Images and Music Files

### 837 Series TVs Only

- The TV can read photo or music files from a USB device. Photos must be in JPEG format and music files must be in mp3 or wma formats. To play music files while displaying a photo slide show, see “USB Media Setup Menu” on the opposite page.
- The TV can display files of still or moving images from a camera through the **Y/VIDEO** port.

### The USB Media Player Menu

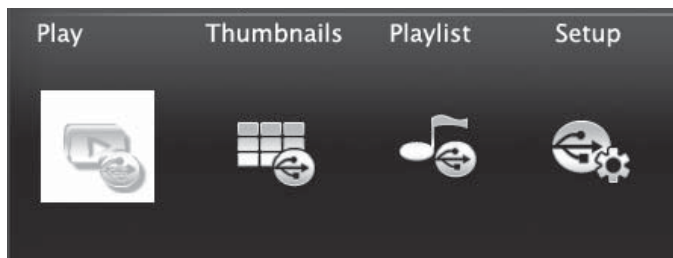

#### Displaying the Menu

- Back up the data on your USB drive before connecting it to the TV. Mitsubishi is not responsible for any file damage or data loss.
- Connect your USB card reader or USB drive to the TV's USB port.  
The **USB Media Player** menu displays while files are being read. Wait until icons appear in the menu before continuing.

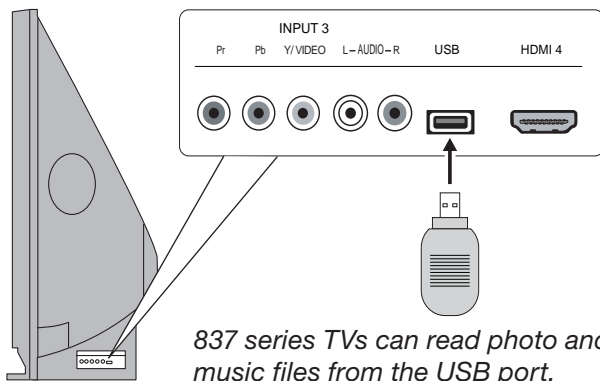

- To use the USB Media Player menu:





Activate any of the menu options	Highlight an icon and press <b>ENTER</b> .
Display the <b>Activity</b> menu.	Press <b>ACTIVITY</b> . Press again to clear.
Display the main menu.	Press <b>MENU</b> . Press again to clear.
Display status for the file source.	Press <b>INFO</b> . Press <b>BACK</b> to clear.

- To resume use of the USB port after switching the TV to a different input, press **ACTIVITY**, choose **View Photos**, and select the USB port.



### Playing a Slide Show or Playlist

Use these keys while playing a slide show or playlist.

 or <b>ENTER</b>	Replays the slide show or playlist.
	Pauses a slide show or playlist.
	Stops a slide show or playlist.
	Displays the previous or next slide.
<b>GUIDE</b>	Rotates an image clockwise in 90° increments.
<b>BACK</b>	Displays the <b>USB Media Player</b> menu.
<b>MENU</b>	Displays the main menu.
<b>ACTIVITY</b>	Displays the <b>Activity</b> menu.
<b>INFO</b>	Displays slide name or track name. Press <b>BACK</b> to clear.

#### IMPORTANT

Always stop playback with  (STOP) or change to a different TV input before disconnecting your USB device.

## Camera Images and Music Files, continued



### Thumbnail and Playlist Menus

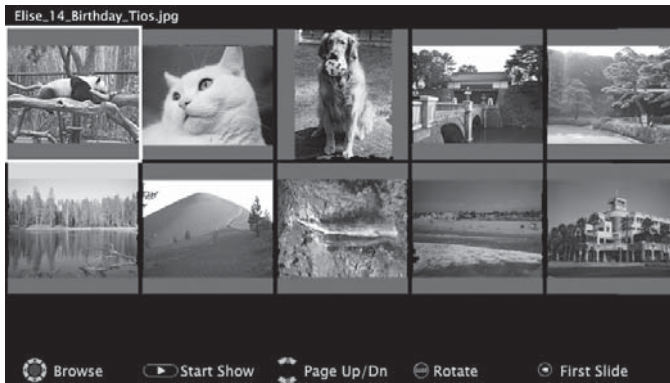

#### JPEG Thumbnail Menu

Use these keys while viewing JPEG thumbnail images or the music tracks in a playlist.

▲ ▼ ◀ ▶	Moves the highlight from item to item.
GUIDE	Rotates a thumbnail clockwise in 90° increments
▶ or ENTER	Plays the slide show or playlist starting with the highlighted item.
▶	Selects the last item on the current page.
◀	Selects the first item on the current page.
⏸ or PAGE UP/DN	Displays the next or previous page of items.
BACK	Displays the <b>USB Media Player</b> menu.
MENU	Displays the main menu.
ACTIVITY	Displays the <b>Activity</b> menu.

#### USB Port Compatible Picture Files

- Still images recorded on digital cameras using the Exchangeable Image File Format, version 2.1 (EXIF 2.1) standard for digital still cameras and Design Rules for Camera File Systems version 1.0 (DCF 1.0)
- Some images opened and resaved on a computer may not play back or may not display in the thumbnail list. This happens if the files were resaved in an incompatible format.
- Full path file names can be no longer than 50 characters and must end in a .jpg extension. Only the first 20 of the 50 characters will display.
- Images on storage devices with a capacity of over 256 MB can take a longer initial time to display.



### USB Media Setup Menu

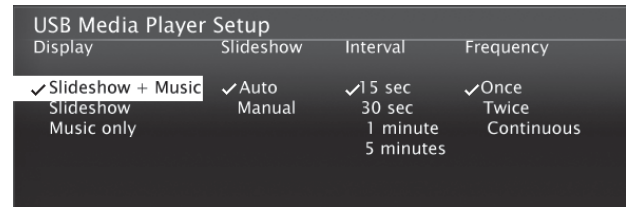

Use the USB **Media Setup** menu set up play of a slide show or playlist.

- If JPEG image files and wma/mp3 files are on the USB device, choose:
  - **Slideshow + Music**
  - **Slideshow**
  - **Music only**
- **Slideshow.** Select either **Auto** or **Manual** advance for the slide show. During manual operation, press **ENTER** to advance to the next slide.
- **Interval.** For automatic advance, select the time interval for display of each slide. The interval you select here is the minimum time between slides; actual time may be longer for larger files.
- **Frequency.** For automatic advance, select the number of times (frequency) to play the complete slide show and/or playlist: **Once**, **Twice**, or **Continuous**.
- Press **BACK** to close the **Media Setup** menu and return to the **Media Player** menu.

#### Notes on Using the USB Port

- The TV ignores all commands while reading files. Wait for icons to appear in the **USB Media Player** menu before continuing.
- Large files or high-capacity storage devices may take a long time to display. The screen will be blank while files are read.
- Use only one source device at a time.
- Back up the data on your USB drive before connecting it to the TV. Mitsubishi is not responsible for any file damage or data loss.

**Note:** Some manufacturers' devices may be incompatible with the TV. If the TV is unable to display your photos, you can:

- Transfer files to a different USB device.
- Use your digital camera's composite video output. See page 30.

**The TV can read JPEG files as created by the camera. If you edit a picture file on a computer and resave the image, the TV may be unable to read the resaved file.**

## Photos and Moving Video as Composite Video

Connect the camera to the TV using a composite video cable if:

- You are unable to see images using the USB port.
- You wish to view moving video from the camera.

Control the slide show or movie through the camera as the TV's **USB Media Player** menu will be unavailable. The display resolution will be standard-definition (480i).

1. Refer to the owner's manual supplied with the camera for instructions needed for this setup.
2. Set the camera's output signal type to **NTSC** and put the camera into playback mode.
3. With the camera still turned on, connect your digital camera's composite video cable (usually yellow) to the TV's **Y/VIDEO** jack. To hear audio, connect the camera's audio output cable to the **AUDIO L** jack.

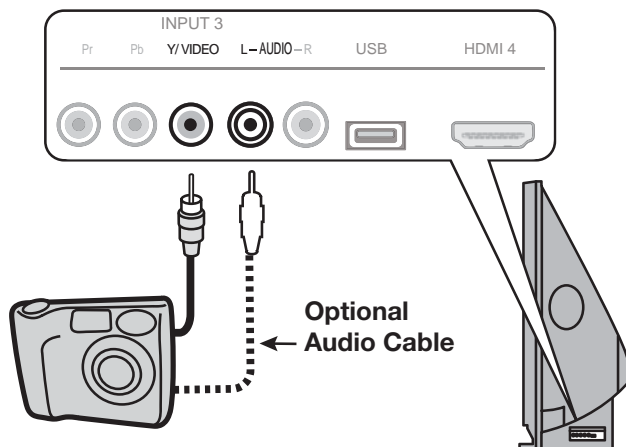

Camera connection using a composite video cable

4. When the **New Device Found** screen displays, assign the name **Camcorder**.
5. Press **BACK** to close the **New Device Found** screen.
6. Press **ACTIVITY**, select **Watch Movie > Cam**, and press **ENTER**.

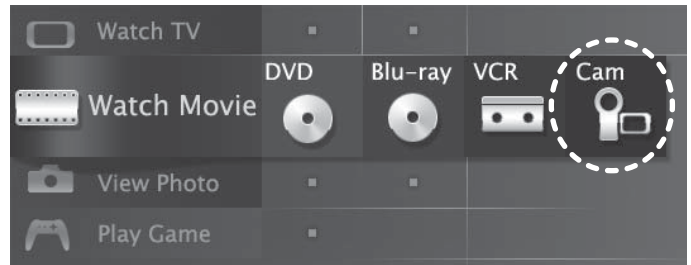

7. If viewing photos, advance through the images manually or set the camera to advance automatically.

## Introduction to Home-Theater Control

This TV offers a choice on home-theater-control systems. This summary offers some examples of the control methods available using the **TV's remote control**. You may wish to use one or more of these methods in your home theater after completing Auto Input Sensing.

### Source device connected directly to the TV

#### Remote Control Programming (Any Connection Type)

Program the remote control to operate the A/V device. To control the device, set the remote control to the correct mode for the device type. See Appendix B, "Programming the Remote Control." In the case of an A/V receiver, use the Audio Lock feature, page 60.

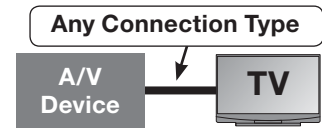

#### CEC-Enabled HDMI Device (HDMI Connection Only)

See Appendix C, "HDMI Control of CEC Devices," page 66.

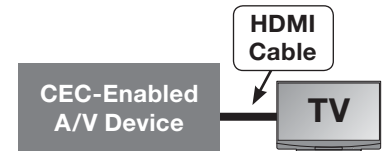

#### 837 Series: NetCommand IR Control (Any Connection Type)

Set up NetCommand IR control of the device's keys as desired. See "IR Emitter Placement," page 46, and "Initial NetCommand Setup," page 47.

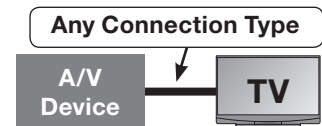

### Source device connected to an A/V receiver connected to the TV

#### CEC-Enabled HDMI A/V Receiver

The TV's remote control may operate some functions of a connected A/V device. You can switch to the device by selecting its icon in the TV's **Activity** menu. See Appendix C, "HDMI Control of CEC Devices," page 66.

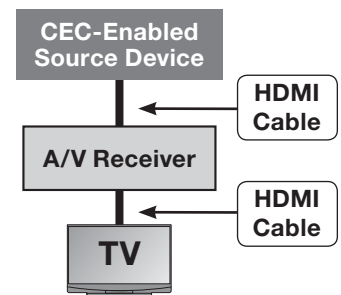

#### 837 Series: A/V Receiver with HDMI Output (no CEC)



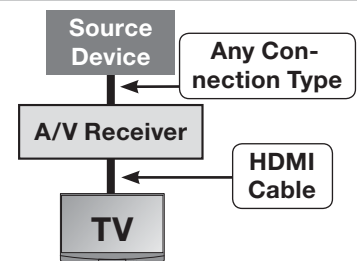

1. Set up NetCommand IR control of the **A/V receiver's** keys as desired. See "IR Emitter Placement," page 46, and "Setting Up A/V Receiver Control," page 52.
2. Set up NetCommand IR control of the **source device's** keys as desired. See "NetCommand Control of a Device Connected to an HDMI A/V Receiver," page 55.







# 4 TV Menus

## Main Menu

Press **MENU** on the remote control to open the main menu and then select from one of these categories.

	<b>Adjust</b>	Customize picture and sound settings.	33
	<b>Captions</b>	Turn closed captions on and off; customize caption displays.	37
	<b>Initial</b>	Perform basic TV setup. Set language, scan (memorize) channels and edit channel options, set the TV clock, set Lamp Mode, set auto-on TV Timer.	38
	<b>Input</b>	Assign names to TV inputs, enable HDMI Control, assign activities to inputs. <b>837 Series.</b> Perform NetCommand IR “learning.”	40
	<b>Lock</b>	Restrict TV use. Disable the control-panel buttons. Set a pass code.	42

## Menu Navigation

	Displays or clears the main menu.
	<ul style="list-style-type: none"> <li>Moves up one menu level.</li> <li>Clears the current menu.</li> </ul>
	<ul style="list-style-type: none"> <li>Moves navigation into options area.</li> <li>Selects an item.</li> </ul>
	Moves the highlight within menus.
	Makes adjustments in some menus.

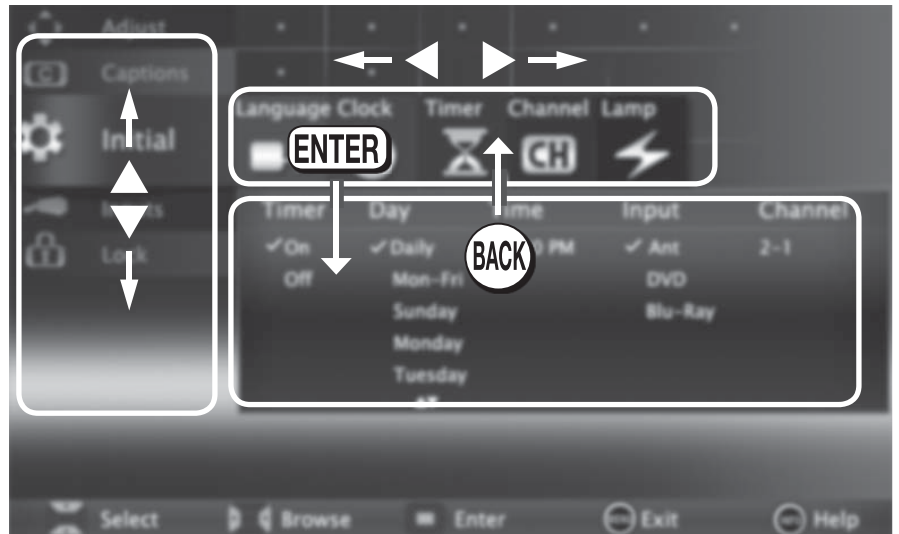





Look for the key guide at  the bottom of each menu.





## Adjust

<b>Picture</b> 	See page 35 for picture adjustments.		
<b>Audio</b> 	See page 36 for audio adjustments.		
<b>Reset</b> 	<ul style="list-style-type: none"> <li>Resets audio and picture adjustments for the current input. Highlight the <b>Reset</b> icon and press <b>ENTER</b> twice.</li> <li><b>Reset</b> has no effect on settings for <b>Balance</b>, <b>Listen To</b>, <b>Language</b>, <b>Film Mode</b>, and <b>Advanced Picture</b>.</li> </ul>		
<b>Global</b> 	<b>Video Mute</b> (non-antenna inputs only)	<b>On</b>	Displays a solid colored background when there is no video signal from the current input. The colored screen reminds you that the TV is powered on when there is no picture. The TV will power off after five minutes without receiving a video signal.
		<b>Off</b>	The screen appears black when there is no video signal from the current input.
	<b>Audio Screensaver</b>	<b>On, Off</b>	Select <b>On</b> to display a random pattern while playing an audio-only input. To use this feature, the input must be either <ul style="list-style-type: none"> <li>Named <b>CD</b> or <b>MP3 Player</b> and selected under the <b>Listen Music</b> activity.</li> <li>or</li> <li>Be the <b>ANT</b> input.</li> </ul> <b>Note:</b> When playing an audio-only input, the TV will power off after 12 hours of inactivity.
	<b>Film Mode</b> (480i and 1080i signals only)	<b>Auto, Off</b>	In <b>Auto</b> , the TV automatically detects and applies film-decoding correction to movies filmed at 24 frames per second. Try the <b>Off</b> setting if images show many jagged edges.
	<b>Smooth 120Hz</b>	<b>Off, On</b>	When <b>On</b> , Smooth 120Hz™ reduces motion blur in action scenes but may show pixel structure during slower motion or in still images.
	<b>Blue Glow</b> (837 series)	<b>On, Off</b>	Select <b>On</b> to see blue accent lighting when the TV is powered on.
 <b>Test Picture</b>	Displays a test picture for use by TV servicers.		



## Adjust, continued

<b>Picture+</b> 		<b>PerfectColor Sliders</b>	Adjusts the saturation (intensity) of six colors for the current image source.
	<b>PerfectColor</b>	<b>PerfectTint Sliders</b> (837 series)	Adjusts six hues for the current image source
<p><b>Using PerfectColor:</b> Highlight the PerfectColor™ icon and press <b>ENTER</b> to display the <b>PerfectColor</b> menu. Settings are retained independently for each TV input.</p> <p><b>Using PerfectTint (837 Series):</b></p> <ul style="list-style-type: none"> <li>To switch between PerfectColor™ and PerfectTint™ adjustments, highlight <b>Adjust Mode</b> and press ◀ ▶.</li> <li>Press ▲ ▼ to move from one color bar to the next.</li> <li>Press ◀ ▶ to change settings.</li> <li>Press <b>CANCEL</b> to restore default settings.</li> <li>Press <b>MENU</b> to return to the main menu.</li> </ul>			
	<b>Advanced Picture</b>	<p><b>Advanced Picture</b> allows you to save highly customized picture adjustments for each input. <b>Mitsubishi recommends a professional installer make these adjustments.</b></p>	
	<ol style="list-style-type: none"> <li>Press <b>MENU</b>. Under <b>Picture+</b>, highlight the <b>Advanced Picture</b> icon and press <b>ENTER</b>.</li> <li>With <b>Picture Mode</b> highlighted, press <b>ENTER</b> to change from blank (undefined) to <b>ADV</b>. <b>837 Series:</b> Choose <b>ADV1</b> (daytime settings) or <b>ADV2</b> (nighttime settings)</li> <li>Use ▲ ▼ to highlight an option you wish to change and press <b>ENTER</b>.</li> <li>Press ◀ ▶ to change settings.</li> <li>Use ▲ ▼ to navigate through the screen to additional options and press ◀ ▶ to change settings.</li> <li>Press <b>MENU</b> to close the menu. The <b>Advanced Picture</b> adjustments will be in effect for the current input.</li> </ol> <p><b>To use the custom Picture Mode at a later time</b> Press <b>MENU</b> and go to <b>Adjust &gt; Picture &gt; Picture Mode</b> and:</p>		
<b>737 and C9 Series</b> <ul style="list-style-type: none"> <li>Select <b>SPECIAL</b> if settings were saved by your professional installer.</li> <li>Otherwise select <b>ADV</b>.</li> </ul>		<b>837 Series</b> <ul style="list-style-type: none"> <li>Select <b>ISF Day</b> or <b>ISF Night</b> if settings were saved by your professional installer.</li> <li>Otherwise select <b>ADV1</b> or <b>ADV2</b>.</li> </ul>	
<p><b>To return to the default values for Advanced Picture</b> Display the <b>Picture+ &gt; Advanced Picture</b> menu and:</p>			
<b>737 and C9 Series</b> Highlight <b>RESET Pic Mode</b> and press <b>ENTER</b> .		<b>837 Series</b> <ol style="list-style-type: none"> <li>Highlight the <b>Advanced Picture</b> mode to change.</li> <li>Highlight <b>RESET Pic Mode</b> and press <b>ENTER</b>. Repeat this separately for both <b>ADV1</b> and <b>ADV2</b>.</li> </ol>	
<b>3D Mode</b> 	<b>3D Mode</b>	<b>On, Off</b>	Use the <b>On</b> setting for video games and movies that require 3-D glasses. This setting applies only to the current input. <b>Note:</b> 3D options are available only for 1080p 60-Hz video sources connected to an HDMI input.
	<b>Glasses L-R</b>	<b>Standard, Reverse</b>	Synchronizes the 3D glasses with the image on screen to provide the best 3D effect. Try <b>Reverse</b> if <b>Standard</b> seems incorrect.



## Adjust, continued



### Picture

Assign names to TV inputs before making video adjustments (**New Device Found** or **Inputs > Name** menu). Adjustments will be reset to the defaults if you name or rename inputs afterwards. To make picture adjustments:

- **From the Adjust > Picture menu:**

1. Press ▲ ▼ to highlight an option.
2. Press ◀ ▶ to adjust.
3. Press **BACK** when finished.

- **While watching TV:** Press the **MORE** key and then **8 (VIDEO)** in the on-screen menu. Press ▲ ▼ to select the video option you want to change. Press ◀ ▶ to change settings.

Picture Mode	<b>Brilliant</b>	For use under bright light; unavailable when the current input is named <b>Game</b> or <b>PC</b> .	Set the Picture Mode first before changing other video settings, as some settings are stored independently for each Picture Mode. Use Picture Modes to get the best image under different viewing conditions.
	<b>Game</b>	Optimizes picture and video processing for gaming consoles. Available only when the name of the input is <b>Game</b> or <b>PC</b> .	
	<b>Bright</b>	For most daytime viewing and <b>x.v.Color</b> sources	
	<b>Natural</b>	For most nighttime viewing and <b>x.v.Color</b> sources	
	<b>Special</b>	Advanced Picture Modes. Contact your professional installer for setup or see "Advanced Picture" on the opposite page.	
	<b>ISF Day, ISF Night</b>	<b>737, C9 series: Special/ADV</b> <b>837 series: ISF Day/ADV1, ISF Night/ADV2</b>	
<b>Contrast</b>	<ul style="list-style-type: none"> <li>• Low contrast shows a variety of shades in darker images</li> <li>• In most home lighting situations, medium contrast looks best.</li> <li>• High contrast shows darker images more uniformly black and makes colors appear more vibrant. High contrast is good for brightly lit environments.</li> </ul>	Adjusts the white-to-black level. Settings are stored independently for each Picture Mode.	
<b>Brightness</b>	Adjusts overall picture brightness. Settings are stored independently for each Picture Mode.		
<b>Color</b>	Adjusts overall color intensity from no color to fully saturated.		
<b>Tint</b>	Adjusts the red-to-green ratio.		
<b>Sharpness</b>	Adjusts picture detail and clarity.		
Color Temp	<b>High</b>	Gives white images a cool cast. May provide the most realistic picture under bright lighting.	Adjusts the white balance. Settings are stored independently for each Picture Mode.
	<b>Low</b>	Gives white images a warm cast. Natural/Color Temp at the low setting displays video at approximately the 6500K industry standard for NTSC pictures.	
Video Noise	<b>High</b>	Use <b>High</b> with poor-quality signals.	Reduces minor noise (graininess) in the picture. Saved by input. This adjustment is not available if the current input is named PC or Game or when 3D is active.
	<b>Medium</b>	Use <b>Medium</b> for moderate noise reduction.	
	<b>Low</b>	Use <b>Low</b> with good-quality signals.	
	<b>Off</b>	Use <b>Off</b> to leave the picture unaltered.	
<b>SharpEdge</b>	<b>On, Off</b>	<b>737, 837 Series.</b> SharpEdge™ adds special edge enhancements to make the image appear sharper. Saved by input.	
DeepField Imager	<b>On, Off</b>	<b>737, 837 Series.</b> DeepField™ Imager dynamically enhances black levels in portions of the screen to provide strong contrast with detail over mixed screen content.	
	<b>Demo</b>	For comparison, displays a split picture to show <b>On</b> (right side) and <b>Off</b> (left side).	



## Adjust, continued



### Audio

To make audio adjustments:

- **From the *Adjust > Audio* menu:**
  1. Press ▲▼ to highlight an option
  2. Press ◀▶ to adjust.
  3. Press **BACK** when finished.
- **While watching TV:** Press the **MORE** key and then **9 (AUDIO)** in the on-screen menu. Press ▲▼ to select the audio option you want to change. Press ◀▶ to change settings.

<b>Speakers</b>	The <b>Speakers</b> option displays only if an A/V receiver or headphone connection has been detected. Detection occurs on the right <b>AVR AUDIO OUTPUT</b> jack and the <b>DIGITAL AUDIO OUT</b> jack. An A/V receiver can also be detected on an HDMI jack.	
	<b>TV</b>	Turns on the internal TV speakers.
	<b>AV Receiver</b>	Turns off the TV speakers so you hear sound only from a connected A/V receiver. <b>Note:</b> When you disconnect an analog A/V receiver, be sure to change the <b>Speakers</b> setting to <b>TV</b> to hear sound from the TV speakers.
	<b>Headphones</b>	Turns off the TV speakers so you hear sound only from connected headphones. See “7. AVR AUDIO OUTPUT,” page 16. This option is not available if <b>DIGITAL AUDIO OUTPUT</b> is connected.
<b>Bass</b>	Controls volume of low-pitched sound from the TV speakers.	
<b>Treble</b>	Controls volume of high-pitched sound from the TV speakers.	
<b>Balance</b>	Controls audio balance between the right and left TV speakers	
<b>Sound Mode</b>	<b>Stereo</b>	No special audio effects from the TV speakers
	<b>Surround</b>	Modifies audio from the TV speakers. <ul style="list-style-type: none"> <li>• For monaural (non-stereo) programs, creates a simulated stereo effect.</li> <li>• For stereo programs, creates a simulated surround sound effect.</li> </ul>
<b>Listen To</b> Available only for analog channels from the <b>ANT</b> input	<b>Stereo</b>	The TV plays stereo broadcasts in stereo and mono broadcasts in mono. The word <b>Stereo</b> is displayed when you tune to a channel broadcasting in stereo.
	<b>Mono</b>	Reduces background noise. Use when receiving a weak stereo audio signal. All audio is played as mono with this setting.
	<b>SAP</b> (Second Audio Program)	Selects an additional monaural sound track not audible during normal TV viewing. The SAP signal might be related to the program (such as a sound track in a foreign language), or it might be unrelated (such as a weather report). If an SAP signal is broadcast, the letters <b>SAP</b> are displayed when you tune to the channel.
<b>Language</b>	Selects the current language for a digital program from the <b>ANT</b> input. Each digital program may include from zero to seven language choices.  Available only for digital channels from the <b>ANT</b> input.	
<b>Level Sound</b>	<b>On, Off</b>	Reduces differences in sound volume between programming segments, such as the difference between regular broadcast programs and commercial segments.



## Captions

### Captions on Analog Channels

The TV can decode captions from the **ANT INPUT** and the composite **VIDEO** jacks. Broadcasters can send either standard closed captions or text service. Standard closed captions follow the dialogue of the program and display in a small section of the screen. Text-service closed captions often contain information such as weather or news and cover a large portion of the screen.

### Captions on Digital Channels

The TV can decode captions from the **ANT** input only. Broadcasters can send up to six different captioning selections or can send analog captions for a program that originated in analog format. A TV station may broadcast only one or two types of captions or none at all.



#### IMPORTANT

- **Analog text-service options display a large black or gray box on the screen when no signal is being broadcast.**
- **The content of captions is determined by the broadcaster. If captions show strange characters, misspellings, or odd grammar, it is not a malfunction of the TV.**
- **Closed-caption signals are not available through HDMI or component jacks. See the menus for devices connected to these inputs for closed-caption decoding.**

<b>Services</b> 	<b>Digital</b>	<b>On if Mute Caption 1– Caption 6 Off</b>	<ul style="list-style-type: none"> <li>• <b>On if Mute:</b> Displays digital closed-caption signal Caption 1 when audio from the TV speakers is muted. When watching TV, press <b>MUTE</b> to turn closed captions on/off.</li> <li>• <b>Caption 1–Caption 6:</b> Caption signals sent by the broadcaster</li> </ul>
	<b>Analog</b>	<b>On if Mute CC 1–CC 4 Text 1–Text 4 Off</b>	<ul style="list-style-type: none"> <li>• <b>On if Mute:</b> Displays analog closed captions signal CC 1 when audio from the TV speakers is muted. When watching TV, press <b>MUTE</b> to turn captions on/off.</li> <li>• <b>CC 1–CC 4:</b> Standard closed-caption signals</li> <li>• <b>Text 1–Text 4:</b> Text-service signals</li> </ul>
	<b>Analog Background</b>	<b>Gray, Black</b>	Selects either a gray or black text background to make analog closed captions easier to read.
<b>Effects</b>  (for captions from digital channels)	<b>Font</b>	<b>Default Font 1–Font 7</b>	<b>Default</b> changes settings to those selected by the captions provider, or, if none, to the TV's own caption defaults. Use Fonts 1 through 7 to give captions on digital channels a custom appearance.
	<b>Font Size</b>	<b>Large Medium Small</b>	<b>Large</b> is the recommended size.
	<b>Font Color</b>	<b>White, Black, Magenta, etc.</b>	Guidelines for setting digital captions: <ul style="list-style-type: none"> <li>• <b>A white font on a black translucent background makes an easy-to-read combination.</b></li> <li>• Use contrasting colors for captions and background.</li> </ul>
	<b>Font Opacity</b>	<b>Translucent, Opaque, Flashing, Transparent</b>	
	<b>Background Color</b>	<b>White, Black, Magenta, etc.</b>	
<b>Background Opacity</b>	<b>Translucent, Opaque, Flashing, Transparent</b>		



## Initial

<b>Language</b> 	<b>English</b> <b>Spanish</b>	Displays on-screen menus in either English or Spanish. <b>Note:</b> To listen to audio in other languages (when available), see <b>Adjust &gt; Audio &gt; Listen To &gt; SAP</b> (analog signal) or <b>Language</b> (digital signal) on page 36.	
<b>Clock</b> 	Set the TV clock to: <ul style="list-style-type: none"> <li>• Use the TV Timer to power on the TV automatically at a preset time</li> <li>• Receive correct updates to ChannelView listings</li> </ul> <b>Note:</b> When the Daylight Savings Time change occurs, you must open this menu and set the TV's clock ahead or back.		
	<b>Time</b>	<ol style="list-style-type: none"> <li>1. With the hour highlighted, press ▲ ▼ to change the hour and the <b>AM/PM</b> indicator. Press and hold to change the hour display quickly.</li> <li>2. Press <b>ENTER</b> to set the hour.</li> <li>3. With the minutes highlighted, press ▲ ▼ to change the minutes. Press and hold to change the minutes display quickly.</li> </ol>	
	<b>Date</b>	<ol style="list-style-type: none"> <li>1. With the month highlighted, press ▲ ▼ to select. Press <b>ENTER</b> to set.</li> <li>2. With the day highlighted, press ▲ ▼ to select. Press <b>ENTER</b> to set.</li> <li>3. With the year highlighted, press ▲ ▼ to select the current year.</li> </ol>	
	<b>Time Zone</b>	<b>Eastern, Central, Mountain, Pacific</b> , etc. The correct time zone is required for accurate ChannelView updates.	
	<b>DST</b>	<b>On, Off</b>	Daylight Savings Time. Select the setting for your area. The correct DST setting is required for accurate ChannelView updates.
<b>Timer</b> 	<b>Timer</b>	<b>On, Off</b>	Select <b>On</b> to enable the Timer.
	The Timer tells the TV to power on automatically at a time you set. Use this menu to set a day, time, input, and channel for the Timer. If the TV is already on at the requested time, the TV will automatically change to the designated channel or input. <ul style="list-style-type: none"> <li>• The TV clock must be set before you can use the Timer feature.</li> <li>• To remind you that the TV Timer has been set, the <b>POWER</b> indicator on the front of the TV flashes slowly while the TV is powered off.</li> <li>• When the Timer turns on the TV, press any key on the remote control to keep it on. Otherwise, the TV will turn off after five minutes.</li> </ul>		
	<b>Day</b>	<b>Daily, Mon-Fri</b> , (every) <b>Sunday</b> , (every) <b>Monday</b> , (every) <b>Tuesday</b> , etc. Select the day or days of the week for the Timer to turn on the TV.	
	<b>Time</b>	To set the time for the TV to come on: <ol style="list-style-type: none"> <li>4. With the hour highlighted, press ▲ ▼ repeatedly to change the hour and the <b>AM/PM</b> indicator. Press and hold to change the hour display quickly.</li> <li>5. Press <b>ENTER</b> to highlight the minutes.</li> <li>6. Press ▲ ▼ to change the minutes. Press and hold to change the minutes display quickly.</li> </ol>	
	<b>Input</b>	<b>Ant, DVD, VCR</b> , etc. Select the input you want displayed when the TV comes on. Choose from the defined and enabled inputs that appear in the <b>Activity</b> menu.	
	<b>Channel</b>	If the source is the <b>ANT</b> input, select a channel number by pressing ▲ ▼ or press and hold to scroll through channels.	



## Initial, continued

<b>Channel</b>  <b>(Channel Management)</b>	<b>Ant Air, Ant Cable</b>	<b>You must perform a channel scan to receive digital channels.</b> <b>Scan</b> searches for broadcast channels and adds them to TV memory. To start channel scan:
	<b>Scan</b>	<ol style="list-style-type: none"> <li>Highlight one of the input selections based on your connection to the <b>ANT input</b>:             <ul style="list-style-type: none"> <li><b>Air</b> when connected to an indoor or outdoor antenna.</li> <li><b>Cable</b> when connected to direct cable (no cable box)</li> </ul> </li> <li>Press <b>▶</b> to highlight <b>SCAN</b>.</li> <li>Press <b>ENTER</b> to start channel memorization.</li> </ol>
	<b>Edit</b>	After channel scan, <b>Edit</b> lets you add and delete memorized channels. <ul style="list-style-type: none"> <li>Press <b>PAGE DN/UP</b> to jump to the next or previous page of channel numbers.</li> <li>Press <b>▲▼◀▶</b> to move through all channel numbers, one at a time.</li> </ul>

### Notes on Scan and channel memorization

- Channel memorization may take up to 15 minutes to complete.
- To stop channel memorization before completion, press **CANCEL**. Channels already added are retained.
- When watching TV, press **CH ▲▼** to move through memorized channels.
- To add a digital channel that does not appear in the **Edit** menu without repeating channel memorization:
  - Look up the physical channel number for the new digital channel. See the website [www.antennaweb.org](http://www.antennaweb.org) for help.
  - Press **ACTIVITY** and select the **ANT** input.

- Use the number keys and **CANCEL** key to enter the physical channel number followed by “-1” and **ENTER**. For example, for physical channel 36, press

**3 6 CANCEL 1 ENTER.**

The TV will search for a digital channel on the channel 36 frequency. When it finds the channel, it will:

- Add the channel to memory.
  - Change the channel number to the virtual channel number sent by the broadcaster.
  - Add to memory any associated sub-channels.
- Rememorize channels if you move the TV to a different geographic area with a different channel line-up.

### Adding/Deleting Channels Using the Channel Edit Menu

- Channels marked with a check are in memory.
- To add or delete a channel from memory, highlight the channel number and press **ENTER**.
- To add a single digital channel not in the list, see the notes under **Scan** on this page.
- Digital channels are listed by virtual channel number with the physical channel number shown in small gray text. See below for an explanation of these terms.
  - Virtual Channel Number** (digital channels only). A channel number sent by a local broadcaster. Usually the virtual number is associated with the corresponding analog channel number. For example, a broadcaster may associate digital channel 2-1 with their analog channel 2.
  - Physical Digital Channel Number**. The channel number officially assigned to the actual broadcast frequency; shown on screen in gray text.

<b>Lamp</b> 	<b>Lamp</b>	<b>Standard, Bright</b>	<b>Standard</b> is for most viewing conditions. Use <b>Bright</b> in brightly lit rooms. You may notice increased fan noise when using the <b>Bright</b> setting.
--	-------------	-------------------------	---

 **Inputs**

<b>Name</b> 	<b>Cablebox, Cam(corder), CD, DVD (DVD, DVD2, Blu-ray), DVR, Game (Game, PS, Xbox, Wii), MP3 Player, PC, Satellite, VCR, AVR</b> <b>Delete</b> (deactivated HDMI only) <b>On/Off</b> (ANT only)	<ul style="list-style-type: none"> <li>• Lets you assign or change names of inputs appearing in the <b>Activity</b> menu.             <ul style="list-style-type: none"> <li>- Press ◀ ▶ to move between inputs.</li> <li>- Press ▲ ▼ to select a name.</li> <li>- You cannot change the name of the current input; you must first switch to another input. If you have only one input, such as a cable box, make sure the <b>Ant</b> input is <b>On</b> and switch to <b>Antenna</b> in the <b>Activity</b> menu before renaming the single input.</li> </ul> </li> <li>• Lets you turn the <b>Ant</b> input <b>On/Off</b> (to display/hide it in the <b>Activity</b> menu).</li> <li>• Lets you delete unused HDMI inputs from the <b>Activity</b> menu.</li> <li>• A CEC-enabled tuner can be named either <b>Cable Box</b> or <b>Satellite</b>.</li> <li>• A CEC-enabled DVD player can be named <b>DVD</b>, <b>DVD2</b>, or <b>Blu-ray</b>.</li> </ul>
--	---	---

**General Notes**





When you change an input name in the **Name** menu and then exit the **Name** menu:

- The name is changed
- The icon in the **Activity** menu is changed
- Audio and video settings are changed to the defaults for the new device type.
- **837 Series:** All previous NetCommand IR “learning” for the input is erased.

**Notes for HDMI devices**

- **Disconnecting an HDMI device:** When you disconnect an HDMI device, the icon remains in the **Activity** menu until you remove it. Select **Delete** in the **Inputs > Name** menu to remove an unwanted icon for an HDMI input.
- If the **New Device Found** screen does not display as expected when you connect an HDMI device, see “Reactivating Auto Input Sensing for an HDMI Input,” page 11.
- **HDMI Control and CEC-Enabled Devices:** See Appendix C, “HDMI Control of CEC Devices,” page 66.
- **If case of CEC conflicts:** Turn off CEC signals in one of these ways:
  - Turn off the TV’s HDMI Control signals to the device.
  - Turn off each device’s internal CEC capability.

See Appendix C for the TV’s HDMI Control or, to turn on/off a specific device’s response to CEC signals, see the device owner’s manual.

<b>Learn</b> 	<b>837 Series</b> Sets up or changes NetCommand IR control of the current viewing device. See “About NetCommand IR Control,” page 45.	
<b>AVR</b> 	<b>837 Series</b> Sets up or changes NetCommand IR control of an A/V receiver. See “NetCommand IR Control of an A/V Receiver” on page 51.	
<b>HDMI Control</b> 	<b>On, Off</b>	Select <b>On</b> or <b>Off</b> to enable or disable the TV’s control of a CEC-enabled device. See Appendix C for use of this feature.
<b>Activity</b> 	<ul style="list-style-type: none"> <li>• Lets you customize the <b>Activity</b> menu choices for the current input.</li> <li>• Highlight the activity name and press <b>ENTER</b> to make changes.</li> <li>• See “How is the Activity Menu Generated?” on the opposite page.</li> </ul>	





## Inputs, continued

### How is the Activity Menu Generated?

The TV automatically generates the **Activity** menu based on recognized inputs. If the inputs have been named as device types, the TV groups the device types based on how they can be used. The device names used for groupings are those assigned in the **New Device Found** menu or the **Inputs > Name** menu. The table below summarizes the device groupings that can appear in the **Activity** menu.

#### Key

- ✓ Activity assignments made automatically by the TV.
- X Activity assignments you can make using the **Inputs > Activity** menu.

	Watch TV	Watch Movie	Play Game	View Photos	Listen Music
Antenna	✓				
AV Receiver	✓				✓
Blu-ray		✓		X	X
Cable Box	✓				
Camcorder		✓			
CD/Audio					✓
DVD		✓			X
DVD2		✓			X
DVR	✓				
Game			✓		
MP3 Player		✓			✓
PC	✓	X	✓	X	X
PS		✓	✓	X	
Satellite	✓				
USB				✓	X
VCR		✓			
Wii		X	✓		
Xbox		X	✓		



## Lock

### TV Locks

	<b>Parental</b> <b>Lock by Program Ratings</b> Restricts access using U.S.-based ratings sent by broadcasters.
	<b>Time</b> <b>Lock by Time</b> Restricts TV use by time of day.
	<b>Panel</b> <b>Lock Control Panel</b> Disables the buttons on the TV's control panel. Use this option if small children in the home try to press control-panel buttons.
	<b>Other</b> <b>Lock by Other Program Ratings</b> Restricts access using non-U.S.-based ratings sent by broadcasters.

### Pass Codes

#### Setting a Pass Code

You are prompted to enter a pass code whenever you select **Lock** on the main menu. To set a pass code for the first time:

1. Press **MENU** and highlight **Lock**. A screen prompting you for a pass code will display.
2. Input a four-digit pass code using the number keys on the remote control.
  - Press **CANCEL** to delete a number and move back one space.
  - Press **MENU** or **BACK** to close the menu without setting a pass code.
3. Press **ENTER** to set the pass code.

#### Resetting a Pass Code

See the procedure in Appendix A.

### Parental Menu

The TV comes from the factory with the rating locks turned off and with pre-set U.S. ratings TV-PG and movie rating PG. Turn on blocking for U.S. ratings to activate these rating restrictions. Use the **Lock** > **Parental** menu to change the level of blocking with U.S. ratings.

Any time you change the channel or device, it may take up to five seconds for the rating restrictions to take effect.

### Other Menu (Alternate Rating System)

This TV can recognize new rating systems that may come into effect in the future. The **Other** menu allows you to block digital programming when such systems come into effect.

The first time you tune to a channel broadcasting an alternate rating system, the TV defaults to the most restrictive setting if the **Lock** menu > **Other Lock** option is set to **On**. Use this menu to change the allowed rating if you are unable to watch a program rated with an alternate system.

### Bypassing TV Locks

- If you try to watch a blocked program or the TV is locked by time, a notice will appear prompting you for a pass code. To use the TV, input your four-digit pass code and press **ENTER**.
  - To reactivate the locks after using a pass code, power the TV off and then on.
  - To reactivate only the parent ratings lock, change to a different channel or device.
- If a program is blocked, you can still use the TV without entering a pass code. Change to a channel airing an allowed program or change to another device.

#### Important Notes on Rating Locks

- **Parental** menu rating locks apply only to channels and signals received on the **ANT** and composite **VIDEO** jacks.
- **Other** menu rating locks apply only to digital channels received on **ANT**.
- When viewing a cable box, satellite receiver, or other device connected to the component **Y Pb Pr** or **HDMI** inputs, check the device's owner's guide for parental locks.



## Lock, continued



## Parental

<b>Lock</b>	<b>Off, On</b>	Disables or enables blocking based on V-Chip signals and the U.S. rating system.	
<b>Start Time</b>	Sets the time of day for enforcement of rating restrictions set in the <i>Parental</i> menu.		
<b>Stop Time</b>	1. Highlight the hour digits for <b>Start Time</b> .		
	2. Press ▲ ▼ repeatedly to change the hour and associated <b>AM/PM</b> indicator. You can also just press and hold to move quickly through the numbers.		
<b>Stop Time</b>	3. Press <b>ENTER</b> to highlight the minutes.		
	4. With the minutes digits highlighted, press ▲ ▼ repeatedly to change the minutes. You can also just press and hold to move quickly through the numbers.		
	5. Highlight the <b>Stop Time</b> digits and set the time as described above.		
<b>Note:</b> To make rating restrictions active 24 hours a day, make <b>Start Time</b> and <b>Stop Time</b> the same.			
<b>TV Rating</b>	<b>TV-Y</b>	<b>Youth.</b> For children under 7.	Highlight the rating level you wish to change and press <b>ENTER</b> to block it (🔒) or allow it (🔓).  You can apply supplemental content blocking to the age-based ratings by using the TV content categories listed below.
	<b>TV-Y7</b>	<b>Youth 7</b> and older.	
	<b>TV-G</b>	<b>General Audience.</b> For the entire family.	
	<b>TV-PG</b>	<b>Parental Guidance.</b> Parental Guidance recommended; may not be suitable for some children.	
	<b>TV-14</b>	<b>Adolescent 14 and older.</b> Not recommended for children under 14.	
	<b>TV-MA</b>	<b>Mature Audience.</b> For adults only.	
<b>FV</b>	<b>Fantasy Violence.</b> Applies to TV-Y7 only.		<b>TV Content Categories</b>
<b>D</b>	<b>Sexual Dialog.</b> Applies in differing degrees to TV-PG and TV-14.		
<b>L</b>	<b>Adult Language.</b> Applies in differing degrees to TV-PG, TV-14, and TV-MA.		
<b>S</b>	<b>Sexual Situations.</b> Applies in differing degrees to TV-PG, TV-14, and TV-MA.		
<b>V</b>	<b>Violence</b> (graphic or realistic). Applies in differing degrees to TV-PG, TV-14, and TV-MA.		
<b>Movie Rating</b>	<b>G</b>	<b>General Audience.</b> Designed for the entire family.	
	<b>PG</b>	<b>Parental Guidance.</b> Parental Guidance recommended; may not be suitable for some children.	
	<b>PG-13</b>	<b>Parental Guidance, 13 and Older.</b> Not recommended for children under 13.	
	<b>R</b>	<b>Restricted.</b> Restricted in theaters to 17 years old and older unless accompanied by an adult.	
	<b>NC-17</b>	<b>No Children 17 or Under.</b> Restricted in theaters to 18 years old and older.	
	<b>X</b>	<b>Adult.</b> Designed for and restricted in theaters to adult audiences only.	
	<b>Not Rated</b>	No MPAA rating assigned	



## Lock, continued

<b>Time</b>	Blocks all use of the TV during the time period you specify. You must enter a pass code to use the TV when the time lock is in effect.	
	<b>Lock by Time</b>	Enables/disables <b>Lock by Time</b> .
<b>Panel</b>	<b>Lock Time, Unlock Time</b>	<p>To set the lock and unlock times:</p> <ol style="list-style-type: none"> <li>1. Highlight the hour digits for the <b>Lock Time</b>.</li> <li>2. Press <b>▲ ▼</b> repeatedly to change the hour and associated <b>AM/PM</b> indicator. To move quickly through the numbers, just press and hold.</li> <li>3. Press <b>ENTER</b> to set the hour and highlight the minutes.</li> <li>4. With the minutes highlighted, press <b>▲ ▼</b> repeatedly to change the minutes. To move quickly through the numbers, just press and hold.</li> <li>5. Highlight the <b>Unlock Time</b> digits and set the time as described above.</li> </ol> <p><b>Note:</b> To make Lock by Time active 24 hours a day, make <b>Start Time</b> and <b>Stop Time</b> the same.</p>
	<b>Off, On</b>	<p><b>On</b> locks and <b>Off</b> unlocks the buttons on the TV's control panel. Use this option if small children try to press TV buttons.</p> <ul style="list-style-type: none"> <li>• To release the Panel Lock from the TV's control panel, press and hold the <b>ACTIVITY</b> button for ten seconds. If the TV is powered off, press <b>POWER</b> after the lock releases to make the TV power on.</li> <li>• To reactivate the lock, return to this menu and change the setting to <b>On</b>.</li> </ul>
<b>Other</b>	<b>Other Menu Options (alternate rating system)</b>	
	This TV can recognize new rating systems that may come into effect in the future. The <b>Other</b> option remains grayed out until the TV receives a signal using an alternate rating system. Such alternate rating systems will apply only to digital programming received on the <b>ANT</b> input.	
	<b>Lock</b>	<b>On, Off</b> Enables/disables program blocking.
	<b>System Name</b>	The rating system available for the channel
	<b>Group</b>	Rating groups available in the rating system shown on the screen. Rating groups are defined by the rating system in effect.
<b>Rating</b>	Rating restrictions available in the selected rating system and group. Highlight the rating and press <b>ENTER</b> to check (block) or uncheck (allow) rated content.	

# 5 NetCommand IR Control

## *About NetCommand IR Control*

- **NetCommand IR home-theater control is available on 837 series models.**
- **IR emitter cables are available for purchase from Mitsubishi.** Visit [www.mitsuparts.com](http://www.mitsuparts.com) or call 800-553-7278 and request one of the following:
  - **242D483020** (two-ended cable)
  - **299P254020** (four-ended cable).
- NetCommand setup is optional.
- You can perform NetCommand setup when the TV first recognizes a device during Auto Input Sensing or at any convenient time afterward.
- NetCommand operates by sending remote control signals from the TV to your other devices via the IR (infrared) emitters, telling the devices to play, record, change inputs, adjust volume, change channels, or perform other functions. All this is accomplished with the TV's remote control left in TV mode.
- You may wish to use NetCommand IR control to supplement control of CEC-enabled devices.

### ***Important Note on NetCommand***

**Be sure to connect the IR emitter cable to the TV and properly place the emitters so that NetCommand can control your devices.**

## IR Emitter Placement

The NetCommand system uses emitters connected to the **IR–NetCommand Output** jack to control other devices such as DVD players, cable boxes, satellite receivers, and VCRs.

**IR emitter cables are available for purchase from Mitsubishi.** Request either part number 242D483020 (two-ended cable) or part number 299P254020 (four-ended cable).

1. Connect the plug end of the supplied IR emitter cable to the **IR–NetCommand Output** jack on the TV back panel.
2. When the **New Device Found** screen displays, highlight **EXIT** and press **ENTER**.

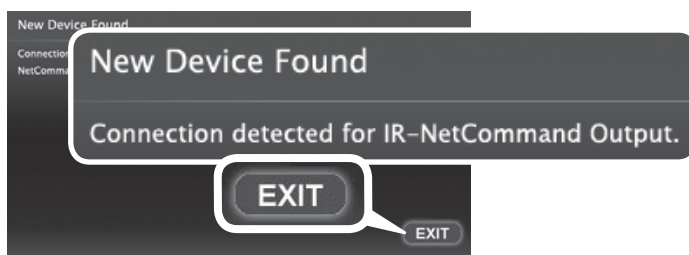

The **New Device Found** screen displays when you connect the IR emitter.

3. Position the emitter end with the emitter bulb facing the device's remote control sensor. The bulb emits infrared light in a cone-shaped pattern. Place the bulb far enough from the sensor to allow the cone pattern to reach the sensor.

In some cases, the emitter works better facing downward from the top of the device. Experiment to find what works best.

4. Secure the emitter ends in place using double-sided tape.
5. Place any unused ends behind the devices to prevent stray signals from reaching the IR sensors.

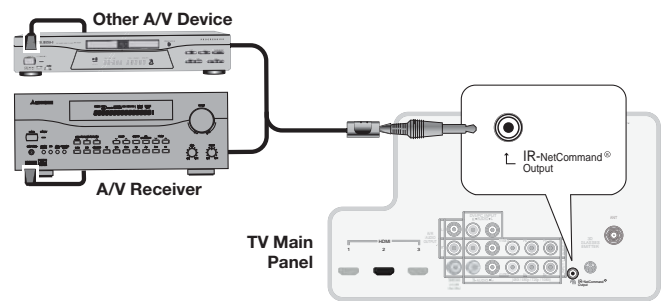

Connecting IR–NetCommand Output

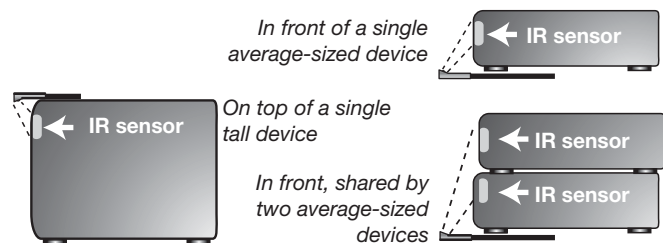

Place IR emitters so the signal can be “seen” by the IR sensor on each device.

### If You are Unable to Locate a Device's IR Sensor

- The IR sensor is usually behind the plastic window of the front display panel. Using a flashlight, you may be able to see it as a round or square cutout.
- If you cannot see the sensor and the device's Owner's Guide does not specify the location, do the following using the device's remote control.
  1. Starting at one end of the plastic window, hold the device's remote control about one-half inch from the front of the device and press the **POWER** key.
  2. If the device does not respond, move the remote control one inch toward the center and try again. Repeat until the device responds.
  3. Repeat the previous steps starting at the other end of the window. The sensor will be between these two points.

#### **IMPORTANT**

Position IR emitters so that each device's sensor “sees” the signal from only one emitter. Otherwise, a device receiving signals from multiple sources (remote controls, IR emitters) may not respond at all.

## Initial NetCommand Setup

To perform this procedure, you need:

- The remote controls for both the TV and the device you want to control.
- An IR emitter cable available from Mitsubishi.

**Note:** To set up an A/V receiver, see “Setting Up A/V Receiver Control,” page 52.

1. Connect and position the IR emitters for the devices you wish to control. See “IR Emitter Placement” on the opposite page.
  2. Set the **TV’s** remote control to **TV** mode and power on the TV.
  3. Open the NetCommand **Learn** screen as follows:
    - If working from the **New Device Found** screen after the device is first detected, highlight **NetCommand** and press **ENTER** to open the **Learn** screen for the device.
    - If performing NetCommand setup at any time after the device has been recognized through Auto Input Sensing:
      - a. Press **ACTIVITY**.
      - b. Highlight the desired input icon and press **ENTER** to switch to that input.
      - c. Press **MENU**, highlight **Inputs**, and highlight **Learn** to open the **Inputs > Learn** screen for the device.
  4. The first function highlighted in the **Learn** screen is always **Power On**. Aim the **TV’s** remote control at the TV and press **ENTER** to begin learning for that function.
  5. When the **Power On** text starts flashing, aim the **device’s** remote control at the TV and hold the **POWER** key until a check mark appears next to **Power On**.
    - If the text stops flashing before the check mark appears, repeat the previous step.
    - To remove the key from NetCommand control, press the **CANCEL** key while the key name is highlighted.
  6. Press the **▲ ▼ ◀ ▶** keys on the **TV’s** remote control to highlight other keys on the list. Repeat steps 4 and 5 for each additional function you wish to control through NetCommand.
- Note:** Device keys in the far right column will be associated with the remote control’s **MORE** key when “learned.” See the table on page 49.
7. If the device has a separate **POWER OFF** key, press **▲ ▼ ◀ ▶** on the **TV’s** remote to highlight **Power Off**. Repeat the earlier steps to “learn” the **POWER OFF** key. **If the device has no POWER OFF key, skip this step.**
  8. Press **BACK** to finish NetCommand “learning” for the current device.

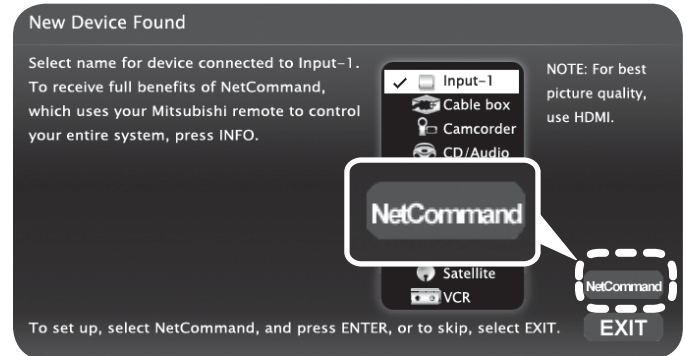

From the **New Device Found** screen, highlight **NetCommand** and press **ENTER** to open the **Learn** screen.

Device-specific keys in the rightmost column can be accessed with the **MORE** key after “learning.”

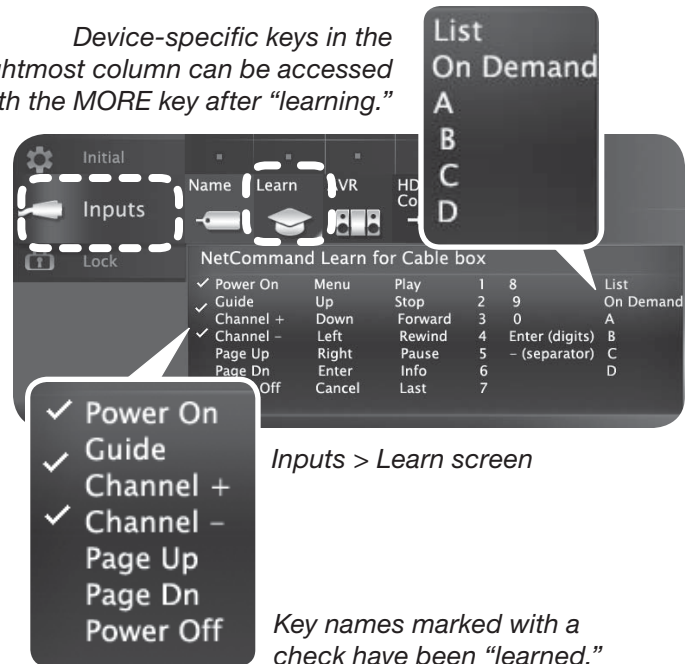

*Inputs > Learn screen*

*Key names marked with a check have been “learned.”*

## Adding or Removing Device Keys from NetCommand Control

1. Switch the TV to the device. Press **ACTIVITY**, highlight the device’s icon, and press **ENTER**.
2. Open the **Inputs** menu and highlight the **Learn** icon.
3. When the **Learn** screen displays:
  - **To add keys:** Continue as described earlier under “Initial NetCommand Setup” on this page.
  - **To delete keys:** Highlight the name of the key you wish to delete and press **CANCEL** on the **TV’s** remote control to clear the check mark.

## Operating NetCommand-Controlled Devices

### Controlling Most Device Types

As an example of NetCommand control, if you are watching your cable box and you wish to tune to the next channel higher, press **CHANNEL UP**. NetCommand then sends the “learned” channel-up control signal to the cable box.

1. Perform NetCommand setup for the device as described in this chapter.
2. When you wish to use the device, press **ACTIVITY**.
3. Press **▲▼◀▶** to highlight the icon for the device.
4. Press **ENTER** to switch the TV to the device.

**Note:** if you have set up automatic input switching for the A/V receiver, the A/V receiver will automatically switch to the correct input for the device.

5. To operate the device using the **TV's** remote control, press the side button to put the remote control into **TV** mode.
6. Point the remote control at the **TV** (not the device) and press the key for the desired function.
7. Press the **MORE** key to access additional key functions you may have “learned” for the device.

### Special Operation Methods

Key Name in Learning Screen	Special Operation Description and Setup	How to Use
<b>Power On</b>	<p><b>Manual Power On/Off</b></p> <p>Use for devices that have only one <b>POWER</b> key.</p>	<ol style="list-style-type: none"> <li>1. Press <b>ACTIVITY</b>.</li> <li>2. Press <b>▲▼◀▶</b> to highlight the icon for the device to be powered on or off.</li> <li>3. With the <b>Activity</b> menu still displayed, press <b>POWER</b> to send the power signal; you may need to press <b>POWER</b> twice.</li> </ol> <p><b>Note:</b> If you press <b>POWER</b> without the <b>Activity</b> menu displayed, the TV will turn off.</p> <ol style="list-style-type: none"> <li>4. Press <b>ENTER</b> to switch the TV to the device.</li> </ol>
<b>Power On</b> <b>Power Off</b>	<p><b>Automatic Power On/Off</b></p> <p>This feature is only for devices that have separate <b>POWER ON</b> and <b>POWER OFF</b> keys on their original remote controls. If your device does not have a separate <b>POWER OFF</b> key, do not use the <b>Power Off</b> learning position; use only the Manual Power ON/OFF method described above.</p> <p>In the NetCommand <b>Learn</b> screen:</p> <ol style="list-style-type: none"> <li>a. “Learn” the <b>Power On</b> command in the <b>Power On</b> learning position.</li> <li>b. “Learn” the <b>Power Off</b> command in the <b>Power Off</b> learning position.</li> </ol>	<ul style="list-style-type: none"> <li>• <b>To Power On the Device</b> <ol style="list-style-type: none"> <li>1. Press <b>ACTIVITY</b>.</li> <li>2. Press <b>▲▼◀▶</b> to highlight the icon for the device to be powered on or off.</li> <li>3. Press <b>ENTER</b> to switch the TV to the device and NetCommand will send the <b>Power On</b> command to the device.</li> </ol> </li> <li>• <b>To Power Off the Device</b> When you turn the TV off, the TV sends all learned <b>Power Off</b> commands to all devices.</li> </ul>
<b>Menu</b>	<p><b>Displaying a Menu for the Current Device</b></p> <p>“Learn” the <b>MENU</b> key on the original remote in the <b>Menu</b> learning position.</p>	<p>Press <b>MORE</b> and then 1 to send the menu command to the current device.</p>
<b>Guide</b>	<p><b>Displaying the On-Screen Program Guide (cable box or satellite receiver)</b></p> <ol style="list-style-type: none"> <li>1. “Learn” the <b>GUIDE</b> key on the original remote in the <b>Guide</b> learning position.</li> <li>2. Learn the <b>PAGE UP</b> and <b>PAGE DOWN</b> keys of the original remote in the <b>Page Up</b> and <b>Page Down</b> learning positions.</li> </ol>	<ol style="list-style-type: none"> <li>1. While watching the device, press <b>GUIDE</b> to display the guide.</li> <li>2. Press <b>PAGE UP/DOWN</b> (⤴ ⤵) to send the <b>Page Up/Dn</b> commands for the guide.</li> </ol>



Key Name in Learning Screen	Special Operation Description and Setup	How to Use
<b>Enter</b>	<p><b>ENTER-Key Functions (cable boxes, satellite receivers, etc.)</b></p> <p>Some devices have two keys that have “enter” functions. One key is for menus and is often labelled <b>SELECT</b> or <b>OK</b>. A second key is for use with number keys for direct channel selection. NetCommand uses the same <b>ENTER</b> key for both operations.</p> <p>When <b>ENTER</b> has a menu or guide function or when the original remote control uses the same key for menus and channel selection: Learn the <b>ENTER</b>, <b>SELECT</b>, or <b>OK</b> key in the NetCommand <b>Enter</b> learning position.</p>	<ol style="list-style-type: none"> <li>1. Press <b>MENU</b> or <b>GUIDE</b> to display the device’s menu or guide.</li> <li>2. Press <b>ENTER</b> within the menu and NetCommand will send the <b>Enter</b> signal for menus.</li> </ol>
<b>Enter (digits)</b>	<p>When <b>ENTER</b> is for channel changes, i.e., the original remote control has a separate <b>ENTER</b> key for this function):</p> <p>Learn the <b>ENTER</b> key for channel selection in the NetCommand <b>Enter (digits)</b> learning position. Use this learning position only if the original remote control has separate keys for <b>Enter</b> in menus and <b>Enter</b> for channel selection.</p>	<p>Press digit key(s) and then press <b>ENTER</b>. NetCommand will send the <b>Enter</b> signal for channel selection.</p>
<b>Cancel</b>	<p><b>CANCEL as the Cancel or Exit Function</b></p> <p>“Learn” the <b>Cancel</b> or <b>Exit</b> function in the NetCommand <b>Cancel</b> learning position</p>	<ol style="list-style-type: none"> <li>1. Press <b>MENU</b> or <b>GUIDE</b> to display the menu or guide.</li> <li>2. Press <b>CANCEL</b> and NetCommand will send the <b>Cancel</b> or <b>Exit</b> signal.</li> </ol>
<b>— (separator)</b>	<p>The symbol “—” can serve as the separator between a digital channel’s main and sub-channel digits, e.g., digital channel 12-1 (main channel is 12, sub-channel is 1).</p> <p>“Learn” the channel separator function in the NetCommand <b>— (separator)</b> learning position.</p>	<p>Press digit key(s) and press <b>CANCEL</b>. NetCommand will send the channel-separator signal.</p>

## The MORE Key Menu and NetCommand

Perform NetCommand setup for these device-specific keys and then access their functions with the **MORE** key.

Device Key	VCR	Cable/ SAT	DVD/ DVR	A/V Receiver
<b>Menu</b>	✓	✓		✓
<b>Input</b>	✓			✓
<b>SP/EP</b>	✓			
<b>List</b>		✓		
<b>On Demand</b>		✓		
<b>A</b>		✓		
<b>B</b>		✓		
<b>C</b>		✓		
<b>D</b>		✓		























Device Key	VCR	Cable/ SAT	DVD/ DVR	A/V Receiver
<b>Top Menu</b>			✓	
<b>Angle</b>			✓	
<b>Audio (DVD)</b>			✓	
<b>Subtitle</b>			✓	
<b>Repeat</b>			✓	
<b>Bonus View</b>			✓	
<b>Setup</b>			✓	
<b>Surround</b>				✓
<b>Night</b>				✓

## Operating NetCommand-Controlled Devices, continued

### NetCommand Specialized Device Keys

Refer to this chart when “learning” device keys. “Learn” some, all, or none of the keys used for each device type.

See page 48 for more on keys marked in the “Special Operation Method” column.

Key Name in Learning Screen	Function	Name on TV Remote Control	See Special Operation Method Table
<b>Power On</b>	Power On or Power ON/OFF (toggle)		✓
<b>Guide</b>	On-Screen Program Guide or DVD Disc Menus		✓
<b>Channel +</b>	Next Channel Higher		
<b>Channel -</b>	Next Channel Lower		
<b>Page Up</b>	Page Up in Guides		
<b>Page Dn</b>	Page Down in Guides		
<b>Up</b>	Arrow up		
<b>Down</b>	Arrow down		
<b>Left</b>	Arrow left		
<b>Right</b>	Arrow right		
<b>Enter</b>	Enter or Select (menus)		✓
<b>Cancel</b>	Cancel or erase (menus)		✓
<b>Play</b>	Start playback		
<b>Stop</b>	Stop playback		
<b>Forward</b>	Fast Forward		
<b>Rewind</b>	Rewind/Fast Reverse		
<b>Pause</b>	Pause playback		
<b>Record</b>	Start Recording		
<b>1, 2, 3, 4, 5, 6, 7, 8, 9, 0</b>	Digits	1, 2, 3, 4, 5, 6, 7, 8, 9, 0	
<b>Enter (digits)</b>	Use after entering digits to tune directly to a channel by number		✓
<b>- (separator)</b>	Add digital channel separator between main channel number and sub-channel number		✓
<b>Last</b>	Last Channel Recall		
<b>Info</b>	On-screen status display or information display		May require two keypresses
<b>Power Off</b>	Power Off		✓

# 6 NetCommand IR Control of an A/V Receiver

Several types of A/V receiver control can be set up using the **Inputs > AVR** menu.

- **Power and volume.** See the next page.
- **Audio switching.** For most equipment setups, see “Case 1: Automatic A/V Receiver Switching to the TV Audio Input” page 53.
- **Audio switching and surround sound.** To set up switching to a surround sound device, see “Case 2: Automatic A/V Receiver Switching to a Surround Sound Device” page 54
- **Audio and video switching over HDMI.** If your A/V receiver has an HDMI output, it may be convenient to send audio and video to the TV over a single HDMI cable through the A/V receiver. See “Case 3: Automatic Audio and Video Switching via HDMI,” page 54.

**Note:** To set up control of other device types, see “Initial NetCommand Setup,” page 47.

## *Controlling an A/V Receiver after NetCommand Setup*

### Switching Audio to and from the A/V Receiver

1. Press **MORE** and then 9 (**AUDIO**).
2. Press **▲** to show the **Speakers** option.
3. Press **▶** to select either **AV Receiver** or **TV**.

### Controlling A/V Receiver Power

#### With Any Connection Type

1. Press **MORE** and then 9 (**AUDIO**).
2. Press **▲▼** to show the **Speakers** option.
3. Press **▶** to select **AV Receiver**.
4. Point the remote control at the **TV** (not the A/V receiver) and press **POWER** to power the A/V receiver on or off.

#### With an HDMI Connection

1. Press **ACTIVITY**.
2. Highlight the A/V receiver icon.
3. Press **POWER**.

### Controlling Other A/V Receiver Functions

With the A/V receiver powered on and selected, the TV's remote control operates the volume and mute functions. Also, when you switch to a device in the **Activity** menu, the A/V receiver automatically switches to the correct audio input for the device.

## Setting Up A/V Receiver Control

### Power and Volume

Perform this setup to control the A/V receiver power and volume with the TV's remote control.

To perform this setup you need:

- The remote controls for both the TV and the A/V receiver.
- An IR emitter cable available from Mitsubishi.

#### Before You Begin

1. Connect your A/V receiver to the TV and any additional devices. See "Setting Up TV Inputs," page 10 and "TV Connections," page 14.
2. Connect the IR emitter cable to the TV and position the IR emitter where it can send signals to the A/V receiver. See "IR Emitter Placement," page 46.
3. Set the **TV's** remote control to **TV** mode using the side button.

#### Setup to Control A/V Receiver Power and Volume

1. Open the **Inputs > AVR** screen in one of two ways:
  - If using the **New Device Found** screen for the A/V receiver, highlight **NetCommand** and press **ENTER** to open the **AVR** screen.
  - If performing NetCommand setup at any time after Auto Sensing: Press **MENU**, highlight **Inputs**, and highlight **AVR** to open the **AVR** menu.
2. The first function highlighted in the **AVR** screen is always **Power**. Aim the **TV's** remote control at the TV and press **ENTER** to begin learning for **Power**.

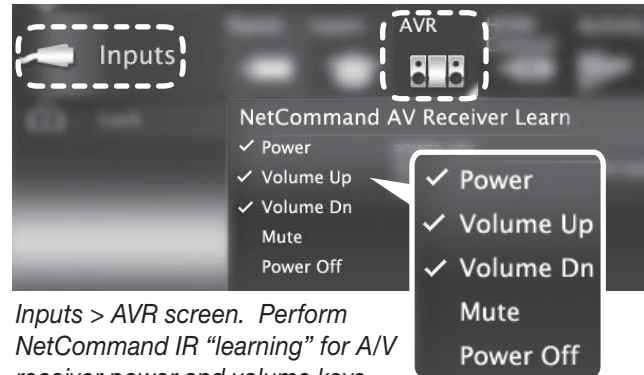

*Inputs > AVR screen. Perform NetCommand IR "learning" for A/V receiver power and volume keys.*

3. When the **Power** text starts flashing, aim the **A/V receiver's** remote control at the TV and hold the **POWER** or **POWER ON** key until a check mark appears next to **Power**.
  - If the text stops flashing before the check mark appears, repeat this step.
  - To remove the key from NetCommand control, press the **CANCEL** key while the key name is highlighted.
4. Press the **▼** key on the **TV's** remote control to highlight other keys in the list. Repeat steps 2 and 3 for each additional function you wish to control through NetCommand.
5. If the A/V receiver has a separate **POWER OFF** key, press **▼** on the **TV's** remote to highlight **Power Off**. Repeat steps 2 and 3 to "learn" the **POWER OFF** key. **If the device has no POWER OFF key, skip this step.**
6. When finished "learning" the power and volume keys, either
  - To watch TV, press **BACK**.
  - To continue with NetCommand setup to control switching of A/V receiver inputs, highlight **NEXT** and press **ENTER**.

#### IMPORTANT

To hear audio sent from the TV to the A/V receiver, you must have:

- Physically connected the TV to the A/V receiver via the analog or digital audio output.
- Assigned, if needed, the name AVR if using an HDMI A/V receiver.
- "Learned" the IR codes for the A/V receiver inputs.
- Assigned the TV's audio output to the correct input in the NetCommand **Inputs > AVR** menu.
- Selected the A/V receiver as the audio source. Press **MORE** then **9 (AUDIO)**, then **▲ ▼** to show the Speakers option, then **▶** to select the A/V Receiver.

## Setting Up A/V Receiver Control, continued

### Automatic Audio or Audio/Video Switching

The following setups enable the A/V receiver to switch automatically to the correct input when you select a device in the TV's **Activity** menu.

Three different connection arrangements are described here. Review the descriptions to find the setup needed for your equipment.

**To hear digital surround sound from a source device you must use the setup described for Case 2.**

To set up control of an A/V receiver you need:

- The remote controls for the TV and A/V receiver.
- An IR emitter cable available from Mitsubishi.
- Connecting cables

#### IMPORTANT

All audio from what you are watching on the TV is always available from both the TV's **AVR AUDIO OUTPUT** and **DIGITAL AUDIO OUTPUT** jacks.

To use the digital surround sound capabilities of your A/V receiver however, you must connect the audio output from your DVD player, satellite receiver, or cable box directly to the A/V receiver.

#### Before You Begin

1. Connect your A/V devices to the TV and connect your A/V receiver to the audio outputs on the TV and the DVD player. Note the name of the device connected to each A/V receiver input. See initial setup, page 10, and "TV Connections," page 14.
2. Position NetCommand IR emitters as described in "IR Emitter Placement," page 46.
3. Set the TV's remote control to **TV** mode using the side button.
4. Open the **Inputs > AVR** menu, highlight **NEXT** and press **ENTER** to display the device-key-learning menu.

#### Case 1: Automatic A/V Receiver Switching to the TV Audio Input

Most devices are set up to use the TV's audio output like the VCR in this example; analog audio from the device is sent through the TV to the A/V receiver's TV audio input.

Use this setup for:

- **Audio Available from TV only.** Send audio from the **ANT** input to the A/V receiver from the TV's analog or digital audio output.

Use this setup to make the A/V receiver switch to its designated TV audio input when viewing programming from the **ANT** input.

- **Analog Stereo Audio.** Audio from sources with only analog stereo output (such as a VCR) can be sent either directly to the A/V receiver or through the TV first. Mitsubishi recommends you send audio through the TV as shown in the example. The TV converts analog audio to digital format to send to a digital A/V receiver.
- **HDMI Digital Stereo Audio.** Digital stereo audio from an HDMI connection is available both in digital and analog format from the TV's analog and digital audio output jacks.

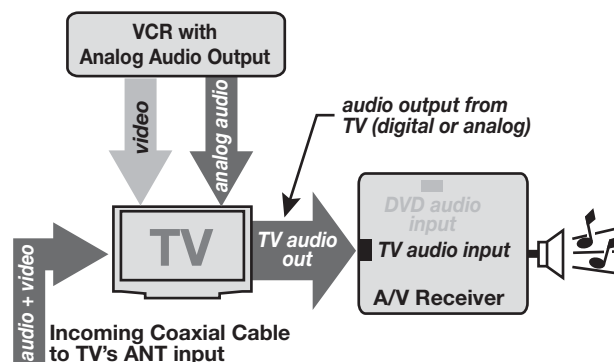

**Important:** To use this setup, you must connect the TV's audio output to the A/V receiver's TV audio input jack.

1. In the **Inputs > AVR** menu, press **▲ ▼** to highlight **TV audio out** as the A/V receiver input to control.
2. Press **ENTER** on the **TV's** remote control.
3. While the text **TV audio out** is flashing, press and hold the **TV INPUT** key on the **A/V receiver's** remote control.
4. When a check appears next to **TV audio out**, release the **TV INPUT** key.
  - If the text stops flashing before the check mark appears, repeat this step.
  - To erase the IR code just "learned," press **CANCEL** while the name is highlighted.
5. Press **MENU** if finished or continue with Case 2 setup for another audio source.

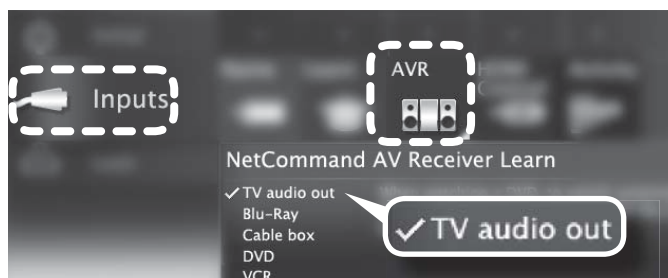

**Case 1:** NetCommand setup for controlling A/V receiver switching to the A/V receiver's audio input from the TV. The list displayed represents inputs in use. The device names are those you assigned during Auto Input Sensing or in the **Inputs > Name** menu..

## Setting Up A/V Receiver Control, continued

### Case 2: Automatic A/V Receiver Switching to a Surround Sound Device

**Note:** Use this setup to send digital surround sound from a device directly to your sound system.

A device can send digital surround sound such as Dolby Digital or DTS directly to the A/V receiver. The device might be a DVD player, cable box, or satellite receiver, and could have HDMI output. A DVD player is used in this example.

Your setup may include additional devices with digital surround sound connected directly to the A/V receiver. These devices might be a DVD player plus a cable box or satellite receiver.

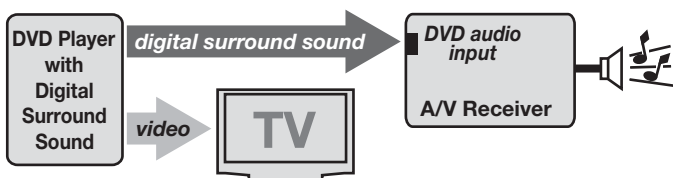

**Case 2:** A/V receiver audio from a device providing surround sound directly to the A/V receiver

1. In the **Inputs > AVR** menu, press **▲ ▼** to highlight the name of the A/V receiver input to control. In this example, it is the **DVD** input.
2. Press **ENTER** on the **TV's** remote control.

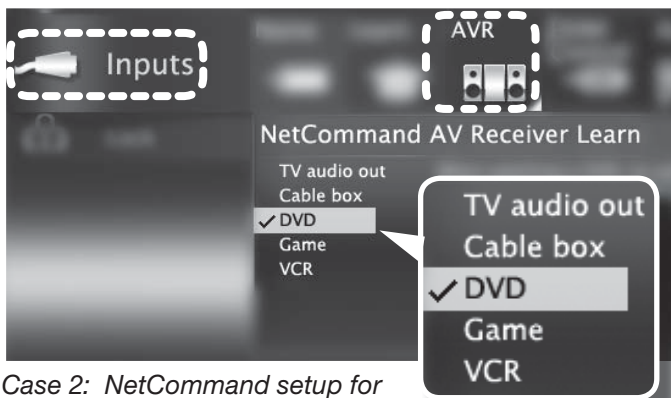

**Case 2:** NetCommand setup for controlling A/V receiver switching to the A/V receiver's DVD input. The list contains connected inputs with names assigned during Auto Input Sensing.

3. While the text **DVD** is flashing, press and hold the **DVD INPUT** key on the **A/V receiver's** remote control.
4. When a check appears next to **DVD**, release the **DVD INPUT** key.
  - If the text stops flashing before the check mark appears, repeat this step.
  - To erase the IR code just "learned," press **CANCEL** while the name is highlighted.

5. If finished, highlight **EXIT** and press **ENTER** or continue to set up additional A/V receiver audio sources.

### Case 3: Automatic Audio and Video Switching via HDMI

If your A/V receiver has an HDMI output, it may be convenient to route video signals from multiple devices over a single cable to the TV. Use this procedure to set up NetCommand control of the A/V receiver's audio and video switching over a single HDMI cable. The connected source devices can be analog, digital, or a mixture or the two. When this setup is complete, you can use the TV's **Activity** menu to select a video device connected to the A/V receiver.

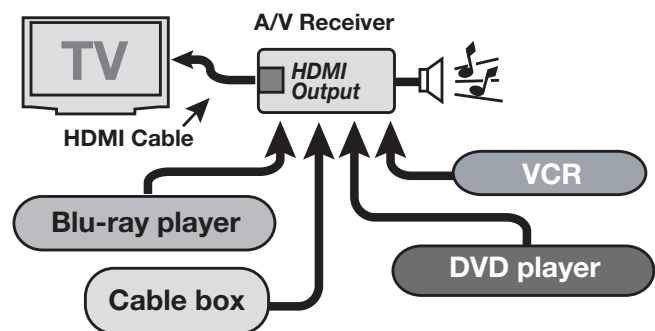

### More About Using an HDMI Connection

- Audio from devices connected directly to the TV can be heard from the TV speakers only. To send audio to the A/V receiver from such devices, use one of the optional audio connections shown in the diagram on the opposite page. For example, use an optional audio connection if you wish to use the A/V receiver speakers to hear audio from:
  - The **ANT** input
  - A game or camcorder connected to the convenience input (**INPUT 3**).
- In some circumstances, audio from a device connected to the A/V receiver may not be passed over the HDMI cable to the TV speakers. In these cases you must use the A/V receiver speakers to hear audio.

### Before You Begin

To complete these steps you will need:

- The remote controls for both the TV and the A/V receiver.
- An IR emitter cable available from Mitsubishi.
- An HDMI-to-HDMI cable to connect the A/V receiver to the TV and cables necessary to connect devices to the A/V receiver.

## Setting Up A/V Receiver Control, continued

1. Connect your audio/video devices to the A/V receiver. Note the name of the device connected to each A/V receiver input. This information will be needed later to set up NetCommand's automatic input switching.
2. Connect the A/V receiver to the TV with an HDMI-to-HDMI cable.
3. Connect the IR emitter cable to the TV and position the IR emitter where it can send signals to the A/V receiver. See "IR Emitter Placement," page 46.
6. Perform the procedure in "Case 2: Automatic A/V Receiver Switching to a Surround Sound Device" on the opposite page.

### Setup to Control Automatic Audio and Video Switching via HDMI

1. Power on the A/V receiver.
2. Set the **TV's** remote control to **TV** mode using the side button.
3. Power on the TV.
4. When the **New Device Found** screen displays, select device name **AVR** if it is not recognized automatically.
5. Navigate to the **Inputs > AVR** menu or, from within the **New Device Found** screen, highlight **NetCommand** and press **ENTER**.

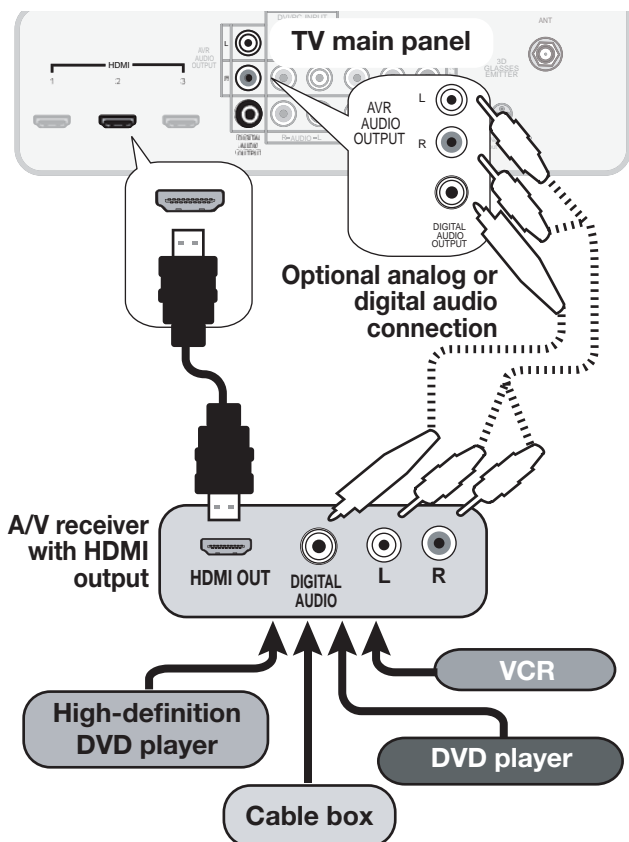

Multiple video inputs through a single HDMI cable. You can connect multiple video devices to an A/V receiver that has an HDMI output. The optional audio connection allows you to hear, through the A/V receiver, devices connected to the TV only, e.g., an antenna on the **ANT** input.

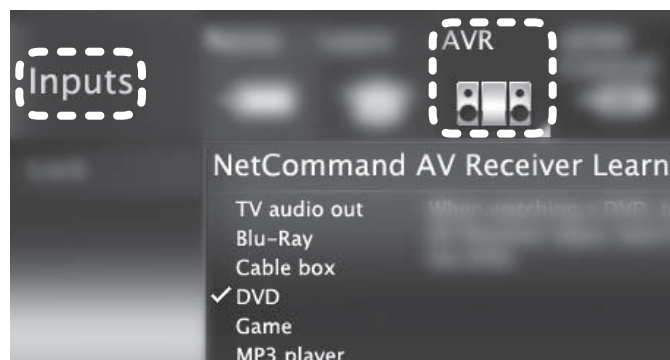

To set up A/V switching over HDMI, choose your devices from a list. Unlike the device list described for Case 2, this generic list contains more than just the devices detected in your setup.

### NetCommand Control of a Device Connected to an HDMI A/V Receiver

Use this setup to have NetCommand control a device sending audio and video through the A/V receiver to the TV via HDMI.

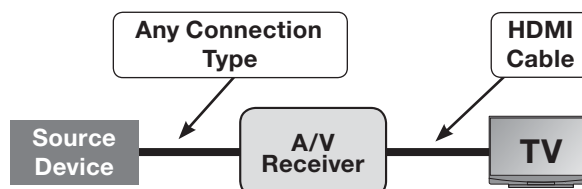

The A/V receiver's remote control key for the input must have been "learned" previously using "Setup to Control Automatic Audio and Video Switching via HDMI" on this page.

1. Set up NetCommand control of A/V receiver audio/video switching via HDMI as described on this page.
2. Press **BACK** to close any open menus and return to normal TV viewing.
3. Press **ACTIVITY**.
4. Highlight the icon for the A/V receiver input you wish to control.
5. Press **ENTER** to switch the TV to the A/V receiver and the A/V receiver to the device.
6. Open the **Inputs > Learn** menu.
7. Perform NetCommand "learning" for the device by following the steps in "Initial NetCommand Setup," page 47.

# Appendices

---

<b>Appendix A: Bypassing the Parental Lock . . . . .</b>	<b>57</b>
<b>Appendix B: Programming the Remote Control . . . . .</b>	<b>59</b>
<b>Appendix C: HDMI Control of CEC Devices . . . . .</b>	<b>66</b>
<b>Appendix D: TV Care . . . . .</b>	<b>69</b>
<b>Appendix E: Troubleshooting . . . . .</b>	<b>72</b>



## Appendix A: Bypassing the Parental Lock

# Lock Bypass Instructions Have Been Filed for Future Reference

### IMPORTANT

Cut along the dotted line and file bypass instructions in a safe place for future reference.

## Mitsubishi DLP Projection TV

C9 Series  
737 Series  
837 Series

### Bypassing the Parental Lock

After you set the lock, you must use your pass code to:

- View a locked program
- View the locked TV
- Cancel the lock
- Enter the **Lock** menus

If you forget your pass code, you can view the locked TV without entering your pass code. When prompted for the pass code, press the number **9** and  (**LAST**) keys on the TV remote control at the same time. This process temporarily unlocks the TV.

When entering the **Lock** menu, you are prompted to enter a pass code.

- To change the pass code, press **9** and  (**LAST**) at the same time. Either enter a new pass code to open the **Lock** menu and make changes or press **BACK** to close the menu.
- If any of the locks are turned on and you exit the menus when prompted for a new code, the old code and all lock settings are retained.
- If all locks are turned off and you exit the menus when prompted for a new code, then the previous code is erased.

### IMPORTANT

When changing or deleting your pass code, you must use the remote control included with this TV. You cannot use a Mitsubishi remote control from another component or a “universal” remote.

*This page intentionally left blank*

## Appendix B: Programming the Remote Control

This appendix explains programming the TV's remote control to operate other A/V devices. This is distinct from NetCommand control.

### Functions Available for Other A/V Devices

The TV's remote control can be programmed to operate other types and brands of A/V products. The functions performed in each switch position vary depending on the product. Not all functions work for all models. The most common functions available are listed on this page.

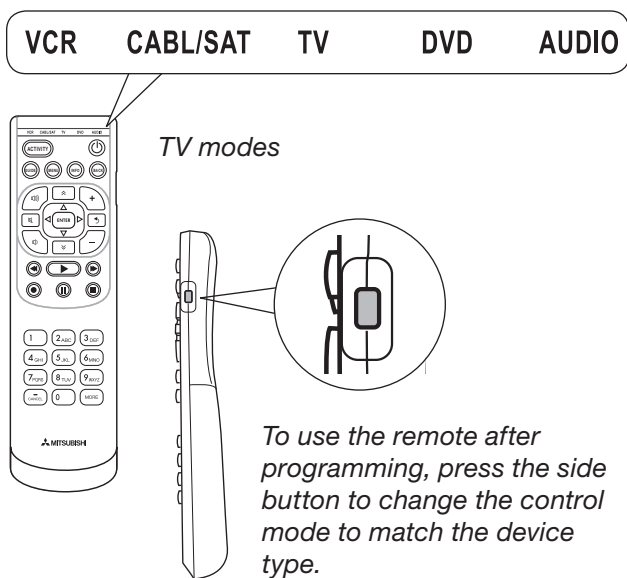

### The MORE Menu

The MORE key displays a menu showing additional key functions available for a device type after programming the remote control.

#### IMPORTANT

Some manufacturers may change their products or they may use more than one remote control system. The TV's remote control may be unable to operate your A/V equipment in these cases.

#### VCRs and DVRs

- |   |   |
|---|---|
| <ul style="list-style-type: none"> <li>• CHANNEL UP/DN</li> <li>• POWER</li> <li>• SLEEP (from MORE menu)</li> <li>• ►► (FAST FORWARD)</li> <li>•    (PAUSE)</li> <li>• ► (PLAY)</li> </ul> | <ul style="list-style-type: none"> <li>• ● (RECORD)</li> <li>• ◀◀ (REVERSE)</li> <li>• ■ (STOP)</li> <li>• GUIDE (DVR only)</li> <li>• MENU (DVR only)</li> <li>• 0-9 Number Buttons</li> </ul> |
|---|---|

Mitsubishi VCRs are compatible with some additional keys.

#### Cable Boxes and Satellite Receivers

(not all functions for all models)

- |  |  |
|--|--|
| <ul style="list-style-type: none"> <li>• PAGE UP/DOWN</li> <li>• CANCEL</li> <li>• CHANNEL UP/DN</li> <li>• ENTER</li> <li>• GUIDE</li> <li>• POWER</li> <li>• ▲▼◀▶</li> <li>• LAST (ENTER; for channels on some models)</li> <li>• 0-9 Number Keys</li> </ul> | <p>The record/playback keys:</p> <ul style="list-style-type: none"> <li>• ►► (FAST FORWARD)</li> <li>•    (PAUSE)</li> <li>• ► (PLAY)</li> <li>• ● (RECORD)</li> <li>• ◀◀ (REVERSE)</li> <li>• ■ (STOP)</li> </ul> |
|--|--|

#### A/V Receivers

- |   |  |
|---|--|
| <ul style="list-style-type: none"> <li>• MUTE</li> <li>• POWER</li> <li>• SLEEP (from MORE menu)</li> <li>• VOLUME</li> <li>• 0-9 Number Buttons</li> </ul> | <ul style="list-style-type: none"> <li>• Direct Input Selection buttons: numbers and LAST (on some Mitsubishi models)</li> </ul> |
|---|--|

#### CD Players

(not all functions for all models)

- |   |  |
|---|--|
| <ul style="list-style-type: none"> <li>• SLEEP (from MORE menu)</li> <li>• ►► (FAST FORWARD)</li> <li>•    (PAUSE)</li> <li>• ► (PLAY)</li> </ul> | <ul style="list-style-type: none"> <li>• ◀◀ (REVERSE)</li> <li>• ■ (STOP)</li> <li>• 0-9 Number Buttons</li> </ul> |
|---|--|

#### DVD Players

(not all functions for all models)



- |  |  |
|--|--|
| <ul style="list-style-type: none"> <li>• CANCEL (on some models)</li> <li>• CHANNEL UP/DN (for track skip on some models)</li> <li>• ENTER</li> <li>• MENU</li> <li>• POWER</li> <li>• SLEEP (from MORE menu)</li> <li>• ▲▼◀▶</li> </ul> | <ul style="list-style-type: none"> <li>• ►► (FAST FORWARD)</li> <li>•    (PAUSE)</li> <li>• ► (PLAY)</li> <li>• ● (RECORD)</li> <li>• ◀◀ (REVERSE)</li> <li>• ■ (STOP)</li> <li>• 0-9 Number Keys</li> </ul> |
|--|--|

## Appendix B: Programming the Remote Control, continued

### Programming the Remote Control

1. Press the side button on the remote control to change to the correct mode for the product you want to control. Refer to the table below. Only one of each device type can be controlled in each mode.

Mode	Affected Device
CABLE/SAT	Cable Box DTV Receiver Satellite Receiver
VCR	VCR DVR DVD Player/Recorder
DVD	DVD Player/Recorder DVR VCR
AUDIO	A/V Receiver Audio Amplifier CD Player

2. Press and hold **POWER** on the remote control for several seconds until the mode indicator blinks twice and goes off.
3. Release the **POWER** key.
4. Enter the first five-digit code listed for your equipment.
  - The mode indicator blinks twice when you start to enter the code and then once for each additional keypress.
  - The mode indicator blinks twice when you finish entering a valid code.
  - If you need to start over or wish to exit programming mode, temporarily change to a different mode using the side button.
5. Point the remote control at the equipment and press **POWER**. If the product has no power on/off function, press a different key, such as  (**PLAY**),  (**STOP**), **VOLUME UP**, or **MUTE**.
  - If the equipment responds, the remote control is properly programmed.
  - If the equipment does not respond, repeat steps 2–4 with the next five-digit code listed for your equipment.
6. Once you have found the correct code, write it in the space below for future reference.

Mode	Device Type	Code
CABLE/SAT		
VCR		
DVD		
AUDIO		

#### **IMPORTANT**

You may need to reprogram the remote control after changing the batteries. Record the codes for each mode in the space provided to make this faster.

#### **Code Verification**

To determine the code programmed for any mode:

1. Set the mode to the one you wish to verify.
2. Press and hold **POWER** on the remote control for several seconds until the mode indicator blinks twice and goes off.
3. Press keys **9 9 0**
4. Press **1** and count the blinks of the power key. Write down the number of blinks as the first digit of the code.
5. Repeat step 4 for the second, third, fourth, and fifth digits of the code.

### Audio Lock: Universal A/V Receiver Control

With Audio Lock enabled, the remote control operates volume and mute on the A/V receiver in all modes set by the side button. Activate Audio Lock if you normally use an A/V receiver with your TV and other A/V equipment.

1. Program **AUDIO** mode for your A/V receiver as described in “Programming the Remote Control” on this page.
2. With the remote control in **AUDIO** mode, hold **POWER** on the remote control for several seconds until the mode indicator blinks twice and goes off.
3. Press keys **9 9 3 ENTER**  
The mode indicator will blink twice to indicate Audio Lock is active.

#### **To Reset the Remote Control to Operate Volume and Mute for the TV Speakers**

1. Press and hold **POWER** for several seconds until the mode indicator blinks twice and goes off.
2. Press keys **9 9 3 VOLUME UP**.  
The mode indicator will blink four times to indicate Audio Lock has cleared.

## Appendix B: Programming the Remote Control, continued

### Programming Codes

#### Audio Amplifiers

Adcom	41100, 40577
Altec Lansing	41742
Bel Canto	41583
Design	
Bose	40674
Carver	40892
Cary Audio	41879
Design	
Classe	41461
Flextronics	41879
Halcro	41934
Harman/	40892
Kardon	
JVC	40331
Krell	41837
Left Coast	40892
Lexicon	41802, 41145
Marantz	40892
Mark	41483
Levinson	
Parasound	41934
Philips	40892
Polk Audio	40892
Victor	40331
Yamaha	40354

#### Cable Boxes

A-Mark	10144, 10008
ABC	10237, 10008
Acorn	10237
Action	10237
Active	10237
Americast	10899
Amino	11822, 11602
Archer	10237
Bell South	10899
Century	10008
Cisco	11982, 11877, 10877
Comcast	11982
Digeo	12187
Director	10476
GE	10144
General	10476
Instrument	
GoldStar	10144
Hitachi	10008
i3 Micro	11602
Insight	10476
Jerrold	10476
Memorex	10000
Motorola	11376, 11254, 10476
Myrio	11822, 11602
Nova Vision	10008
Novaplex	10008
Pace	11877, 10877, 10237, 10008
Panasonic	11982, 10144, 10008, 10000

#### Cable Boxes

Paragon	10525, 10008, 10000
Penney	10000
Philips	11305
Pioneer	11877, 10877, 10533, 10144
Pulsar	10000
Quasar	10000
Runco	10000
Samsung	10144
Scientific	11877, 10877, 10477,
Atlanta	10237, 10008, 10000
Sejin	11602
Sony	11006
Sprucer	10144
Toshiba	10000
US Elec- tronics	10008
Videoway	10000
Zenith	10899, 10525, 10000

#### CD Players

Acoustic	40420
Research	
Akai	40083
Burmester	40420
California	40029
Audio Labs	
DKK	40000
Fisher	40000
Garrard	40420
Hafner	40173
Harman/	41202, 40173, 40100,
Kardon	40083
Inkel	40180
Integra	40101
JVC	41294, 40072
Kenwood	40626, 40190, 40037, 40029, 40000
KLH	41711, 41318
Koss	41317
LG	41208
Magnavox	40038
Marantz	40626, 40435, 40180, 40038, 40029
McIntosh	41703
MCS	40029
Memorex	40420, 40000
MGA	40083
Miro	40000
Mitsubishi	40098, 40083
Modulaire	40420, 40180, 40087, 40000
MTC	40420
NAD	41208
Onkyo	41327, 40101
Optimus	40420, 40087, 40037, 40000
Panasonic	40752, 40388, 40029

#### CD Players

Parasound	40420
Penney	40029
Philips	40626
Pioneer	41087
Proceed	40420
Quasar	40029
RadioShack	40420, 40180, 40000
RCA	40420
Realistic	40420, 40180, 40087, 40000
Roksan	40435
Rotel	40420
Sansui	40000
Sanyo	40087, 40000
Sharp	40180, 40037
Sherwood	41950, 40180
Sony	41364, 40490, 40185, 40100, 40000
Symphonic	40180
Tascam	40420
TDK	41208
Teac	40490, 40420, 40180
Technics	40029
Victor	40072
Wards	40087
Yamaha	41292, 40490, 40036
Yorx	40000

#### A/V Receivers

ADC	40531
Aiwa	41641, 41405, 41388, 41243, 40189, 40121
Alco	41390
AMC	41077
Anam	41609, 41074
Arcam	41189
Audiotronic	41189
Audiovox	41390
Bose	41933, 41841, 41629, 41253, 41229, 40639
Cairn	40189
Capetronic	40531
Carver	41289, 41189, 40189, 40121
Curtis	40014
Mathes	
Daewoo	41250
Denon	41360, 41306, 41142, 40121
Emerson	40531
Fisher	41801
Grundig	40189
Harman/	41306, 41304, 41289,
Kardon	40891, 40189, 40110
Hitachi	41801
Insignia	42169, 41893, 41077, 41030

## Appendix B: Programming the Remote Control, continued

### Programming Codes, continued

A/V Receivers		A/V Receivers		Satellite Receivers	
Integra	41805, 41320, 41298, 40842	Technics	41518, 41308	SKY	10099
JBL	41306, 40110	Thorens	41189	Sony	11640, 11639, 10639
JVC	42331, 41643, 41495, 41374, 41282, 41058	Toshiba	41788, 41123, 40842	Thomson	10566, 10392
Kawasaki	41390	Venturer	41390	Tivo	11442, 11142
Kenwood	41570, 41569, 41313	Wards	40189, 40014	Toshiba	11749, 10790, 10749
KLH	41428, 41390	Yamaha	41815, 41476, 41376, 41375, 41331, 41276, 41176, 41023, 40176	UltimateTV	11640, 11392
LG	42197, 41293	YBA	41921	Uniden	10722
Linn	40189	Zenith	41293	Zenith	11856, 11810
Magnavox	41514, 41269, 41266, 41189, 40531, 40189	Satellite Receivers		VCRs	
Marantz	41289, 41269, 41189, 40891, 40189	Bell ExpressVu	11170, 10775	A-Mark	20278, 20046, 20037, 20000
McIntosh	41289	Chaparral	10216	ABS	21972
Micromega	41189, 40189	Crossdigital	11109	Accurian	20000
Mitsubishi	41957, 41922, 41921, 41920, 41393	DirecTV	11856, 11749, 11640, 11639, 11609, 11442, 11414, 11392, 11377, 11142, 11109, 10819, 10749, 10639, 10566, 10392, 10247, 10099	Admiral	20479, 20209, 20060, 20048, 20047, 20039
Myryad	41189	Dish	11775, 11505, 11170, 10775	Adventura	20037, 20000
Nakamichi	41313	Network System	10775	Aiko	20278
Onkyo	41905, 41805, 41320, 41298, 40842	Dishpro	11775, 11505, 10775	Aiwa	20124, 20037, 20000
Optimus	41074, 41023, 40531, 40121, 40014	Echostar	11775, 11505, 11170, 10775	Akai	20242, 20175
Panasonic	42967, 41764, 41763, 41633, 41548, 41518, 41509, 41316, 41308, 41288, 41275	Expressvu	11775, 10775	Alba	20278, 20209
Philips	41269, 41266, 41189, 40891, 40531, 40189	Fortec Star	11821	Alienware	21972
Pioneer	41935, 41384, 41123, 41023, 40630, 40531, 40150, 40014	Funai	11377	Allegro	20039
Polaroid	41508	GE	10566	America	20278
Polk Audio	41289, 40189	GOI	11775, 10775	Action	
Proscan	41254	Hitachi	11250, 10819, 10749	American	20081, 20035
RadioShack	41609	Houston	10775	High	
RCA	41609, 41511, 41390, 41254, 41123, 41074, 41023, 40531	HTS	11775, 10775	Amstrad	20000
Realistic	41609, 40121	Hughes	11749, 11442, 11142, 10749	Astra	20035
Revox	40189	Network Systems		Audiovox	20278, 20038, 20037
Rio	41869	Humax	11790, 11781	Avis	20000
Samsung	41500, 41304, 41295	Innova	10099	Bell &	20479, 20048, 20046, 20039, 20035, 20000
Sansui	41189, 40189	JVC	11775, 11170, 10775	Howell	20039, 20035, 20000
Sanyo	41801	LG	11414	Bell	21944
Sherwood	42169, 41905, 41077	Magnavox	10722	ExpressVu	
Sherwood	42169	Mitsubishi	10749	Broksonic	20479, 20209, 20184, 20121
Newcastle		Netsat	10099	Calix	20037
Sonic Blue	41869	Panasonic	10701, 10247	Candle	20038, 20037
Sony	41858, 41822, 41759, 41758, 41658, 41622, 41558, 41441, 41382, 41258, 41131, 41058	Pansat	11807	Canon	20035
Stereophonics	41023	Philips	11749, 11442, 11142, 10775, 10749, 10722, 10099	Carver	20081, 20035
Sunfire	41313	Proscan	10566, 10392	CCE	20278
Teac	41390, 41074	RadioShack	10775, 10566	Cineral	20278
		RCA	11442, 11392, 11142, 10855, 10775, 10566, 10392, 10143	Citizen	20479, 20278, 20209, 20037, 20035, 20000
		Samsung	11609, 11442, 11377, 11276, 11142, 11109	Classic	20037
				Colortyme	20278, 20060, 20045, 20035
				Colt	20000
				Craig	20047, 20037
				Criterion	20000
				Crosley	20081, 20035, 20000
				Crown	20278
				Curtis	20432, 20278, 20162, 20060, 20035, 20000
				CyberPower	21972
				Daewoo	20278, 20046, 20045, 20037

## Appendix B: Programming the Remote Control, continued

### Programming Codes, continued

VCRs		VCRs		VCRs	
Daytron	20278, 20037	HTS	21944	Nikkodo	20278, 20037
Dell	21972	Hughes	20739, 20042	Niveus	21972
Denon	20081, 20042	Network		Media	
DirecTV	20739	Systems		Northgate	21972
Dish	21944	Humax	21988, 21797, 20739	Olympus	20162, 20035
Network		Hush	21972	Onkyo	20222
System		Hytek	20047, 20000	Optimus	21062, 21048, 20593, 20432, 20162, 20048, 20047, 20037, 20035, 20000
Dishpro	21944	iBUYPOWER	21972	Orion	20479, 20278, 20209, 20184, 20121, 20000
Dual	20000	Instant	20035	Panama	20035
Durabrand	20039, 20038	Replay		Panasonic	21062, 20616, 20614, 20225, 20162, 20035, 20000
Dynatech	20000	Jensen	20067	Penney	20162, 20081, 20067, 20047, 20042, 20038, 20037, 20035, 20000
Echostar	21944	JVC	21944, 20067	Pentax	20042
Electrohome	20209, 20060, 20043, 20037, 20000	KEC	20278, 20037	Philco	20479, 20209, 20081, 20035, 20000
Electrohome	20037	Kenwood	20067, 20046, 20038	Philips	21181, 21081, 20739, 20618, 20616, 20209, 20162, 20081, 20048, 20045, 20035, 20000
Emerald	20184, 20121	Kodak	20037, 20035	Pilot	20037
Emerex	20032	KTV	20000	Pioneer	20162, 20081, 20067, 20042
Emerson	21593, 20593, 20479, 20278, 20209, 20184, 20121, 20043, 20037, 20000	LG	20038, 20037	Polk Audio	20081
Expressvu	21944	Linksys	21972	Portland	20278
Fisher	20047, 20046, 20039, 20000	Lloyd's	20038, 20000	Presidian	21593
Fuji	20035, 20033	Loewe	20081	Proscan	20060
Fujitsu	20000	Logik	20000	Protec	20000
Funai	21593, 20593, 20278, 20037, 20000	Lumatron	20278	Pulsar	20278, 20039
Garrard	20000	Luxor	20046	Quarter	20046
Gateway	21972	LXI	20067, 20042, 20037, 20000	Quartz	20047, 20046, 20035
GE	20060, 20048, 20035, 20000	Magnasonic	20593, 20278, 20037, 20000	Quasar	20162, 20035
Gemini	20060	Magnavox	21593, 20618, 20593, 20563, 20081, 20048, 20039, 20037, 20035, 20000	RadioShack	20162, 20048, 20047, 20046, 20037, 20035, 20000
Genexxa	20278, 20037, 20000	Marantz	20081, 20038, 20035	Radix	20037
GFM	21593	Marta	20037	Randex	20037
Go Video	20614, 20432	Matsui	20209, 20037	RCA	20880, 20060, 20048, 20045, 20042, 20035, 20000
GOI	21944	Matsushita	20162, 20081, 20035	Realistic	20278, 20162, 20121, 20048, 20047, 20046, 20037, 20035, 20000
GoldStar	20278, 20039, 20038, 20037, 20035, 20000	Media	21972	ReplayTV	20616, 20614
Goodmans	20278, 20081, 20037, 20000	Center PC		Ricavision	21972
Gradiente	20000	MEI	20035	Runco	20039
Granada	20081, 20042	Memorex	20479, 20278, 20209, 20162, 20048, 20047, 20046, 20039, 20037, 20035, 20000	Salora	20075
Grundig	20081	Metz	20037	Samsung	20739, 20432, 20060, 20045, 20038, 20000
Harley	20000	MGA	20060, 20043	Sanky	20048, 20039
Davidson		Microsoft	21972		
Harman/ Kardon	20081, 20075, 20038	Mind	21972		
Headquarter	20046	Minolta	20042		
Hewlett Packard	21972	Mitsubishi	20443, 20242, 20214, 20173, 20075, 20067, 20060, 20048, 20047, 20043, 20042, 20000		
HI-Q	20047, 20035, 20000	Motorola	20048, 20035		
Hitachi	20089, 20045, 20042, 20037, 20035, 20000	MTC	20000		
Howard Computers	21972	MTX	20000		
HP	21972	Multitech	20039, 20000		
		NEC	20067, 20038		
		Nikko	20278, 20037		

## Appendix B: Programming the Remote Control, continued

### Programming Codes, continued

VCRs		VCRs		DVD and Blu-ray Players	
Sansui	20479, 20209, 20067, 20000	Touch	21972	B & K	30662, 30655
Sanyo	20479, 20159, 20047, 20046, 20000	Trix	20037	BBK	31224
Scott	20184, 20121, 20045, 20043	Ultra	20278, 20045	Bel Canto	31571
Sears	20209, 20162, 20067, 20060, 20048, 20047, 20046, 20045, 20043, 20042, 20039, 20037, 20035, 20033, 20000	Vector	20045	Design	
Sharp	20848, 20048, 20047, 20032, 20000	Vector	20184, 20038	Blaupunkt	30717
Shintom	20039, 20000	Research		Blue Parade	30571
Siemens	20037	Victor	20067	Blue Sky	30699, 30695
Signature	20479, 20060, 20048, 20046, 20037, 20035, 20000	Video Concepts	20242, 20045	Bose	32023, 31895
Singer	20037	Videomagic	20037	Brandt	30651
Sonic Blue	20616, 20614	Videosonic	20000	Broksonic	30695
Sonographe	20046	Viewsonic	21972	California	30490
Sony	21972, 21032, 20636, 20067, 20047, 20046, 20035, 20033, 20032, 20000	Villain	20000	Audio Labs	
Soundmaster	20000	Voodoo	21972	Celestial	31020
Stack 9	21972	Wards	20479, 20081, 20060, 20048, 20047, 20046, 20045, 20043, 20042, 20038, 20037, 20035, 20033, 20000	Centrex	31004, 30672
STS	20042	Wharfedale	20593	Cinea	30831
SV2000	20000	White	20479, 20278, 20209, 20000	CineVision	30869, 30833
SVA	20000	Westinghouse	20000	Citizen	32116, 31587, 31277, 31003, 30695
Sylvania	21593, 20593, 20081, 20043, 20035, 20000	World	20479, 20209	Clairtone	30571
Symphonic	21593, 20593, 20000	XR-1000	20035, 20000	Coby	31351, 31177, 31165, 31107, 31086, 31077, 30852, 30778
Systemax	21972	Yamaha	20038	Craig	30831
Tagar	21972	Zenith	21139, 20479, 20278, 20209, 20039, 20037, 20033, 20000	Creative	30539, 30503
Systems		ZT Group	21972	Curtis	31087
Tandy	20000	<b>DVD and Blu-ray Players</b>		Mathes	
Tashiko	20037	3D LAB	30539, 30503	CyberHome	31537, 31502, 31129, 31117, 31024, 31023, 30874, 30816
Tatung	20081, 20067, 20048, 20000	Accurian	31416, 30675	Cytron	30705
Teac	20067, 20000	Acoustic Solutions	30730	Daewoo	31242, 31234, 31172, 31169, 30869, 30833, 30784, 30770, 30705
Technics	20162, 20037, 20035, 20000	Adcom	31094	Dansai	30770
Teknika	20037, 20035, 20000	Afreey	30698	Daytek	30872
Tevion	20479	Aiwa	30641, 30533	Decca	30770
Thomas	20000	Akai	31089, 30770, 30705, 30695	Denon	32258, 30634, 30490
Thomson	20060	Alba	30717, 30672	Denver	30778
Tisonic	20278	Alco	30790	Desay	31407
Tivo	21944, 20739, 20636, 20618	Allegro	30869	DigitalMax	31738
TMK	20000	Amphion	30872	Digitrex	30672
TNIX	20037	Media Works		Disney	31270, 30675
Toshiba	21988, 21972, 21008, 20209, 20045, 20043, 20000	AMW	30872	DiViDo	30705
Tosonic	20278	Apex Digital	31061, 31056, 31020, 31004, 30797, 30796, 30794, 30755, 30717, 30672, 30533	Dual	31068, 30675
Totevision	20037	Arrgo	31023	Durabrand	31127, 31023
		Aspire	31168, 31407	DVD2000	30521
		Digital		Electrohome	32116, 31003
		Astar	31489	Emerson	31268, 30675, 30591
		Audiovox	31041, 30790, 30717	Enterprise	30591
		Awa	30730	Entivo	30539, 30503
				Enzer	30770
				ESA	31268
				Firstline	30651
				Fisher	30670
				Funai	31268, 30675
				Gateway	31158, 31077, 31073
				GE	30815, 30717, 30522



**Appendix B: Programming the Remote Control, continued****Programming Codes, continued****DVD and Blu-ray Players**

GFM	31268, 30675
Go Video	31730, 31304, 31158, 31144, 31099, 31075, 31044, 30869, 30833, 30783, 30744, 30741, 30717, 30715, 30573
GoldStar	30869, 30741
Goodmans	30790
GPX	30769, 30699
Gradiente	30651, 30490
Greenhill	30717
Grundig	30705, 30539
Harman/ Kardon	30702, 30582
Hello Kitty	30831
Hitachi	30664, 30573
Hiteker	30672
Humax	31588, 31500
iLo	31348
Initial	30717
Insignia	32095, 31268, 30675
Integra	31769, 30627, 30571
IRT	30783
JBL	30702
JMB	30695
JSI	31423
JVC	31550, 31275, 31164, 30867, 30623, 30558
jWin	31049
Kawasaki	30790
Kenwood	30534, 30490
KLH	31149, 31020, 30790, 30717
Kloss	30533
Koss	31423, 31061, 30769, 30651
Lasonic	30798, 30627
Lecson	31533
Lenoxx	31127
LG	30869, 30741, 30591
LiteOn	31738, 31656, 31440, 31416, 31158, 31058
Loewe	30741, 30511
Logix	30783
Magnasonic	30675, 30651
Magnavox	31506, 31354, 31268, 30675, 30646, 30539, 30503
Marantz	30675, 30539, 30503
McIntosh	31533, 31273
Medion	30651
Memorex	31270, 30831, 30695
Microsoft	32083, 30522
Minato	30752
Mintek	30839, 30717
Mitsubishi	31521, 30521
Mustek	30730

**DVD and Blu-ray Players**

Myryad	30894
NAD	30741
Naiko	30770
NEC	30869, 30785
Nesa	30717
NexxTech	31402
Norcent	31265, 31107, 31003, 30872
Onkyo	31769, 30627, 30503
Oppo	31224, 30575
Optimus	30571
Oritron	30651
Palsonic	30852, 30672
Panasonic	31762, 31641, 30703, 30632, 30571, 30503, 30490
Philco	30675
Philips	32084, 32056, 31506, 31354, 31340, 31267, 31158, 30675, 30646, 30539, 30503
Phonotrend	30699
PianoDisc	31024
Pioneer	31571, 31512, 31460, 30632, 30631, 30571, 30525, 30142
Polaroid	31086, 31061, 31020
Polk Audio	30539
Portland	30770
Presidian	31738, 30675
Proceed	30672
Proscan	30522
Prosonic	30699
ProVision	30778
Qwestar	30651
Radionette	30741
RadioShack	30571
RCA	31769, 30822, 30790, 30717, 30571, 30522
Realistic	30571
Reoc	30752
Revoy	30699
Rio	30869
Rotel	31178, 30623
Rowa	31004
Saba	30651
Sampo	30752, 30698
Samsung	31075, 31044, 30820, 30744, 30573, 30490, 30199
Sansui	30695
Sanyo	30873, 30695, 30675, 30670
Schneider	30783
Schwaiger	30752
Sensory	31158
Science	

**DVD and Blu-ray Players**

Sharp	32250, 31256, 30752, 30675, 30630
Sharper	31117
Image	
Sherwood	31077, 31043, 30770, 30633
Sherwood	31077
Newcastle	
Shinsonic	30839, 30533
Slim Art	30784
SM Elec- tronic	30730
Sonic Blue	31099, 30869, 30783, 30715, 30573
Sony	31536, 31533, 31516, 31431, 31070, 31033, 30864, 30533
Sungale	31074
SVA	30860, 30717
Sylvania	31268, 30675
Symphonic	31268, 30675
TAG	30894
McLaren	
Tatung	30770
Teac	30790, 30717, 30571
Technics	30703, 30490
Technika	30770
Technosonic	30730
Tevion	30651
Theta Digital	30571
Thomson	30522, 30511
Tivo	31588, 31512, 31503
Toshiba	31769, 31608, 31588, 31515, 31510, 31503, 31154, 30695, 30573, 30539, 30503
Tredex	30800
Unimax	30770
United	30730
Universum	30591
Urban Con- cepts	30539, 30503
US Logic	30839
V	31226, 31064
Venturer	30790
Vizio	31226, 31064
Wesder	30699
Xbox	32083, 30522
Yamaha	30646, 30545, 30539, 30497, 30490
Yamakawa	30872
Zenith	30869, 30741, 30591, 30503
Zeus	30784
Zoece	31265

## Appendix C: HDMI Control of CEC Devices

Many new HDMI devices have a feature called Consumer Electronics Control (CEC) or HDMI Control. HDMI Control allows one device, such as the TV, to control other devices, such as an A/V receiver or disc player. Use of CEC is optional.

Each manufacturer chooses which CEC functions to support so it is difficult to predict which devices and features are compatible with Mitsubishi's HDMI Control. You may find that CEC functions for a specific device are limited.

### To use HDMI Control, you must enable it in both the TV and the device.

- **In the TV.** Enable HDMI control from the **New Device Found** screen or from the **Inputs > HDMI Control** menu.
- **In the Device.** Most devices with HDMI CEC compatibility let you turn it on or off in the device menus, where it is typically listed as "HDMI Control."

### Enabling HDMI Control of CEC Devices

To ensure proper detection

- Power on HDMI devices before connecting them to the TV.
  - Connect and set up HDMI devices one at a time.
1. Power on the device and allow it to complete the power-on sequence (boot up). Stop any playback.
  2. Connect the device to one of the TV's HDMI inputs.
  3. When the TV detects the connection, the **New Device Found** screen will appear.

**Note:** See "If the New Device Found Screen Displays No HDMI Control Option" on this page if there is no HDMI Control option.



*New Device Found screen with HDMI Control option. This screen displays only if the device's HDMI Control is enabled.*

4. If prompted for a name, highlight the name you want to assign the device.



5. Highlight **On**.

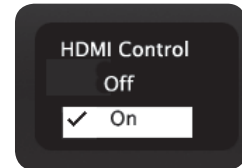

7. Highlight **EXIT** and press **ENTER** to close the **New Device Found** screen.

**Note:** At any time after completing Auto Input Sensing, you can set the TV's HDMI control on or off in the **Inputs > HDMI Control** menu.

### If the New Device Found Screen Displays No HDMI Control Option

If the **New Device Found** screen shows no option for HDMI Control, one of these conditions applies:

- **HDMI Control is turned off in the menus of the new device**  
**Action:**
  - a. Highlight **EXIT** and press **ENTER** to close the **New Device Found** screen.
  - b. Display the device's setup menus and enable the device's CEC capabilities.
  - c. Wait for the TV's **New Device Found** screen to appear again.
  - d. If the **New Device Found** screen still has no HDMI Control option, power off the device. Power on the device and wait for the **New Device Found** screen to display with the HDMI Control option.
- **The device does not have CEC compatibility**  
**Action:**
  - Control the device with its own remote control or program the TV's remote control to operate the device.
  - **837 Series.** Use the TV's NetCommand IR control (page 45).

## HDMI Control of an HDMI A/V Receiver and Connected Devices

**Note:** Connect the A/V receiver to the TV before connecting any other device to the A/V receiver.

1. Enable HDMI Control for the A/V receiver as described in “Enabling HDMI Control of CEC Devices” on the opposite page.
2. Power on the HDMI device you wish to connect to the A/V receiver (such as a disc player, cable box, or satellite receiver). Allow the device to complete the power-on sequence (boot up). Stop playback if the device starts playing.
3. Connect the device to the A/V receiver with an HDMI cable.
4. Select the device’s HDMI input on the A/V receiver’s front panel controls or remote control.
5. When the TV detects the connection, the **New Device Found** screen will appear.

**Note:** If the TV is unable to detect the device, either the device’s CEC capability is not enabled or the device is not CEC compatible. Enable HDMI control through the device’s menus before continuing. You may need to temporarily connect the device directly to the TV to view device menus.

6. Highlight **On**.

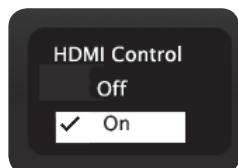

7. Highlight **EXIT** and press **ENTER** to close the **New Device Found** screen.
8. Optional: Connect the TV’s **DIGITAL AUDIO OUTPUT** to an input on the A/V receiver. Use this additional connection if:
  - You want the ability to switch between the A/V receiver speakers and the TV speakers.
  - You want to use the A/V receiver to listen to devices connected to the TV only, e.g., an antenna input or camcorder.
9. **837 Series.** If desired, perform NetCommand IR Learning to supplement CEC functions. You must first connect and place IR emitters for the devices. See page 45.

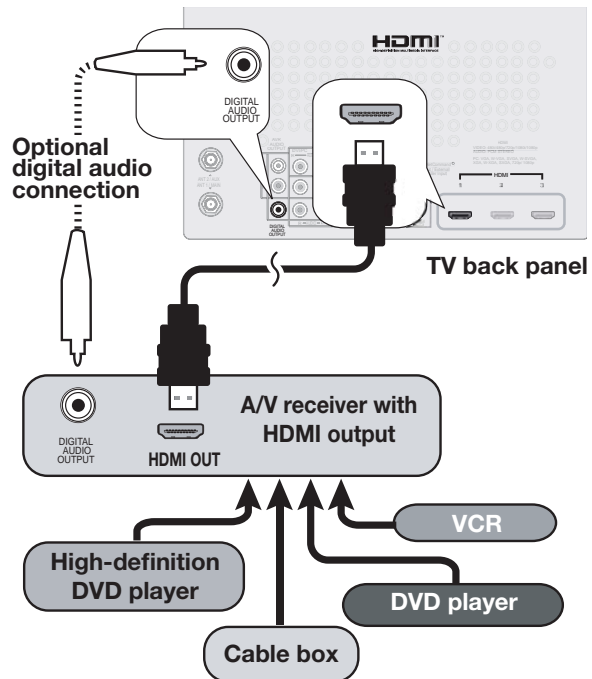

*Connecting HDMI devices. The optional digital audio connection allows you to hear audio through the A/V receiver from devices connected to the TV only.*

## Resolving CEC Conflicts

Because each manufacturer selects which CEC functions to support, some devices can conflict with other devices. If control conflicts arise, you can:

- Turn off TV control of an individual CEC-enabled device (see below).
- Turn off CEC in the setup menu of one of the devices.

### Turning Off the TV's HDMI Control of a CEC Device

1. Press **MENU** on the TV remote control.
2. Highlight **Inputs > HDMI Control** and press **ENTER** to open the menu.
3. Move to the device name and press **▲▼** to select **Off** to turn off the TV's ability to control the device.
4. Press **MENU** to clear the menu.

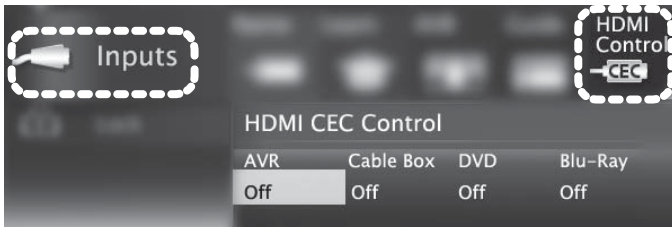

*Inputs > HDMI Control menu*

### Removing an HDMI Device

1. Power off the device.
2. Disconnect the HDMI cable.
3. Press **MENU** on the TV remote control to enter the TV main menu.
4. Highlight **Inputs > Name** and press **ENTER** to open the menu.
5. Select **Delete** from the HDMI input names.
6. Press **MENU** to clear the menus.

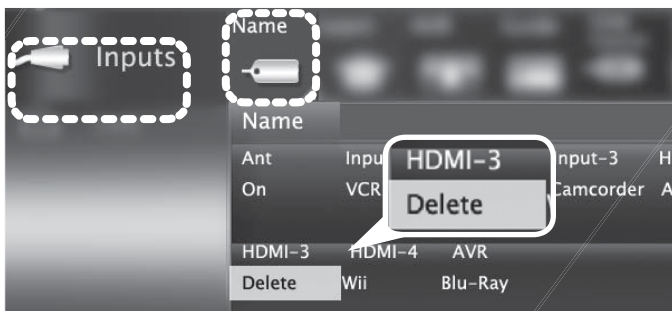

*Inputs > Name menu with **Delete** selected for HDMI-3.*

## Using HDMI Control

As an example of using HDMI Control, press **PLAY** on the device itself to:

- Power on the TV
- Switch to the device (no need to display the **Activity** menu)
- Begin play of the device

### Direct Keys

Test your equipment with the TV's remote control to find additional supported commands. See the table below for commands that may be available, depending on the individual device.

**CEC-enabled VCR, DVD, and DVR functions that may be available:**

Record/Playback	Menu Navigation	Channel Tuning	Other
		CHANNEL UP/DN	GUIDE
	ENTER	Digits 0-9, CANCEL	MENU
	CANCEL (to cancel)	ENTER	

If you have a CEC-enabled A/V receiver, CEC-enabled devices connected to the A/V receiver with an HDMI cable may also be controllable. They can be selected from the TV's **Activity** menu.

**CEC-enabled A/V receiver functions that may be available:**

- Try the **VOLUME UP/DOWN**, **MUTE**, and menu-navigation keys.
- To open the A/V receiver menu, follow these steps:
  1. While watching TV, press **MORE** then **9 (AUDIO)**.
  2. Press **▲** until the **Speakers** option displays.
  3. Press **▶** to select **AVR** as the source.
  4. Press **MORE** and then **1 (MENU)** to display the menu.

### The MORE Menu

Press **MORE** on the TV's remote control to see a menu of additional supported functions for the current CEC-enabled device. To issue a command, press the number key indicated in the menu.

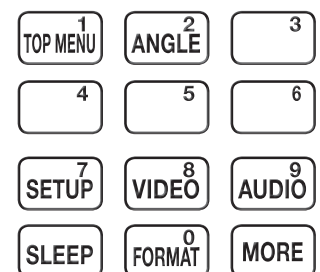

*MORE key: Sample menu for a CEC-enabled DVD player*

## Appendix D: TV Care

### Lamp-Cartridge Replacement and Cleaning

**CAUTION:** If the television is on, press **POWER** to turn it off. Unplug the television and allow it to cool for at least one hour before attempting to replace the lamp cartridge.

#### Lamp

The light source for this television is a lamp, which is part of a lamp cartridge assembly. The life of the lamp can vary, based on the lamp itself, the air temperature around the TV while it is operating, the selected lamp mode, and your viewing patterns. Warmer air or poor ventilation shorten the lamp life, as does use of the **Bright** lamp mode and turning the television on and off frequently. Mitsubishi warrants the lamp for one (1) year from the date of original TV purchase at retail.

#### To Order a New Lamp

##### To Receive a Replacement Lamp Under Warranty

- Visit our website at [www.mitsuparts.com](http://www.mitsuparts.com).
- Call (800) 553-7278. Please have model number, serial number, and TV purchase date available.

**Important:** All lamps replaced under warranty must be returned to Mitsubishi where they will be inspected for defect verification.

##### To Purchase a Replacement Lamp After Warranty

Visit our website at [www.mitsuparts.com](http://www.mitsuparts.com) or call (800) 553-7278. Order the following:

**Lamp Part Number 915B403001**

#### Lamp-Substitution Alert

MDEA recommends that you use only genuine Replacement Lamp Assemblies purchased directly from Mitsubishi or a Mitsubishi Authorized Dealer or Mitsubishi Authorized Service Center. MDEA advises that replacement lamps obtained separately from the Lamp Cartridge and/or Lamp Assemblies obtained from unauthorized sellers may be incorrect for your television, may not fit or perform properly and may even damage your television. MDEA can not be responsible for the performance, reliability or safety of any replacement lamps that are obtained from unauthorized sources.

#### WARNING

- Do not remove the lamp cartridge immediately after turning off the television. You may get burned because the lamp is very hot. Allow the television to cool for at least one hour before replacing the lamp cartridge.
- Do not remove the lamp cartridge except when replacing it. Careless treatment can result in injury or fire.
- Do not touch the lamp glass element. It may be very hot and break, causing injuries or burns.
- Be sure not to insert any metal or flammable object into the lamp cartridge opening, as it may cause fire or electrical shock. If a foreign object is inserted into the opening, unplug the AC cord of the TV and contact your dealer for service.
- Install the lamp cartridge securely. Failure to do so may cause a fire.
- Do not touch the lamp glass elements. Oils from your fingers may cause premature lamp failure.

 = MERCURY

THE LAMP INSIDE THIS PRODUCT CONTAINS MERCURY AND MUST BE RECYCLED OR DISPOSED OF ACCORDING TO LOCAL, STATE OR FEDERAL LAWS. For disposal or recycling information, please contact your local authorities or the Electronic Industries Alliance at [www.eiae.org](http://www.eiae.org)

CAUTION

**BURN DANGER! HOT SURFACES INSIDE!**  
**Touch lamp cartridge handle only. Do not touch lamp or lamp cartridge housing. Keep lamp cartridge horizontal during removal. Do not tilt as glass may come out and cause injury. Replace lamp cartridge only with the same part number 915B403001.**

**WARNING**

THE ACCESS PANEL IS PROVIDED WITH AN INTERLOCK TO REDUCE THE RISK OF EXCESSIVE ULTRAVIOLET RADIATION. DO NOT DEFEAT ITS PURPOSE OR ATTEMPT TO SERVICE WITHOUT REMOVING PANEL COMPLETELY.

## Appendix D: TV Care, continued

### Lamp-Cartridge Replacement

#### Removing the Old Lamp Cartridge

1. Turn off TV power and unplug the TV. Allow the lamp to cool for at least one hour before proceeding.
2. After the lamp has cooled, remove the cover of the lamp compartment, located on the back of the TV. Refer to figures 1 and 2. Use a #2 (medium) Phillips screwdriver to loosen the screw securing the cover. Keep the screw and cover for re-installation.
3. With a medium Phillips screwdriver, loosen the two screws securing the lamp cartridge until they disengage from the mating threads. These are captive screws and cannot be separated from the lamp cartridge.
4. Fully open the bag supplied with the replacement lamp and set the opened bag aside.
5. Gently grasp the handle of the lamp cartridge and pull the old cartridge straight out. See figure 3.

**CAUTION:** Do not tilt or rotate the cartridge, as small glass fragments may fall out.

6. Without tilting or putting down the lamp cartridge, insert it into the opened bag. Close the bag while being careful not to let any glass particles fall out.

#### Installing the New Lamp Cartridge

1. Do not touch the glass parts of the new lamp cartridge. Insert the new cartridge into the TV in the same orientation as the old cartridge. Push on the cartridge housing until it is fully seated.
2. Gently tighten the screws with the screwdriver. **AVOID OVERTIGHTENING!**
3. Replace the plastic cover and retaining screws.
4. **WASH YOUR HANDS THOROUGHLY, AS THIS LAMP CONTAINS MERCURY.**

#### Disposal of the Old Lamp Cartridge

**Lamp under warranty:** All lamps replaced under warranty must be returned to Mitsubishi. Use the return shipping label provided and send to Mitsubishi Digital Electronics, America, 625 Braselton Parkway, Suite 200, Braselton, GA 30517.

**IMPORTANT: Lamps found to be without defect will be returned and charged back to the sender.**

**Lamp no longer under warranty:** Contact your local authorities or the Electronic Industries Alliance at [www.eiae.org](http://www.eiae.org) for lamp-disposal or recycling instructions. Do not dispose of the old lamp with common trash.

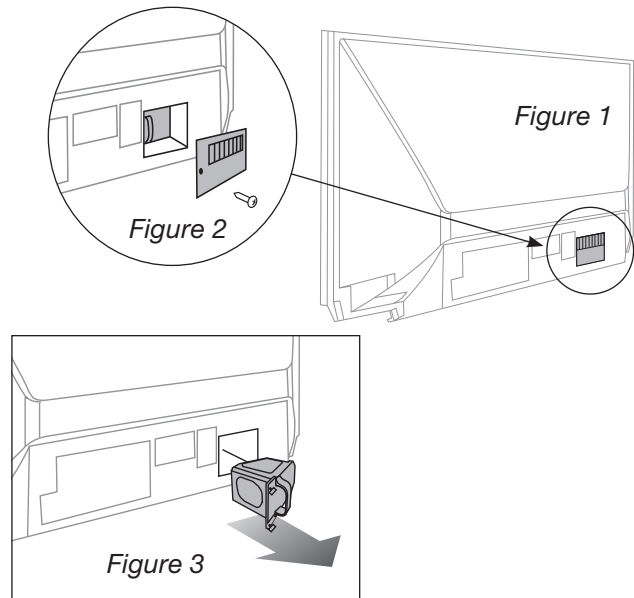

**Use only replacement lamp part number 915B403001.**

### Lamp-Cartridge Filter Cleaning

If the TV shuts off after displaying the message “TV will shut down in a few seconds. Please check if the air flow is blocked” and/or the **STATUS** LED is yellow, the air filter may need cleaning. The air filter is part of the lamp cartridge. Use the following procedure to clean the filter.

1. Remove the lamp cartridge from the TV as described under “Removing the Old Lamp Cartridge.” Do not tilt or rotate the cartridge. Do not touch the glass parts of the lamp cartridge.
2. Holding the lamp cartridge horizontal (do not tilt or rotate), use a soft dry brush or vacuum cleaner to remove any dust that may be present on the mesh filter. Do not use liquids. See figure 4.
3. Reinstall the lamp cartridge as described under “Installing the New Lamp Cartridge.”

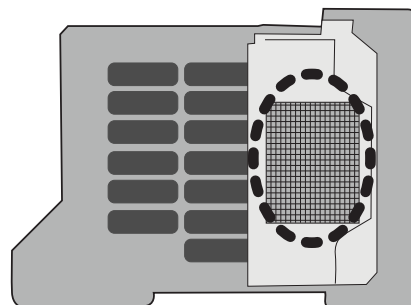

**Figure 4**  
Keep lamp cartridge horizontal and remove dust from the mesh filter using a vacuum cleaner or soft dry brush.

## Appendix D: TV Care, continued

### Cleaning Recommendations

Normally, light dusting with a dry, non-scratching duster will keep your TV clean. If cleaning beyond this is needed, please use the following guidelines:

First, turn off the TV and unplug the power cord from the power outlet.

Occasionally clean dust build-up from the air-intake grilles on the back and sides of the TV. Clean using a vacuum cleaner with a brush attachment.

#### Top and Sides of the TV

- Gently wipe down your TV with a soft, non-abrasive cloth such as cotton flannel, microfiber, or a clean cloth diaper, lightly moistened with water. Dry with a second dry, soft, non-abrasive cloth.
- For oily dirt, add a few drops of mild liquid detergent, such as dishwashing detergent, to the water used to moisten the cloth. Rinse with a second cloth moistened only with water. Dry with a third dry, soft, non-abrasive cloth.

#### Screen

- Follow the instructions for the top and sides, wiping gently in an up and down motion.
- Clean the entire screen evenly, not just sections of the screen.
- Do not allow liquid to drip down the screen, as some liquid may enter the TV through the gap between the screen and screen frame.
- You may purchase Mitsubishi Screen Cleaner, part number CLEANER-VSS, by calling (800) 553-7278.

#### General Cleaning Precautions

- DO NOT allow liquid to enter the TV through the ventilation slots or any crevice.
- DO NOT use any strong or abrasive cleaners, as these can scratch the surfaces.
- DO NOT use any cleaners containing ammonia, bleach, alcohol, benzene, or thinners, as these can dull the surfaces.
- DO NOT spray liquids or cleaners directly on the TV's surfaces.
- DO NOT scrub or rub the TV harshly. Wipe it gently.

### Care of the Remote Control

#### Remote Control Tips

- For longer life, use alkaline batteries.
- Do not mix old and new batteries.
- Be within 20 feet of the equipment.
- Do not press two or more keys at the same time unless instructed to do so.
- Do not allow the unit to get wet or become heated.
- Keep the unit out of direct sunlight.
- Avoid dropping on hard surfaces.
- Do not use harsh chemicals to clean. Use only a soft, lightly moistened cloth.

#### Resetting the Remote Control

If TV mode is selected and the TV does not respond properly, reset the remote control.

1. Press and hold **POWER** for several seconds until the mode indicator blinks twice and goes off.
2. Release the **POWER** key.
3. Press keys **0 0 9 3 5** and the mode indicator will blink twice when you finish entering the code. When entering the code, pause for a moment between each key press to ensure it is recognized.

#### Low-Battery Indicator

If you press a key and the mode indicator blinks five times, replace the remote control's batteries.

## Appendix E: Troubleshooting

### TV Reset Comparison Guide

You can resolve many common TV problems using the reset functions described in the following table. See also the troubleshooting suggestions later in this appendix.

#### IMPORTANT

**Before you change sound or picture settings:** If picture or sound settings seem wrong for a broadcast

channel (a channel from the **ANT** input, a cable box, or satellite receiver), first check other channels from the same input before changing settings. If most other channels from the same input seem correct, there is likely a problem with the broadcast rather than with the TV. Use care in this case, as changes you make to fix problems on individual channels also affect all other channels on the same input.

Reset Name	When to Use	How to Use	Resulting Action
<b>Format</b>	When the picture shape seems incorrect, use <b>MORE &gt; 0 (FORMAT)</b> to change the shape of the picture.	Press the <b>MORE</b> key and then repeatedly press <b>0 (FORMAT)</b> to cycle through the available aspect ratios.	The last-used format for a signal type is memorized for each input. The next time the same input and the same signal type is viewed, the last-used format will be recalled.
<b>PerfectColor™ Reset or PerfectColor™/PerfectTint™ Reset (837 Series)</b> (for the single input currently being watched)	When the color intensities seem out of balance, use the PerfectColor/PerfectTint reset to reset the color balances to the original factory settings. Both PerfectColor and PerfectTint are reset at the same time.	<ol style="list-style-type: none"> <li>1. While viewing the input to be reset, press <b>MENU</b> and go to <b>Adjust &gt; Picture+ &gt; PerfectColor</b>.</li> <li>2. Press <b>ENTER</b> to display the PerfectColor adjustment screen.</li> <li>3. Press <b>CANCEL</b> to reset the colors.</li> </ol>	All PerfectColor/PerfectTint sliders are reset to the original center position. The PerfectColor/PerfectTint settings for other inputs remain unchanged.
<b>A/V Memory Reset</b> (for the single input currently being watched)	When audio and/or video settings for a single input seem incorrect, use A/V Memory Reset to return the input to the original factory settings.	<ol style="list-style-type: none"> <li>1. While viewing the input to reset, press <b>MENU</b> and go to <b>Adjust &gt; Reset</b>.</li> <li>2. Press <b>ENTER</b> to highlight the Reset icon.</li> <li>3. Press <b>ENTER</b> again to reset.</li> </ol>	All Audio and Video settings for the individual input are reset except for the Listen To, Language, audio Balance, Closed Caption, and Advanced Picture settings.

### Service and Customer Support

#### Service

If you are unable to correct a problem with your TV, consult your Mitsubishi dealer or Mitsubishi Consumer Relations at (800) 332-2119.

- DO NOT adjust any controls other than those described in this Owner's Guide.
- DO NOT remove the protective back cover of your TV.

#### Customer Support

- To order replacement or additional remote controls or lamp cartridges, visit our website at [www.mitsuparts.com](http://www.mitsuparts.com) or call (800) 553-7278.
- For questions:
  - ◆ Call Consumer Relations at 800-332-2119.
  - ◆ E-mail: [MDEAservice@mdea.com](mailto:MDEAservice@mdea.com)
  - ◆ Website: [www.mitsubishi-tv.com](http://www.mitsubishi-tv.com)

#### Important

All lamps replaced under warranty must be returned to Mitsubishi where they will be inspected for defect verification.



## Appendix E: Troubleshooting, continued

Reset Name	When to Use	How to Use	Resulting Action
<b>A/V Reset</b> (for all inputs)	To reset audio and video adjustments for all inputs to the original factory settings.	While viewing the TV, press the control-panel buttons <b>ACTIVITY</b> and <b>VOLUME DOWN</b> at the same time.	All Audio and Video settings are returned to the original factory settings, including Listen To, Language, audio Balance, Closed Captions, Format and Advanced Picture settings.
<b>Channel Memorization</b>	To erase and re-memorize channels on the <b>ANT</b> input.	<ol style="list-style-type: none"> <li>1. While viewing the TV, press <b>MENU</b> to display the main menu.</li> <li>2. Navigate to the <b>Initial &gt; Channel</b> menu.</li> <li>3. Press <b>ENTER</b>.</li> <li>4. Highlight the reception mode, e.g. <b>Ant Air</b>.</li> <li>5. Highlight <b>Scan</b>.</li> <li>6. Press <b>ENTER</b> to start channel memorization.</li> </ol>	All previously memorized channels for the antenna input are erased and a new set of memorized channels is created. To add or delete individual channels, see <b>Initial &gt; Channel &gt; Edit</b> menu instructions on page 39.
<b>Lock Menu Pass Code</b>	To change your <b>Lock</b> menu pass code	See the cutout page from Appendix A, page 57.	Allows establishment of a new code.
<b>Control-Panel Lock Release</b>	To re-enable the control-panel buttons after activation of the Control-Panel Lock	Press and hold the <b>ACTIVITY</b> button on the control panel for over eight seconds. This works even if the TV is powered off.	Allows the control panel to be unlocked if the remote control is misplaced.
<b>Auto Input Sensing for HDMI</b>	When connecting an HDMI device does not trigger Auto Input Sensing.	<ol style="list-style-type: none"> <li>1. Disconnect the HDMI device.</li> <li>2. Delete the HDMI input in the <b>Inputs &gt; Name</b> menu (see page 40).</li> <li>3. Power on and connect the new device.</li> </ol>	The <b>New Device Found</b> screen will display.
<b>System Reset</b>	If the TV does not turn on or off, does not respond to the remote control or control-panel buttons, or has audio but no video.	Press and hold the <b>POWER</b> button on the control panel for ten seconds.	The TV will turn off and the green LED will flash quickly for about one minute. When the green LED stops flashing, you may turn on the TV. The changes you made most recently, before using <b>SYSTEM RESET</b> , may be lost.
<b>TV Reset</b> <b>IMPORTANT:</b> Use this reset only if all other resets have been unsuccessful.	To reset all consumer-accessible settings and all memories to the original factory defaults.  <b>CAUTION:</b> All owner-performed setups and adjustments will be erased.	<ol style="list-style-type: none"> <li>1. While viewing the TV, press <b>MENU</b> to display the TV main menu.</li> <li>2. With the main menu displayed, press number keys <b>1 2 3</b> to display the <b>Reset</b> menu.</li> <li>3. <b>READ THE ON-SCREEN WARNING AND INSTRUCTIONS.</b> <ul style="list-style-type: none"> <li>• If you do not wish to use this reset, press <b>BACK</b> or <b>MENU</b> to back out.</li> <li>• If you do wish to use the reset, press <b>ENTER</b> to erase all memories and settings.</li> </ul> </li> </ol>	The TV will start the initialization process. The TV will then turn off and the front green LED will start flashing. When the LED stops flashing, you can turn on the TV again. All memory and settings outlined in this Owner's Guide will need to be set again.

## Appendix E: Troubleshooting, continued

General TV Operation		
	Symptom	Remarks
1.	A fan is running even while the TV is powered off.	The room is too warm. When the TV is off, internal components continue to draw power and must be cooled by the fan.
2.	The fan gets louder after the TV is shut off.	Normal operation. The fan speeds up to cool the lamp quickly after the TV has been shut off.
3.	The TV remote control does not work.	<ul style="list-style-type: none"> <li>• Check that the batteries are fresh and installed correctly.</li> <li>• Check that the control mode on the remote is set to TV.</li> <li>• Be no more than 20 feet from the TV when using the remote control.</li> <li>• Program the remote control to operate the TV or other device.</li> <li>• Reset the remote control.</li> </ul>
4.	When I try to use the remote control, the POWER key blinks five times.	Replace the batteries.
5.	TV does not respond to the remote control or to control-panel buttons and TV will not power on or off.	<ul style="list-style-type: none"> <li>• Unplug the AC power cord for 10 seconds.</li> <li>• Press and hold the POWER button on the control panel to perform system reset.</li> </ul>
6.	When a device is selected from the Activity menu, the screen is blue or black (no signal source).	<ul style="list-style-type: none"> <li>• Make sure the selected device is turned on.</li> <li>• Begin play of the device.</li> </ul>
7.	You have forgotten your Lock menu pass code.	See “Bypassing the Parental Lock”, Appendix A.
8.	Rating restrictions are not working.	Open the Lock > Parental Lock menu and: <ul style="list-style-type: none"> <li>• Verify that the ratings locks are active.</li> <li>• Check the Lock Time/Unlock Time to check if rating restrictions are disabled.</li> <li>• Rating restrictions apply only to content on the ANT input.</li> </ul>
9.	On-screen displays appear each time you change a function.	Normal TV operation.
10.	A warning message appeared on screen stating, “TV will shut down in a few seconds. Please check if the air flow is blocked.”	<ul style="list-style-type: none"> <li>• Internal TV temperature has exceeded proper levels. Cool the room.</li> <li>• The TV has overheated. Clear blocked air vents and ensure at least four inches of clearance on all sides of the TV.</li> <li>• Clean the air filter on the lamp cartridge.</li> </ul>
11.	I have turned on CEC for my HDMI devices but control is erratic and I wish to disable it.	<ul style="list-style-type: none"> <li>• First turn off the TV's HDMI control for the specific device. Open the Inputs &gt; HDMI Control menu, select the device, select Off.</li> <li>• Disable CEC on the device itself. See the device's instructions.</li> <li>• If the problem persists, do the following:               <ol style="list-style-type: none"> <li>1. Disconnect the device from the TV.</li> <li>2. Reconnect the device to the TV and Auto Input Sensing will recognize the device with CEC disabled.</li> </ol> </li> </ul>

## Appendix E: Troubleshooting, continued

TV Channels		
	Symptom	Remarks
1.	The TV takes several seconds to respond to channel changes.	<ul style="list-style-type: none"> <li>It is normal for digital channels to take longer to tune in.</li> <li>Press ENTER after entering a channel number to avoid delays.</li> <li>Use a 4-digit number for an over-the-air digital channel.</li> <li>Use a 6-digit number for digital cable channels if your cable service is able to recognize 6-digit channel numbers.</li> </ul>
2.	You cannot access a channel.	<ul style="list-style-type: none"> <li>Use number keys instead of CHANNEL Up/Down.</li> <li>Be sure the channel you want to view is in memory.</li> <li>Check that the TV is switched to the correct device or antenna for that channel by pressing the ACTIVITY key.</li> <li>Make sure the Lock &gt; Parent menu lock is set to Off.</li> <li>If you cannot tune to a virtual digital channel even though the TV has already memorized digital channels, tune to the physical channel number used by the broadcaster. The virtual channel will then be automatically added to memory.</li> <li>You may be trying to tune to an analog channel that is no longer broadcasting.</li> </ul>
3.	When ChannelView list is displayed, information appears incomplete	<ul style="list-style-type: none"> <li>Press INFO to update the display for the highlighted channel.</li> <li>Program information is displayed only for the currently tuned channel.</li> <li>Available information is sent from the broadcaster or cable provider. No other data is available.</li> <li>Make sure the TV clock is set correctly.</li> </ul>

TV Power On/Off		
	Symptom	Remarks
1.	TV takes an excessively long time to power on.	When powered on, the TV needs time to boot up, just as a computer does. Also, the TV's lamp requires a few moments to heat up to full brightness.
2.	You cannot program the TV to turn on automatically (Timer function)	<ul style="list-style-type: none"> <li>The TV may be locked.</li> <li>The clock may not be set.</li> </ul>
3.	TV turned itself off and the light on the front panel started to blink.	<ul style="list-style-type: none"> <li>Momentary power fluctuation caused the TV to turn off to prevent damage. Wait for the green light to stop flashing and turn the TV on again.</li> <li>If the TV does not stay on, press the POWER button on the control panel for at least eight seconds to perform System Reset. If this happens frequently, obtain an AC line power conditioner/surge protector.</li> <li>An unusual digital signal may have been received, triggering a protection circuit. Wait for the light to stop flashing and turn TV on.</li> </ul>
4.	TV will not power off.	Press the POWER button on the control panel for ten seconds to perform System Reset.

## Appendix E: Troubleshooting, continued

Picture		
	Symptom	Remarks
1.	Picture does not look like a high-definition picture.	Not all signals are high-definition signals. To receive high-definition programming from your cable or satellite provider, you must subscribe to the provider's high-definition service. Some over-the-air broadcasts are in high-definition and can be received with a high-quality antenna suited to your location.
2.	TV has sound but no picture.	<ul style="list-style-type: none"> <li>• Check that all video inputs are plugged in firmly.</li> <li>• Press and hold the POWER button on the control panel for ten seconds to perform System Reset.</li> </ul>
3.	Picture has become dimmer.	<ul style="list-style-type: none"> <li>• The lamp is nearing the end of its life. Order a new lamp.</li> <li>• Adjust picture brightness and contrast to maximum levels.</li> <li>• Change Lamp Energy from Standard to Bright.</li> </ul>
4.	There is a large black or gray rectangle on the screen.	The TV's analog closed captioning has been set to "text" mode in the Captions menu. Turn off because there is no text information being broadcast.
5.	You cannot view a picture when playing a VHS tape.	Check your VCR's owner's guide for further troubleshooting.
6.	VCR or DVD player's on-screen menus jitter up and down.	Stop playback. Possible cause: Many VCRs and DVD players provide on-screen menus at only half-resolution that may appear to jitter up and down.
7.	When viewing a stopped VCR, white lines are rolling on the screen.	<ul style="list-style-type: none"> <li>• Turn off video mute for the VCR.</li> <li>• Begin playing the tape.</li> <li>• Change the VCR input from Line 1 to the VCR antenna input.</li> </ul>
8.	A color program appears as a black and white image, or the colors are dim, or the screen is black.	The PerfectColor color balance has been incorrectly set. Reset the PerfectColor balance.
9.	Picture from an HDMI input is noisy (poor quality).	Upgrade a Category 1 (unmarked) HDMI cable to a Category 2 high-speed HDMI cable.
10.	The image from a computer appears distorted when viewed on the TV.	<ul style="list-style-type: none"> <li>• Normal TV operation. The TV does not correct distortion in the picture from a computer because the correction process may cut off the edges of the image.</li> <li>• The aspect ratio may be wrong for the image. Press MORE and then 0 (FORMAT) to change.</li> </ul>

Sound		
	Symptom	Remarks
1.	There is no sound even when the volume is turned up.	<ul style="list-style-type: none"> <li>• Check if the MUTE key is on.</li> <li>• The TV's "Listen to:" setting may be set to SAP (analog program from the ANT input).</li> <li>• Check that the Speakers option is set to TV to hear sound from the TV speakers. Sound may be being sent to one of the audio outputs for an A/V receiver or headphones.</li> <li>• If using an A/V receiver, check that the Speakers option is set to AV Receiver to hear sound from the A/V receiver speakers.</li> <li>• Press and hold the POWER button on the control panel for 10 seconds to perform System Reset.</li> </ul>

**Appendix E: Troubleshooting, continued**

Sound		
	Symptom	Remarks
2.	The sound does not match the screen picture.	The TV's "Listen to:" setting may be set to SAP (analog program from the ANT input).
3.	The sound from my A/V receiver does not match the screen picture (I should hear the correct audio from my A/V receiver).	<ul style="list-style-type: none"> <li>• Check that DIGITAL AUDIO OUTPUT and/or AVR AUDIO OUTPUT on TV's main panel is connected to the A/V receiver. Without this connection, devices connected only to the TV (and not the A/V receiver) can be heard only from the TV speakers. Note that this includes the ANT input, a device (such as a camcorder) connected to the convenience panel, and any other device sending audio to the TV only.</li> <li>• If using a NetCommand-controlled A/V receiver, NetCommand may be selecting the wrong A/V receiver audio input. Check the A/V receiver's NetCommand setup in the Inputs &gt; AVR menu.</li> <li>• If playing MP3 files from a USB device, check that the TV's audio output is connected to the A/V receiver.</li> </ul>
4.	Cannot select an audio-only device; it does not appear in the Activity menu.	Plug an unused video plug into the <b>Y/VIDEO</b> jack to activate Auto Input Sensing and make the audio device selectable in the Activity menu.

NetCommand IR Control (NetCommand-equipped models only)		
	Symptom	Remarks
1.	Cannot see the menu from the A/V Receiver.	<ul style="list-style-type: none"> <li>• <b>A/V Receiver Set Up for Audio-Only Switching</b> The A/V Receiver is not connected to any video input of the TV. To check the A/V Receiver menu, temporarily plug into an unused input of the TV, such as Input 3. Exit the New Device Found screen and select Input 3 from the Activity menu. Press MENU on the A/V receiver's remote control.</li> <li>• <b>A/V Receiver Set Up for Audio and Video Switching over HDMI</b> Use the MENU key on the A/V receiver's remote control.</li> <li>• <b>A/V Receiver with HDMI Control</b> Switch the remote control to AUDIO mode. Press the MORE key and then 1 (Menu).</li> </ul>
2.	NetCommand unable to learn specific device keys.	<ul style="list-style-type: none"> <li>• A/V Device does not use IR format for remote control signal. ITT and RF formats cannot be learned.</li> <li>• Room lighting may affect the signal. Have the remotes very close (6 inches or less) to the TV during Learning.</li> <li>• If learning a Mitsubishi remote control, make sure mode is not set to TV.</li> <li>• Some, but not all, device key functions can be learned by NetCommand. For example, POWER and PLAY may be learned, but other functions may not.</li> <li>• The signal from the remote control may not be strong enough. Insert fresh batteries and try Learning again.</li> </ul>

## Appendix E: Troubleshooting, continued

NetCommand IR Control (NetCommand-equipped models only)	
Symptom	Remarks
3. The A/V receiver is the selected audio source but there is no sound.	<ul style="list-style-type: none"> <li>• A/V Receiver Set Up for Audio-Only Switching               <ul style="list-style-type: none"> <li>- Check to see if the A/V Receiver power is turned on.</li> <li>- With A/V receiver power turned on, redisplay the Activity menu and press ENTER to allow NetCommand to correctly select the A/V Receiver input.</li> <li>- Incorrect setup in the Inputs &gt; AVR menu. Check the device connection assigned in the AVR menu.</li> </ul> </li> <li>• A/V Receiver Set Up for Audio and Video Switching over HDMI               <ul style="list-style-type: none"> <li>- Check to see if the A/V Receiver power is turned on.</li> <li>- If the device is connected only to the TV (e.g., on ANT or a front panel input), verify that the TV's AUDIO OUTPUT is connected to the A/V receiver.</li> <li>- The A/V receiver is not switching properly because you have not learned the IR codes for the A/V receiver inputs to which your devices are connected.</li> </ul> </li> </ul>
4. There is no sound from the A/V receiver for my DVD player or other surround sound device even though I learned the IR code for the A/V receiver's DVD input or other input. (A/V Receiver Set Up for Audio-Only Switching)	NetCommand A/V receiver setup for the DVD player or digital surround sound device or other device is not switching properly. See the owner's guide and perform A/V receiver setup for a digital surround sound device.
5. There is no sound or picture from the A/V receiver for my DVD player or other device connected to the A/V receiver; the A/V receiver should be sending video to the TV over an HDMI cable. (A/V Receiver Set Up for Audio and Video Switching over HDMI)	NetCommand A/V receiver setup is not switching audio and video inputs properly. See the owner's guide.
6. I've selected my DVD player or other surround sound device in combination with the TV speakers but hear no sound from the TV speakers.	<ul style="list-style-type: none"> <li>• A/V Receiver Set Up for Audio-Only Switching               <p>If you have only an audio connection from the device to the A/V receiver, a physical audio connection from the device to the TV is also required.</p> <ul style="list-style-type: none"> <li>- Connect the left and right audio output from the device to the appropriate TV audio input. Now you can hear audio from the device through either the TV speakers or the A/V receiver.</li> <li>- To switch audio sources, press MORE 9 (Audio), press ▲ ▼ to show the Speakers option, then press ► to select AV Receiver or TV.</li> </ul> </li> <li>• A/V Receiver Set Up for Audio and Video Switching over HDMI               <p>With your DVD player connected to the A/V receiver, only video is passed from the A/V receiver to the TV because of copy-protection restrictions on the HDMI signal</p> </li> </ul>
7. I "learned" the RECORD key for my VCR/DVR but when I pressed the RECORD key, the VCR/DVR did not record anything.	Check that the VCR or DVR is receiving a signal directly from your cable box or satellite receiver.

## Trademark and License Information

LICENSOR'S SUPPLIERS DO NOT MAKE OR PASS ON TO END USER OR ANY OTHER THIRD PARTY, ANY EXPRESS, IMPLIED OR STATUTORY WARRANTY OR REPRESENTATION ON BEHALF OF SUCH SUPPLIERS, INCLUDING, BUT NOT LIMITED TO THE IMPLIED WARRANTIES OF NON-INFRINGEMENT, TITLE, MERCHANTABILITY OR FITNESS FOR A PARTICULAR PURPOSE.

Digital Light Processing® and DLP® are registered trademarks of Texas Instruments.

Manufactured under license from Dolby Laboratories. Dolby is a trademark of Dolby Laboratories.

HDMI™ the HDMI logo and High-Definition Multimedia Interface are trademarks or registered trademarks of HDMI Licensing LLC.

The software in this TV is based in part on the work of the Independent JPEG Group, copyright © 1991-1998, Thomas G. Lane, all rights reserved.

**x.v.Color** and the **x.v.Color** logo are trademarks of Sony Corporation.

ChannelView™, DeepField™ Imager, Easy Connect™, NetCommand®, PerfectColor™, PerfectTint™, Plush 1080p® 5G, SharpEdge™, Smooth120Hz™ are trademarks of Mitsubishi Digital Electronics America, Inc.

# Mitsubishi TV Software

## END-USER LICENSE AGREEMENT FOR EMBEDDED SOFTWARE

**IMPORTANT – READ CAREFULLY:** This License Agreement is a legal agreement between you (either an individual or an entity) and Mitsubishi Digital Electronics America, Inc. (MDEA) for all software pre installed and/or provided along with this television (“Software”). By utilizing this television and Software, you agree to be bound by the terms of this License Agreement.

The Software is protected by United States copyright laws and international treaty provisions, as well as other intellectual property laws and treaties. The Software is licensed, not sold.

1. **LICENSE GRANT.** MDEA grants you a non-exclusive, non-transferable, limited right and license to use one copy of the Software only with the Mitsubishi television model that included this owner’s guide and owned by you.

2. **RIGHTS AND LIMITATIONS.**

Software Not for Resale. You may not resell or otherwise transfer for value the Software, except in conjunction with a sale of the TV that Software has been pre installed.

Prohibition on Reverse Engineering, Decompilation and Disassembly. The Software contains trade secrets or other proprietary material in its human perceivable form and to protect them, you may not reverse engineer, decompile, or disassemble, or otherwise reduce the Software to any human perceivable form, except to the extent that the foregoing restriction is expressly prohibited by applicable law.

Separation of Components. The Software is licensed as a single product. Its component parts may not be separated for use on more than one TV.

No Rental. You may not rent, lease, lend, or sublicense the Software.

Trademarks. This License Agreement does not grant you any rights to any trademarks of MDEA.

3. **VIOLATIONS.** You understand that any use, copying or transfer of the Software, except as permitted pursuant to this License, may subject you to serious criminal and civil penalties including damages and an award to MDEA of attorneys’ fees in connection with any violation of this License. You further understand that you may be held legally responsible for any copyright infringement or other violation of intellectual property rights that is caused, encouraged, or induced by your failure to abide by the terms of the License. This license is effective until terminated, and will terminate immediately without notice from MDEA or judicial resolution if you fail to comply with any provision of this License.

4. **COPYRIGHT.** All title and intellectual property rights in and to the Software (including but not limited to any images, photographs, animations, video, audio, music, text, and “applets” incorporated into the Software), and any accompanying printed materials are owned by or licensed to MDEA. All title and intellectual property rights in and to the content which may be accessed through use of the Software is the property of the respective content owner and may be protected by applicable copyright or other intellectual property laws and treaties. This License Agreement grants you no rights to use such content, except that you own the media on which the Software is recorded, but MDEA and its licensors retain ownership of the Software itself. All rights not expressly granted are reserved by MDEA.

5. **EXPORT RESTRICTIONS.** MDEA is licensing the Software for use within the United States. You agree that you will not export or re-export the Software. You specifically agree not to export or re-export the Software: (i) to any country to which the U.S. has embargoed or restricted the export of goods or services, which currently include, but are not necessarily limited to Cuba, Iran, Iraq, Libya, North Korea, Sudan, and Syria, or to any national of any such country, wherever located, who intends to transmit or transport the Software back to such country; (ii) to any person or entity who you know or have reason to know will utilize the Software in the design, development, or production of nuclear, chemical, or biological weapons; or (iii) to any person or entity who has been prohibited from participating in U.S. export transactions by any federal agency of the U.S. government. You warrant and represent that neither the BXA nor any other U.S. federal agency has suspended, revoked, or denied your export privileges.

6. **DISCLAIMER OF WARRANTY. EXCEPT AS OTHERWISE PROVIDED IN THIS LICENSE OR IN THE LIMITED WARRANTY APPLICABLE TO THE TV, MDEA MAKES NO OTHER WARRANTIES OF ANY KIND WHATSOEVER REGARDING THE SOFTWARE AND HEREBY EXPRESSLY DISCLAIMS ALL WARRANTIES OF ANY KIND WHATSOEVER, EXPRESS OR IMPLIED, WITH RESPECT TO THE SOFTWARE. ALL IMPLIED WARRANTIES, INCLUDING, WITHOUT LIMITATION, THE IMPLIED WARRANTIES OF MERCHANTABILITY AND FITNESS FOR A PARTICULAR PURPOSE ARE HEREBY EXPRESSLY DISCLAIMED BY MDEA. IN NO EVENT SHALL MDEA BE LIABLE TO YOU OR ANY THIRD PARTIES, IN CONTRACT, IN TORT OR OTHERWISE, FOR ANY DIRECT, INDIRECT, SPECIAL, INCIDENTAL OR CONSEQUENTIAL DAMAGES OF ANY KIND OR NATURE. BECAUSE SOME JURISDICTIONS DO NOT ALLOW THE EXCLUSION OR LIMITATION OF IMPLIED WARRANTIES, THE ABOVE LIMITATION MAY NOT APPLY TO YOU.**

7. **LIMITATION OF LIABILITY. MDEA SHALL NOT, UNDER ANY CIRCUMSTANCES BE LIABLE TO YOU OR ANY THIRD PARTIES FOR ANY DAMAGES OF ANY NATURE, WHETHER INDIRECT, SPECIAL, INCIDENTAL, CONSEQUENTIAL OR OTHERWISE, INCLUDING, BUT NOT LIMITED TO, ANY CLAIMS FOR LOST PROFITS, LOSS OF GOOD WILL OR EXPENDITURES MADE OR COMMITTED FOR IN RELIANCE ON THE CONTINUATION OF THIS LICENSE. YOU AGREE THAT NEITHER MDEA’S BREACH OF THIS LICENSE NOR ITS FAILURE TO REPAIR A DEFECT, ERROR OR BUG SHALL CONSTITUTE A FAILURE OF THE ESSENTIAL PURPOSE OF THIS LICENSE. BECAUSE SOME JURISDICTIONS DO NOT ALLOW THE EXCLUSION OR LIMITATION OF LIABILITY FOR CONSEQUENTIAL OR INCIDENTAL DAMAGES, THE ABOVE LIMITATIONS MAY NOT APPLY TO YOU. MDEA’S liability to you for direct damages for any cause whatsoever and regardless of the form of the action, will be limited to the money paid by you for the TV (based on fair market value of the TV) that caused the damages.**

8. **GENERAL.** This License Agreement will be governed by the laws of the State of California.

**WARNING:** This product contains chemicals known to the State of California to cause cancer and/or birth defects or other reproductive harm.



## Mitsubishi DLP Projection Television Limited Warranty

MITSUBISHI DIGITAL ELECTRONICS AMERICA, INC. ("MDEA") warrants as follows to the original purchaser of this television from an authorized MITSUBISHI Audio/Video Dealer, should it prove defective by reason of against defects arising from improper workmanship and/or material:

**a. Parts.** The lenticular (i.e. front picture) screen is warranted against defects in materials and workmanship for a period of thirty (30) days from the date of the original purchase at retail. The lamp and all other parts (except any software incorporated into this television) are warranted for a period of one (1) year from the date of the original purchase at retail. We will repair or replace, at our option, any defective part without charge for the part. Parts used for replacement may be replaced with those of like kind and quality and may be new or remanufactured. Parts used for replacement are warranted for the remainder of the original warranty period.

**b. Embedded Software.** MDEA warrants that all software incorporated into this television set (the "Embedded Software") will perform in accordance with the functional description of Embedded Software in all material respects, but MDEA does not warrant that the Embedded Software is error-free. The limited warranty contained in this section shall continue for a period of one (1) year from the date of the original purchase at retail. If, after prompt notice within the warranty period, MDEA determines that the Embedded Software has failed to perform in accordance with such functional description in all material respects and if such failure is not due to accident, misuse, modification or misapplication of the Embedded Software, then MDEA shall modify or replace the nonconforming Embedded Software at no charge to you, which at MDEA's sole discretion may be fulfilled by means of modification or replacement software contained on a replacement memory card for Customer installation. The foregoing shall be MDEA's sole obligation to you under this limited warranty. All rights under this limited warranty on the Embedded Software also subject to your acceptance of and compliance with the terms of the Software License Agreement applicable to this television, and this limited warranty on the Embedded Software shall be null and void if the Embedded Software is modified or changed in any manner except as specifically authorized by MDEA.

**c. Labor.** For thirty (30) days after the original purchase at retail, we will repair or replace, at our option, the lenticular screen if it proves defective. For certain items that are designed to be replaced by the consumer, including (but not limited to) some Embedded Software, the consumer is solely responsible for any replacement labor. For all other parts, we will provide the labor for a warranty repair by an authorized MITSUBISHI service center without charge for one (1) year from the original date of purchase at retail.

**d. Notice.** To obtain warranty service, you must notify an authorized MITSUBISHI service center of any defect within the applicable warranty time period.

e. This DLP Projection Television uses a single DLP chip to create the screen image. This technology creates the image using small dots, or picture elements (pixels). Your DLP Projection TV is manufactured to a high level of performance and quality, in fact, 99.99% perfect in the number of properly functioning pixels. As in other display technology, sometimes a pixel is continuously active, inactive or the incorrect color. Our standard is clear; MDEA warrants only that the percentage of properly functioning pixels will be not less than 99.99% of all pixels.

**BEFORE REQUESTING SERVICE, please review the instruction booklet to insure proper installation and correct customer control adjustment. If the problem persists please arrange for warranty service.**

### 1. TO OBTAIN WARRANTY SERVICE:

a. Contact your nearest authorized MITSUBISHI service center, whose name and address can be obtained from your MITSUBISHI dealer, by writing at the address provided below, calling MDEA at the 800-332-2119, or by using the support feature of our website at [www.Mitsubishi-tv.com](http://www.Mitsubishi-tv.com).

b. Warranty service will be provided in your home or, if required, at an authorized service shop, provided that your television is located within the geographic territory customarily covered by an authorized MITSUBISHI service center. If not, you must either deliver your television to an authorized service location at your own expense, or pay for any travel and/or transportation costs the service center may charge to and from your home. Actual service labor will be provided without charge.

c. Proof of purchase date from an authorized MITSUBISHI dealer is required when requesting warranty service. Present your sales receipt or other document which establishes proof and date of purchase. THE RETURN OF THE

OWNER REGISTRATION CARD IS NOT A CONDITION OF COVERAGE UNDER THIS LIMITED WARRANTY. However, please return the Owner Registration Card so that we can contact you should a question of safety arise which could affect you.

d. To obtain a replacement lamp, order the lamp directly from the MDEA Parts Department at (800) 553-7278.

**2. THIS LIMITED WARRANTY DOES NOT COVER:**

a. Up to .01% pixel outages (small dot picture elements that are dark or incorrectly illuminated).

b. Damage to the lenticular screen or Fresnel lens, screen frame, cosmetic damage or to any other damage where such damage is caused by unauthorized modification, alteration, repairs to or service of the product by anyone other than an authorized MITSUBISHI service center; physical abuse to or misuse of the product (including any failure to carry out any maintenance as described in the Owner's Guide including air vent cleaning or any product damaged by excessive physical or electrical stress); any products that have had a serial number or any part thereof altered, defaced or removed; product use in any manner contrary to the Owner's Guide; freight damage; or any damage caused by acts of God or other factors beyond the reasonable control of MDEA, such as power surge damage caused by electrical system or lightning. This limited warranty also excludes service calls where no defect in the product covered under this warranty is found, service calls related to unsatisfactory audio or visual reception or signal unless caused by a defect in the product that is covered under this limited warranty, all costs, expenses or any other damages arising from product installation, or set-ups, any adjustments of user controls (including contrast, brightness, color, tint, fine tuning, sharpness), other adjustment necessary to prepare the unit for display or use, connection with any external audio receiver, antenna, cable or satellite systems, or service of products purchased or serviced outside the U.S.A. Please consult the operating instructions contained in the Owner's Guide furnished with the product for information regarding user controls.

3. ANY EXPRESS WARRANTY NOT PROVIDED HEREIN, AND ANY REMEDY WHICH, BUT FOR THIS PROVISION, MIGHT ARISE BY IMPLICATION OR OPERATION OF LAW, IS HEREBY EXCLUDED AND DISCLAIMED. THE IMPLIED WARRANTIES OF MERCHANTABILITY AND OF FITNESS FOR ANY PARTICULAR PURPOSE ARE EXPRESSLY LIMITED TO A TERM OF ONE YEAR.

4. UNDER NO CIRCUMSTANCES SHALL MDEA BE LIABLE TO PURCHASER OR ANY OTHER PERSON FOR ANY INCIDENTAL, SPECIAL OR CONSEQUENTIAL DAMAGES, WHETHER ARISING OUT OF BREACH OF WARRANTY, BREACH OF CONTRACT, OR OTHERWISE.

5. Some states do not allow limitations on how long an implied warranty lasts, or the exclusion or limitation of incidental, special, or consequential damages, so the above limitations or exclusions may not apply to you.

6. This limited warranty gives you specific legal rights, and you may also have other rights which vary from state to state.

7. In the event of any dispute under this limited warranty, jurisdiction and venue for resolving that dispute will be in the state where the television was purchased and the laws of such state will govern.



MITSUBISHI DIGITAL ELECTRONICS AMERICA, INC.  
9351 Jeronimo Road  
Irvine, CA 92618-1904

# Index

- A**
- Accent Lighting 33
  - Activity Menu 21
    - Automatic Generation 41
    - Change Input Name 40
    - Customizing 40
    - NetCommand-Controlled Switching of A/V Receiver Inputs 48
    - Removing a Disconnected HDMI Device 40
  - Anamorphic Picture Format 24
  - Antenna Input (ANT) 15, 16
    - Signal Strength for Digital Channels 23
  - Audio Lock (A/V receiver control) 60
  - Audio Output Jacks 15, 16
  - Auto Input Sensing 11
  - Auto-Off (Sleep Timer) 21
  - Auto-On (Timer) 38
  - A/V Receiver
    - and Speakers Option 36
    - and TV's Remote Control 59
    - Audio Lock 60
    - Connecting 16, 20
    - Controlling Sound Volume 22
    - Disconnecting Analog 22
    - NetCommand IR Control 51, 52
      - Controlling a Device Connected to the A/V Receiver 31, 55
      - Video and Audio Switching via HDMI 55
- B**
- Batteries 7
  - Blue Glow 33
  - Bright (Lamp Mode) 39
  - Brightness (picture adjustment) 35
- C**
- Cable Box
    - and TV's Remote Control 59
    - Connecting 17, 18, 19
  - Captions Menu 37
  - CEC (Consumer Electronics Control) 31, 66
    - A/V Receiver 22, 67, 77
    - Troubleshooting 74
  - Channels
    - antennaweb.org 39
    - Physical/Virtual Channel Numbers 39
    - Scan (memorize) 10, 39
    - Troubleshooting 75
  - ChannelView™ Channel Listings 22
  - Cleaning 71
  - Clock, Set Date and Time 38
  - Closed Captions 37
  - Color Adjustments 34
    - Reset Color 34, 72
  - Computer
    - and Display Formats 27
    - Connecting 26
  - Contrast 35
  - Control Panel 9
  - Control Panel Lock 9, 44
- D**
- Date. *See* Clock
  - Default Settings, Returning to 72
  - DIGITAL AUDIO OUT 16
  - Dolby Digital 16, 54
  - DVD Player
    - and TV's Remote Control 59
    - Connecting 17, 18
  - DVI Device, Connecting 18
- F**
- Fan Noise 4
  - Film Mode 33
  - Filter, Air (on lamp cartridge) 70
  - Font (digital closed captions) 37
  - FORMAT (aspect ratio, MORE menu) 24
  - Freeze Picture (PAUSE key) 8
  - Front Panel
    - Blue Glow Accent Lighting 33
    - Controls 9
- G**
- Game
    - 3D Video 25
    - Game Picture Mode 35
    - HDMI Cables for Games 16
  - GUIDE Key
    - ChannelView 22
    - HDMI Control 68
    - NetCommand Control 48, 50
- H**
- HD (High-Definition) Signal) 24
  - HDMI
    - Changing Out an HDMI Device and Auto Input Sensing 11
    - Connecting an HDMI Device 17
      - A/V Receiver with HDMI 20
    - HDMI Cable Categories 16
    - HDMI Control of CEC Devices 66
    - HDMI Jack 16
    - Removing an HDMI Device from the Activity Menu 40
  - Headphones
    - Jack 16
    - Speakers Option 36
- I**
- INFO Key
    - ChannelView 22
    - USB Menu 28
  - IR Emitter Placement 46
  - IR NetCommand Output (jack) 16
- L**
- Lamp Cartridge Replacement 69
  - Lamp Mode 39
  - Language
    - Changing the Menu Language 38
      - in Digital Programs 36
      - SAP (Second Audio Program) 36
  - Learn 40. *See also* NetCommand IR Control
  - Letter Box Image Display 24
  - Level Sound 36
  - Listen To 36
  - Listings 22
  - Lock TV
    - Bypassing the Lock 57
    - Lock by Ratings 43
    - Lock by Time 44
    - Lock Control Panel 44
    - Preset V-Chip Blocking 42
- M**
- Memorizing Channels 10, 39
    - Add Single Channel to Memory 39
  - MP3 Player (audio-only connection) 15
  - Mute
    - Closed Captions 37
    - MUTE Key 8
    - Video Mute 33
- N**
- Name (Inputs > Name menu) 40
  - NetCommand IR Control
    - About 45
    - A/V Receiver Control 52
    - Initial Setup for Most Devices 47
    - Operating 48
    - Troubleshooting 77
- P**
- Parental Menu 43
  - Pass Code
    - Resetting 57
    - Setting 42
  - PAUSE Key 8
  - PerfectColor 34
  - PerfectTint 34
  - Photo Viewing 29

## Picture

- Picture+ Adjustments 34
- Picture Menu Adjustments 35
- Picture Quality and Film Mode 33
- Troubleshooting 76

## Power On/Off 9, 12

- Troubleshooting 75

**R**

## Ratings (TV and Movie) 43

## Remote Control

- Batteries 7
- Keys and Functions 8
- Programming Codes (reference chart) 61
- Programming Instructions 60
- Reset 71

## Reset

- A/V Memory Reset (for the current input) 72
- A/V Reset (for all inputs) 73
- HDMI Auto Input Sensing 11
- Pass Code 57
- PerfectColor/PerfectTint 72
- Remote Control 71
- Remote Control Audio Lock 60
- System Reset 9
- TV Reset Comparison Guide 72

## RS-232C 16

**S**

## Safety Instructions 5

## SAP (second audio program) 36

## Satellite Receiver

- and the Remote Control 59
- Connecting 17, 18

## Scan (memorize channels) 39

## ScreenSaver 33

## SD (Standard-Definition Signal) 24

## Service and Support 72

## Signal Definitions 24

## Signal Strength Indicator 23

## Sleep Timer 21

## Sound

- Controlling A/V Receiver Volume (NetCommand) 52
- Audio Lock 60
- Level Sound 36

## Sound Mode (audio effects) 36

## Speakers Option 36

## Standard-Definition Signal 24

## Standard Lamp Mode 39

## Stand Part Number 4

## Status Display 23

Stereo System. *See* A/V Receiver

## Surround Sound 53, 54

- Simulated Surround Sound 36
- TV Audio Outputs 16

## System Reset 9, 73

**T**

## Test Picture 33

## 3D GLASSES EMITTER Jack 16

## 3D Video 25, 34

Time. *See* Clock

## Timer (auto-on) 38

Time Zone. *See* Clock

## Troubleshooting 72

**U**

## USB Menu 29

**V**

## V-Chip Ratings

- Definitions 43
- In Status Display 23

## VCR

- Connecting 19
- Troubleshooting 76

## Video from a Digital Camera 30

Video Game. *See* Game

## Video Mute 33

Viewing Device. *See* Activity Menu**X**

## x.v.Color 16, 17, 35





**Website:**

[www.mitsubishi-tv.com](http://www.mitsubishi-tv.com)

**E-mail:**

[MDEAservice@mdea.com](mailto:MDEAservice@mdea.com)

**For questions, call Consumer Relations at**

**800-332-2119**

**To order replacement or additional  
remote controls or lamp cartridges,**

**Visit our website [www.mitsuparts.com](http://www.mitsuparts.com)**

**or call**

**800-553-7278**

**SYSTEM RESET**

If the TV does not respond to the remote control, control-panel buttons, or will not power on/off, press and hold the **POWER** button on the control panel for ten seconds.

The green LED will flash quickly for about one minute. When the green LED stops flashing, you may turn on the TV. Settings changes you made most recently, before using **SYSTEM RESET**, may be lost.