

marantz®

Model PD4220V User Guide

Plasma Monitor

Introduction

Introduction to the Plasma Monitor

Marantz's Plasma Monitor is a seamless blend of cutting-edge visual technology and sophisticated design. At each inch, with a 16:9 aspect ratio, the Plasma Monitor certainly makes a big impression. However, the monitor's sleek techno-art lines blend in well with your environment. Marantz Plasma Monitor's crisp, vivid image quality will transform data from any graphic medium from PCs to DVD players- into art. Marantz has made sure that a host of multimedia resources can be easily connected and displayed as brilliantly as intended on the Plasma Monitor.

The features you'll enjoy include:

- Color Filter and black matrix
- The enhanced display in red uses a two-stage filtering system.
- Flicker - and warp - free display provides excellent image geometry even in screen corners
- Not affected by magnetic fields, no color drift or edge distortion.
- VGA, SVGA, XGA, SXGA, UXGA computer signal compatibility
- NTSC, PAL, SECAM, composite and S-Video signal compatibility
- 480P, 1080I, 720P and HDTV signal compatibility
- PCs, VCRs, Laser Disc and DVD player source compatibility
- AccuBlend scan conversion automatically converts VGA, SVGA, XGA, SXGA and UXGA signals to the panel's native resolution.
- Advanced Mass Area Sampling Progressive Scan method is employed.
- RGB (3*), Video (3), DVD/HD (2*), Audio input (3), External Control input (1)
- AccuColor control system provides user selectable on-screen color temperature settings
- New Drive Technology
- Component video input terminal for DVD, 15.75kHz (Y, CB, CR)
- Digital broadcasting source compatibility
- OSM menu-driven on screen control system that makes image adjustments a snap
- Seven languages (English, German, French, Italian, Spanish, Swedish, and Chinese)

* You can set the 5BNC input to be used as an RGB or component input. When the 5BNC input is set for RGB, there are a total of three RGB inputs; when the 5BNC input is set for component there are a total of two DVD/HD inputs (see page 24).

Contents of the Package

- Plasma monitor
- Power cord
- Remote control with two AAA Batteries
- Manuals
- Safety metal fitting parts*
- Ferrite cores, bands
- Cable clamps

* Contents will differ according to the model.

* These are fittings for fastening the unit to a wall to prevent tipping due to external shock when using the stand (optional). Fasten the safety fittings to the holes in the back of the monitor using the safety fitting mount screws (see page 1).

Options

- Wall mount unit
- Stand

Important Information

Precautions

Please read this manual carefully before using your plasma monitor and keep the manual handy for future reference.

CAUTION



**RISK OF ELECTRIC SHOCK
DO NOT OPEN**



CAUTION: TO REDUCE THE RISK OF ELECTRIC SHOCK, DO NOT REMOVE COVER. NO USER-SERVICEABLE PARTS INSIDE. REFER SERVICING TO QUALIFIED SERVICE PERSONNEL.

 This symbol warns the user that uninsulated voltage within the unit may have sufficient magnitude to cause electric shock. Therefore, it is dangerous to make any kind of contact with any part inside of this unit.

 This symbol alerts the user that important literature concerning the operation and maintenance of this unit has been included. Therefore, it should be read carefully in order to avoid any problems.

WARNING

TO PREVENT FIRE OR SHOCK HAZARDS, DO NOT EXPOSE THIS UNIT TO RAIN OR MOISTURE. ALSO DO NOT USE THIS UNIT'S POLARIZED PLUG WITH AN EXTENSION CORD RECEPTACLE OR OTHER OUTLETS, UNLESS THE PRONGS CAN BE FULLY INSERTED. REFRAIN FROM OPENING THE CABINET AS THERE ARE HIGH-VOLTAGE COMPONENTS INSIDE. REFER SERVICING TO QUALIFIED SERVICE PERSONNEL.

Warnings and Safety Precaution

This plasma monitor is designed and manufactured to provide long, trouble-free service. No maintenance other than cleaning is required. Please see the section "Plasma monitor cleaning procedure" on the next page.

The plasma display panel consists of fine picture elements (cells) with more than 99.99 percent active cells. There may be some cells that do not produce light or remain lit.

For operating safety and to avoid damage to the unit, read carefully and observe the following instructions. To avoid shock and fire hazards:

1. Provide adequate space for ventilation to avoid internal heat build-up. Do not cover rear vents or install the unit in a closed cabinet or shelves.
If you install the unit in an enclosure, make sure there is adequate space at the top of the unit to allow hot air to rise and escape. If the monitor becomes too hot, the overheat protector will be activated and the monitor will be turned off. If this happens, turn off the power to the monitor and unplug the power cord. If the room where the monitor is installed is particularly hot, move the monitor to a cooler location, and wait for 60 minutes to cool the monitor. If the problem persists, contact your Marantz dealer for service.
2. Do not use this unit's polarized plug with extension cords or outlets unless the prongs can be completely inserted.
3. Do not expose the unit to water or moisture.
4. Avoid damage to the power cord, and do not attempt to modify the power cord.
5. Unplug the power cord during electrical storms or if the unit will not be used over a long period.
6. Do not open the cabinet which has potentially dangerous high voltage components inside. If the unit is damaged in this way the warranty will be void. Moreover, there is a serious risk of electric shock.
7. Do not attempt to service or repair the unit. The manufacturer is not liable for any bodily harm or damage caused if unqualified persons attempt service or open the back cover. Refer all service to authorized Marantz Service Centers.

To avoid damage and prolong operating life:

1. Use only with 120V 50/60Hz AC power supply. Continued operation at line voltages greater than 120 Volts AC will shorten the life of the unit, and might even cause a fire hazard.
2. Handle the unit carefully when installing it and do not drop.
3. Set the unit away from heat, excessive dust, and direct sunlight.
4. Protect the inside of the unit from liquids and small metal objects. In case of accident, unplug the power cord and have it serviced by an authorized Service Center.
5. Do not hit or scratch the panel surface as this causes flaws on the surface of the screen.
6. For correct installation and mounting it is strongly recommended to use a trained, authorized dealer.
7. As is the case with any phosphor-based display (like a CRT monitor, for example) light output will gradually decrease over the life of a Plasma Display Panel.
8. To avoid sulfurization it is strongly recommended not to place the unit in a dressing room in a public bath or hot spring bath.

Plasma monitor cleaning procedure:

1. Use a soft dry cloth to clean the front panel and bezel area. Never use solvents such as alcohol or thinner to clean these surfaces.
2. Clean plasma ventilation areas with a vacuum cleaner with a soft brush nozzle attachment.
3. To ensure proper ventilation, cleaning of the ventilation areas must be carried out monthly. More frequent cleaning may be necessary depending on the environment in which the plasma monitor is installed.

Recommendations to avoid or minimize phosphor burn-in:

Like all phosphor-based display devices and all other gas plasma displays, plasma monitors can be susceptible to phosphor burn under certain circumstances. Certain operating conditions, such as the continuous display of a static image over a prolonged period of time, can result in phosphor burn if proper precautions are not taken. To protect your investment in this plasma monitor, please adhere to the following guidelines and recommendations for minimizing the occurrence of image burn:

- * Always enable and use your computer's screen saver function during use with a computer input source.
- * Display a moving image whenever possible.
- * Change the position of the menu display from time to time.
- * Always power down the monitor when you are finished using it.

If the plasma monitor is in long term use or continuous operation take the following measures to reduce the likelihood of phosphor burn:

- * Lower the Brightness and Contrast levels as much as possible without impairing image readability.
- * Display an image with many colors and color gradations (i.e. photographic or photo-realistic images).
- * Create image content with minimal contrast between light and dark areas, for example white characters on black backgrounds. Use complementary or pastel color whenever possible.
- * Avoid displaying images with few colors and distinct, sharply defined borders between colors.

* **Note:** Burn-in is not covered by the warranty.

Contact Marantz Service Center for other recommended procedures that will best suit your particular application needs.

Recommandations importantes

Précautions

Veillez lire avec attention ce manuel avant d'utiliser le moniteur à plasma et le conserver accessible pour s'y référer ultérieurement.

ATTENTION



**RISQUE D'ELECTROCUTION
NE PAS OUVRIR**



MISE EN GARDE: AFIN DE REDUIRE LES RISQUES D'ELECTRO-CUTION, NE PAS DEPOSER LE COUVERCLE, IL N'Y A AUCUNE PIECE UTILISABLE A L'INTERIEUR DE CET APPAREIL. NE CONFIER LES TRAVAUX D'ENTRETIEN QU'A UN PERSONNEL QUALIFIE.

 Ce symbole a pour but de prévenir l'utilisateur de la présence d'une tension dangereuse, non isolée se trouvant à l'intérieur de l'appareil. Elle est d'une intensité suffisante pour constituer un risque d'électrocution. Eviter le contact avec les pièces à l'intérieur de cet appareil.

 Ce symbole a pour but de prévenir l'utilisateur de la présence d'importantes instructions concernant l'entretien et le fonctionnement de cet appareil. Par conséquent, elles doivent être lues attentivement afin d'éviter des problèmes.

AVERTISSEMENT

AFIN DE REDUIRE LES RISQUES D'INCENDIE OU D'ELECTROCUTION, NE PAS EXPOSER CET APPAREIL A LA PLUIE OU A L'HUMIDITE. AUSSI, NE PAS UTILISER LA FICHE POLARISEE AVEC UN PROLONGATEUR OU UNE AUTRE PRISE DE COURANT SAUF SI CES LAMES PEUVENT ETRE INSEREES A FOND. NE PAS OUVRIR LE COFFRET, DES COMPOSANTS HAUTE TENSION SE TROUVENT A L'INTERIEUR. LAISSER A UN PERSONNEL QUALIFIE LE SOIN DE REPARER CET APPAREIL.

Mises en garde et précautions de sécurité

Ce moniteur à plasma a été conçu et fabriqué pour une utilisation fiable et durable. Il ne nécessite aucun entretien en dehors du nettoyage. Voir la section "Méthode de nettoyage du moniteur à plasma" plus loin. Le panneau à affichage plasma est constitué de fines particules d'images (cellules) dont plus de 99,99% sont actives. Certaines d'entre elles ne produisent pas de lumière ou restent allumées.

Pour des raisons de sécurité et pour éviter d'endommager l'appareil, lire attentivement les instructions suivantes.

Pour éviter les risques d'électrocution et d'incendie:

1. Laisser suffisamment d'espace autour de l'appareil pour la ventilation et éviter toute augmentation excessive de la température interne. Ne pas couvrir les événements ou l'installer dans un endroit trop exigü.
Si vous installez l'appareil dans un espace clos, assurez-vous qu'il y ait suffisamment d'espace au dessus pour permettre à l'air chaud de s'élever et de s'évacuer. Si la température du moniteur devient excessive, la protection contre les surchauffes entrera en action et coupera l'alimentation. Dans ce cas, éteindre l'appareil et débrancher le câble d'alimentation. Si la température de la pièce dans laquelle se trouve le moniteur est particulièrement élevée, déplacer celui-ci dans un endroit plus frais et attendre environ 60 minutes qu'il refroidisse. Si le problème persiste, prendre contact avec le revendeur Marantz pour le service après-vente.
2. Ne pas raccorder la prise d'alimentation polarisée de ce périphérique à une rallonge ou une prise murale si les fiches ne peuvent pas être complètement insérées.
3. Ne pas exposer à l'eau ou à l'humidité.
4. Eviter d'endommager le cordon d'alimentation, et ne pas modifier le cordon d'alimentation.
5. Débrancher le câble d'alimentation électrique pendant les orages ou les longues périodes d'inactivité.
6. Ne pas ouvrir le coffret. Des composants de haute tension se trouvent à l'intérieur. Si l'appareil est endommagé de cette manière, la garantie devient caduque. De plus, il y a risque d'électrocution.
7. Ne pas essayer d'intervenir ou de réparer l'appareil. Le fabricant décline toute responsabilité en cas de blessure corporelle ou de dégâts matériels résultant d'une opération d'entretien quelconque effectuée par des personnes non qualifiées ou résultant de l'ouverture du couvercle arrière. Confier toute réparation à un centre de service agréé Marantz.

Pour éviter des dommages et prolonger la durée de service de l'appareil:

1. N'utiliser qu'une source d'alimentation de 120 V 50/60 Hz CA. Le fait d'utiliser l'appareil en continu à des tensions de ligne supérieures à 120 Volts CA réduit sa durée de vie et risque de provoquer un incendie.
2. Manipuler l'appareil avec soin pendant son déplacement et ne pas le faire tomber.
3. Eloigner l'appareil des endroits chauds, très poussiéreux et exposés en plein soleil.
4. Éviter que des liquides et des petits objets métalliques pénètrent à l'intérieur de l'appareil. En cas d'incident de ce genre, débrancher le câble d'alimentation électrique et confier le moniteur à un service après-vente agréé.
5. Ne pas frapper ou rayer la surface de la écran plasma, car des défauts risquent de se produire sur la surface de la écran plasma.
6. Pour un montage et une installation correcte, il est fortement recommandé de faire appel à un revendeur agréé et qualifié.
7. Comme c'est le cas pour tout affichage à base de phosphore (comme un moniteur CRT, par exemple), la puissance de lumière baisse graduellement au cours de la vie du Panneau d'Affichage à Plasma.
8. Pour éviter tout risque de sulfuration, il est fortement conseillé de ne pas installer l'appareil dans un vestiaire, un bain public ou un bain de source thermale.

Méthode de nettoyage du moniteur à plasma:

1. Nettoyer le panneau avant et le cadre en procédant à l'aide d'un chiffon doux et sec. Ne jamais utiliser de solvants du type alcool ou diluant pour le nettoyage de ces surfaces.
2. Nettoyer les prises d'aération du plasma en procédant à l'aide d'une brosse à poils doux fixée à un aspirateur.
3. Pour garantir la bonne ventilation du moniteur, nettoyer les prises d'air tous les mois. Un nettoyage plus fréquent peut s'avérer nécessaire selon les conditions environnementales dans lesquelles le moniteur à plasma est utilisé.

Pour éviter les risques de brûlage du luminophore, les mesures suivantes sont recommandées:

Comme tous les périphériques d'affichage à base luminophore et tous les autres affichages gaz plasma, les moniteurs plasma peuvent être sujets au brûlage du luminophore dans certaines circonstances. Certaines conditions d'utilisation, telles que l'affichage continu d'une image statique pour une durée prolongée, peuvent causer le brûlage du luminophore si aucune précaution n'est prise. Pour protéger votre investissement dans ce moniteur à plasma, veuillez suivre les directives et les conseils suivantes pour minimiser l'occurrence le marquage de l'écran:

- Assurez-vous de mettre en marche et d'utiliser l'économisateur d'écran chaque fois que c'est possible lorsque vous l'utilisez avec une source d'entrée d'ordinateur.
- Affichez une image en mouvement aussi souvent que possible.
- Changez la position de l'affichage de menu de temps à autre.
- Coupez toujours l'alimentation lorsque vous avez terminé d'utiliser le moniteur.

Si le moniteur est en usage continu ou longue durée, prenez les mesures suivantes afin d'éviter l'occurrence le brûlage du luminophore:

- Abaissez le niveau de l'image (contraste, luminosité) autant que possible, sans faire perdre la lisibilité de l'image.
- Affichez une image avec de nombreuses couleurs et graduations de couleur (par ex. des images photographiques ou photo-réalistes).
- Créez un contenu d'image avec un contraste minimal entre les zones sombres et les zones claires, par exemple, des caractères blancs sur un fond noir. Utilisez des couleurs complémentaires ou pastels le plus souvent possible.
- Évitez d'afficher des images avec peu de couleurs et des limites nettes et clairement définies entre les couleurs.

* **Remarque:** Le brûlage de l'écran n'est pas couvert par la garantie.

Contactez Marantz Service Center pour d'autres procédures recommandées qui conviendront le mieux au besoin de votre appareil.

Contents

How to Attach Options to the Plasma Monitor 1

- Ventilation Requirements for enclosure mounting 1
- How to use the safety metal fittings and the screws for safety metal fittings 1

Part Names and Function 2

- Front View 2
- Rear View / Terminal Board 3
- Remote Control 4
 - Battery Installation and Replacement 5
 - Using the wired remote control mode 6
 - Operating Range 6
 - Handling the remote control 6

Installation 7

- Connecting Your PC or Macintosh Computer 8
- Connections with Equipment that have a Digital Interface 8
- Connecting Your Document Camera 8
- Connecting Your VCR or Laser Disc Player 8
- Connecting Your DVD Player 8
- Pin Assignments and Signal Levels
 - for 15 pin RGB (Analog) 9
- Pin Configuration and Signal Levels
 - of the RGB 3 Connector (DVI Connector) 9
- Creating a video wall 10
- Cable Management 10

Basic Operations 11

- POWER 11
 - To turn the unit ON and OFF: 11
- VOLUME 11
 - To adjust the sound volume: 11
- MUTE 11
 - To cancel the sound: 11
- DISPLAY 11
 - To check the settings: 11
- DIGITAL ZOOM 11
- AUTO ADJUST 11
 - To adjust the size or quality of the picture automatically 11
- OFF TIMER 12
 - To set the off timer: 12
 - To check the remaining time: 12
 - To cancel the off timer: 12

WIDE Operations 13

- Wide Screen Operation (manual) 13
 - When viewing videos or digital video discs 13
- Wide Screen Operation with Computer Signals 14
 - When "PICTURE SIZE" is set to "OFF" 14

OSM Controls 15

- Menu Operations 15
- Menu Tree 16
- Picture Settings Menu 18
 - Adjusting the picture 18
 - Setting the picture mode according to the brightness of the room 18
 - Reducing noise in the picture 19
 - Setting the color temperature 19
 - Adjusting the color to the desired level 19
 - Changing the Gamma Curve 20
 - Making the Low Tone adjustments 20
 - Adjusting the colors 21
- Audio Settings Menu 21
 - Adjusting the treble, bass and left/right balance and audio input select 21
 - Setting the allocation of the audio connectors 22

- Image Adjust Settings Menu 22
 - Adjusting the Position, Size, Fine Picture, Picture Adj 22
- Option1 Settings Menu 23
 - Setting the on-screen menu 23
 - Setting the BNC connectors 24
 - Checking the signal being transmitted to RGB1 terminal 24
 - Setting a computer image to the correct RGB select screen 24
 - Setting high definition images to the suitable screen size 25
 - Setting the Input Skip 25
 - Resetting to the default values 26
- Option2 Settings Menu 26
 - Setting the power management for computer images 26
 - POWER/STANDBY indicator 27
 - Setting the picture to suit the movie 27
 - Reducing burn-in of the screen 27
 - Setting the gray level for the sides of the screen 30
 - Setting the screen size for S1/S2 video input 30
 - Setting the picture size for RGB input signals 31
 - Setting the signal and black level for DVI signal 31
- Option3 Settings Menu 32
 - Using the timer 32
 - Setting the power on mode 33
 - Enabling/disabling the front panel controls 34
 - Enabling/disabling remote control wireless transmission 34
 - Loop Out setting 35
 - ID number setting 35
 - Video Wall setting 36
- Advanced OSM Settings Menu 39
 - Setting the menu mode 39
- Language Settings Menu 40
 - Setting the language for the menus 40
- Color System Settings Menu 40
 - Setting the video signal format 40
- Source Information Menu 40
 - Checking the frequencies, polarities of input signals, and resolution 40

External Control 41

Troubleshooting 42

How to Attach Options to the Plasma Monitor

You can attach your optional mounts or stand to the plasma monitor in one of the following two ways:

- * While it is upright. (See Drawing A)
- * As it is laid down with the screen face down (See Drawing B). Lay the protective sheet, which was wrapped around the monitor when it was packaged, beneath the screen surface so as not to scratch the screen face.
- * Do not touch or hold the screen face when carrying the unit.

- **This device cannot be installed on its own. Be sure to use a stand or original mounting unit. (Wall mount unit, Stand, etc.)**
- * **See the inside of the cover page.**
- **For correct installation and mounting it is strongly recommended to use a trained, authorized dealer.**
Failure to follow correct mounting procedures could result in damage to the equipment or injury to the installer.
Product warranty does not cover damage caused by improper installation.

* Use only the mounting kit or stand provided by manufacturer and listed under Options.

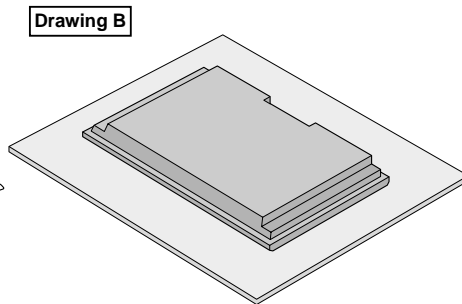
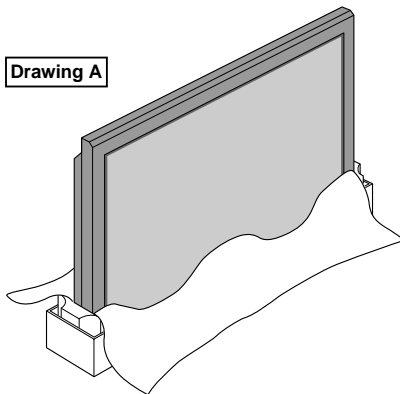

Some models are equipped with handles.
 When installing or carrying, use the handles attached to the upper back of the display.



Ventilation Requirements for enclosure mounting

To allow heat to disperse, leave space between surrounding objects as shown on the diagram below when installing.

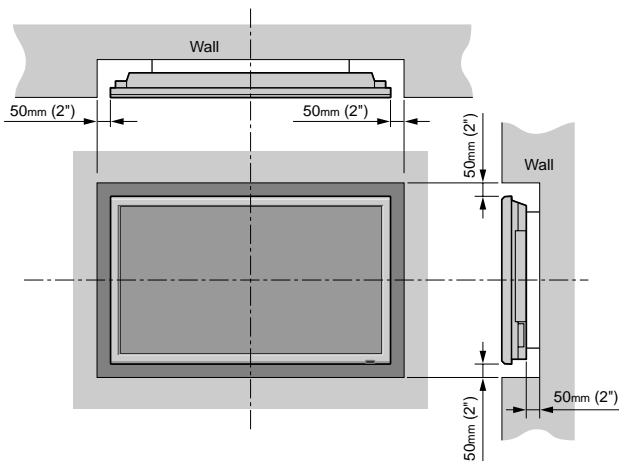

How to use the safety metal fittings and the screws for safety metal fittings

These are fittings for fastening the unit to a wall to prevent tipping due to external shock when using the stand (optional). Fasten the safety fittings to the holes in the back of the monitor using the safety fitting mount screws.
 * Safety metal fittings will differ according to the model.

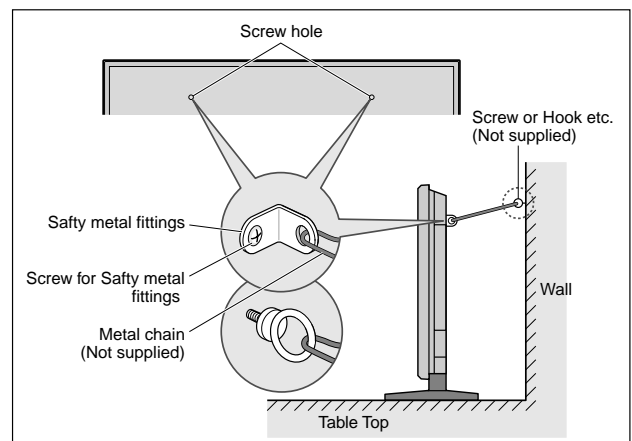

Part Names and Function

Front View

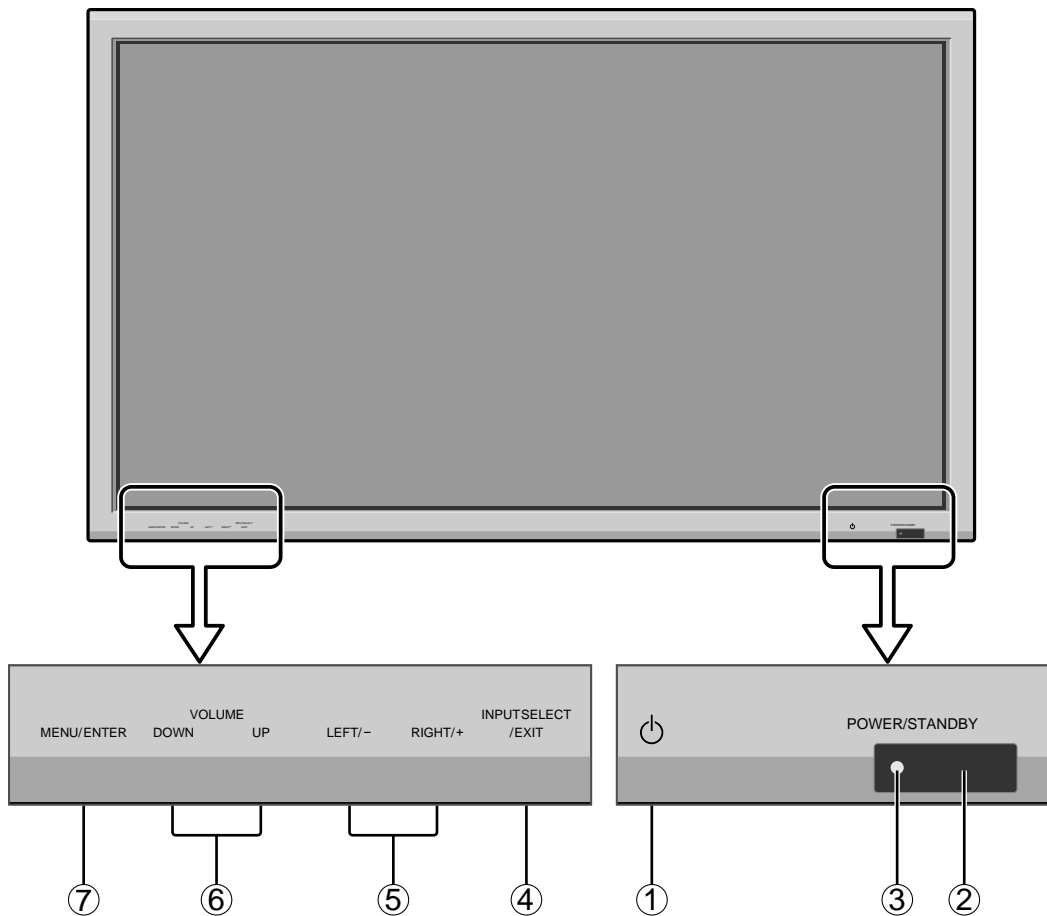

- ① **Power**
Turns the monitor's power on and off.
- ② **Remote sensor window**
Receives the signals from the remote control.
- ③ **POWER/STANDBY indicator**
When the power is on Lights green.
When the power is in the standby mode ... Lights red.
* POWER/STANDBY letter is printed on model PD6140 and PD5040 only.
- ④ **INPUT SELECT / EXIT**
Switches the input, in the following order.
The available inputs depend on the setting of "BNC INPUT".
RGB: → VIDEO1 → VIDEO2 → VIDEO3 → HD/DVD/DTV →
RGB/PC3 ← RGB/PC2 ← RGB/PC1 ←
COMP.: → VIDEO1 → VIDEO2 → VIDEO3 → HD1/DVD1/DTV1 →
RGB/PC2 ← RGB/PC1 ← HD2/DVD2/DTV2 ←

Functions as the EXIT buttons in the On-Screen Menu (OSM) mode.
- ⑤ **LEFT/- and RIGHT/+**
Enlarges or reduces the image. Functions as the CURSOR (◀/▶) buttons in the On-Screen Menu (OSM) mode.
- ⑥ **VOLUME DOWN and UP**
Adjusts the volume. Functions as the CURSOR (▲/▼) buttons in the On-Screen Menu (OSM) mode.
- ⑦ **MENU/ENTER**
Sets the On-Screen Menu (OSM) mode and displays the main menu.

Rear View/ Terminal Board

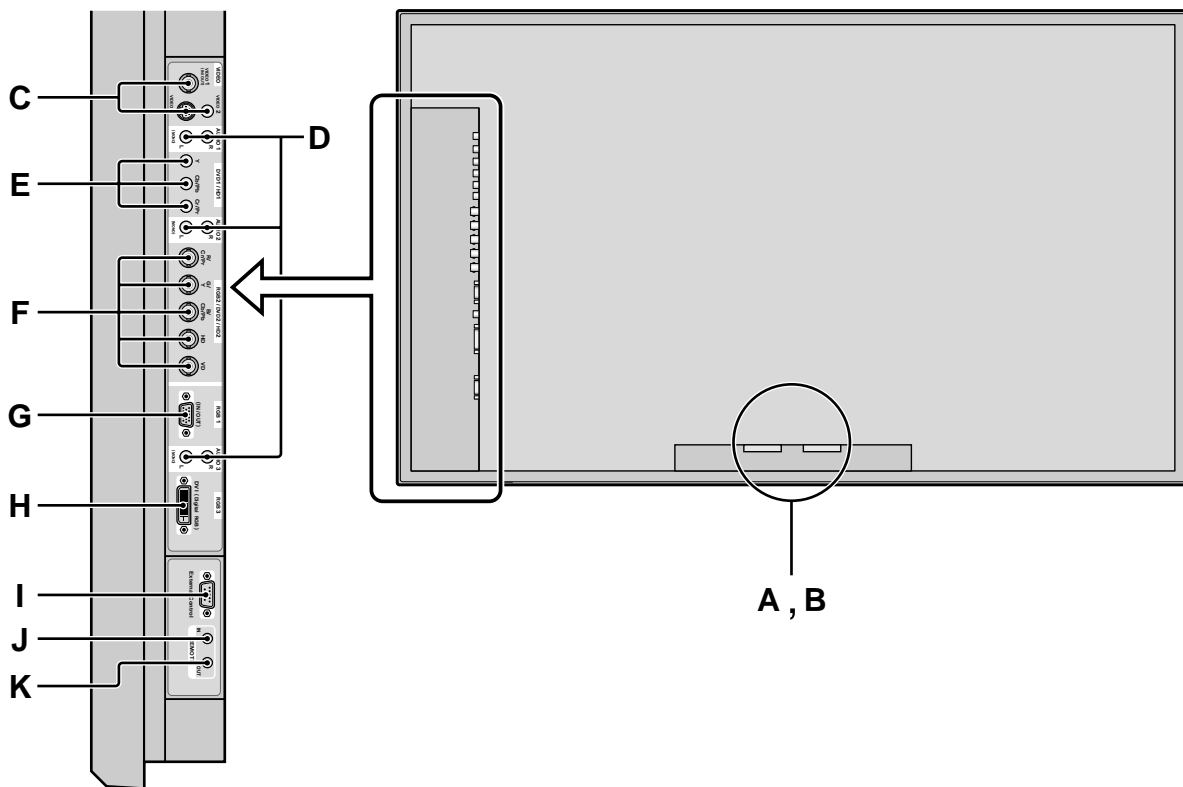

A AC IN

Connect the included power cord here.

B EXT SPEAKER L and R

Connect speakers (optional) here. Maintain the correct polarity. Connect the \oplus (positive) speaker wire to the \oplus EXT SPEAKER terminal and the \ominus (negative) speaker wire to the \ominus EXT SPEAKER terminal on both LEFT and RIGHT channels.

Please refer to your speaker's owner's manual.

C VIDEO1, 2, 3 (BNC, RCA, S-Video)

Connect VCR's, DVD's or Video Cameras, etc. here. VIDEO1 can be used for Input or Output (see page 10).

D AUDIO1, AUDIO2, AUDIO3

These are audio input terminals.

The input is selectable. Set which video image to allot them from the audio menu screen.

E DVD1 / HD1

Connect DVD's, High Definition or Laser Discs, etc. here.

F RGB2/ DVD2/ HD2

RGB2: You can connect an analog RGB signal and the synchronization signal.

DVD2/ HD2: You can connect DVDs, High Definition sources, Laser Discs, etc. here.

This input can be set for use with an RGB or component source. (see page 24)

G RGB1 (mini D-Sub 15pin)

Connect an analog RGB signal from a computer, etc. here. This input can be used for Input or Output. (see page 10)

H RGB3 (DVI 24pin)

Connect a digital signal (TMDS) from a source with a DVI output. (see page 8)

I EXTERNAL CONTROL

This terminal is used when operating and controlling the monitor externally (by external control).

J REMOTE IN

Connect the remote cable* to the remote control's remote jack to obtain wired remote control.

K REMOTE OUT

Connect the remote cable* to the REMOTE IN jack of the other display monitor to obtain wired remote control.

* The 1/8 Stereo Mini cable must be purchased separately.

Remote Control

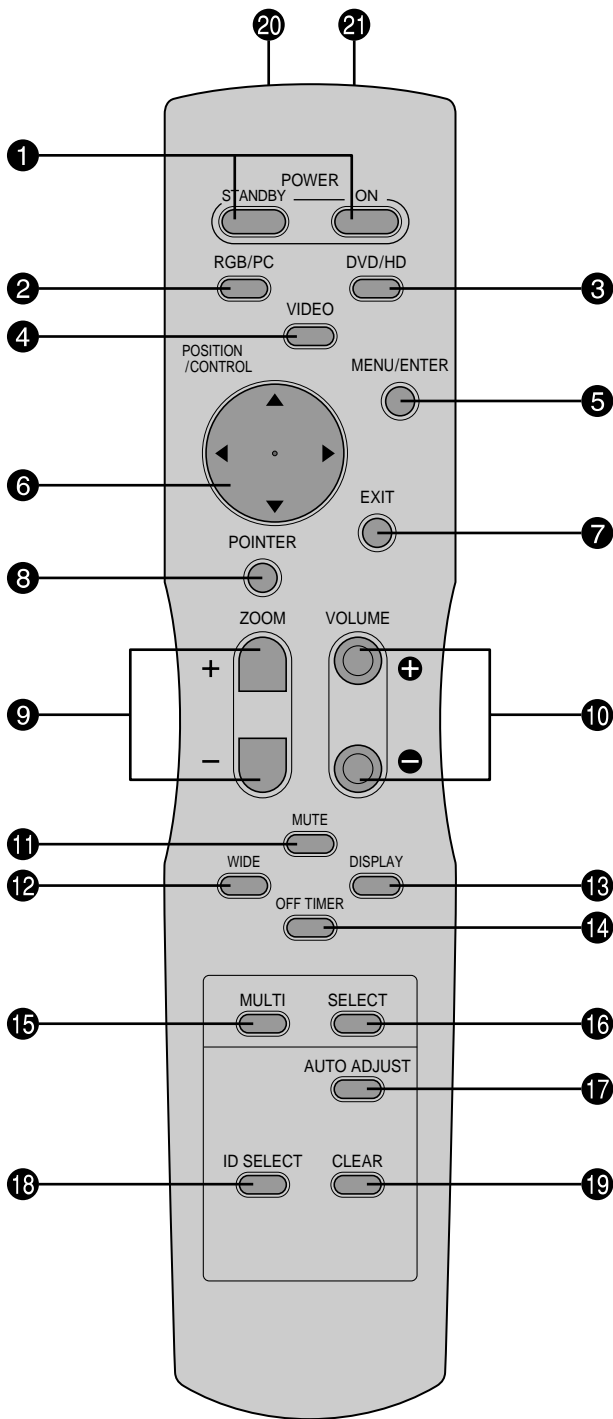

1 POWER ON/STANDBY

Switches the power on/standby.
(This does not operate when POWER/STANDBY indicator of the main unit is off.)

2 RGB/PC

Press this button to select RGB/PC as the source.
The available sources depend on the setting of "BNC INPUT".

RGB: → RGB/PC1 → RGB/PC2 → RGB/PC3

COMP.: → RGB/PC1 → RGB/PC3

RGB/PC can also be selected using the INPUT SELECT button on the monitor.

3 DVD / HD

Press this button to select DVD/HD as the source.
The available sources depend on the setting of "BNC INPUT".

RGB: HD/DVD/DTV

COMP.: → HD1/DVD1/DTV1 → HD2/DVD2/DTV2

DVD/HD can also be selected using the INPUT SELECT button on the monitor.

4 VIDEO

Press this button to select VIDEO as the source.

→ VIDEO1 → VIDEO2 → VIDEO3

VIDEO can also be selected using the INPUT SELECT button on the monitor.

5 MENU/ENTER

Press this button to access the OSM controls.
Press this button during the display of the main menu to go to the sub menu.

6 CURSOR (▲ / ▼ / ◀ / ▶)

Use these buttons to select items or settings and to adjust settings or switch the display patterns.

7 EXIT

Press this button to exit the OSM controls in the main menu. Press this button during the display of the sub menu to return to the previous menu.

8 POINTER

Press this button to display the pointer.

9 ZOOM (+ / -)

Enlarges or reduces the image.

10 VOLUME (+ / -)

Adjusts the audio volume.

11 MUTE

Mutes the sound.

12 WIDE

Automatically detects the signal and sets the aspect ratio.
Wide button is not active for all signals.

13 DISPLAY

Displays the source settings on the screen.

14 OFF TIMER

Activates the off timer for the unit.

15 MULTI

Not functional for the models covered in this manual.

16 SELECT

Not functional for the models covered in this manual.

17 AUTO ADJUST

Press this button to adjust Fine Picture, Picture ADJ, Position, and Contrast automatically, or to switch the screen size to ZOOM mode automatically with the superimposed caption displayed fully only when the picture contains dark areas above and below the picture.

18 ID SELECT

Set the ID number in the remote control. The remote control can then be used only for a display with the same ID number. When several displays are used together they can be controlled individually.

19 CLEAR

Clears the number set by the ID SELECT button.

20 Remote control signal transmitter

Transmits the remote control signals.

21 Remote Jack

Insert the plug of the remote cable (The 1/8 Stereo Mini cable) here when using the supplied remote control in the wired condition.

Battery Installation and Replacement

Insert the 2 “AAA” batteries, making sure to set them in with the proper polarity.

1. Press and open the cover.

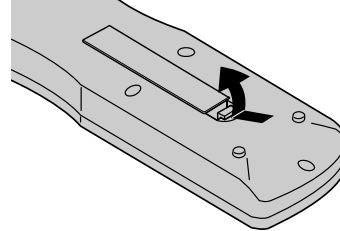

2. Align the batteries according to the (+) and (-) indication inside the case.

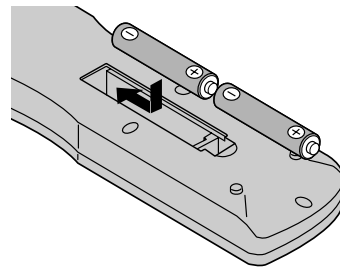

3. Replace the cover.

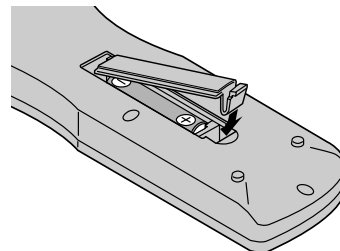

Using the wired remote control mode

Connect the remote cable* to the remote control's remote jack and the "REMOTE IN" terminal on the monitor. When the cable is connected, the mode automatically switches to wired remote control. When the wired remote control mode is used, the remote control can be operated even if no batteries are loaded.

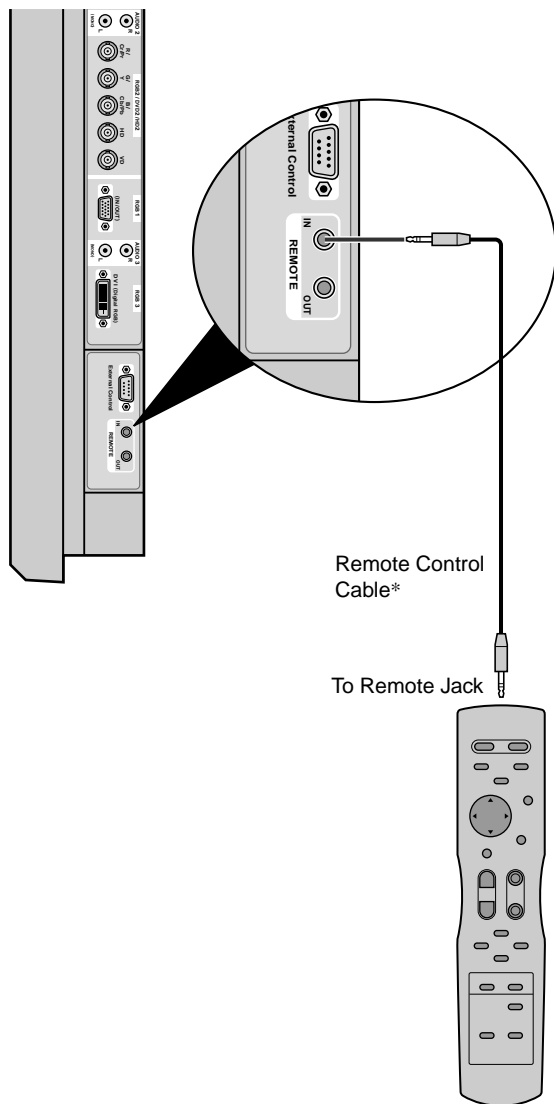

* The 1/8 Stereo Mini cable must be purchased separately.

Operating Range

- * Use the remote control within a distance of about 7 m/ 23ft. from the front of the monitor's remote control sensor and at horizontal and vertical angles of up to approximately 30°.
- * The remote control operation may not function if the monitor's remote control sensor is exposed to direct sunlight or strong artificial light, or if there is an obstacle between the sensor and the remote control.

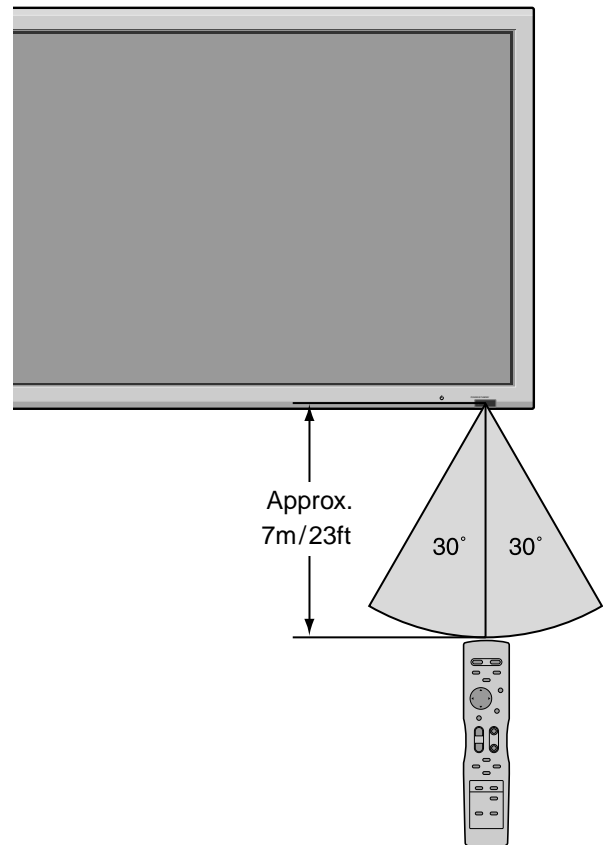

Handling the remote control

- Do not drop or mishandle the remote control.
- Do not get the remote control wet. If the remote control gets wet, wipe it dry immediately.
- Avoid heat and humidity.
- When not using the remote control for a long period, remove the batteries.
- Do not use new and old batteries together, or use different types together.
- Do not take apart the batteries, heat them, or throw them into a fire.
- When using the remote control in the wireless condition, be sure to unplug the remote cable from the REMOTE IN terminal on the monitor.

Installation

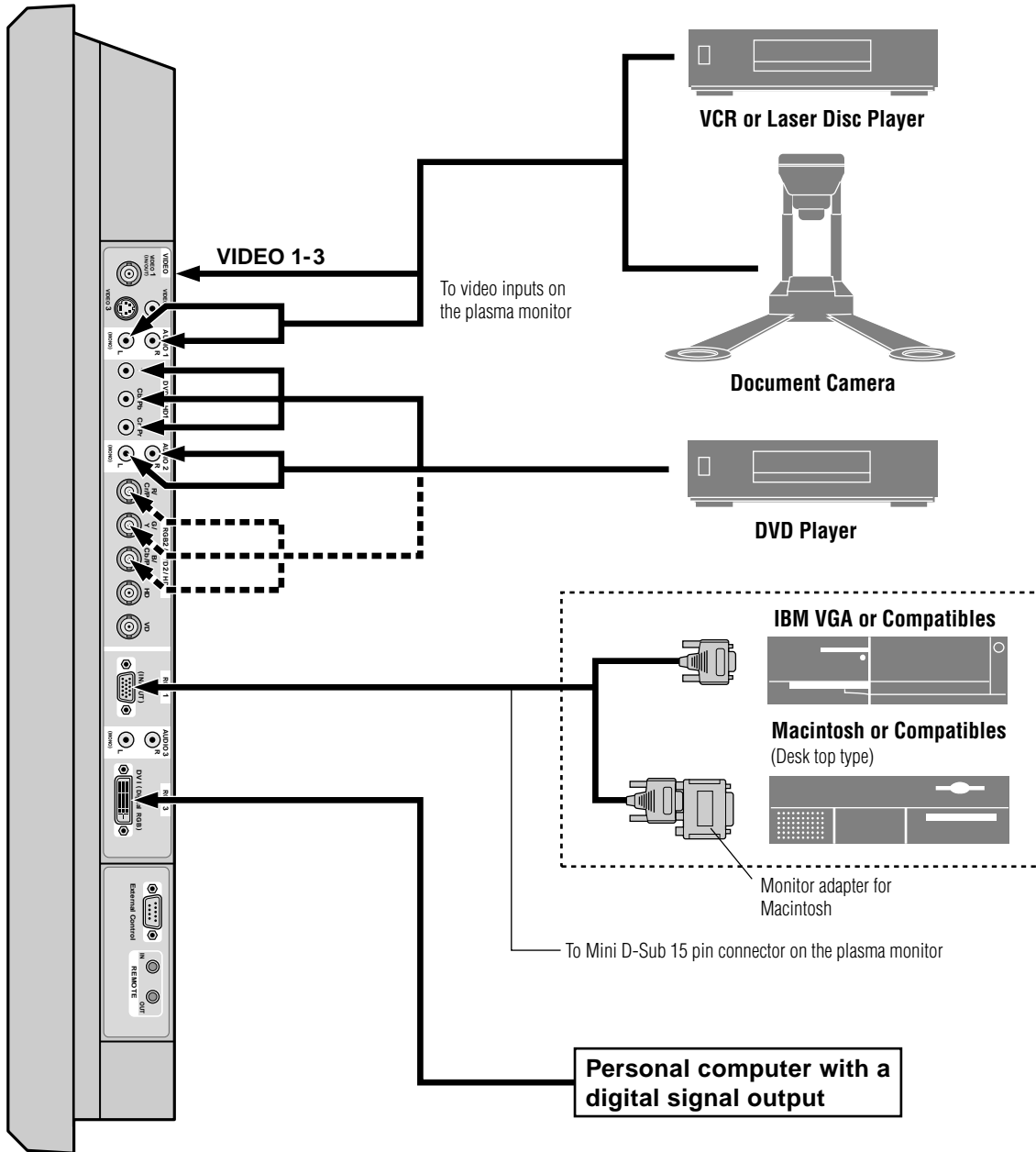

Connecting Your PC or Macintosh Computer

Connecting your PC or Macintosh computer to your plasma monitor will enable you to display your computer's screen image for an impressive presentation. The plasma monitor supports the signals described on page 7 of Model Information.

To connect a PC, Macintosh or compatible graphics adapter, simply:

1. Turn off the power to your plasma monitor and computer.
2. If your PC does not support SXGA/XGA/SVGA/VGA you will need to install an SXGA/XGA/SVGA/VGA graphics board. Consult your computer's owner's manual for your SXGA/XGA/SVGA/VGA configuration. If you need to install a new board, see the manual that comes with your new graphics board for installation instructions.
3. This plasma monitor provides signal compatibility up to VESA 1600 × 1200 (UXGA). However, it is not recommended to use this resolution due to image readability on the monitor's native pixel resolution panel.
4. Use the signal cable to connect your PC or Macintosh computer to the plasma monitor. For Macintosh, use the monitor adapter to connect to your computer's video port, if necessary.
5. Turn on the plasma monitor and the computer.
6. If the plasma monitor goes blank after a period of inactivity, it may be caused by a screen saver installed on the computer you've connected to the plasma monitor.

When using a Macintosh with the plasma monitor, the following four display standards are supported using the Macintosh adapter :

- 13" fixed mode
- 16" fixed mode
- 19" fixed mode
- 21" fixed mode

The 19" fixed mode is recommended for your monitor.

Connections with Equipment that have a Digital Interface

Connections can be made with equipment that is equipped with a digital interface compliant with the DVI (Digital Visual Interface) standard.

- * Use a DVI 24-pin signal cable and the ferrite cores (supplied) when making connections to the RGB3 (DVI) connector of the main unit.

Note that the RGB3 (DVI) terminal does not support analog RGB input source.

Note:

1. Input TMDS signals conforming to DVI standards. The TMDS input corresponds to 1 link.
2. To maintain display quality, use a cable with a quality prescribed by DVI standards that is within 5 meters in length.

Connecting Your Document Camera

You can connect your plasma monitor to a document camera. To do so, simply:

1. Turn off the power to your plasma monitor and document camera.
2. Use a standard video cable to connect your document camera to the Video input on your plasma monitor.
3. Turn on the plasma monitor and the document camera.

Note: Refer to your document camera owner's manual for more information about your camera's video output requirements.

Connecting Your VCR or Laser Disc Player

Use common RCA cables (not provided) to connect your VCR or laser disc player to your plasma monitor. To make these connections, simply:

1. Turn off the power to your plasma monitor and VCR or laser disc player.
2. Connect one end of your RCA cable to the video output connector on the back of your VCR or laser disc player, connect the other end to the Video input on your plasma monitor. Use standard RCA audio patch cords to connect the audio from your VCR or laser disc player to your plasma monitor (if your VCR or laser disc player has this capability). Be careful to keep your right and left channel connections correct for stereo sound.
3. Turn on the plasma monitor and the VCR or laser disc player.

Note: Refer to your VCR or laser disc player owner's manual for more information about your equipment's video output requirements.

Connecting Your DVD Player

You can connect your plasma monitor to a DVD player. To do so, simply:

1. Turn off the power to your plasma monitor and DVD player.
2. Use a component video cable to connect your DVD player to the Y, Cb, and Cr inputs on your plasma monitor.
Or use the DVD-player's S-Video output. Use a standard S-Video cable to connect to the S-Video input on the plasma monitor.
3. Turn on the plasma monitor and the DVD player.

Pin Assignments and Signal Levels for 15 pin RGB (Analog)

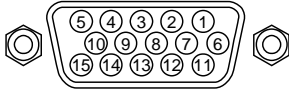

Pin No.	Signal (Analog)
1	Red
2	Green or sync-on-green
3	Blue
4	No connection
5	Ground
6	Red ground
7	Green ground
8	Blue ground
9	No connection
10	Sync signal ground
11	No connection
12	Bi-directional DATA (SDA)
13	Horizontal sync or Composite sync
14	Vertical sync
15	Data clock

Pin Configuration and Signal of the RGB 3 Connector (DVI Connector)

The unit is equipped with a type of connector commonly used for digital.

(This cannot be used for an analog input.)

(TMDS can be used for one link only.)

RGB 3

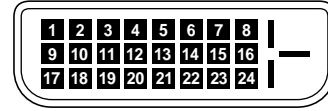

Pin No.	Signal (Digital)
1	T.M.D.S Data 2 -
2	T.M.D.S Data 2 +
3	T.M.D.S Data 2 Shield
4	No connection
5	No connection
6	DDC Clock
7	DDC Data
8	No connection
9	T.M.D.S Data 1 -
10	T.M.D.S Data 1 +
11	T.M.D.S Data 1 Shield
12	No connection
13	No connection
14	+5V Power
15	Ground
16	Hot Plug Detect
17	T.M.D.S Data 0 -
18	T.M.D.S Data 0 +
19	T.M.D.S Data 0 Shield
20	No connection
21	No connection
22	T.M.D.S Clock Shield
23	T.M.D.S Clock +
24	T.M.D.S Clock -

Creating a video wall

With built-in matrix display capability, you can create a 2x2 or 3x3 video wall.

- Connect signal cables and remote cables as shown below.

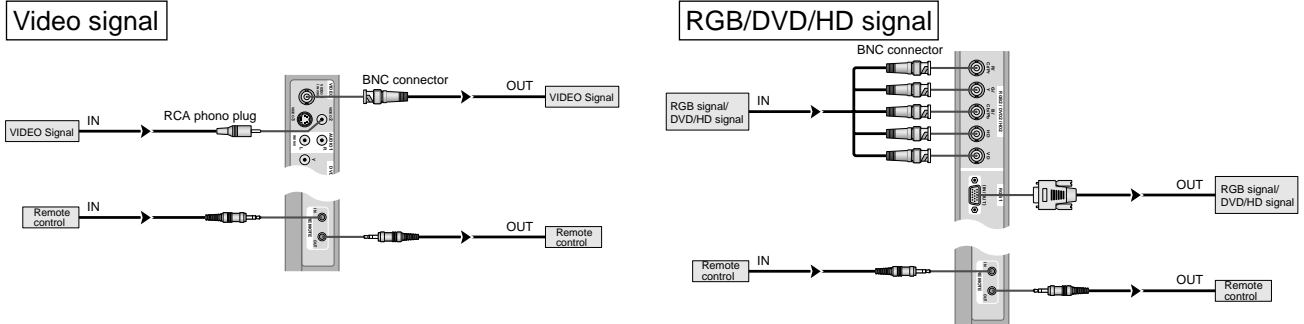

Note:

1. The VIDEO1 and RGB1 terminals can be used for either INPUT or OUTPUT. When LOOP OUT is ON, do not connect an OUTPUT signal from another unit, that will place an extraordinary load on the other unit and may damage it.
2. LOOP OUT can not be turned ON while signals are input to RGB1 terminal.
3. LOOP OUT can be turned ON while signals are input to RGB1 terminal if the POWER is switched ON.

Information

- To loop signals out to another plasma display, set the LOOP OUT to ON.
- To create a video wall, set the VIDEO WALL menu items properly.
- To connect monitors, please use a 1~2m (3.3~6.6 feet) BNC cable (any commercially available cable).
- If the image quality is poor, do not use the monitor's out terminal. Use a distribution amplifier (any commercially available distribution amplifier) to connect the split signals to the respective monitor INPUT terminals.
- Being used as a video wall function, maximally 4-screen is rough-standard with lower than 1024x768, 60Hz signal.
- A distribution amplifier is particularly recommended when using a 9-screen video wall.
- From the second monitor onward, connections require a BNC-RCA conversion cable or connector, a mini D-Sub 15 pin cable-BNC (x5) cable or a conversion connector.

Cable Management

Using the cable clamps provided with the plasma display, bundle at the back of the unit the signal and audio cables connected to the display.

* The cable clamp will differ according to the model.

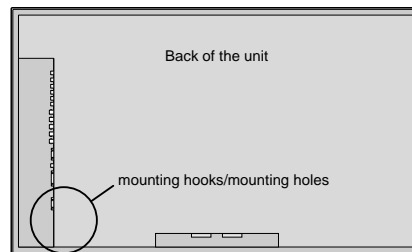

To attach

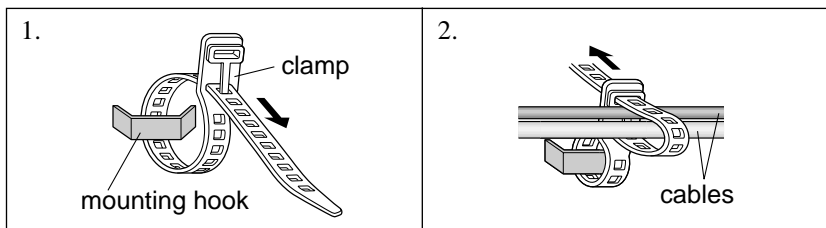

To detach

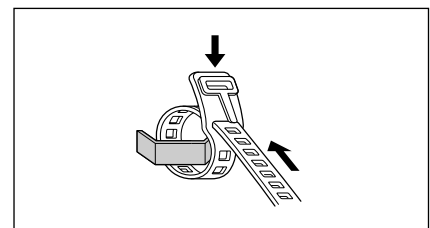

To attach

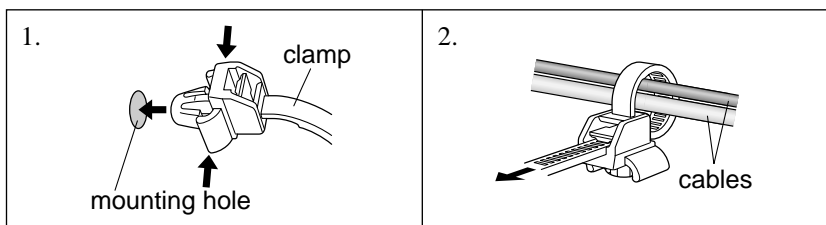

To detach

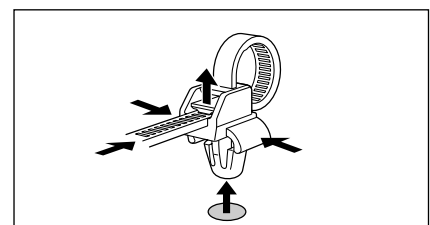

Basic Operations

POWER

To turn the unit ON and OFF:

1. Plug the power cord into an active AC power outlet.
2. Press the Power button (on the unit).
The monitor's POWER/STANDBY indicator turns red and the standby mode is set.
3. Press the POWER ON button (on the remote control) to turn on the unit.
The monitor's POWER/STANDBY indicator will light up (green) when the unit is on.
4. Press the POWER STANDBY button (on the remote control) or the Power button (on the unit) to turn off the unit.
The monitor's POWER/STANDBY indicator turns red and the standby mode is set (only when turning off the unit with the remote control).

VOLUME

To adjust the sound volume:

1. Press and hold the VOLUME ⊕ button (on the remote control or the unit) to increase to the desired level.
2. Press and hold the VOLUME ⊖ button (on the remote control or the unit) to decrease to the desired level.

MUTE

To cancel the sound:

Press the MUTE button on the remote control to cancel the sound; press again to restore.

DISPLAY

To check the settings:

1. The screen changes each time the DISPLAY button is pressed.
2. If the button is not pressed for approximately three seconds, the menu turns off.

DIGITAL ZOOM

Digital zoom specifies the picture position and enlarges the picture.

1. Press the POINTER button to display the pointer. ()

To change the size of the picture:

Press the ZOOM+ button and enlarge the picture.

The pointer will change to resemble a magnifying glass. ()

A press of the ZOOM- button will reduce the picture and return it to its original size.

To change the picture position:

Select the position with the ▲▼◀▶ buttons.

2. Press the POINTER button to delete the pointer.

AUTO ADJUST

To adjust the size or quality of the picture automatically:

Press the AUTO ADJUST button.

Information

■ AUTO ADJUST ON setting

When RGB (still picture) input is selected Fine Picture, Picture ADJ, Position, and Contrast will be adjusted automatically.

When RGB (motion picture), VIDEO, or Y/Pb/Pr (component) input is selected The screen size switches to ZOOM mode automatically with the superimposed caption displayed fully only when the picture contains dark areas above and below the picture.

OFF TIMER

To set the off timer:

The off timer can be set to turn the power off after 30, 60, 90 or 120 minutes.

1. Press the OFF TIMER button to start the timer at 30 minutes.
2. Press the OFF TIMER button to the desired time.
3. The timer starts when the menu turns off.

→ 30 → 60 → 90 → 120 → 0

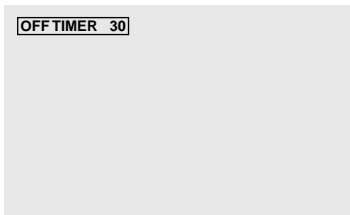

To check the remaining time:

1. Once the off timer has been set, press the OFF TIMER button once.
2. The remaining time is displayed, then turns off after a few seconds.
3. When five minutes remain the remaining time appears until it reaches zero.



To cancel the off timer:

1. Press the OFF TIMER button twice in a row.
2. The off timer is canceled.



Note:

After the power is turned off with the off timer ... A slight current is still supplied to the monitor. When you are leaving the room or do not plan to use the system for a long period of time, turn off the power of the monitor.

WIDE Operations

Wide Screen Operation (manual)

With this function, you can select one of six screen sizes.

When viewing videos or digital video discs

1. Press the WIDE button on the remote control.
2. *Within 3 seconds ...*

Press the WIDE button again.

The screen size switches as follows:

→ NORMAL → FULL → STADIUM → ZOOM → 2.35:1 → 14:9

When a 720P or 1080I signal is input:

FULL ↔ 2.35:1

NORMAL size screen (4:3)

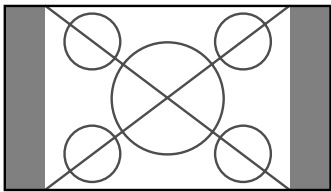

The normal size screen is displayed.

- * The picture has the same size as video pictures with a 4 : 3 aspect ratio.

FULL size screen

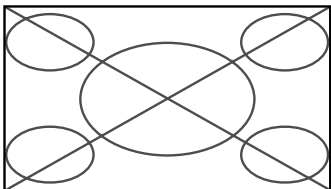

The image is expanded in the horizontal direction.

- * Images compressed in the horizontal direction ("squeezed images") are expanded in the horizontal direction and displayed on the entire screen with correct linearity. (Normal images are expanded in the horizontal direction.)

STADIUM size screen

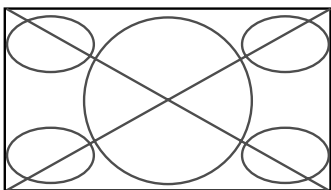

The picture is expanded in the horizontal and vertical directions at different ratios.

- * Use this for watching normal video programs (4:3) with a wide screen.

ZOOM size screen

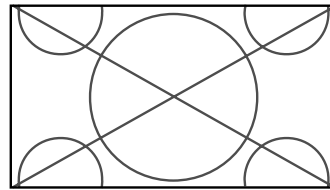

The picture is expanded in the horizontal and vertical direction, maintaining the original proportions.

- * Use this for theater size (wide) movies, etc.

2.35:1 size screen

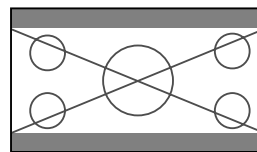

Original image

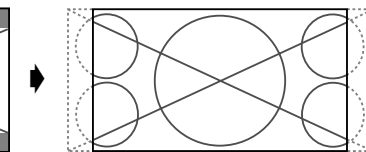

Information is lost on both sides.

The squeezed film image is expanded to fulfill the entire screen at a ratio of 2.35:1. Black bands do not appear at the top and bottom but information is lost on the left and right margins.

- This feature is available when the input signal is video, component (480I, 480P, 576I, 576P, 720P, 1080I) or RGB (525P or 625P signal from a scan converter).
- * If black bands appear on the top and bottom in the full size screen, select the 2.35:1 size screen to avoid phosphor burn-in.

14:9 size screen

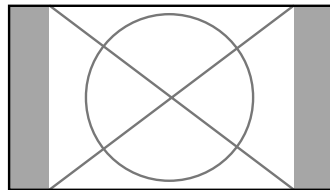

The image is displayed at a 14:9 aspect ratio.

- * This feature is available when the input signal is video, component (480I, 480P, 576I, 576P) or RGB (525P or 625P signal from a scan converter).

Note:

Do not allow the displayed in 4:3 mode for an extended period. This can cause a phosphor burn-in.

Wide Screen Operation with Computer Signals

Switch to the wide screen mode to expand the 4 : 3 image to fill the entire screen.

1. Press the WIDE button on the remote control.
2. *Within 3 seconds ...*

Press the WIDE button again.
The screen size switches as follows:

→ NORMAL → FULL → ZOOM

NORMAL size screen (4:3 or SXGA 5:4)

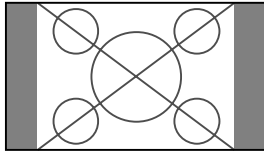

The picture has the same size as the normal computer image.

FULL size screen

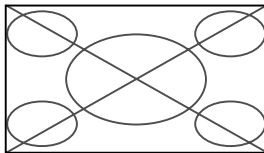

The image is expanded in the horizontal direction.

ZOOM size screen

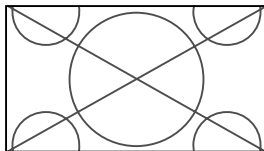

When wide signals are input.

FULL size screen

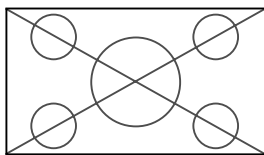

When "PICTURE SIZE" is set to "OFF"

* This cannot be set in some models. "TRUE size" will not be displayed in such cases.

The screen size switches as follows:

→ TRUE → FULL → ZOOM

TRUE size screen (VGA, SVGA 4:3)

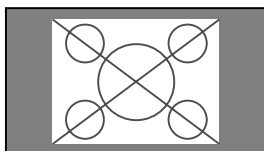

The image is true resolution.

FULL size screen

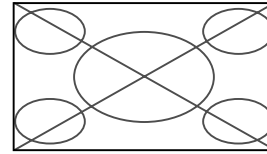

The image is expanded in the horizontal and vertical direction.

ZOOM size screen

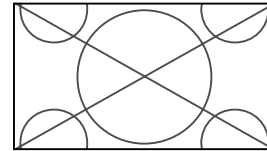

When wide signals are input.

TRUE

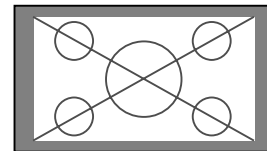

The image is true resolution.

FULL

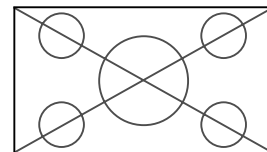

Information

■ Supported resolution

See page 7 of Model Information for details on the display output of the various VESA signal standards supported by the monitor.

■ "PICTURE SIZE" setting

When the setting of "PICTURE SIZE" is OFF, the size of RGB-input pictures will be TRUE in place of NORMAL.

■ When 852 (848) dot × 480 line wide VGA* signals with a vertical frequency of 60 Hz and horizontal frequency of 31.7 (31.0) kHz are input

Select an appropriate setting for RGB SELECT mode referring to the "Table of Signals Supported" on page 7 of Model Information.

* "VGA", "SVGA" and "SXGA" are registered trademarks of IBM, Inc. of the United States.

Note:

Do not allow the displayed in 4:3 mode for an extended period. This can cause a phosphor burn-in.

OSM(On Screen Menu) Controls

Menu Operations

The OSM window is displayed with respect to the screen as shown on the diagram.

- * Depending on the screen's mode, the OSM may be displayed differently.
In the explanation, the OSM section is shown close up.

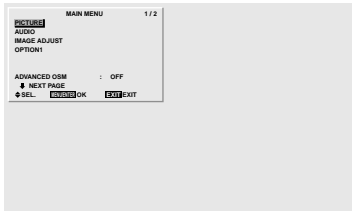

The following describes how to use the menus and the selected items.

1. Press the MENU/ENTER button on the remote control to display the MAIN MENU.

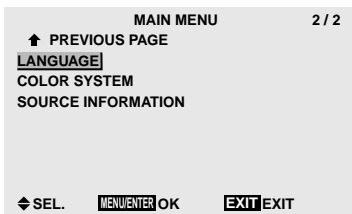
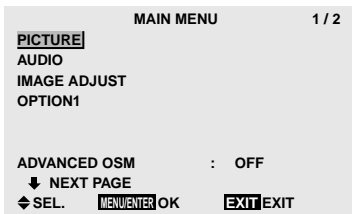

2. Press the cursor buttons ▲ ▼ on the remote control to highlight the menu you wish to enter.
3. Press the MENU/ENTER button on the remote control to select a sub menu or item.

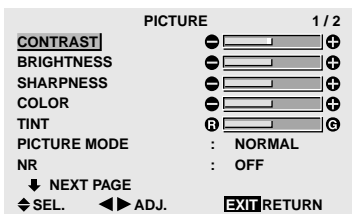

4. Adjust the level or change the setting of the selected item by using the cursor buttons ◀ ▶ on the remote control.

5. The adjustments or the settings that are stored in memory.
The change is stored until you change it again.
6. Repeat steps 2 – 5 to adjust an additional item, or press the EXIT button on the remote control to return to the main menu.

Note: The main menu disappears by pressing the EXIT button.

Information

Advanced menu mode

When “ADVANCED OSM” is set to “ON” in the main menu (1/2), full menu items will be shown.

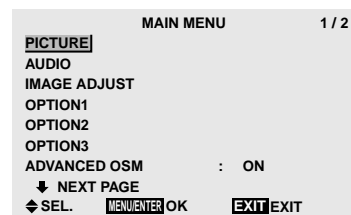

Menu Tree

■: Shaded areas indicate the default value.

- ← → + : Press the ◀ or ▶ button to adjust. The default value is at the center.

▭: Menu items in a ruled box are available when the ADVANCED OSM is set to ON.

Main menu	Sub menu	Sub menu 2	Sub menu 3	Sub menu 4	RESET	REFERENCE
PICTURE	CONTRAST	- ← → +			YES	18
	BRIGHTNESS	- ← → +			YES	18
	SHARPNESS	- ← → +			YES	18
	COLOR	- ← → +			YES	18
	TINT	- ← → +			YES	18
	PICTURE MODE	BRIGHT/NORMAL/THEAT.1/THEAT.2/DEFAULT			YES	18
	NR	OFF/NR-1/NR-2/NR-3			YES	19
	COLOR TEMP	LOW/MID LOW/MID/HIGH			YES	19
	WHITE BALANCE	GAIN RED	- ← → +		YES	19
		GAIN GREEN	- ← → +		YES	19
		GAIN BLUE	- ← → +		YES	19
		BIAS RED	- ← → +		YES	19
		BIAS GREEN	- ← → +		YES	19
		BIAS BLUE	- ← → +		YES	19
		RESET	OFF ← → ON		YES	19
		GAMMA	1 ← → 2 ← → 3 ← → 4		YES	20
		LOW TONE	AUTO ← → 1 ← → 2 ← → 3		YES	20
		COLOR TUNE	RED	Y ← → M	YES	21
			GREEN	C ← → Y	YES	21
			BLUE	M ← → C	YES	21
			YELLOW	G ← → R	YES	21
			MAGENTA	R ← → B	YES	21
			CYAN	B ← → G	YES	21
			RESET	OFF ← → ON	YES	21

Main menu	Sub menu	Sub menu 2	Sub menu 3	Sub menu 4	RESET	REFERENCE
AUDIO	BASS	- ← → +			YES	21
	TREBLE	- ← → +			YES	21
	BALANCE	L ← → R			YES	21
	AUDIO INPUT1	VIDEO 1-3 / HD/DVD 1-2 / RGB 1-3			YES	22
	AUDIO INPUT2	VIDEO 1-3 / HD/DVD 1-2 / RGB 1-3			YES	22
	AUDIO INPUT3	VIDEO 1-3 / HD/DVD 1-2 / RGB 1-3			YES	22

Main menu	Sub menu	Sub menu 2	Sub menu 3	Sub menu 4	RESET	REFERENCE
IMAGE ADJUST	ASPECT MODE	NORMAL/FULL/STADIUM/ZOOM/2.35:1/14:9			—	22
	V-POSITION	- ← → +			YES	22
	H-POSITION	- ← → +			YES	22
	V-HEIGHT	- ← → +			YES	22
	H-WIDTH	- ← → +			YES	22
	AUTO PICTURE	OFF ← → ON*2			NO	22
	FINE PICTURE*1	- ← → +*2			YES	22
PICTURE ADJ.*1	- ← → +*2			YES	22	

Main menu	Sub menu	Sub menu 2	Sub menu 3	Sub menu 4	RESET	REFERENCE
OPTION1	OSM	DISPLAY OSM	OFF ← → ON		YES	23
		OSM ADJ.	1 ← → 2 ← → 3 ← → 4 ← → 5 ← → 6		YES	23
		OSM ANGLE	H ← → V		YES	23
		OSM ORBITER	OFF ← → ON		YES	23
		BNC INPUT	RGB ← → COMP.		YES	24
	D-SUB INPUT	RGB		—	24	
	RGB SELECT	AUTO/STILL/MOTION/WIDE1/WIDE2/DTV		YES	24	
	HD SELECT	1080B/1035I/1080A		NO	25	
	INPUT SKIP	OFF ← → ON		YES	25	
	ALL RESET	OFF ← → ON		—	26	

Main menu	Sub menu	Sub menu 2	Sub menu 3	Sub menu 4	RESET	REFERENCE	
OPTION2	PWR. MGT.	OFF↔ON			YES	26	
	CINEMA MODE	OFF↔ON			YES	27	
	LONG LIFE	PLE		AUTO/LOCK 1/LOCK 2/LOCK 3		YES	27
		ORBITER		AUTO 1		YES	28
				AUTO 2		YES	28
				MANUAL	H-DOT/V-LINE/TIME	YES	28
				OFF		YES	28
		INVERSE	OFF			YES	28
			ON		WORKING TIME/WAITING TIME	YES	28
			WHITE			YES	28
		SCREEN WIPER	OFF			YES	29
			ON		WORKING TIME/WAITING TIME/SPEED	YES	29
		SOFT FOCUS	OFF/1/2/3/4			YES	30
	GRAY LEVEL		0↔3↔15			YES	30
	S1/S2		AUTO↔OFF			YES	30
	PICTURE SIZE		OFF↔ON			YES	31
DVI SET UP	PLUG/PLAY		PC↔STB/DVD*3		NO	31	
	BLACK LEVEL		LOW↔HIGH*4		NO	31	

Main menu	Sub menu	Sub menu 2	Sub menu 3	Sub menu 4	RESET	REFERENCE		
OPTION3	TIMER	PRESENT TIME	DAYLIGHT SAVING TIME	OFF↔ON	NO	31		
			DAY/HOUR/MINUTES		NO	31		
		PROGRAM	OFF		YES	32		
			ON	DATE/ON/OFF(HOUR, MINUTE)/INPUT/FUNCTION	YES	32		
	PWR. ON MODE		LAST / VIDEO 1-3 / HD/DVD 1-2 / RGB 1-3		YES	33		
	CONTROL LOCK		OFF↔ON		YES	34		
	IR REMOTE		OFF↔ON		YES	34		
	LOOP OUT		OFF↔ON		YES	35		
	ID NUMBER		ALL↔1↔256		YES	35		
	VIDEO WALL	DIVIDER		OFF/1/4/9		YES	36	
		POSITION		No.1↔No.4/No.7↔No.15		—	36	
		DISP. MODE		SPLIT↔BLANK		YES	37	
		AUTO ID		OFF↔ON		YES	37	
		IMAGE ADJUST	ASPECT MODE		NORMAL/FULL/STADIUM/ZOOM/2.35:1/14:9		—	37
			V-POSITION		—↔+		YES	37
			H-POSITION		—↔+		YES	37
			V-HEIGHT		—↔+		YES	37
			H-WIDTH		—↔+		YES	37
			AUTO PICTURE		OFF↔ON*2		NO	37
				FINE PICTURE*1	—↔+*2		YES	37
				PICTURE ADJ.*1	—↔+*2		YES	37
		P. ON DELAY		OFF↔ON		YES	38	
		PLE LINK		OFF↔ON		YES	38	
		REPEAT TIMER		OFF			YES	39
				ON	DIVIDER/SOURCE/WORK TIME	YES	39	

Main menu	Sub menu	Sub menu 2	Sub menu 3	Sub menu 4	RESET	REFERENCE
ADVANCED OSM		OFF↔ON			YES	39
LANGUAGE		ENGLISH/DEUTSCH/FRANÇAIS/ESPAÑOL/ITALIANO/SVENSKA/中文			NO	40
COLOR SYSTEM		AUTO/3.58NTSC/4.43 NTSC/PAL/PAL 60/PAL-N/PAL-M/SECAM			NO	40
SOURCE INFORMATION		—			—	40

*1 Only when AUTO PICTURE is OFF

*2 RGB/PC only

*3 The default value is PC for model PD4220V.

*4 The default value is LOW for model PD4220V.

Picture Settings Menu

Adjusting the picture

The contrast, brightness, sharpness, color and tint can be adjusted as desired.

Example: Adjusting the contrast

1. On the MAIN MENU, select "PICTURE", then press the MENU/ENTER button.
The "PICTURE" screen appears.
2. Use the ▲ and ▼ buttons to select "CONTRAST".

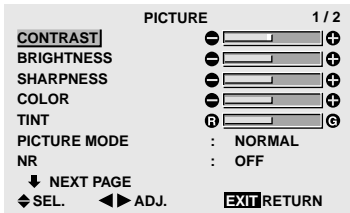

3. Use the ◀ and ▶ buttons to adjust the contrast.



* If neither the ◀ or ▶ button is pressed within 5 seconds, the current setting is set and the previous screen reappears.

Note: If "CAN NOT ADJUST" appears ...
When trying to enter the PICTURE submenu, make sure PICTURE MODE is not set to DEFAULT.

Information

Picture adjustment screen

CONTRAST Changes the picture's white level.
 BRIGHTNESS .. Changes the picture's black level.
 SHARPNESS .. Changes the picture's sharpness.
 Adjusts picture detail of VIDEO display.
 COLOR Changes the color density.
 TINT Changes the picture's tint. Adjust for natural colored skin, background, etc.

Adjusting the computer image

Only the contrast and brightness can be adjusted when a computer signal is connected.

Restoring the factory default settings

Select "DEFAULT" under the "PICTURE MODE" settings.

Setting the picture mode according to the brightness of the room

There are four picture modes that can be used effectively according to the environment in which you are viewing the display.

Example: Setting the "THEAT. 1" mode

1. On the MAIN MENU, select "PICTURE", then press the MENU/ENTER button.
The "PICTURE" screen appears.
2. Use the ▲ and ▼ buttons to select "PICTURE MODE".

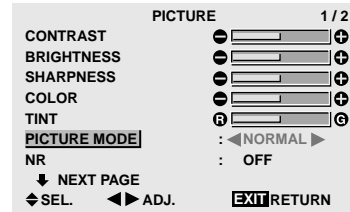

3. To set to "THEAT. 1" ...

Use the ◀ and ▶ buttons to select "THEAT. 1".
The mode switches as follows each time the ◀ or ▶ button is pressed:

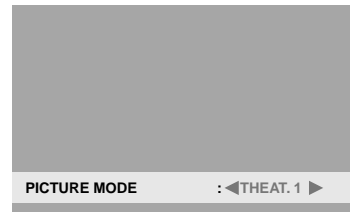
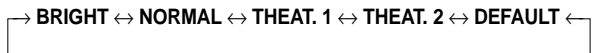

* If neither the ◀ or ▶ button is pressed within 5 seconds, the current selection is set and the previous screen reappears.

Information

Types of picture modes

THEAT. 1, 2 Set this mode when watching video in a dark room.
 This mode provides darker, finer pictures, like the screen in movie theaters.
 For a darker image, select THEAT. 2.
 NORMAL Set this mode when watching video in a bright room.
 This mode provides dynamic pictures with distinct differences between light and dark sections.
 BRIGHT This mode provides brighter pictures than NORMAL.
 DEFAULT Use this to reset the picture to the factory default settings.

Reducing noise in the picture

Use these settings if the picture has noise due to poor reception or when playing video tapes on which the picture quality is poor.

Example: Setting "NR-3"

1. On the MAIN MENU, select "PICTURE", then press the MENU/ENTER button.
The "PICTURE" screen appears.
2. Use the ▲ and ▼ buttons to select "NR".

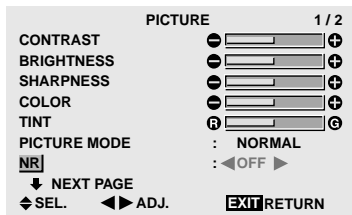

3. Use the ◀ and ▶ buttons to select "NR-3".
The mode switches as follows each time the ◀ or ▶ button is pressed:

→ OFF ↔ NR-1 ↔ NR-2 ↔ NR-3 ←



* If neither the ◀ or ▶ button is pressed within 5 seconds, the current selection is set and the previous screen reappears.

Information

■ NR

- * "NR" stands for Noise Reduction.
- * This function reduces noise in the picture.

■ Types of noise reduction

There are three types of noise reduction. Each has a different level of noise reduction.

The effect becomes stronger as the number increases (in the order NR-1 → NR-2 → NR-3).

OFF Turns the noise reduction function off.

Setting the color temperature

Use this procedure to set color tone produced by the plasma display.

Example: Setting "HIGH"

1. On the MAIN MENU, select "PICTURE", then press the MENU/ENTER button.
The "PICTURE" screen appears.
2. Use the ▲ and ▼ buttons to select "COLOR TEMP.".
3. Use the ◀ and ▶ buttons to select "HIGH".
The mode switches as follows each time the ◀ or ▶ button is pressed:

→ LOW ↔ MID LOW ↔ MID ↔ HIGH ←

* See below to set "WHITE BALANCE".

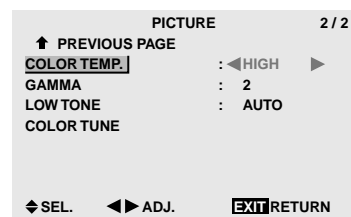

* If neither the ◀ or ▶ button is pressed within 5 seconds, the current selection is set and the previous screen reappears.

Information

■ Setting the color temperature

LOW Redder
MID LOW Slightly redder
MID Standard (slightly bluer)
HIGH Bluer

■ Restoring the factory default settings

Select "ALL RESET" under the OPTION1 menu. Note that this also restores other settings to the factory defaults.

Adjusting the color to the desired level

Use this procedure to adjust the white balance for each color temperature to achieve the desired color quality.

Example: Adjusting the "GAIN RED" of "HIGH" color temperature

Set "ADVANCED OSM" to "ON" in the main menu (1/2), then perform the following operations.

Perform Steps 1-3 of COLOR TEMP., then...

4. Press the MENU/ENTER button.
The "WHITE BALANCE" screen appears.
5. Use the ▲ and ▼ buttons to select "GAIN RED".

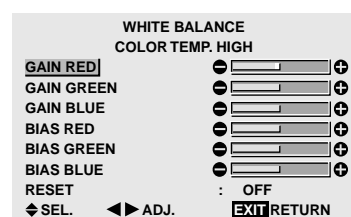

6. Adjust the white balance using the ◀ and ▶ buttons.



* If neither the ◀ or ▶ button is pressed within 5 seconds, the current setting is set and the previous screen reappears.

Information

■ **Adjusting the white balance**

GAIN R/G/B White balance adjustment for signal level

BIAS R/G/B White balance adjustment for black level

RESET Resets settings to the factory default values. Use ◀ and ▶ buttons to select “ON”, then press the MENU/ENTER button.

■ **Restoring the factory default settings**

Select “RESET” under the WHITE BALANCE menu.

Changing the Gamma Curve

This feature adjusts the brightness of the midtone areas while keeping shadows and highlights unchanged.

Example: Setting “3”

Set “ADVANCED OSM” to “ON” in the MAIN MENU (1/2), then perform the following operations.

1. On the MAIN MENU, select “PICTURE”, then press the MENU/ENTER button.
The “PICTURE” screen appears.
2. Use the ▲ and ▼ buttons to select “GAMMA”.
3. Use the ◀ and ▶ buttons to select “3”.
The mode switches as follows each time the ◀ or ▶ button is pressed:

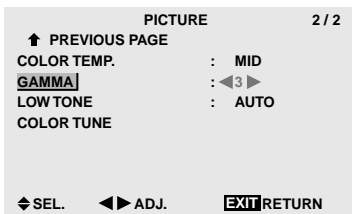
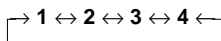

Information

■ **GAMMA settings**

The picture becomes darker as the number increases (in the sequence of 1, 2, 3, 4).

■ **Restoring the factory default settings**

Select “ALL RESET” under the OPTION1 menu. Note that this also restores other settings to the factory defaults.

Making the Low Tone adjustments

This feature allows more detailed tone to be reproduced especially in the dark area.

Example: Setting “2”

Set “ADVANCED OSM” to “ON” in the MAIN MENU (1/2), then perform the following operations.

1. On the MAIN MENU, select “PICTURE”, then press the MENU/ENTER button.
The “PICTURE” screen appears.
2. Use the ▲ and ▼ buttons to select “LOW TONE”.
3. Use the ◀ and ▶ buttons to select “2”.
The mode switches as follows each time the ◀ or ▶ button is pressed:

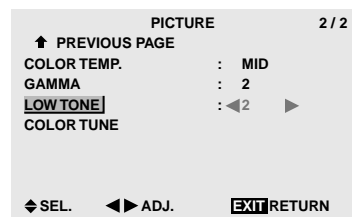
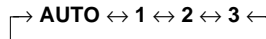

Information

■ **LOW TONE settings**

AUTO Will automatically appraise the picture and make adjustments.

1 Will apply the dither method suitable for still pictures.

2 Will apply the dither method suitable for motion pictures.

3 Will apply the error diffusion method.

■ **Restoring the factory default settings**

Select “ALL RESET” under the OPTION1 menu. Note that this also restores other settings to the factory defaults.

Adjusting the colors

Use this procedure to adjust hue and color density for red, green, blue, yellow, magenta and cyan. You can accentuate the green color of trees, the blue of the sky, etc.

Example: Adjusting the color tune for blue

Set "ADVANCED OSM" to "ON" in the MAIN MENU (1/2), then perform the following operations.

1. On the MAIN MENU, select "PICTURE", then press the MENU/ENTER button.
The "PICTURE" screen appears.
2. Use the ▲ and ▼ buttons to select "COLOR TUNE", then press the MENU/ENTER button.
The "COLOR TUNE" screen appears.
3. Use the ▲ and ▼ buttons to select "BLUE".
4. Adjust using the ◀ and ▶ buttons.

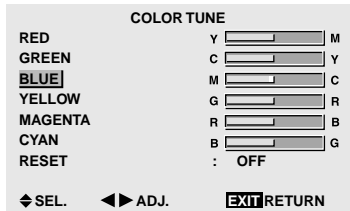

* If neither the ◀ or ▶ button is pressed within 5 seconds, the current selection is set and the previous screen reappears.

To continue making other adjustments...
Repeat from step 3.

Information

■ COLOR TUNE settings

RED Makes red's adjustment
 GREEN Makes green's adjustment
 BLUE Makes blue's adjustment
 YELLOW Makes yellow's adjustment
 MAGENTA Makes magenta's adjustment
 CYAN Makes cyan's adjustment
 RESET Resets settings to the factory default value. Use ◀ and ▶ buttons to select "ON", then press the MENU/ENTER button.

■ Restoring the factory default settings

Select "ALL RESET" under the OPTION1 menu. Note that this also restores other settings to the factory defaults.

Audio Settings Menu

Adjusting the treble, bass and left/right balance and audio input select

The treble, bass and left/right balance can be adjusted to suit your tastes.

Example: Adjusting the bass

1. On the MAIN MENU, select "AUDIO", then press the MENU/ENTER button.
The "AUDIO" screen appears.
2. To adjust the bass ...
Use the ▲ and ▼ buttons to select "BASS".
3. Adjust the bass using the ◀ and ▶ buttons.

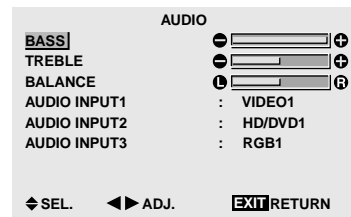

To continue adjusting the audio ...
Repeat from step 2.

Note : If "CAN NOT ADJUST" appears...
Set "AUDIO INPUT" on the AUDIO menu correctly.

Information

■ Audio settings menu

BASS Controls the level of low frequency sound.
 TREBLE Controls the level of high frequency sound.
 BALANCE Controls the balance of the left and right channels.

■ Restoring the factory default settings

Select "ALL RESET" under the OPTION1 menu. Note that this also restores other settings to the factory defaults.

Setting the allocation of the audio connectors

Setting the AUDIO 1, 2, and 3 connectors to the desired input.

Example: Setting "AUDIO INPUT1" to "VIDEO 2"

1. On the MAIN MENU, select "AUDIO", then press the MENU/ENTER button.
The "AUDIO" screen appears.
2. Use the ▲ and ▼ buttons to select "AUDIO INPUT1".
3. To set the AUDIO INPUT1 to "VIDEO2"...
Use the ◀ and ▶ buttons to select "VIDEO2".
The mode switches as follows each time the ◀ or ▶ button is pressed:
The available sources depend on the setting of "BNC INPUT".

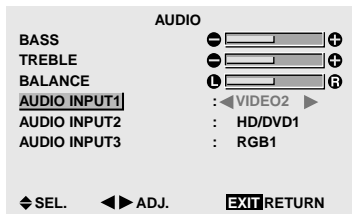

Information

■ AUDIO INPUT

A single audio input cannot be selected as the audio channel for more than one input terminal.

■ Restoring the factory default settings

Select "ALL RESET" under the OPTION1 menu. Note that this also restores other settings to the factory defaults.

Image Adjust Settings Menu

Adjusting the Position, Size, Fine Picture, Picture Adj

The position of the image can be adjusted and flickering of the image can be corrected.

Example: Adjusting the vertical position in the normal mode

1. On the MAIN MENU, select "IMAGE ADJUST", then press the MENU/ENTER button.
The "IMAGE ADJUST" menu appears.

Default settings (when RGB/PC is selected)

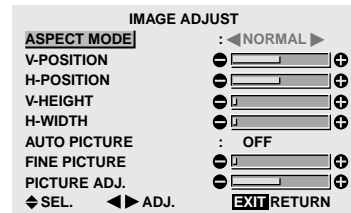

- * The settings on the IMAGE ADJUST menu are not preset at the factory.

To select a mode ...

Use the ◀ and ▶ buttons to select a mode.

The mode switches as follows each time the ◀ or ▶ button is pressed:

NORMAL ↔ **FULL**

- * The mode can also be switched by pressing the "WIDE" button on the remote control.

2. To adjust the vertical position ...

Use the ▲ and ▼ buttons to select "V-POSITION".

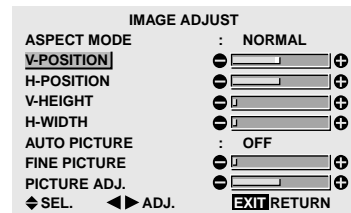

3. Adjust using the ◀ and ▶ buttons.



- * If neither the ◀ or ▶ button is pressed within 5 seconds, the current setting is set and the previous screen reappears.

To continue making other computer image adjustments ...

Repeat from step 2.

Information

■ When “AUTO PICTURE” is “OFF”

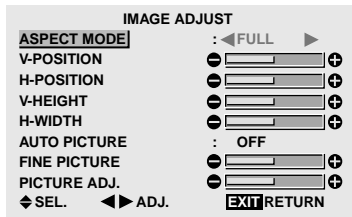

When Auto Picture is off, the Fine Picture and the Picture ADJ. items are displayed so that you can adjust them.

■ Adjusting the Auto Picture

ON The Picture ADJ., Fine Picture and Position adjustments are made automatically.

Not available for digital ZOOM.

OFF The Picture ADJ., Fine Picture and Position adjustments are made manually.

* If FINE PICTURE won't be adjusted, set Auto Picture to OFF and adjust manually.

■ Adjusting the position of the image

V-POSITION ... Adjusts the vertical position of the image.

H-POSITION ... Adjusts the horizontal position of the image.

V-HEIGHT Adjusts the vertical size of the image. (Except for STADIUM mode)

H-WIDTH Adjusts the horizontal size of the image. (Except for STADIUM mode)

FINE PICTURE* .. Adjusts for flickering.

PICTURE ADJ.* .. Adjusts for striped patterns on the image.

* The Picture ADJ. and Fine Picture features are available only when the “Auto Picture” is off.

* The AUTO PICTURE, FINE PICTURE and PICTURE ADJ. are available only for RGB signals. But, these features are not available for moving pictures on VIDEO, HD/DVD or RGB.

■ Restoring the factory default settings

Select “ALL RESET” under the OPTION1 menu. Note that this also restores other settings to the factory defaults except for Auto Picture.

Option 1 Settings Menu

Setting the on-screen menu

This sets the position of the menu, the display format (horizontal or vertical) etc.

Example: Turning the DISPLAY OSM off

1. On the MAIN MENU, select “OPTION1”, then press the MENU/ENTER button. The “OPTION1” menu appears.
2. Use the ▲ and ▼ buttons to select “OSM”, then press the MENU/ENTER button. The “OSM” menu appears.
3. Use the ▲ and ▼ buttons to select “DISPLAY OSM”.
4. To set the DISPLAY OSM to “OFF”... Use the ◀ and ▶ buttons to select “OFF”.

The mode switches as follows each time the ◀ or ▶ button is pressed:

ON ↔ OFF

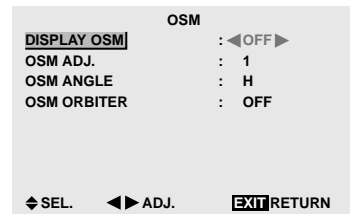

Information

■ DISPLAY OSM settings

ON The on-screen menu appears.

OFF The on-screen menu does not appear.

If you press the DISPLAY button on the remote control for more than 3 seconds the main menu will appear and can be set (although it is not ON).

■ OSM ADJUST settings

Adjusts the position of the menu when it appears on the screen.

The position can be set between 1 to 6.



■ OSM ANGLE settings

Sets the display format (landscape “H” or portrait “V”). When the unit is installed vertically set the OSM ANGLE at “V”.

“H”

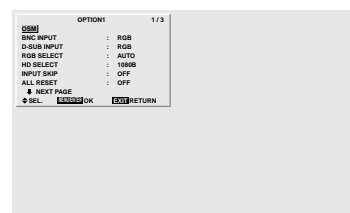

“V”

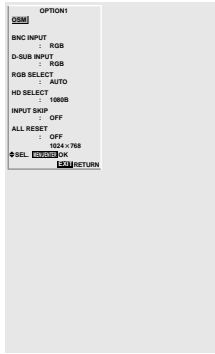

OSM ORBITER settings

ON The position of the menu will be shifted by eight dots each time OSM is displayed.
 OFF OSM will be displayed at the same position.

Restoring the factory default settings

Select “ALL RESET” under the OPTION1 menu. Note that this also restores other settings to the factory defaults except for Auto Picture.

Setting the BNC connectors

Select whether to set the input of the 5 BNC connectors to RGB and component.

Example: Set the BNC INPUT mode to “COMP.”

1. On the MAIN MENU, select “OPTION1”, then press the MENU/ENTER button.
The “OPTION1” screen appears.
2. Use the ▲ and ▼ buttons to select “BNC INPUT”.
3. To set the BNC INPUT mode to “COMP.”...
Use the ◀ and ▶ buttons to select “COMP.”.
The mode switches as follows each time the ◀ or ▶ button is pressed:

RGB ↔ COMP.

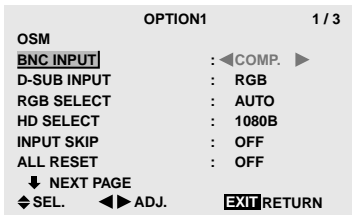

Information

BNC INPUT Settings

RGB Use the 5BNC terminals for RGB input.
 COMP. Use the 3BNC terminals for component input.

Restoring the factory default settings

Select “ALL RESET” under the OPTION1 menu. Note that this also restores other settings to the factory defaults.

Checking the signal being transmitted to RGB1 terminal

Use this to confirm the signal being transmitted to the RGB1 terminal.

It is set to RGB and can not be adjusted.

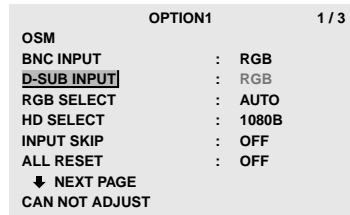

Setting a computer image to the correct RGB select screen

With the computer image, select the RGB Select mode for a moving image such as (video) mode, wide mode or digital broadcast.

Example: Setting the “RGB SELECT” mode to “MOTION”

1. On the MAIN MENU, select “OPTION1”, then press the MENU/ENTER button.
The “OPTION1” screen appears.
2. Use the ▲ and ▼ buttons to select “RGB SELECT”.
3. To set the RGB select mode to “MOTION” ...
Use the ◀ and ▶ buttons to select “MOTION”.
The mode switches as follows each time the ◀ or ▶ button is pressed:

→ AUTO ↔ STILL ↔ MOTION ↔ WIDE1 ↔ WIDE2 ↔ DTV ←

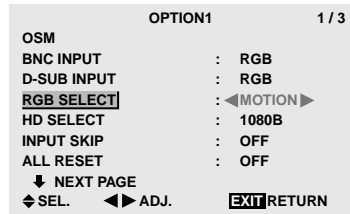

Information

■ RGB SELECT modes

One of these 6 modes must be selected in order to display the following signals correctly.

AUTO Select the suitable mode for the specifications of input signals as listed in the table “Computer input signals supported by this system” on page 7 of Model Information.

STILL To display VESA standard signals. (Use this mode for a still image from a computer.)

MOTION The video signal (from a scan converter) will be converted to RGB signals to make the picture more easily viewable. (Use this mode for a motion image from a computer.)

WIDE1 When an 852 dot × 480 line signal with a horizontal frequency of 31.7kHz is input, the image may be compressed horizontally. To prevent this, set RGB SELECT to WIDE1.

WIDE2 When an 848 dot × 480 line signal with a horizontal frequency of 31.0 kHz is input, the image may be compressed horizontally. To prevent this, set RGB SELECT to WIDE2.

DTV Set this mode when watching digital broadcasting (480P).

See page 7 of Model Information for the details of the above settings.

■ Restoring the factory default settings

Select “ALL RESET” under the OPTION1 menu. Note that this also restores other settings to the factory defaults.

Setting high definition images to the suitable screen size

Use this procedure to set whether the number of vertical lines of the input high definition image is 1035 or 1080.

Example: Setting the “1080B” mode to “1035I”

1. On the MAIN MENU, select “OPTION1”, then press the MENU/ENTER button.
The “OPTION1” screen appears.
2. Use the ▲ and ▼ buttons to select “HD SELECT”.
3. To set the HD SELECT mode to “1035I” ...
Use the ◀ and ▶ buttons to select “1035I”.
The mode switches as follows each time the ◀ or ▶ button is pressed:

→1080B ↔ 1035I ↔ 1080A ←

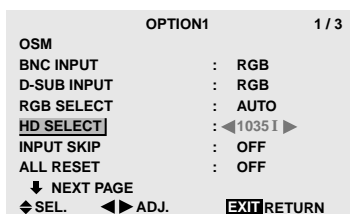

Information

■ HD SELECT modes

These 3 modes are not displayed in correct image automatically.

1080B Standard digital broadcasts

1035I Japanese “High Vision” signal format

1080A Special Digital broadcasts (for example : DTC100)

Setting the Input Skip

When this is ON, signals which are not present will be skipped over and only pictures whose signals are being transmitted will be displayed.

This setting is valid only for the INPUT SELECT button on the unit.

Example: Set to “ON”

1. On the MAIN MENU, select “OPTION1”, then press the MENU/ENTER button.
The “OPTION1” screen appears.
2. Use the ▲ and ▼ buttons to select “INPUT SKIP”.
3. To set the INPUT SKIP mode to “ON”...
Use the ◀ and ▶ buttons to select “ON”.
The mode switches as follows each time the ◀ or ▶ button is pressed:

OFF ↔ ON

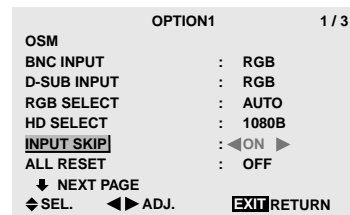

Information

■ INPUT SKIP settings

OFF Regardless of the presence of the signal, scan and display all signals.

ON If no input signal is present, skip that signal.

* “SETTING NOW” will appear during the input search.

■ Restoring the factory default settings

Select “ALL RESET” under the OPTION1 menu. Note that this also restores other settings to the factory defaults.

Resetting to the default values

Use these operations to restore all the settings (PICTURE, AUDIO, IMAGE ADJUST, OPTION1~3, etc) to the factory default values.

Refer to page 16 for items to be reset.

1. On the MAIN MENU, select “OPTION1”, then press the MENU/ENTER button.
The “OPTION1” screen appears.
2. Use the ▲ and ▼ buttons to select “ALL RESET”.

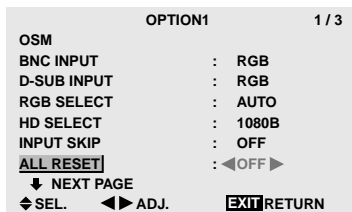

3. Use the ◀ and ▶ buttons to select “ON”, then press the MENU/ENTER button.

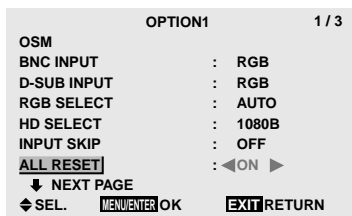

When the “SETTING NOW” screen disappears, then all the settings are restored to the default values.

Option2 Settings Menu

Setting the power management for computer images

This energy-saving (power management) function automatically reduces the monitor’s power consumption if no operation is performed for a certain amount of time.

Example: Turning the power management function on
Set “ADVANCED OSM” to “ON” in the main menu (1/2), then perform the following operations.

1. On the MAIN MENU, select “OPTION2”, then press the MENU/ENTER button.
The “OPTION2” screen appears.
2. Use the ▲ and ▼ buttons to select “PWR. MGT.”.
3. To turn the power management function on ...
Use the ◀ and ▶ buttons to select “ON”.
The mode switches as follows each time the ◀ or ▶ button is pressed:

ON ↔ OFF

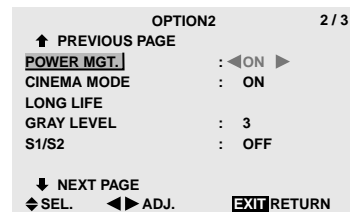

Information

■ Power management function

- * The power management function automatically reduces the monitor’s power consumption if the computer’s keyboard or mouse is not operated for a certain amount of time. This function can be used when using the monitor with a computer.
- * If the computer’s power is not turned on or if the computer and selector tuner are not properly connected, the system is set to the off state.
- * For instructions on using the computer’s power management function, refer to the computer’s operating instructions.

■ Power management settings

- ON In this mode the power management function is turned on.
- OFF In this mode the power management function is turned off.

■ Power management function and POWER/STANDBY indicator

The POWER/STANDBY indicator indicates the status of the power management function. See page 27 for indicator status and description.

■ Restoring the factory default settings

Select “ALL RESET” under the OPTION1 menu. Note that this also restores other settings to the factory defaults.

POWER/STANDBY indicator

Power management mode	POWER/STANDBY indicator	Power management operating status	Description	Turning the picture back on
On	Green	Not activated.	Horizontal and vertical synchronizing signals are present from the computer.	Picture already on.
Off	Red	Activated.	Horizontal and/or vertical synchronizing signals are not sent from the computer.	Operate the keyboard or mouse. The picture reappears.

Setting the picture to suit the movie

The film image is automatically discriminated and projected in an image mode suited to the picture.

[NTSC, PAL, PAL60, 480I (60Hz), 525I (60Hz), 576I (50Hz), 625I (50Hz), 1035I (60Hz), 1080I (60Hz) only]

Example: Setting the "CINEMA MODE" to "OFF"

Set "ADVANCED OSM" to "ON" in the main menu (1/2), then perform the following operations.

1. On the MAIN MENU, select "OPTION2", then press the MENU/ENTER button.
The "OPTION2" screen appears.
2. Use the ▲ and ▼ buttons to select "CINEMA MODE".
3. To set the CINEMA MODE to "OFF" ...
Use the ◀ and ▶ buttons to select "OFF".
The mode switches as follows each time the ◀ or ▶ button is pressed:

ON ↔ OFF

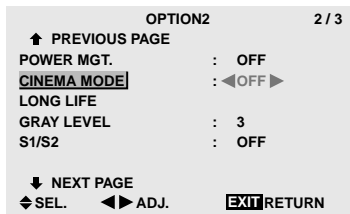

Information

■ CINEMA MODE

ON Automatic discrimination of the image and projection in cinema mode.

OFF Cinema mode does not function.

■ Restoring the factory default settings

Select "ALL RESET" under the OPTION1 menu. Note that this also restores other settings to the factory defaults.

Reducing burn-in of the screen

The brightness of the screen, the position of the picture, positive/negative mode and screen wiper are adjusted to reduce burn-in of the screen.

Set "ADVANCED OSM" to "ON" in the main menu (1/2), then perform the following operations.

1. On the MAIN MENU, select "OPTION2", then press the MENU/ENTER button.
The "OPTION2" screen appears.
2. Use the ▲ and ▼ buttons to select "LONG LIFE", then press the MENU/ENTER button.
The "LONG LIFE" screen appears.

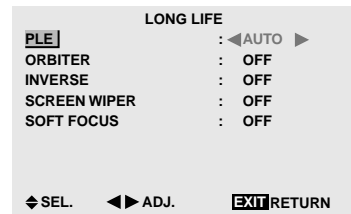

3. Set the LONG LIFE mode using ▲▼◀▶ and ▶ buttons.
See page 27 to set PLE.
See page 28 to set ORBITER.
See page 28 to set INVERSE.
See page 29 to set SCREEN WIPER.
See page 30 to set SOFT FOCUS.

Information

■ Restoring the factory default settings

Select "ALL RESET" under the OPTION1 menu. Note that this also restores other settings to the factory defaults.

PLE (Peak Luminance Enhancement)

Use this to activate the brightness limiter.

Example: Setting "PLE" to "LOCK1"

Perform Steps 1-2 of LONG LIFE, then...

3. Use the ▲ and ▼ buttons to select "PLE".
4. Use the ◀ and ▶ buttons to select "LOCK1".
The mode switches as follows each time the ◀ or ▶ button is pressed:

→AUTO ↔ LOCK1 ↔ LOCK2 ↔ LOCK3←



Information

■ PLE settings

AUTO The brightness of the screen is adjusted automatically to suit the picture quality.

LOCK1, 2, 3 Sets maximum brightness.
The brightness level decreases in the order of LOCK 1, 2, 3. LOCK 3 provides minimum brightness.

ORBITER

Use this to set the picture shift.

Example: Setting "ORBITER" to "AUTO1"

Perform Steps 1-2 of LONG LIFE, then...

3. Use the ▲ and ▼ buttons to select "ORBITER".

4. Use the ◀ and ▶ buttons to select "AUTO1".

The mode switches as follows each time the ◀ or ▶ button is pressed:

→OFF ↔ AUTO1 ↔ AUTO2 ↔ MANUAL←

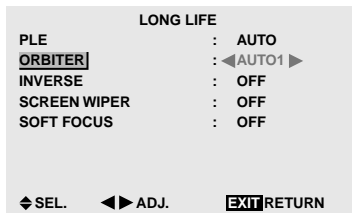

Information

■ ORBITER settings

OFF Orbiter mode does not function.
This is the default setting when RGB is input.

AUTO1 The picture moves around the screen intermittently, making the picture smaller. This is the default setting when a Video or a DVD/HD/DTV signal is input. Set to "OFF" when these signals are not used.

AUTO2 The picture moves around the screen intermittently, making the picture bigger.

MANUAL User can adjust the orbiter function (Horizontal Dot, Vertical Line and Time) manually.

See the following explanation.

* When a Video or a DVD/HD/DTV signal is input, the AUTO1 and 2 functions will affect only the moving picture and will not make the screen smaller or bigger.

Adjust the ORBITER function manually

Set the amount of shift and the time between movement.

Example: Setting so that the picture moves 2 dots horizontally and 3 lines vertically every 3 minutes.

Perform Steps 1-3 of ORBITER, then...

4. Use the ◀ and ▶ buttons to select "MANUAL", then press the MENU/ENTER button.

THE "ORBITER" screen appears.

5. Adjust the items using the ▲▼◀▶ buttons.

The mode switches as follows each time the ◀ or ▶ button is pressed:

• H-DOT

→1 DOT ↔ 2 DOT ↔ ↔ 19 DOT ↔ 20 DOT←

• V-LINE

→1 LINE ↔ 2 LINE ↔ ↔ 19 LINE ↔ 20 LINE←

• TIME

→1 M ↔ 2 M ↔ 3 M ↔ 4 M ↔ 5 M←

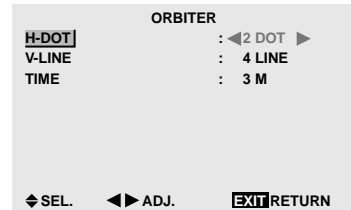

Information

■ ORBITER Function settings

H-DOT Moves from 1 to 20 dots in the horizontal direction.

V-LINE Moves from 1 to 20 lines in the vertical direction.

TIME Interval of 1~5 minutes (1 horizontal dot or 1 vertical line per interval).

INVERSE

Use this to set the inverse mode or to display a white screen.

Example: Setting "INVERSE" to "WHITE"

Perform Steps 1-2 of LONG LIFE, then...

3. Use the ▲ and ▼ buttons to select "INVERSE".

4. Use the ◀ and ▶ buttons to select "WHITE".

The mode switches as follows each time the ◀ or ▶ button is pressed:

→OFF ↔ ON ↔ WHITE←

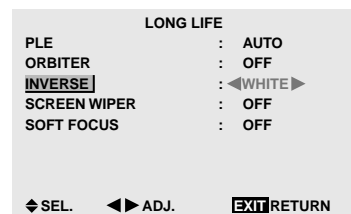

Information

■ INVERSE Settings

ON The picture is displayed alternately between positive image and negative image.
You can set the time by pressing the MENU/ENTER button while "ON" is set.

OFF Inverse mode does not function.

WHITE ... The entire screen turns white.

You can set the time by pressing the MENU/ENTER button while "ON" is set.

Setting the time for INVERSE/WHITE

Set a time duration.

Example: Setting to that the INVERSE mode starts in 2 hours and proceeds for one hour and a half.

Perform Steps 1-3 of INVERSE, then...

4. Use the ◀ and ▶ buttons to select "ON", then press the MENU/ENTER button.
THE "INVERSE/WHITE" screen appears.

5. Adjust the time using the ▲▼◀ and ▶ buttons.
The mode switches as follows each time the ◀ or ▶ button is pressed:

- WORKING TIME

→ON ↔ 00H03M ↔ 00H06M ↔ ↔ 12H42M ↔ 12H45M←

- WAITING TIME

→00H03M ↔ 00H06M ↔ 00H09M ↔ ... ↔ 12H42M ↔ 12H45M←

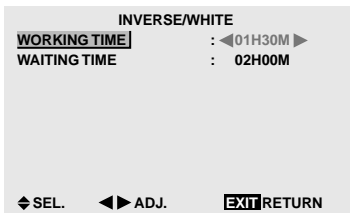

Information

■ Setting the time

WORKING TIME Set the time duration for "INVERSE/WHITE".

When the WORKING TIME is set to "ON" the mode will stay on.

WAITING TIME Set the standby time until the "INVERSE/WHITE" mode starts.

* The "WAITING TIME" can not be set when the "WORKING TIME" is ON.

* THE "WORKING TIME" and "WAITING TIME" can be set for up to 12 hours and 45 minutes in units of 3 minutes.

* Ending a WORKING TIME function, the monitor will be STAND BY.

[Example]

WORKING TIME: 01H30M

WAITING TIME: 02H00M

←----- 2 H -----*----- 1.5 H -----*-----
 Start INVERSE/WHITE Start STAND BY

■ To select "ON" for the "WORKING TIME"...

Set the hours of the working time to 0H and the minutes to 0M. "ON" will be displayed.

SCREEN WIPER

When this is set to ON, a white vertical bar moves repeatedly from the left and of the screen to the right end at a constant speed.

Example: Setting "SCREEN WIPER" to "ON"

Perform Steps 1-2 of LONG LIFE, then...

3. Use the ▲ and ▼ buttons to select "SCREEN WIPER".

4. Use the ◀ and ▶ buttons to select "ON".
The mode switches as follows each time the ◀ or ▶ button is pressed:

OFF ↔ ON

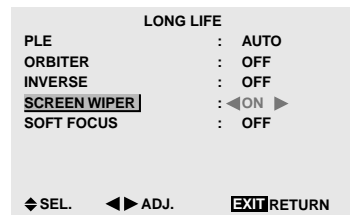

Information

■ SCREEN WIPER

ON The white vertical bar appears.

You can set the time by pressing the MENU/ENTER button while "ON" is set.

OFF Screen wiper mode does not function.

Setting the time for SCREEN WIPER

Set a time duration and the speed.

Example: Setting to that the SCREEN WIPER mode starts in 30 minutes and proceeds for one hour and a half.

Perform Steps 1-3 of SCREEN WIPER, then...

4. Use the ◀ and ▶ buttons to select "ON", then press the MENU/ENTER button.
THE "SCREEN WIPER" screen appears.

5. Adjust the time and speed using the ▲▼◀ and ▶ buttons.
The mode switches as follows each time the ◀ or ▶ button is pressed:

- WORKING TIME

→ON ↔ 00H03M ↔ 00H06M ↔ ↔ 12H42M ↔ 12H45M←

- WAITING TIME

→00H03M ↔ 00H06M ↔ 00H09M ↔ ... ↔ 12H42M ↔ 12H45M←

- SPEED

→1 ↔ 2 ↔ 3 ↔ 4 ↔ 5←

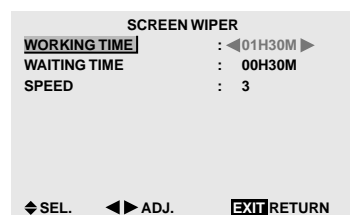

Information

■ Setting the time

WORKING TIME Set the time duration for “SCREEN WIPER”.

When the WORKING TIME is set to “ON” the mode will stay on.

WAITING TIME Set the standby time until the “SCREEN WIPER” mode starts.

SPEED Set the moving speed for the “SCREEN WIPER”. The speed decreases as the number increases.

* The “WAITING TIME” can not be set when the “WORKING TIME” is ON.

* THE “WORKING TIME” and “WAITING TIME” can be set for up to 12 hours and 45 minutes in units of 3 minutes.

SOFT FOCUS

Reduces edges and softens the image.

Example: Setting “SOFT FOCUS” to “2”

Perform Steps 1-2 of LONG LIFE, then...

3. Use the ▲ and ▼ buttons to select “SOFT FOCUS”.

4. Use the ◀ and ▶ buttons to select “2”.

The mode switches as follows each time the ◀ or ▶ button is pressed:

→OFF ↔ 1 ↔ 2 ↔ 3 ↔ 4

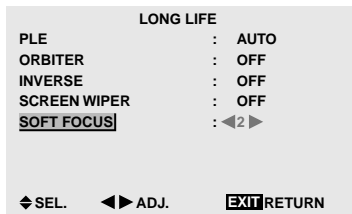

Information

■ SOFT FOCUS settings

OFF Turns the SOFT FOCUS function off.

1, 2, 3, 4 Activates the SOFT FOCUS setting. The higher numbers create a softer image. “SHARPNESS” can not be adjusted on the “PICTURE” menu.

Setting the gray level for the sides of the screen

Use this procedure to set the gray level for the parts on the screen on which nothing is displayed when the screen is set to the 4:3 size.

Example: Adjusting the “GRAY LEVEL”

Set “ADVANCED OSM” to “ON” in the main menu (1/2), then perform the following operations.

1. On the MAIN MENU, select “OPTION2”, then press the MENU/ENTER button.

The “OPTION2” screen appears.

2. Use the ▲ and ▼ buttons to select “GRAY LEVEL”.

3. To adjust the “GRAY LEVEL”...

Use the ◀ and ▶ buttons to adjust the GRAY LEVEL.

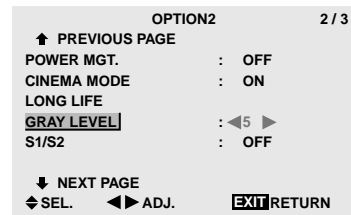

Information

■ GRAY LEVEL settings

This adjusts the brightness of the black (the gray level) for the sides of the screen.

The standard is 0 (black). The level can be adjusted from 0 to 15. The factory setting is 3 (dark gray).

■ Restoring the factory default settings

Select “ALL RESET” under the OPTION1 menu. Note that this also restores other settings to the factory defaults.

Setting the screen size for S1/S2 video input

If the S-video signal contains screen size information, the image will be automatically adjusted to fit the screen when this S1/S2 is set to AUTO.

This feature is available only when an S-video signal is input via the VIDEO3 terminal.

Example: Setting the “S1/S2” to “AUTO”

Set “ADVANCED OSM” to “ON” in the main menu (1/2), then perform the following operations.

1. On the MAIN MENU, select “OPTION2”, then press the MENU/ENTER button.

The “OPTION2” screen appears.

2. Use the ▲ and ▼ buttons to select “S1/S2”.

3. Use the ◀ and ▶ buttons to select “AUTO”.

The mode switches as follows each time the ◀ or ▶ button is pressed:

OFF ↔ AUTO

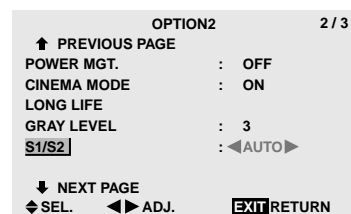

Information

■ S1/S2 settings

AUTOAdjusts the screen size automatically according to the S1/S2 video signal.
OFF Turns the S1/S2 function off.

■ Restoring the factory default settings

Select "ALL RESET" under the OPTION1 menu. Note that this also restores other settings to the factory defaults.

Setting the picture size for RGB input signals

Use this procedure to switch the setting to "ON" or "OFF".

Example: Setting the "PICTURE SIZE" mode to "OFF"

Set "ADVANCED OSM" to "ON" in the main menu (1/2), then perform the following operations.

1. On the MAIN MENU, select "OPTION2", then press the MENU/ENTER button.
The "OPTION2" screen appears.
2. Use the ▲ and ▼ buttons to select "PICTURE SIZE".
3. To set PICTURE SIZE mode to "OFF"....
Use the ◀ and ▶ buttons to select "OFF".
The mode switches as follows each time the ◀ or ▶ button is pressed:
ON ↔ OFF

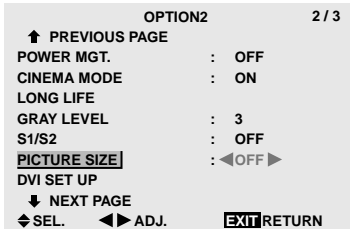

Information

■ Restoring the factory default settings

Select "ALL RESET" under the OPTION1 menu. Note that this also restores other settings to the factory defaults.

Setting the signal and black level for DVI signal

Choose the signal for the DVI connector (PC or STB/DVD) and set the black level.

Example: Setting the "PLUG/PLAY" mode to "STB/DVD"

Set "ADVANCED OSM" to "ON" in the main menu (1/2), then perform the following operations.

1. On the MAIN MENU, select "OPTION2", then press the MENU/ENTER button.
The "OPTION2" screen appears.
2. Use the ▲ and ▼ buttons to select "DVI SET UP", then press the MENU/ENTER button.
The "DVI SET UP" screen appears.

3. To set PLUG/PLAY mode to "STB/DVD"....
Use the ◀ and ▶ buttons to select "STB/DVD".
The mode switches as follows each time the ◀ or ▶ button is pressed:

PLUG/PLAY: PC ↔ STB/DVD

BLACK LEVEL: LOW ↔ HIGH

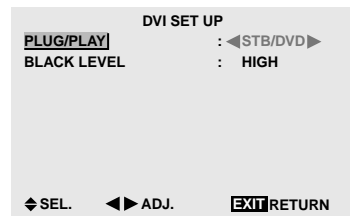

Information

■ PLUG/PLAY settings

PC When connected to the PC signal.
BLACK LEVEL is set to "LOW" automatically.

STB/DVD ... When connected to the SET TOP BOX, DVD etc.
BLACK LEVEL is set to "HIGH" automatically.

■ BLACK LEVEL settings

LOW When connected to the PC signal.
HIGH When connected to the SET TOP BOX, DVD etc. Change "HIGH" into "OFF" if the black level appears gray.

Option3 Settings Menu

Using the timer

This function sets the monitor to turn ON/OFF automatically at a set time.

Set "ADVANCED OSM" to "ON" in the main menu (1/2), then perform the following operations.

1. On the MAIN MENU, select "OPTION3", then press the MENU/ENTER button.
The "OPTION3" screen appears.
2. Use the ▲ and ▼ buttons to select "TIMER", then press the MENU/ENTER button.
The "TIMER" screen appears.

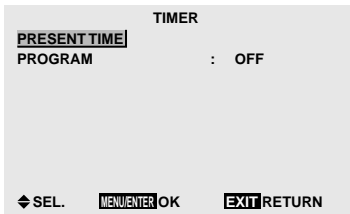

3. Set the TIMER using ▲▼◀ and ▶ buttons.
See page 32 to set PRESENT TIME.
See page 33 to set PROGRAM.

Information

Restoring the factory default settings

Select "ALL RESET" under the OPTION1 menu. Note that this also restores other settings to the factory defaults.

PRESENT TIME

This sets the day of the week and present time.

Example: Setting "WEDNESDAY", "22:05"

Perform Steps 1-2 of TIMER, then...

3. Use the ▲ and ▼ buttons to select "PRESENT TIME", then press the MENU/ENTER button.
The "PRESENT TIME" screen appears.

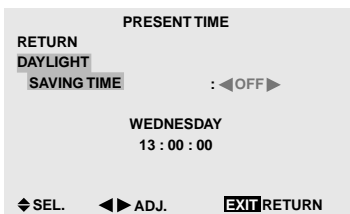

4. Use the ▲ and ▼ buttons to select the item, then adjust using the ◀ and ▶ buttons.



The mode switches as follows each time the ◀ or ▶ button is pressed:

- DAYLIGHT SAVING TIME

ON ↔ OFF

- Day

→ SUNDAY ↔ MONDAY ↔ ↔ FRIDAY ↔ SATURDAY ←

- Hour/Minutes

→ 00:00 ↔ 00:01 ↔ 00:02 ↔ ↔ 23:58 ↔ 23:59 ←

5. Once the setting is completed...

Use the ▲ and ▼ buttons to select "SET", then press the MENU/ENTER button.

The adjustments are stored and return to the TIMER menu.



Information

PRESENT TIME settings

DAYLIGHT SAVING TIME

..... Use to set DAYLIGHT SAVING TIME.

ON: The present time + 1 hour.

OFF: Cancelled

Day Set the day of the week (e.g. Sunday).

Hour Set the hour in the 24-hour format (range 00 to 23).

Minutes Set the minutes (range 00 to 59).

* If you press the EXIT button instead of the MENU/ENTER button in step 5, the settings can not be mode.

PROGRAM TIMER

This sets the day and time at which the power will be switched ON/OFF as well as the input mode.

Example: Setting so that the power will be switched on at 8:30 A.M., Monday, displaying RGB2 source, and switched off at 10:30 A.M.

Perform Steps 1-2 of *TIMER*, then...

- Use the ▲ and ▼ buttons to select “PROGRAM”.

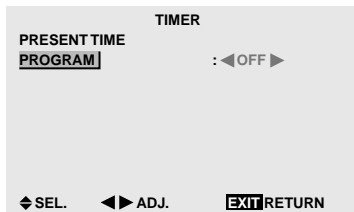

- Use the ◀ and ▶ buttons to select “ON”, then press the MENU/ENTER button. The “PROGRAM TIMER” screen appears.

- Adjust using the ▲▼◀ and ▶ buttons and ZOOM +/- button.

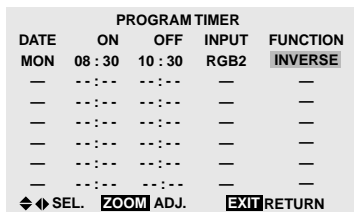

The mode switches as follows each time the ZOOM +/- button is pressed:

- Date
 → — ↔ SUN ↔ MON ↔ ... ↔ SAT ↔ * ↔ *SUN ↔ *MON ↔ ... ↔ *SAT ←
- ON/OFF Hour
 → 00 ↔ 01 ↔ 02 ↔ ↔ 21 ↔ 22 ↔ 23 ←
- Minute
 → 00 ↔ 01 ↔ 02 ↔ ↔ 57 ↔ 58 ↔ 59 ←
- INPUT
 → — ↔ LAST ↔ VIDEO1 ↔ VIDEO2 ↔ VIDEO3 ↔ HD/DVD1 ↔
 → RGB3 ↔ RGB2 ↔ RGB1 ↔ HD/DVD2 ←
- FUNCTION
 → — ↔ ORBITER ↔ INVERSE ↔ WHITE ↔ WIPER ←

Information

PROGRAM TIMER settings

- DATE Set the day of the week (e.g. Sunday).
- ON (hour, minutes) Set the time at which the power will be turned on in the 24-hour format.
- OFF (hour, minutes) ... Set the time at which the power will be turned off in the 24-hour format.
- INPUT Set the input mode that will be displayed when the timer is on.

FUNCTION Set the LONG LIFE function.

To reset the program

Align the cursor with the DATE field that you wish to reset, then press the CLEAR button.

To reset the data

Align the cursor with the field (ON/OFF/INPUT/FUNCTION) that you wish to reset, then press the CLEAR button.

Special characters in the PROGRAM TIMER screen

DATE	ON	OFF	INPUT	FUNCTION
MON	08:30	10:30	RGB2	INVERSE
TUE	--:--	18:15	—	—
SAT	08:30	12:15	VIDEO1	WHITE
*FRI	08:30	10:00	HD/DVD1	—
—	--:--	--:--	—	—
SAT	08:30	12:15	VIDEO1	WHITE
*	15:30	16:00	RGB1	—

- An asterisk “*” in the DATE field
 An asterisk “*” means “every”. For example, “*FRI” means every Friday and “*” means everyday.
- A hyphen “-” in the ON field or OFF field
 If any hyphen remains in the ON field or OFF field, the FUNCTION can not be set.
- A hyphen “.” in the FUNCTION field
 A hyphen “.” means last mode (the mode that was last selected at the time the power was switched off).

Setting the power on mode

This function sets the input mode at the time the power is switched on.

Example: Setting “VIDEO2”

Set “ADVANCED OSM” to “ON” in the main menu (1/2), then perform the following operations.

- On the MAIN MENU, select “OPTION3”, then press the MENU/ENTER button. The “OPTION3” screen appears.
- Use the ▲ and ▼ buttons to select “PWR. ON MODE”.
- To set the PWR. ON MODE to “VIDEO2”...
 Use the ◀ and ▶ buttons to select “VIDEO2”. The mode switches as follows each time the ◀ or ▶ button is pressed:
 The available inputs depend on the setting of “BNC INPUT”.

- RGB: → LAST ↔ VIDEO1 ↔ VIDEO2 ↔ VIDEO3 ↔
 → RGB3 ↔ RGB2 ↔ RGB1 ↔ HD/DVD1 ←
- COMP: → LAST ↔ VIDEO1 ↔ VIDEO2 ↔ VIDEO3 ↔
 → RGB3 ↔ RGB1 ↔ HD/DVD2 ↔ HD/DVD1 ←

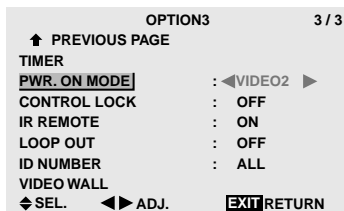

Information

■ PWR. ON MODE settings

LAST Last mode (the mode that was last selected at the time the power was switched off).

VIDEO1, 2, 3 VIDEO input mode.

RGB1, 2, 3 RGB input mode.

HD/DVD1, 2 HD/DVD input mode.

■ Restoring the factory default settings

Select "ALL RESET" under the OPTION1 menu. Note that this also restores other settings to the factory defaults.

Enabling/disabling the front panel controls

This function enables/disables the front panel controls.

Example: Setting "ON"

Set "ADVANCED OSM" to "ON" in the main menu (1/2), then perform the following operations.

1. On the MAIN MENU, select "OPTION3", then press the MENU/ENTER button.

The "OPTION3" screen appears.

2. Use the ▲ and ▼ buttons to select "CONTROL LOCK".

3. To set the CONTROL LOCK to "ON"...

Use the ◀ and ▶ buttons to select "ON", then press the MENU/ENTER button.

The mode switches as follows each time the ◀ or ▶ button is pressed:

OFF ↔ ON

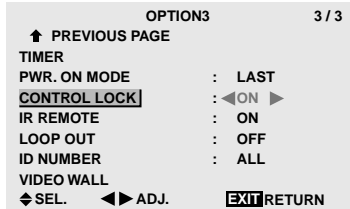

Information

■ CONTROL LOCK settings

ON Disables the buttons on the front panel.

OFF Enables the buttons on the front panel.

* Even when the CONTROL LOCK is set, the POWER switch will not be locked.

* This becomes effective when the on-screen menu goes out.

■ Restoring the factory default settings

Select "ALL RESET" under the OPTION1 menu. Note that this also restores other settings to the factory defaults.

Enabling/disabling remote control wireless transmission

This function enables/disables remote control wireless transmission.

Example: Setting "OFF"

Set "ADVANCED OSM" to "ON" in the main menu (1/2), then perform the following operations.

1. On the MAIN MENU, select "OPTION3", then press the MENU/ENTER button.

The "OPTION3" screen appears.

2. Use the ▲ and ▼ buttons to select "IR REMOTE".

3. To set the IR REMOTE to "OFF"...

Use the ◀ and ▶ buttons to select "OFF", then press the MENU/ENTER button.

The mode switches as follows each time the ◀ or ▶ button is pressed:

OFF ↔ ON

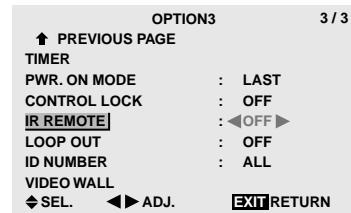

Information

■ IR REMOTE settings

ON Enables remote control wireless transmission.

OFF Disables remote control wireless transmission.

Set "OFF" to avoid unwanted control from other remote controls.

■ Restoring the factory default settings

Select "ALL RESET" under the OPTION1 menu. Note that this also restores other settings to the factory defaults.

Loop Out setting

When this feature is set to ON, the received signal will be looped out.

Example: Setting "ON"

Set "ADVANCED OSM" to "ON" in the main menu (1/2), then perform the following operations.

1. On the MAIN MENU, select "OPTION3", then press the MENU/ENTER button.

The "OPTION3" screen appears.

2. Use the ▲ and ▼ buttons to select "LOOP OUT".

3. To set the LOOP OUT to "ON"...

Use the ◀ and ▶ buttons to select "ON".

The mode switches as follows each time the ◀ or ▶ button is pressed:

OFF ↔ ON

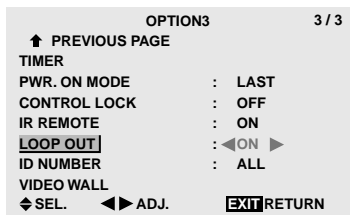

Information

■ LOOP OUT settings

ON The received signal will be looped out via PC1 terminal or VIDEO1 terminal.

OFF The received signal will not loop out.

* Even if LOOP OUT is ON, signals won't be sent out if POWER is being turned off.

■ To connect another display...

See page 10.

■ If the RGB/PC1 signal is present at the time the power switched on...

The RGB/PC1 input will be displayed regardless of the setting of LOOP OUT.

■ Restoring the factory default settings

Select "ALL RESET" under the OPTION1 menu. Note that this also restores other settings to the factory defaults.

ID number setting

When using more than one of these displays, this function sets ID numbers so that operation of the remote control does not cause multiple monitors to operate at the same time.

Example: Setting "2"

Set "ADVANCED OSM" to "ON" in the main menu (1/2), then perform the following operations.

1. On the MAIN MENU, select "OPTION3", then press the MENU/ENTER button.

The "OPTION3" screen appears.

2. Use the ▲ and ▼ buttons to select "ID NUMBER".

3. To set the ID NUMBER to "2"...

Use the ◀ and ▶ buttons to select "2".

The mode switches as follows each time the ◀ or ▶

button is pressed:

→ALL ↔ 1 ↔ 2 ↔ ↔ 255 ↔ 256←

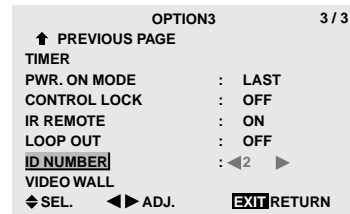

* To reset back to ALL

Press the CLEAR button.

Information

■ ID NUMBER settings

ALL ID NUMBER will not be set.

1 to 256 ID NUMBER will be set.

■ When the ID NUMBER have been set

You can also set ID NUMBER for each remote control to operate the plasma display individually. To do so, see below.

■ Restoring the factory default settings

Select "ALL RESET" under the OPTION1 menu. Note that this also restores other settings to the factory defaults.

To set the ID number for the remote control

Example: Setting "2"

1. Press the ID SELECT button on the remote control. The "ID SELECT" screen appears.

2. Use the ▲ and ▼ buttons to select "ID NUMBER".

3. To set the ID NUMBER to "2"...

Use the ◀ and ▶ buttons to select "2".

The mode switches as follows each time the ◀ or ▶ button is pressed:

→ALL ↔ 1 ↔ 2 ↔ ↔ 255 ↔ 256←

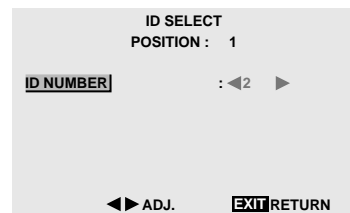

* To reset back to ALL

Press the CLEAR button.

4. Once the setting is completed...

Press the EXIT button to delete the ID SELECT screen.

Video Wall setting

Use this feature to configure a 2x2 or 3x3 video wall.

Set "ADVANCED OSM" to "ON" in the main menu (1/2), then perform the following operations.

1. On the MAIN MENU, select "OPTION3", then press the MENU/ENTER button.
The "OPTION3" screen appears.
2. Use the ▲ and ▼ buttons to select "VIDEO WALL", then press the MENU/ENTER button.
The "VIDEO WALL" screen appears.



3. Set the VIDEO WALL using ▲▼◀▶ and ▶ buttons.
See page 36 to set DIVIDER.
See page 36 to set POSITION.
See page 37 to set DISP. MODE.
See page 37 to set AUTO ID.
See page 37 to set IMAGE ADJUST.
See page 38 to set P. ON DELAY.
See page 38 to set PLE LINK.
See page 39 to set REPEAT TIMER.
4. Once the setting is completed...
Press the EXIT button to return to the OPTION3 menu.

Note: A contingency method of shutting off the electric power should be used in cases of emergency during video wall setup.

Information

Restoring the factory default settings

Select "ALL RESET" under the OPTION1 menu. Note that this also restores other settings to the factory defaults.

DIVIDER

Set the 2x2 or 3x3 video wall.

Example: Setting "4"

Perform Steps 1-2 of VIDEO WALL, then...

3. Use the ▲ and ▼ buttons to select "DIVIDER".
4. Use the ◀ and ▶ buttons to select "4".
The mode switches as follows each time the ◀ or ▶ button is pressed:

→ OFF ↔ 1 ↔ 4 ↔ 9 ←



Information

DIVIDER settings

OFF, 1 1 Screen (Matrix display function does not work)

4 4 Screens (2x2 video wall)

9 9 Screens (3x3 video wall)

* When you select "4" or "9", set the VIDEO WALL POSITION.

VIDEO WALL POSITION

Set the position of each display.

Example: Setting "4"

Perform Steps 1-2 of VIDEO WALL, then...

3. Use the ▲ and ▼ buttons to select "POSITION", then press the MENU/ENTER button.
The "VIDEO WALL POSITION" screen appears.
4. Use the ◀ and ▶ buttons to select "NO. 4".
The mode switches as follows each time the ◀ or ▶ button is pressed:

• 4 Screens

→ NO. 1 ↔ NO. 2 ↔ NO. 3 ↔ NO. 4 ←

• 9 Screens

→ NO. 7 ↔ NO. 8 ↔ ↔ NO. 14 ↔ NO. 15 ←

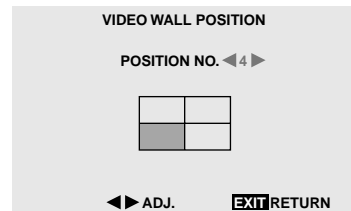

Information

VIDEO WALL POSITION settings

1 Screen There is no need to set POSITION.

4 Screens

NO. 1	NO. 2
NO. 4	NO. 3

9 Screens

NO. 7	NO. 8	NO. 9
NO. 10	NO. 11	NO. 12
NO. 13	NO. 14	NO. 15

DISP. MODE

Select the screen mode from between two options (Splitting, Blanking).

Example: Setting "BLANK"

Perform Steps 1-2 of VIDEO WALL, then...

- Use the ▲ and ▼ buttons to select "DISP. MODE".
- Use the ◀ and ▶ buttons to select "BLANK".
The mode switches as follows each time the ◀ or ▶ button is pressed:

SPLIT ↔ BLANK

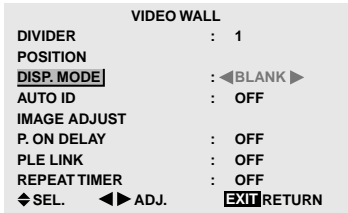

Information

■ DISP. MODE settings

SPLIT Combines enlarged screens and creates multiple screens.

BLANK Corrects misalignment of combined screen portions and creates multiple screens

AUTO ID

This feature automatically sets the ID numbers of multiple displays connected to each other.

Example: Setting "ON"

Set the ID number for the No. 1 display on ID NUMBER menu.

Perform Steps 1-2 of VIDEO WALL, then...

- Use the ▲ and ▼ buttons to select "AUTO ID".
- Use the ◀ and ▶ buttons to select "ON", then press the MENU/ENTER button.
The mode switches as follows each time the ◀ or ▶ button is pressed:

OFF ↔ ON

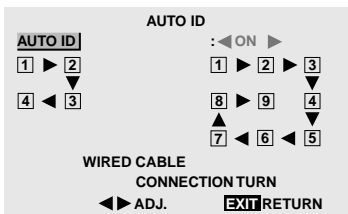

Information

■ AUTO ID settings

ON Enables Auto ID function. In the case shown below, display 1 will be set as ID 1, display 2 as ID2, etc.

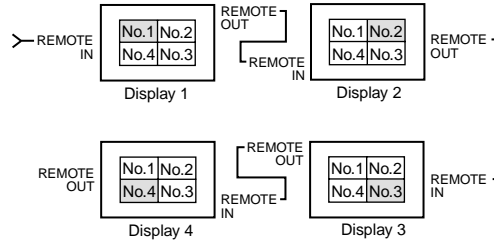

OFF Disables Auto ID function.

IMAGE ADJUST

The position of the image can be adjusted and flickering of the image can be corrected.

Example: Adjusting the vertical position

Perform Steps 1-2 of VIDEO WALL, then...

- Use the ▲ and ▼ buttons to select "IMAGE ADJUST", then press the MENU/ENTER button.
The "IMAGE ADJUST" screen appears.
- Use the ▲ and ▼ buttons to select "V-POSITION".

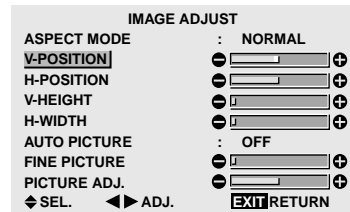

- Adjust using the ◀ and ▶ buttons.



* If neither the ◀ or ▶ button is pressed within 5 seconds, the current setting is set and the previous screen reappears.

Information

■ IMAGE ADJUST settings

These are the same functions as the IMAGE ADJUST menu on page 22.

P. ON DELAY (Power on delay)

Use this function to activate power-on delay.
Turn on the AUTO ID before the following operations.

Example: Setting "ON"

Perform Steps 1-2 of VIDEO WALL, then...

- Use the ▲ and ▼ buttons to select "P. ON DELAY".
- Use the ◀ and ▶ buttons to select "ON".
The mode switches as follows each time the ◀ or ▶ button is pressed:

OFF ↔ ON

VIDEO WALL	
DIVIDER	: 1
POSITION	
DISP. MODE	: SPLIT
AUTO ID	: OFF
IMAGE ADJUST	
P. ON DELAY	: ◀ ON ▶
PLE LINK	: OFF
REPEAT TIMER	: OFF
◆SEL. ◀▶ADJ. EXITRETURN	

Information

■ P. ON DELAY settings

ON Turns on the main power of each display after a delay time.

OFF Turns on the main power of all displays at the same time.

* Once this function has been set to "ON", POWER ON/OFF button on the remote control does not function except for the No.1 monitor.

By pressing the POWER ON button on the remote control the No.1 monitor will turn on and the others will be turned on one by one automatically.

* From the second monitor onward, neither the POWER button on the unit nor the POWER ON button on the remote control does function. However, by pressing and holding the POWER ON button for more than 3 seconds, the monitor will be turned on.

PLE LINK

Use this function to set a uniform brightness for each display.

Turn on the AUTO ID and set the DIVIDER (at 1, 4 or 9) before the following operations.

Example: Setting "ON"

Perform Steps 1-2 of VIDEO WALL, then...

- Use the ▲ and ▼ buttons to select "PLE LINK".
- Use the ◀ and ▶ buttons to select "ON", then press the MENU/ENTER button.
The mode switches as follows each time the ◀ or ▶ button is pressed:

OFF ↔ ON

VIDEO WALL	
DIVIDER	: 1
POSITION	
DISP. MODE	: SPLIT
AUTO ID	: OFF
IMAGE ADJUST	
P. ON DELAY	: OFF
PLE LINK	: ◀ ON ▶
REPEAT TIMER	: OFF
◆SEL. ◀▶ADJ. EXITRETURN	

Information

■ PLE LINK settings

ON Sets a uniform brightness for each screen in a video wall.

OFF Sets the individual screen brightness for each screen in a video wall.

* When this function is set "ON", connect your plasma displays with the remote cable (optional) in the order of the position numbers for the 2×2 video wall. See the drawing below.

* If there are changes in the DIVIDER or POSITION, the PLE LINK will automatically turn OFF.

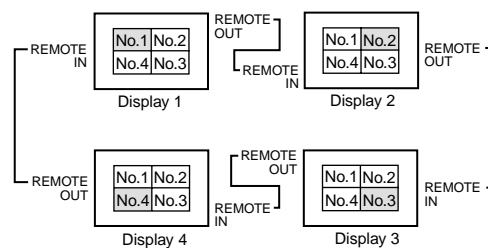

* With the 3×3 video wall, connect the final display to the first display the same way as with 2×2 video wall.

Note: The remote control can be operated unless the IR REMOTE is set to "OFF".

REPEAT TIMER

Use this to set two timers. Each timer can use the DIVIDER, SOURCE and WORK TIME functions.

Turn on the AUTO ID and set the DIVIDER (at 1, 4 or 9) before the following operations.

Example:

TIMER1...VIDEO1 will be displayed for 3 minutes.
 TIMER2...RGB1 will be displayed for 6 minutes in a 2x2 video wall.

Perform Steps 1-2 of VIDEO WALL, then...

3. Use the ▲ and ▼ buttons to select “REPEAT TIMER”.

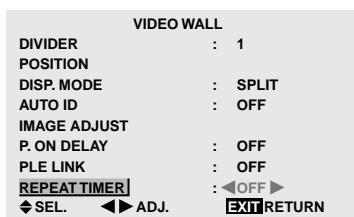

4. Use the ◀ and ▶ buttons to select “ON”, then press the MENU/ENTER button.

The “REPEAT TIMER” screen appears.

5. Adjust using the ▲▼◀ and ▶ buttons.

The mode switches as follows each time the ◀ or ▶ button is pressed:



• DIVIDER

→ 1 ↔ 4 ↔ 9 ←

• SOURCE

The available sources depend on the setting of “BNC INPUT”.

→ VIDEO1 ↔ VIDEO2 ↔ VIDEO3 ↔ HD/DVD1 ←

→ RGB3 ↔ RGB2 ↔ RGB1 ↔ HD/DVD2 ←

• WORK TIME

→ 00H01M ↔ 00H02M ↔ 00H03M ↔ ↔ 04H14M ↔ 04H15M ←

Information

■ REPEAT TIMER settings

If you set both timers, Timer 1 and Timer 2 run consecutively.

In the case of the Video wall, timer No.1 can be used to control all the displays simultaneously.

* This becomes effective when the on-screen menu goes out.

Advanced OSM Settings Menu

Setting the menu mode

This allows you to access full menu items.

When P. ON DELAY or PLE LINK is ON, this won't be turned OFF.

Example: Setting “ON”

1. On the MAIN MENU, select “ADVANCED OSM”.

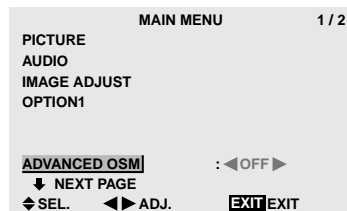

2. To set the ADVANCED OSM to “ON”...

Use the ◀ and ▶ buttons to select “ON”.

The mode switches as follows each time the ◀ or ▶ button is pressed:

OFF ↔ ON

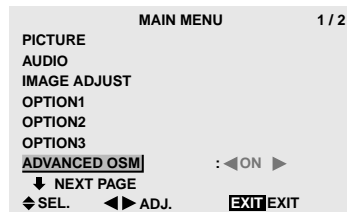

Information

■ ADVANCED OSM settings

ON All of the main menu items are available for advanced users.

OFF Some of the main menu items are not available (e.g. OPTION2, OPTION3).

■ Restoring the factory default settings

Select “ALL RESET” under the OPTION1 menu. Note that this also restores other settings to the factory defaults.

Language Settings Menu

Setting the language for the menus

The menu display can be set to one of seven languages: English, German, French, Swedish, Italian, Spanish or Chinese.

Example: Setting the menu display to “DEUTSCH”

1. On the MAIN MENU, select “LANGUAGE”, then press the MENU/ENTER button.
The “LANGUAGE” screen appears.
2. To select “DEUTSCH” ...
Use the ◀ and ▶ buttons to select “DEUTSCH”.
The mode switches as follows each time the ◀ or ▶ buttons is pressed:

→ ENGLISH ↔ DEUTSCH ↔ FRANÇAIS ←
→ 中文 ↔ SVENSKA ↔ ITALIANO ↔ ESPAÑOL ←

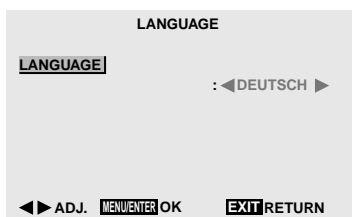

Information

■ Language settings

ENGLISH English
 DEUTSCH German
 FRANÇAIS French
 ESPAÑOL Spanish
 ITALIANO Italian
 SVENSKA Swedish
 中文 Chinese

Color System Settings Menu

Setting the video signal format

Use these operations to set the color systems of composite video signals or Y/C input signals.

Example: Setting the color system to “3.58 NTSC”

1. On the MAIN MENU, select “COLOR SYSTEM”, then press the MENU/ENTER button.
The “COLOR SYSTEM” screen appears.
2. To select “3.58NTSC” ...
Use the ◀ and ▶ buttons to select “3.58NTSC”.
The mode switches as follows each time the ◀ or ▶ button is pressed:

→ AUTO ↔ 3.58NTSC ↔ 4.43NTSC ←
→ SECAM ↔ PAL-M ↔ PAL-N ↔ PAL60 ↔ PAL ←

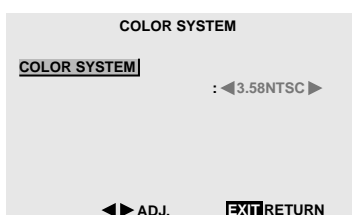

Information

■ Video signal formats

Different countries use different formats for video signals. Set to the color system used in your current country.

AUTO The color systems are automatically identified and the format is set accordingly.

PAL This is the standard format used mainly in the United Kingdom and Germany.

SECAM This is the standard format used mainly in France and Russia.

4.43 NTSC,

PAL60 This format is used for videos in countries using PAL and SECAM video signals.

3.58 NTSC This is the standard format used mainly in the United States and Japan.

PAL-M This is the standard format used mainly in Brazil.

PAL-N This is the standard format used mainly in Argentina.

Source Information Menu

Checking the frequencies, polarities of input signals, and resolution

Use this function to check the frequencies and polarities of the signals currently being input from a computer, etc.

Press the MENU/ENTER button on the remote control to display the MAIN MENU on the screen, then...

1. On the MAIN MENU, select “SOURCE INFORMATION”, then press the MENU/ENTER button.
2. The “SOURCE INFORMATION” is displayed.

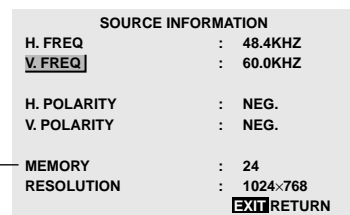

PC: MEMORY will be displayed.
 Others: MODE will be displayed.

External Control

Application

These specifications cover the communications control of the plasma monitor by external equipment.

Connections

Connections are made as described below.

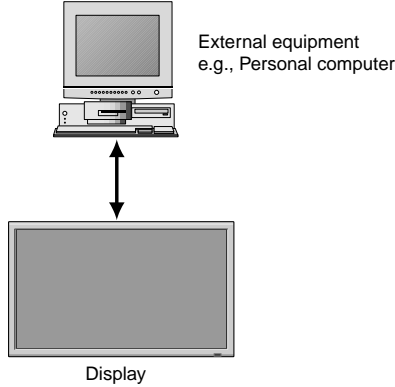

Connector on the plasma monitor side: EXTERNAL CONTROL connector.

Use a crossed (reverse) cable.

Type of connector: D-Sub 9-pin male

Pin No.	Pin Name
1	No Connection
2	RXD (Receive data)
3	TXD (Transmit data)
4	DTR (DTE side ready)
5	GND
6	DSR (DCE side ready)
7	RTS (Ready to send)
8	CTS (Clear to send)
9	No connection

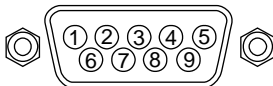

Communication Parameters

- | | |
|--------------------------|--------------|
| (1) Communication system | Asynchronous |
| (2) Interface | RS-232C |
| (3) Baud rate | 9600 bps |
| (4) Data length | 8 bits |
| (5) Parity | Odd |
| (6) Stop bit | 1 bit |
| (7) Communication code | Hex |

External Control Codes (Reference)

FUNCTION		CODE DATA							
		9FH	80H	60H	4EH	00H	CDH		
Power ON	ON	9FH	80H	60H	4EH	00H	CDH		
	OFF	9FH	80H	60H	4FH	00H	CEH		
Input Switch	Video1 (BNC)	DFH	80H	60H	47H	01H	08H		
	Video2 (RCA)	DFH	80H	60H	47H	01H	02H	09H	
	Video3 (S-Video)	DFH	80H	60H	47H	01H	03H	0AH	
	DVD1/HD1 (RCA)	DFH	80H	60H	47H	01H	05H	0CH	
	DVD2/HD2 (BNC)	DFH	80H	60H	47H	01H	06H	0DH	
	RGB1 (mini D-sub 15-pin)	DFH	80H	60H	47H	01H	07H	0EH	
	RGB2 (5BNC)	DFH	80H	60H	47H	01H	08H	0FH	
RGB3 (DVI)	DFH	80H	60H	47H	01H	0CH	13H		
Audio Mute	ON	9FH	80H	60H	3EH	00H	BDH		
	OFF	9FH	80H	60H	3FH	00H	BEH		
Picture Mode	NORMAL	DFH	80H	60H	0AH	01H	01H	CBH	
	THEAT. 1	DFH	80H	60H	0AH	01H	02H	CCH	
	THEAT. 2	DFH	80H	60H	0AH	01H	03H	CDH	
	DEFAULT	DFH	80H	60H	0AH	01H	04H	CEH	
Screen Mode	STADIUM	DFH	80H	60H	51H	01H	02H	13H	
	ZOOM	DFH	80H	60H	51H	01H	03H	14H	
	NORMAL	DFH	80H	60H	51H	01H	04H	15H	
	FULL	DFH	80H	60H	51H	01H	05H	16H	
	14 : 9	DFH	80H	60H	51H	01H	09H	1AH	
	2.35 : 1	DFH	80H	60H	51H	01H	0AH	1BH	
Auto Picture	ON	DFH	80H	60H	7FH	03H	03H	09H	00H 4DH
	OFF	DFH	80H	60H	7FH	03H	03H	09H	01H 4EH
Cinema Mode	ON	DFH	80H	60H	C1H	01H	01H	82H	
	OFF	DFH	80H	60H	C1H	01H	02H	83H	

Note: Contact your local dealer for a full list of the External Control Codes if needed.

Troubleshooting

If the picture quality is poor or there is some other problem, check the adjustments, operations, etc., before requesting service.

Symptom	Checks	Remedy
Mechanical sound is heard.	<ul style="list-style-type: none"> • Maybe the sound from the cooling fans used to prevent over heating. 	
The unit emits a crackling sound.	<ul style="list-style-type: none"> • Are the image and sound normal? 	<ul style="list-style-type: none"> • If there are no abnormalities in the image and sound, the noise is caused by the cabinet reacting to changes in humidity. This will not affect performance.
Picture is disturbed. Sound is noisy. Remote control operates erroneously.	<ul style="list-style-type: none"> • Is a connected component set directly in front or at the side of the display? 	<ul style="list-style-type: none"> • Leave some space between the display and the connected components.
The remote control does not work.	<ul style="list-style-type: none"> • Are the remote control's batteries worn out? 	<ul style="list-style-type: none"> • Replace both batteries with new ones.
	<ul style="list-style-type: none"> • Is IR REMOTE set to ON? 	<ul style="list-style-type: none"> • Set IR REMOTE OFF on OPTION3 menu.
	<ul style="list-style-type: none"> • Has an ID number been set for the main unit? 	<ul style="list-style-type: none"> • Set an ID number with the ID SELECT button, or set the ID number to ALL.
Monitor's power does not turn on when the remote control's power button is pressed.	<ul style="list-style-type: none"> • Is the monitor's power cord plugged into a power outlet? 	<ul style="list-style-type: none"> • Plug the monitor's power cord into a power outlet.
	<ul style="list-style-type: none"> • Are all the monitor's indicators off? 	<ul style="list-style-type: none"> • Press the power button on the monitor to turn on the power.
	<ul style="list-style-type: none"> • Are the remote control's batteries worn out? 	<ul style="list-style-type: none"> • Replace both batteries with new ones.
	<ul style="list-style-type: none"> • Is IR REMOTE set to ON? 	<ul style="list-style-type: none"> • Set IR REMOTE OFF.
Monitor does not operate when the remote control's buttons are pressed.	<ul style="list-style-type: none"> • Has an ID number been set for the main unit? 	<ul style="list-style-type: none"> • Set an ID number with the ID SELECT button, or set the ID number to ALL.
	<ul style="list-style-type: none"> • Is the remote control pointed at the monitor, or is there an obstacle between the remote control and the monitor? 	<ul style="list-style-type: none"> • Point the remote control at the monitor's remote control sensor when pressing buttons, or remove the obstacle.
	<ul style="list-style-type: none"> • Is direct sunlight or strong artificial light shining on the monitor's remote control sensor? 	<ul style="list-style-type: none"> • Eliminate the light by closing curtains, pointing the light in a different direction, etc.
	<ul style="list-style-type: none"> • Are the remote control's batteries worn out? 	<ul style="list-style-type: none"> • Replace both batteries with new ones.
The front panel buttons of the main unit do not function.	<ul style="list-style-type: none"> • The remote cable is plugged into the REMOTE IN terminal (Wired). 	<ul style="list-style-type: none"> • Unplug the remote cable from the monitor.
The front panel buttons of the main unit do not function.	<ul style="list-style-type: none"> • The front panel buttons do not function during Control Lock. 	<ul style="list-style-type: none"> • Set the Control Lock to OFF.
No sound or picture is produced.	<ul style="list-style-type: none"> • Is the monitor's power cord plugged into a power outlet? 	<ul style="list-style-type: none"> • Plug the monitor's power cord into a power outlet.
Picture appears but no sound is produced.	<ul style="list-style-type: none"> • Is the volume set at the minimum? 	<ul style="list-style-type: none"> • Increase the volume.
	<ul style="list-style-type: none"> • Is the mute mode set? 	<ul style="list-style-type: none"> • Press the remote control's MUTE button.
	<ul style="list-style-type: none"> • Are the speakers properly connected? 	<ul style="list-style-type: none"> • Connect the speakers properly.
	<ul style="list-style-type: none"> • Is AUDIO INPUT set correctly? 	<ul style="list-style-type: none"> • Set AUDIO INPUT on the AUDIO menu correctly.
Poor picture with VIDEO signal input.	<ul style="list-style-type: none"> • Improper control setting. • Local interference. • Cable interconnections. • Input impedance is not correct level. 	<ul style="list-style-type: none"> • Adjust picture control as needed. • Try another location for the monitor. • Be sure all connections are secure.
Poor picture with RGB signal input.	<ul style="list-style-type: none"> • Improper control setting. • Incorrect 15 PIN connector pin connections. 	<ul style="list-style-type: none"> • Adjust picture controls as needed. • Check pin assignments and connections.
Tint is poor or colors are weak.	<ul style="list-style-type: none"> • Are the tint and colors properly adjusted? 	<ul style="list-style-type: none"> • Adjust the tint and color (under PICTURE).
Nothing appears on screen.	<ul style="list-style-type: none"> • Is the computer's power turned on? 	<ul style="list-style-type: none"> • Turn on the computer's power.
	<ul style="list-style-type: none"> • Is a source connected? 	<ul style="list-style-type: none"> • Connect source to the monitor.
	<ul style="list-style-type: none"> • Is the power management function in the standby or off mode? 	<ul style="list-style-type: none"> • Operate the computer (move the mouse, etc.).
	<ul style="list-style-type: none"> • Is LOOP OUT set to ON? 	<ul style="list-style-type: none"> • Set LOOP OUT OFF.
Part of picture is cut off or picture is not centered.	<ul style="list-style-type: none"> • Is the position adjustment appropriate? 	<ul style="list-style-type: none"> • Adjust the IMAGE ADJUST properly.
Image is too large or too small.	<ul style="list-style-type: none"> • Is the screen size adjustment appropriate? 	<ul style="list-style-type: none"> • Press the WIDE button on the remote control and adjust properly.
Picture is unstable.	<ul style="list-style-type: none"> • Is the computer's resolution setting appropriate? 	<ul style="list-style-type: none"> • Set to the proper resolution.
POWER/STANDBY indicator is lighted in red.	<ul style="list-style-type: none"> • Horizontal and / or vertical sync signal is not present when the Intelligent Power Manager control is on. 	<ul style="list-style-type: none"> • Check the input signal.
POWER/STANDBY indicator is blinking in red.	<ul style="list-style-type: none"> • The temperature inside the main unit has become too high and has activated the protector. 	<ul style="list-style-type: none"> • Promptly switch off the power of the main unit and wait until the internal temperature drops. See*1.
POWER/STANDBY indicator is blinking in green and red, or green.	<p style="text-align: center;">—————</p>	<ul style="list-style-type: none"> • Promptly switch off the power of the main unit. See *2.

*1 Overheat protector

If the monitor becomes too hot, the overheat protector will be activated and the monitor will be turned off. If this happens, turn off the power to the monitor and unplug the power cord. If the room where the monitor is installed is particularly hot, move the monitor to a cooler location and wait for the monitor to cool for 60 minutes. If the problem persists, contact your dealer.

*2 In the following case, power off the monitor immediately and contact your dealer or authorized Marantz Service Center.

The monitor turns off 5 seconds after powering on and then the POWER/STANDBY indicator blinks. It indicates that the power supply circuit, plasma display panel, temperature sensor, or one or more fans have been damaged.

marantz®

Model PD4220V Information

Plasma Monitor

Important Information

Warning

Not for use in a computer room as defined in the Standard for the Protection of Electronic Computer/ Data Processing Equipment ANSI/NFPA 75.

This equipment has been tested and found to comply with the limits for a Class A digital device, pursuant to Part 15 of the FCC Rules. These limits are designed to provide reasonable protection against harmful interference when the equipment is operated in a commercial environment. This equipment generates, uses, and can radiate radio frequency energy and, if not installed and used in accordance with the instruction manual, may cause harmful interference to radio communications. Operation of this equipment in a residential area is likely to cause harmful interference in which case the user will be required to correct the interference at his own expense.

This is a Class A product. In a domestic environment, this product may cause radio interference in which case the user may be required to take adequate measures.

NOTE:

When you connect a computer to this monitor, use an RGB cable including the ferrite core on both ends of the cable. And regarding DVI and power cable, attach the supplied ferrite cores. If you do not do this, this monitor will not conform to mandatory FCC or C-Tick standards.

Attaching the ferrite cores:

Set the ferrite cores on both ends of the DVI cable (not supplied), and both ends of the power cable (supplied). Close the lid tightly until the clamps click.

Use the band to fasten the ferrite core (supplied) to the DVI cable.

DVI cable (not supplied)



Power cable (supplied)

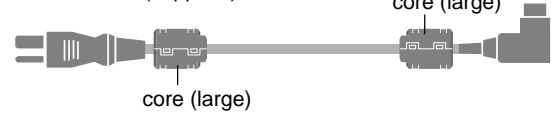

Recommandations importantes

Avertissement

Ne pas utiliser dans une salle d'ordinateurs telle que définie dans la Norme pour la protection des ordinateurs électroniques/appareils de traitement des données ANSI/NFPA75.

DOC avis de conformation

Cet appareil numérique de la Classe A respecte toutes les exigences du Règlement sur le Matériel Brouilleur du Canada.

REMARQUE:

Pour raccorder un ordinateur à ce moniteur, procéder à l'aide d'un câble RGB à âme de ferrite aux deux extrémités. Sur les câbles DVI et les câbles d'alimentation électrique, fixer les âmes de ferrite fournies aux extrémités. Si vous ne le faites, le moniteur ne sera pas en conformité avec les exigences des standards FCC.

Fixation des noyaux en ferrite.

Monter les tores en ferrite aux deux extrémités du câble DVI (non fourni) et aux deux extrémités du câble d'alimentation électrique (fourni).

Fermez doucement le couvercle jusqu'à ce que les crans se clipsent.

Fixer le tore en ferrite (fourni) au câble DVI à l'aide d'un collier.

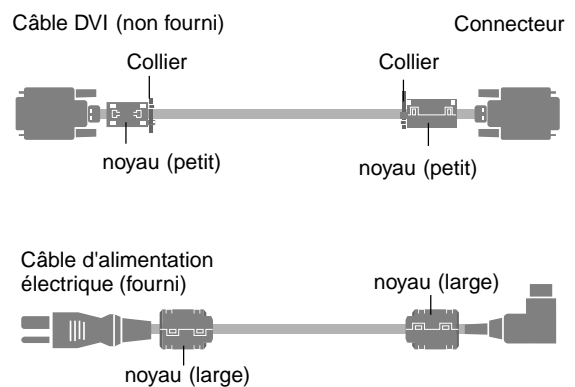

Specifications

Screen Size	36.3"(H)×20.4"(V) inches 921(H)×518(V) mm diagonal 42"
Aspect Ratio	16 : 9
Resolution	853(H)×480(V) pixels
Pixel Pitch	0.04"(H)×0.04"(V) inches 1.08(H)×1.08(V) mm
Color Reproduction	256 levels, 16,770,000 colors
Signals	
Synchronization Range	Horizontal : 15.5 to 110 kHz (automatic : step scan) Vertical : 50.0 to 120 Hz (automatic : step scan)
Input Signals	RGB, NTSC (3.58/4.43), PAL (B,G,M,N), PAL60, SECAM, HD* ¹ , DVD* ¹ , DTV* ¹
Input Terminals (VIDEO1 and RGB1 can also be used as OUTPUT terminals)	
RGB	
Visual 1 (Analog)	mini D-sub 15-pin × 1
Visual 2 (Analog)	BNC (R, G, B, H/CS, V) × 1* ²
Visual 3 (Digital)	DVI-I 24-pin × 1* ³
Video	
Visual 1	BNC × 1
Visual 2	RCA-pin × 1
Visual 3	S-Video: DIN 4-pin × 1
DVD/HD/DTV	
Visual 1	RCA-pin (Y, PB[CB], PR[CR]) × 1* ¹
Visual 2	BNC (Y, PB[CB], PR[CR]) × 1* ^{1, *2}
Audio	Stereo RCA × 3(Selectable)
External Control	D-sub 9-pin × 1(RS-232C)
Sound output	8W+8W at 6 ohm
Power Supply	Current Rating
AC120V 50/60Hz	3.7A (maximum)
AC100-240V 50/60Hz	4.5A (maximum)
Power Consumption	270W (typical)
Dimensions	40 (W)×24 (H)×3.5 (D) inches 1018 (W)×610 (H)×89(D) mm
Weight	62.8 lbs / 28.5 kg (without stand)
Environmental Considerations	
Operating Temperature	0°C to 40°C / 32°F to 104°F
Humidity	20 to 80% (no condensation)
Altitude	0 to 9180 feet / 0 to 2800 m
Storage Temperature	-10°C to 50°C / 14°F to 122°F
Humidity	10 to 90% (no condensation)
Altitude	0 to 9840 feet / 0 to 3000 m
Front Panel User Controls	Power on/off, Input source select, Volume up/down, OSM control
Remote Control Functions	Power on/off, Input source select, OSM control, Volume up/down, Cursor (UP, DOWN, LEFT, RIGHT), Pointer, Zoom up/ down, Off timer, Wireless/Wired remote control
OSM Functions	Picture (Contrast/Brightness/Sharpness/ Color/Tint/ Picture mode/Noise reduction/ Color temperature/ White balance/ Gamma/Low tone/Color tune), Audio (Bass/Treble/Balance/Audio input), Image Adjust (Aspect mode/V-Position /H-Position/ V-Height /H-Width/Auto Picture/Fine picture/ Picture adjustment), Option1 (OSM/BNC Input/D-Sub Input/RGB Select/HD Select/ Input Skip/All Reset), Option2 (Power management/Cinema mode/Long life [PLE, Orbiter, Inverse, White, Screen wiper, Soft focus]/Gray level/S1/S2), Option3 (Timer/Power on mode/Control lock/ IR Remote/Loop out/ID number/Video wall [Divider, Position, Disp. mode, Auto ID, Image adjust, Power on delay, PLE link, Timer]), Advanced OSM, Language*, Color system, Source information *English, German, French, Italian, Spanish, Swedish, Chinese

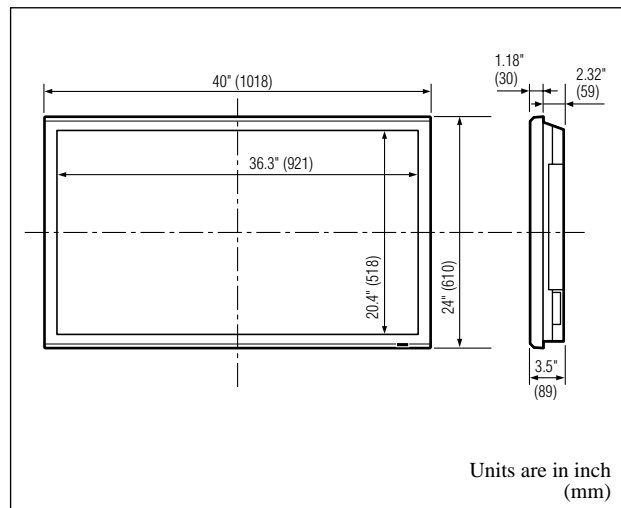

Units are in inch (mm)

The features and specifications may be subject to change without notice.

*¹ HD/DVD/DTV input signals supported on this system

480P (60 Hz)	480I (60 Hz)
525P (60 Hz)	525I (60 Hz)
576P (50 Hz)	576I (50 Hz)
625P (50 Hz)	625I (50 Hz)
720P (60 Hz)	1035I (60 Hz)
1080I (50 Hz)	1080I (60 Hz)

*² The 5-BNC connectors are used as RGB/PC2 and HD/DVD2 input. Select one of them under "BNC INPUT".

*³ Not compatible with HDCP.

When HDCP encrypted signal is selected, picture is not produced or disturbed periodically.

Other Features	Motion compensated 3D Scan Converter (NTSC, PAL, 480I, 576I, 525I, 625I, 1035I, 1080I), 2-3 pull down Converter (NTSC, 480I, 525I, 1035I, 1080I (60Hz)), 2-2 pull down Converter (PAL, 576I, 625I, NTSC, 480I, 525I), Digital Zoom Function (100-900% Selectable), Video Wall 2×2/3×3 multi screen, Self Diagnosis, Anti Image Burn (PLE LOCK1~3, INVERSE, WHITE, ORBITER (Auto1,2/Manual), SCREEN WIPER), Color Temperature select (high/mid/mid low/low, user has 4 memories), Control lock (Except power SW), Auto Picture, Input Skip, Color Tune, Low Tone (3 mode), Auto ID, Programmable Timer, Gamma Correction (4 mode), Loop through interface, Plug and play (DDC1, DDC2b, RGB3: DDC2b only)
Accessories	Remote control with two AAA batteries, Power cord, Manuals, Safety metal fitting parts, Ferrite cores, Bands
Regulations	UL Approved (UL 60950/CSA C22.2 No.60950-00) DOC Canada requirements SEMKO Approved(EN60950) Meets FCC Class A requirements Meets AS/NZS CISPR 22:2002 Class A

Table of Signals Supported

■ 42Wide VGA Supported resolution

- When the screen mode is NORMAL, each signal is converted to a 640 dots × 480 lines signal (42Wide VGA). (Except for *2, *4)
- When the screen mode is FULL, each signal is converted to a 853 dots × 480 lines signal (42Wide VGA). (Except for *3)

Computer input signals supported by this system

Model Signal Type	Dots × lines	Vertical frequency (Hz)	Horizontal frequency (kHz)	Sync Polarity		Presence		Screen mode		RGB select*5	DVI	Memory
				Horizontal	Vertical	Horizontal	Vertical	NORMAL (4:3)	FULL (16:9)			
	640 × 400	70.1	31.5	NEG	NEG	YES	YES	YES*2*3	YES	--	NO	4
IBM PC/AT compatible computers*8	640 × 480	59.9	31.5	NEG	NEG	YES	YES	YES*3	YES	STILL	YES	5
		72.8	37.9	NEG	NEG	YES	YES	YES*3	YES	--	YES	7
		75.0	37.5	NEG	NEG	YES	YES	YES*3	YES	STILL	YES	8
		85.0	43.3	NEG	NEG	YES	YES	YES*3	YES	--	YES	9
		100.4	51.1	NEG	NEG	YES	YES	YES*3	YES	--	YES	41
		120.4	61.3	NEG	NEG	YES	YES	YES*3	YES	--	YES	42
	848 × 480	60.0	31.0	POS	POS	YES	YES	--	YES*3	WIDE2	YES	19
	852 × 480*1	60.0	31.7	NEG	NEG	YES	YES	--	YES*3	WIDE1	YES	17
	800 × 600	56.3	35.2	POS	POS	YES	YES	YES	YES	STILL	YES	11
		60.3	37.9	POS	POS	YES	YES	YES	YES	STILL	YES	12
		72.2	48.1	POS	POS	YES	YES	YES	YES	--	YES	13
		75.0	46.9	POS	POS	YES	YES	YES	YES	--	YES	14
		85.1	53.7	POS	POS	YES	YES	YES	YES	--	YES	15
		99.8	63.0	POS	POS	YES	YES	YES	YES	--	YES	43
	1024 × 768	120.0	75.7	POS	POS	YES	YES	YES	YES	--	YES	44
		60.0	48.4	NEG	NEG	YES	YES	YES	YES	STILL	YES	24
		70.1	56.5	NEG	NEG	YES	YES	YES	YES	--	YES	25
		75.0	60.0	POS	POS	YES	YES	YES	YES	STILL	YES	26
		85.0	68.7	POS	POS	YES	YES	YES	YES	--	YES	27
	1152 × 864	100.6	80.5	NEG	NEG	YES	YES	YES	YES	--	NO	45
		75.0	67.5	POS	POS	YES	YES	YES	YES	STILL	YES	51
	1280 × 768	56.2	45.1	POS	POS	YES	YES	--	YES	WIDE1	NO	52
		59.8	48.0	POS	NEG	YES	YES	--	YES	WIDE3	YES	80
	1360 × 765	60.0	47.7	POS	POS	YES	YES	--	YES	WIDE1	NO	22
	1360 × 768	60.0	47.7	POS	POS	YES	YES	--	YES	WIDE1	YES	22
	1376 × 768	59.9	48.3	NEG	POS	YES	YES	--	YES	WIDE2	YES	53
	1280 × 1024	60.0	64.0	POS	POS	YES	YES	YES*4	YES	STILL	YES	29
		75.0	80.0	POS	POS	YES	YES	YES*4	YES	--	NO	30
85.0		91.1	POS	POS	YES	YES	YES*4	YES	--	NO	40	
100.1		108.5	POS	POS	YES	YES	YES*4	YES	--	NO	47	
1600 × 1200	60.0	75.0	POS	POS	YES	YES	YES	YES	--	NO	54	
	65.0	81.3	POS	POS	YES	YES	YES	YES	--	NO	55	
	70.0	87.5	POS	POS	YES	YES	YES	YES	--	NO	56	
	75.0	93.8	POS	POS	YES	YES	YES	YES	--	NO	57	
	85.0	106.3	POS	POS	YES	YES	YES	YES	--	NO	58	
Apple Macintosh*6, *8	640 × 480	66.7	35.0	Sync on G	Sync on G	--	--	YES*3	YES	--	NO	6
	832 × 624	74.6	49.7	Sync on G	Sync on G	--	--	YES	YES	--	NO	16
	1024 × 768	74.9	60.2	Sync on G	Sync on G	--	--	YES	YES	WIDE1	NO	28
	1152 × 870	75.1	68.7	Sync on G	Sync on G	--	--	YES	YES	WIDE1	NO	39
Work Station (EWS4800)*8	1280 × 1024	60.0	64.6	NEG	NEG	YES	YES	YES*4	YES	--	YES	29
		71.2	75.1	NEG	NEG	YES	YES	YES*4	YES	--	NO	48
Work Station (HP)*8	1280 × 1024	72.0	78.1	--	--	--	--	YES*4	YES	--	NO	59
Work Station (SUN)*8	1152 × 900	66.0	61.8	C Sync	C Sync	--	--	YES	YES	--	NO	60
		76.0	71.7	C Sync	C Sync	--	--	YES	YES	--	NO	61
	1280 × 1024	76.1	81.1	C Sync	C Sync	--	--	YES*4	YES	--	NO	30
Work Station (SGI)	1024 × 768	60.0	49.7	--	--	--	--	YES	YES	--	YES	62
	1280 × 1024	60.0	63.9	--	--	--	--	YES*4	YES	--	YES	29
IDC-3000G												
PAL625P	768 × 576	50.0	31.4	NEG	NEG	YES	YES	YES*7	YES*7	--	NO	31
	NTSC525P	640 × 480	59.9	31.5	NEG	NEG	YES	YES	YES*7	YES*7	MOTION	NO

- *1 Only when using a graphic accelerator board that is capable of displaying 852 × 480.
- *2 Display only 400 lines (42Wide VGA) with the screen center of the vertical orientation located at the center.
- *3 The picture is displayed in the original resolution. The picture will be compressed for other signals.
- *4 Aspect ratio is 5:4. This signal is converted to the following signal (42Wide VGA: 600 dots × 480 lines).
- *5 Normally the RGB select mode suite for the input signals is set automatically. If the picture is not displayed properly, set the RGB mode prepared for the input signals listed in the table above.
- *6 To connect the monitor to Macintosh computer, use the monitor adapter (D-Sub 15-pin) to your computer's video port.
- *7 Other screen modes (ZOOM and STADIUM) are available as well.
- *8 When viewing a moving picture at a vertical frequency greater than 65Hz, the picture may sometimes be unstable (jumpy). If this occurs, please set the refresh rate of the external equipment to 60Hz.
To view 480I@60Hz (480 interlaced lines, 60Hz refresh rate) or 576I@50Hz (567 interlaced lines, 50Hz refresh rate) when sync polarity is "Sync on Green", set "RGB SELECT" to "MOTION".

NOTE:

- *While the input signals comply with the resolution listed in the table above, you may have to adjust the position and size of the picture or the fine picture because of errors in synchronization of your computer.*
 - *This monitor has a resolution of 853 dots × 480 lines. It is recommended that the input signal should be VGA, wide VGA, or equivalent for PD4220V.*
 - *With digital input some signals are not accepted.*
 - *The sync may be disturbed when a nonstandard signal other than the aforementioned is input.*
 - *If you are connecting a composite sync signal, use the HD terminal.*
-
- "IBM PC/AT" and "VGA" are registered trademarks of International Business Machines, Inc. of the United States.
 - "Apple Macintosh" is a registered trademark of Apple Computer, Inc. of the United States.

www.marantz.com

You can find your nearest authorized distributor or dealer on our website.

JAPAN	Marantz Japan, Inc.	35-1 Sagami Ohno 7-Chome, Sagamihara-shi, Kanagawa 228-8505, Japan
U.S.A.	Marantz America, Inc.	1100 Maplewood Drive, Itasca, IL 60143, U.S.A.
EUROPE	Marantz Europe B.V.	P.O. Box 8744, 5605 LS Eindhoven, The Netherlands

marantz® is a registered trademark.

