

42" CLASS (42.0" DIAGONAL)

42LG30DC

37" CLASS (37.0" DIAGONAL)

37LG30DC

32" CLASS (31.5" DIAGONAL)

32LG30DC

26" CLASS (26.0" DIAGONAL)

26LG30DC

22" CLASS (22.0" DIAGONAL)

22LG30DC

LCD Widescreen

Integrated HDTV

NATIVE DISPLAY RESOLUTION
 1366 x 768 (720p HD resolution) - 42"/37"/32"/26"
 1680 x 1050 (720p HD resolution) - 22"

DYNAMIC POWER SAVINGS

DYNAMIC CONTRAST RATIO
 12,000:1 - 42"/37"/32"/26"
 5,000:1 (HDMI™ only) - 22"

BUILT-IN TUNERS
 ATSC/NTSC/Clear QAM

PUBLIC DISPLAY SETTINGS
 Cloning capable

USB CLONING
 42"/37"/32"

LG'S EXCLUSIVE XD ENGINE™

EYE CARE™
 Reduces brightness on extremely bright images
 42"/37"/32"/26"

2 HDMI WITH HDCP
 V.1.3 with deep color 42"/37"/32"/26"

AUTO-SENSING REMOTE JACK PACK (RJP) COMPATIBLE
 42"/37"/32"

PRO:IDIOM® CAPABLE
 using optional HCS5610 pay-per-view box

ENERGY STAR® COMPLIANT

RoHS COMPLIANT

INVISIBLE SPEAKER SYSTEM

CABINET COLOR
 High-gloss black

1-YEAR LIMITED WARRANTY
 (parts/labor)



XD ENGINE

SHARPER
BRIGHTER
CLEARER

ULTRA CONTRAST

AT A BLAZINGLY FAST 370 MILLION PIXELS PER SECOND, THE PROCESSOR USES A HISTOGRAM ANALYSIS TOOL TO CLARIFY THE IMAGE DATA ACCORDING TO SIGNAL BRIGHTNESS LEVELS.

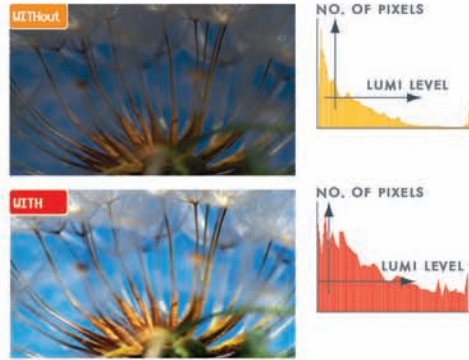

Dramatization

DYNAMIC BLACK STRETCH

THE MINIMUM BLACK LEVEL OF AN IMAGE IS AUTOMATICALLY DETECTED AND ADJUSTED ACCORDING TO BRIGHTNESS.

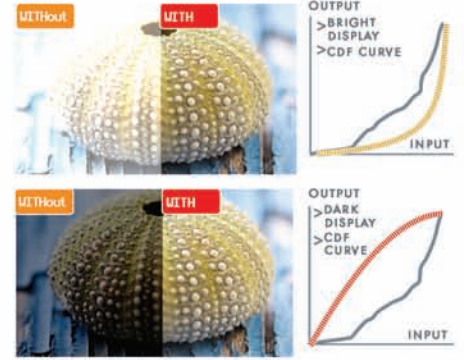

Dramatization

SPECIAL FEATURES

CLEAR VOICE

BALANCED SOUND TO EMPHASIZE DIALOGUE

Designed to automatically enhance and amplify the sounds of the human voice frequency range, Clear Voice Technology preserves high-quality dialogue audio when background noises swell. You won't miss a word of the action.



invisible SPEAKER

SOUND IS HEARD, NOT SEEN

Breaking through the fixed idea that speaker grills must be exposed, the Invisible Speaker design provides a "full sweet spot" and realistic sound equal to that of theaters. Personally tuned by Mr. Mark Levinson, world-renowned audio authority, this unique design has rich and lively sound that can be enjoyed from any angle.



PUBLIC DISPLAY SETTINGS CLONING CAPABLE

When used in public areas, these HDTVs can be easily programmed by the installer to have the TV turn on at a specified channel/volume level, set the minimum/maximum volume, lock out the control panel/remote, set the aspect ratio, and return to a factory reset. By using Power Management, these displays can be programmed to turn off if there has been no activity (remote or control panel buttons) for a preset time (1-7) hours.

Public Display Settings	
Public Display Mode	No
Start Channel	No
Ch. Type	TV
Major	2
Minor	0
Minimum Volume	0
Maximum Volume	100
Start Volume	No
Level	20
Power Management	No
Setting	1
Key Management	0
Factory Reset	0
Aspect Ratio	0
PDM Plus	▶

CLEAR SCREEN

USING THE NOISE FILTER INSIDE THE XD ENGINE CHIP, THE IMAGE IS ANALYZED FOR TEMPORAL AND SPATIAL INFORMATION TO REDUCE MPEG NOISE.

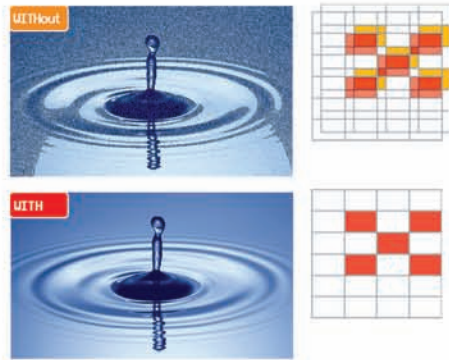

Dramatization

ADVANCED VIVID COLOR

COLORS THAT ARE SENSITIVE TO THE HUMAN EYE ARE OPTIMIZED TO THE NEAREST TRUE COLOR BY THE SELECTIVE COLOR CONTROL.

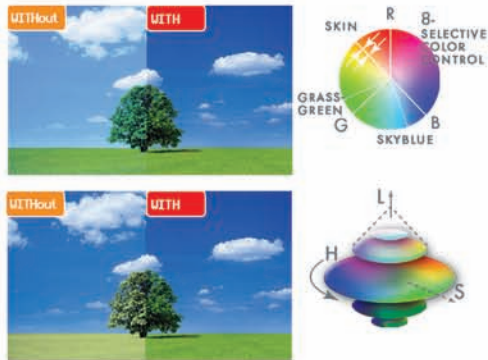

Dramatization

INTELLIGENT EDGE CONTROL

EDGE LINES ARE EMPHASIZED BY IMPROVING THE TRANSITION FROM THE BACKGROUND TO THE MAIN OBJECT.

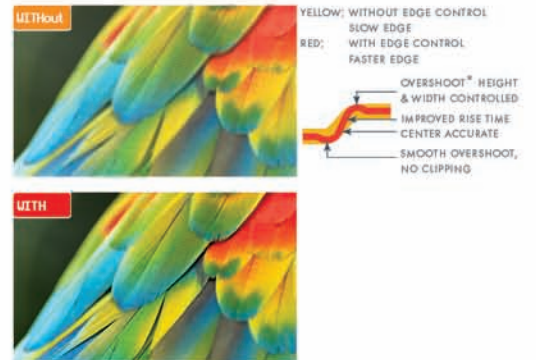

Dramatization

USB CLONING

42" / 37" / 32"

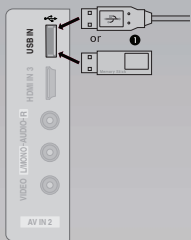

SCREEN SHOT OF
USB CLONING
LEARNING & TEACHING

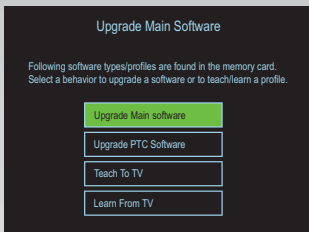

OPTIONAL CLONING PROGRAMMER
LT2002 REMOTE
QUICKSET II "CLONE" (26"/22")



The LT2002 allows for custom setup and programming information to be quickly copied from a "master" LG or Zenith brand LCD, Plasma, or CRT TV (with the MPI™ input) into an unlimited number of identical models. This saves the installers hours of time duplicating the hotel TV settings, such as minimum volume, maximum volume, start up channel, channel mapping, etc.

DIMENSIONS

42LG30DC
37LG30DC
32LG30DC

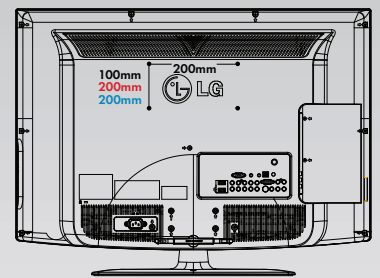
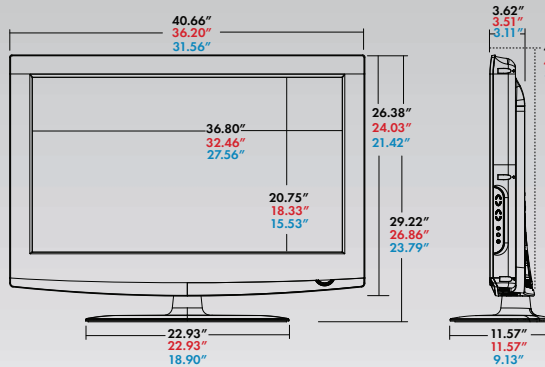

26LG30DC
22LG30DC

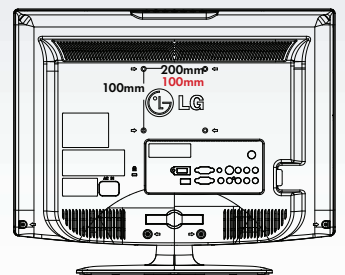
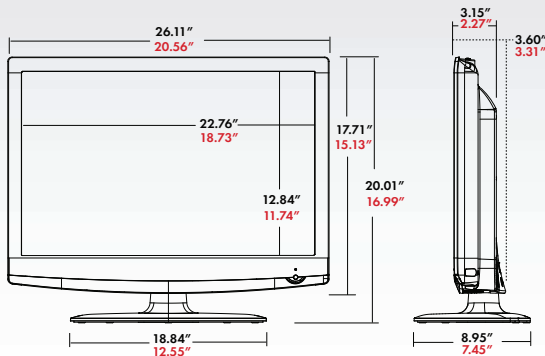

JACK PACKS

REAR 42", 37", 32"

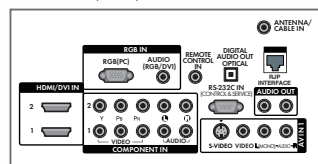

SIDE



REAR 22"

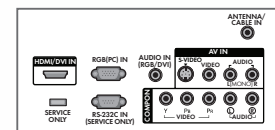

SIDE



REAR 26"

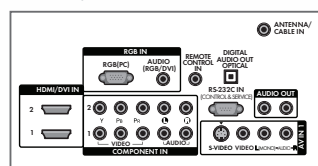

SIDE



42LG30DC
37LG30DC
32LG30DC
26LG30DC
22LG30DC

SPECIFICATIONS

42" CLASS (42.0" DIAGONAL)	42" (42LG30DC)
37" CLASS (37.0" DIAGONAL)	37" (37LG30DC)
32" CLASS (31.5" DIAGONAL)	32" (32LG30DC)
26" CLASS (26.0" DIAGONAL)	26" (26LG30DC)
22" CLASS (22.0" DIAGONAL)	22" (22LG30DC)
PANEL	
LCD Panel Type	42" (42LG30DC) 37" (37LG30DC) 32" (32LG30DC) 26" (26LG30DC) 22" (22LG30DC)
Display Area	42.0" diagonal (42LG30DC) 37.0" diagonal (37LG30DC) 31.5" diagonal (32LG30DC) 26.0" diagonal (26LG30DC) 22.0" diagonal (22LG30DC)
Native Display Resolution	1366 x 768 (42", 37", 32", 26") 1680 x 1050 (22")
Brightness	500 cd/m ² (42", 37", 32") 400 cd/m ² (26") 250 cd/m ² (22")
Dynamic Contrast Ratio	12,000:1 (42", 37", 32", 26") 5,000:1 (HDMI only) (22")
Contrast Ratio	1,000:1 (42", 37", 32") 700:1 (26") 600:1 (22")
Viewing Angle (HxV)	178° x 178° (42", 37", 32", 26") 160° x 160° (22")
Response Time (G to G)	5ms
Pure Black Level	Yes
True Wide View	Yes
Life Span (approx. hr)	60,000 (Module 50,000)
BROADCASTING SYSTEM	
Analog/Digital	ATSC/NTSC/Clear QAM 1 tuner
VIDEO	
XD Engine	Yes
Eye Care™	Yes (42", 37", 32", 26")
Aspect Ratio	16:9
Aspect Ratio Correction	6 mode (16:9, Just scan, 4:3, Set by program, Zoom1, Zoom2)
Just Scan (0% overscan)-when "Just Scan Mode" selected	HDMI (1080i/1080p/720p) Component (1080i/1080p/720p) RF(1080i/720p)
Enhanced Line Doubler	Yes
Enhanced Noise Reduction	Yes (3D & MPEG)
Digital Comb Filter	Yes (3D)
DLTI (Digital Luminance Transient Improver)	Yes
Color Temperature Control	Cool, Medium, Warm, User
Black Stretcher	Yes
Cinema 3:2, 2:2 Pulldown	3:2 (TV/S-Video/Composite - 480i, Component 480i/576i/1080i)
Picture Status Mode	7 mode (42", 37", 32", 26") 5 mode (22")
XD color (Active Color Management)	Yes
DTV Signal Strength (Digital)	Yes
AUDIO	
Mono/Stereo/Dual (MTS/SAP)	Yes
Audio Output (Watts - THD 10%)	10W + 10W (42", 37", 32", 26") 3W + 3W (22")
Speaker System	High Tech Speaker (Invisible Speaker) 2 Way 4 Speakers (42", 37", 32", 26") 1 Way 2 Speakers (22")
Dolby Digital® Decoder	Yes
Surround System	SRS TruSurround XT™ (42", 37", 32", 26")
Bass/Treble/Balance	Yes
AVL (Auto Volume Leveler)	Yes
Sound Status Mode	5 modes (Standard, Music, Cinema, Sports, Game)
CC When Mute	Yes (42", 37", 32", 26")
SPECIAL FEATURES	
Public Display Settings	Yes
EPG (Brief Info)	Yes
USB Cloning	Yes (42", 37", 32")
T080p Source Input	HDMI (60/30/24p)/Component (60/30/24p) RGB (60p)
AV Input Navigation	Yes
Auto Navigation	Yes

Input Labeling	Cable Box/VCR/DVD/Set Top Box/PC/Game (except 22")
Quick View (Flash Back)	Yes
Clear Voice (On/Off)	Yes
Quick Set-up Guide	Yes
Parental Control w/ V-Chip	Yes
Key Lock	Yes
Kensington Lock Slot	Yes (22" only)
Closed Caption	Yes
SimpleLink (HDMI CEC)	Yes (except 22")
Auto/Manual Clock	Yes
On/Off Time, Sleep, Auto off	Yes
EZ OSD (Menu System)	Yes
Language	3 (English, Spanish, French)

COMPATIBILITIES	
Pro:Idiom	Yes (using HCS 5610 pay-per-view box)
Optional Auto-Sensing Remote Jack Packs	Yes 42", 37", 32" (26", 22" with HCS 5610 box)

JACK PACK	
Side	AV In 1 (42", 37", 32", 26") HDMI In 1-V.1.3 (26" only) USB 2.0 (Cloning and Service) 1 (42", 37", 32", 26") Headphone In 1 (22" only)
Rear	RF In (Antenna/Cable) 1 AV In 1 S-Video In 1 Component in (Y,Pb,Pr) + Audio 2 (42", 37", 32", 26"), 1 (22") Digital Audio Out (Optical) 1 (42", 37", 32", 26") Analog Audio Out (L/R) 1 (42", 37", 32", 26") HDMI/HDCP Input 2 -V.1.3 (42", 37", 32", 26"), 1-V.1.2 (22") RGB In (D-sub 15pin) - PC 1 PC Audio Input 1 RJ45 (for R/P interface) 1 (42", 37", 32") S-232C (Control / SVC) 1 Remote Control In port 1 USB (Service Only) 1 (26" only)

CABINET	
Unit Dimensions with Stand (WxHxD)	40.66" x 29.22" x 11.57" (42") 36.20" x 26.86" x 11.57" (37") 31.56" x 23.79" x 9.13" (32") 26.11" x 20.01" x 8.95" (26") 20.56" x 16.99" x 7.45" (22")
Unit Dimensions without Stand (WxHxD)	40.66" x 26.38" x 3.62" (4.53")* (42") 36.20" x 24.03" x 3.51" (4.50")* (37") 31.56" x 21.42" x 3.11" (3.98")* (32") 26.11" x 17.71" x 3.15" (3.60")* (26") 20.56" x 15.13" x 2.72" (3.31")* (22")

Unit Weight	with Stand 52.0 lbs (42") 41.4 lbs (37") 29.4 lbs (32") 22.3 lbs (26") 12.3 lbs (22")	without Stand 46.3 lbs (42") 35.7 lbs (37") 26.1 lbs (32") 19.0 lbs (26") 11.8 lbs (22")
-------------	------------------------------------------------------------------------------------------------------	---------------------------------------------------------------------------------------------------------

Carton Dimensions (WxHxD)	52.4" x 30.4" x 10.1" (42") 47.05" x 26.18" x 9.96" (37") 38.4" x 26.2" x 7.6" (32") 32.6" x 21.2" x 8.3" (26") 23.3" x 18.5" x 6.8" (22")
---------------------------	--------------------------------------------------------------------------------------------------------------------------------------------------------

Shipping Weight	63.1 lbs (42") 50.7 lbs (37") 35.9 lbs (32") 27.6 lbs (26") 5.2 lbs (22")
-----------------	---------------------------------------------------------------------------------------

Invisible Speaker System	Yes
Stand able to mount to desk	Yes (22" only)
Cabinet Color	High-Gloss Black
Cable Management Clip	Yes
Swivel (stand)	Included/Detachable +/- 20° (42", 37", 32", 26")
ENERGY STAR Compliant	Yes
RoHS Compliant	Yes
UL Standard	Listed
VESA™ Compatible	Yes (200mm x 200mm, M6) (42", 37") Yes (200mm x 100mm, M4) (32", 26") Yes (100mm x 100mm, M4) (22")

POWER	
Dynamic Power Savings**	Yes (42" -79%, 37" -76%, 32" -69%)
Voltage, Hz	100 ~ 240V, 50/60Hz
Power Consumption (Max/Typical)	244W/226W (42"), 191W/167W (37"), 171W/149W (32"), 115W/99W (27"), 48W/46W (22")
Power Consumption (Stand-by)	Under 1W

UPC	
42LG30DC	7 19192 17411 5
37LG30DC	7 19192 17410 8
32LG30DC	7 19192 17409 2
26LG30DC	7 19192 17408 5
22LG30DC	7 19192 17407 8
LIMITED WARRANTY	
	1 Year (parts/labor)

* Depth of monitor including stand adapter plate.
** When Dynamic Power Savings is enabled these power savings could be attained.



All screen images are simulated. Dimensions and weights are approximate. Design, features and specifications subject to change without notice.

© Copyright 2008 LG Electronics USA, Inc. All Rights Reserved. "LG Life's Good" is a registered trademark of LG Corp. Eye Care is a trademark of LG Corp. XD Engine is a registered trademark of LG Electronics USA, Inc. Pro:Idiom is a registered trademark of Zenith Electronics Corp. MPI is a trademark of Zenith Electronics Corp.

ENERGY STAR is a registered trademark of the U.S. Environmental Protection Agency. VESA is a trademark of Video Electronics Standards Association. All other product and brand names are trademarks or registered trademarks of their respective companies.

Printed in the USA. August 2008

www.LGcommercial.com



LG Electronics U.S.A., Inc.
Commercial Products Division
2000 Mills Drive,
Lincolnshire, IL 60069

Customer Service: 888-865.3026

Contact your LG Regional Sales Representative:
Hospitality: 800.228.1236
B2B: 800.897.8788
Channel Markets: 800.897.8871

SPEC_42-22LG30DC LG050806_PR