

# JVC

## WIDE LCD PANEL TV INSTRUCTIONS



**LT - 32EX18**  
**LT - 42EX18**

**HDMI™**  
HIGH-DEFINITION MULTIMEDIA INTERFACE

ENGLISH

### Contents

#### PREPARATION

Safety precautions.....	2
Remote control buttons and functions...	3
Set up and connections .....	4
Initial settings.....	6
Registering / Editing channels .....	6

#### FUNCTIONS

Picture setting.....	7
Sound setting .....	9
Useful functions.....	10
Viewing Teletext.....	12
Watching Video or DVDs.....	12

#### REFERENCE

Troubleshooting.....	13
Technical information.....	14
CH/CC List.....	15
Specification .....	16

GGT0211-001A-H

Thank you for buying this JVC LCD panel television.

To make sure you understand how to use your new TV, please read this manual thoroughly before you begin.

• **Follow this manual regarding setup!**

- Connect only to a 110-240 V, 50/60Hz AC outlet.

• **Make enough room for inserting and removing the power plug!**

• **Place the TV as close to the outlet as possible!**

- The main power supply for this TV is controlled by inserting or removing the power plug.

• **Never cut or damage the power cord!**

- If the AC plug is not the right shape, or the power cord is not long enough, use an appropriate plug adapter or extension cable. (Consult your retailer.)

• **Unplug the power cord when going out!**

- The power buttons on the remote control and the TV unit cannot completely turn off the TV. (Make appropriate arrangements for bedridden people.)

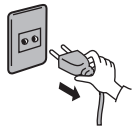

• **Do not allow the TV to fall!**

- Do not rest your elbows on, or allow children to hang from the TV.
- There is a risk that the TV will fall and cause injuries.

If the TV is damaged or behaving strangely, stop using it at once!

➔ Unplug the power cord and contact your retailer.

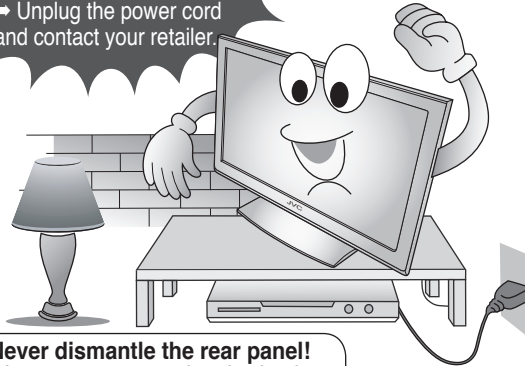

• **Never dismantle the rear panel!**

- It may cause an electric shock.

• **Never obstruct the ventilation holes!**

- It may cause overheating or a fire.

• **Handle LCD panel with care!**

- Use a soft, dry cloth when cleaning.

• **Never place anything on the TV!**

- Placing liquid, naked flames, cloths, paper, etc. on the TV may cause a fire.

• **Never expose to rain or moisture!**

- To prevent fire or electric shock, never allow liquids to enter the unit.

• **Never insert objects into the cabinet openings!**

- It may cause a fatal electric shock.  
- Take care when children are near.

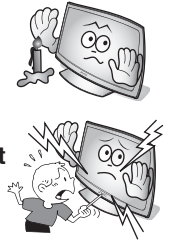

• **Hold the TV so as not to scratch the screen!**

- Do not touch the screen when carrying the TV.

• **Do not carry the TV on your own!**

- In order to prevent accidents, ensure that the TV is carried by two or more people.

• **When attaching the TV to the wall, use the optional JVC wall mounting unit!**

- Consult a qualified technician.

- See the included manual on mounting procedures.

- JVC assumes no responsibility for damage due to improper mounting.

• **Never listen to headphones at high volume!**

- It may damage your hearing.

**Never try repair the TV yourself!**

➔ If the problem cannot be solved in "Troubleshooting" (P.13), unplug the power cord and contact your retailer.

• For more details on installation, usage and safety ➔ Consult your retailer.

# Remote control buttons and functions

- Insert the batteries  
Use two “AAA/R03” dry cell batteries. Insert the batteries from the ⊖ end, making sure the ⊖ and ⊕ polarities are correct.

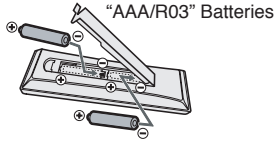

Turn the volume off/on  
Change channel/page

## RETURN PLUS function

Return to the frequently viewed channel.

### Choose the channel you want to programme



Press and hold

Return Plus  
Programmed!

### To cancel



Press and hold

Return Plus  
Canceled!

## RETURN function

If you have not set or have canceled the RETURN PLUS channel, this will return to the previously viewed channel.

Select TV or Video input  
Channel information

## Channel selection

Select the desired channel number.

### For Hyper Scan



Press and hold

PR changes without changing the picture. Once you stop pressing CHANNEL+ or CHANNEL- button, picture will change to the desired PR.

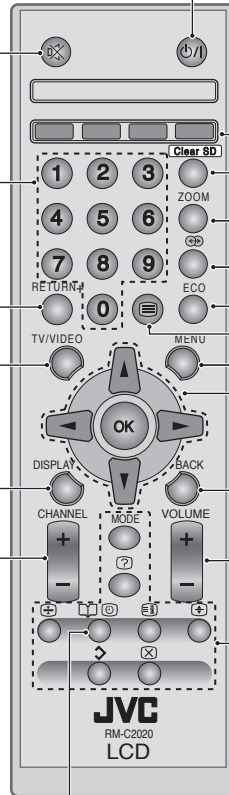

Turn the TV on from standby

Colour button

Turn on “Clear SD”

Change the aspect ratio (P. 8)

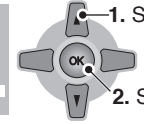
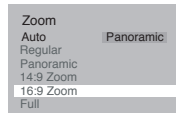

V-Scroll

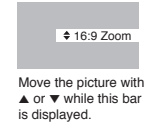

Move the picture with ▲ or ▼ while this bar is displayed.

Turn on “Cinema Surround”

Turn on “Eco Mode”

To Teletext (P. 12)

Display on-screen menu

Operate the menu

To previous screen

Adjust the volume, Turn off muting

View the Teletext (P. 12)

Favourite channel setting. (P. 11)

1. Register the favourite channel



Press and hold

Programmed!



Press number button (1-4 only)

2. Recall the favourite channel



Press



Press number button (1-4 only)

- If the favourite channel has not been registered then “No Memory” will be displayed.

## Set up and connections



### Power lamp

ON : Lit (Blue)  
OFF : Unlit

Power lamp lights while the TV is on.  
• "Power Lamp" (P. 11)

Remote control sensor ←

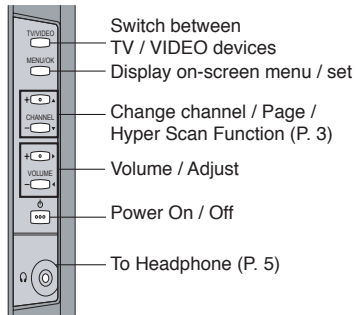

## Care when setting

### Power requirements

- Connect the power cord only to a 110-240V, 50/60Hz AC outlet.

### When attaching the TV to the wall, use the optional JVC wall mounting unit

- Consult a qualified technician.
- JVC assumes no responsibility for damage due to improper mounting.
- 200mm x 200mm mount which conforms to VESA standards.

### Installation requirements

- To avoid overheating, ensure the unit has ample room.

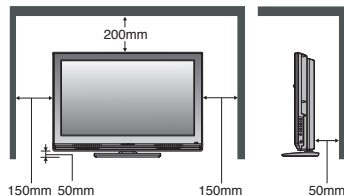

## Connect an aerial and VCR / DVD Player

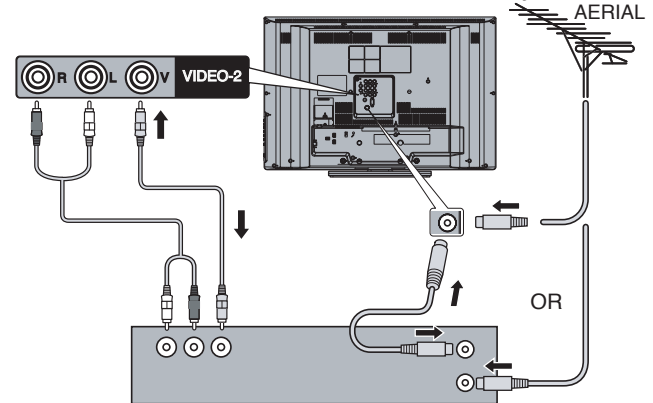

VCR (DVD Player)

- After all the connections have been made, insert the plug into an AC outlet.

## Stand Assembly

- Insert the stand into the panel at the position where the screw holes are, and fasten the screws.

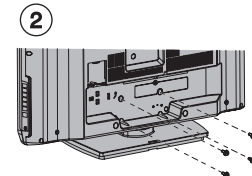
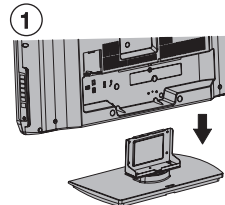

- If you have any problem with assembly, please contact a retailer or a dealership.

Note: 4 screws included.

## Set up and connections (continued)

You can connect many different devices to the rear panel of the TV.  
Please read the user manuals of each device before setup.  
(Connecting cables are not supplied with this TV.)

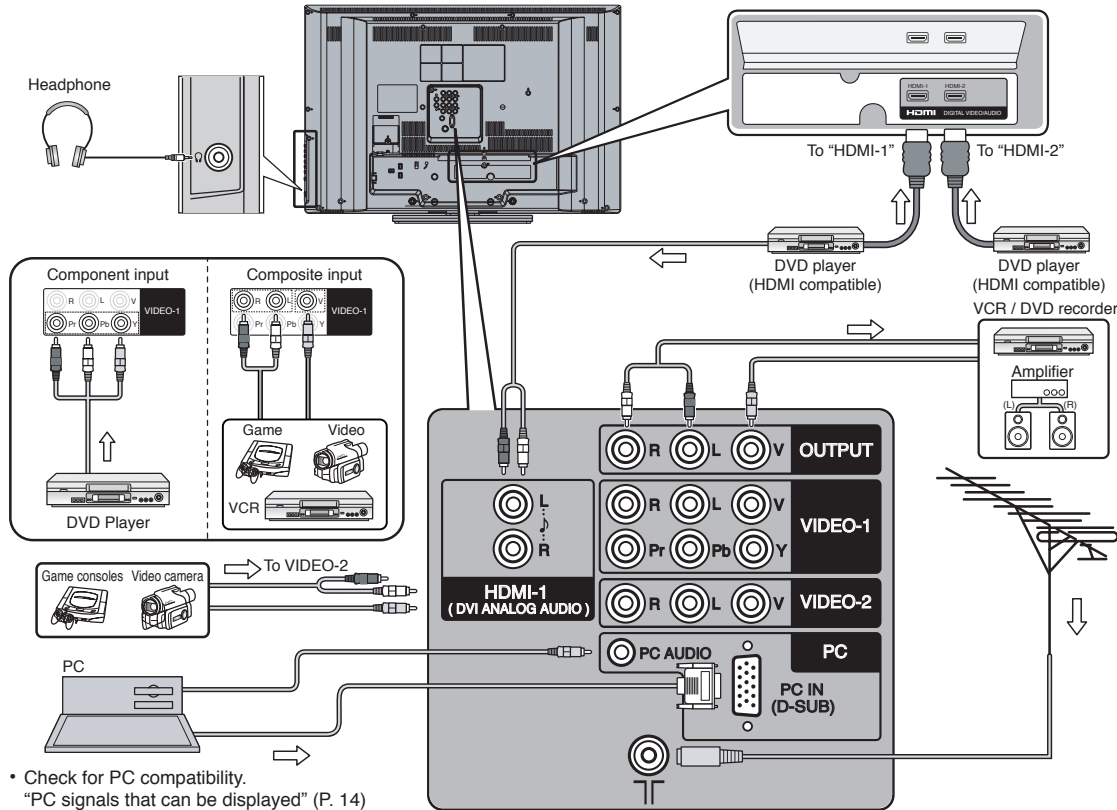

- Check for PC compatibility.  
"PC signals that can be displayed" (P. 14)

### VIDEO-1 Watching videos

Output	Input
	<ul style="list-style-type: none"> <li>• Composite signal / Component signal (P. 16)</li> <li>• Sound L / R</li> </ul>

- Use Component signal  
"Video - 1 setting" (P. 12)

### VIDEO-2 Watching videos

Output	Input
	<ul style="list-style-type: none"> <li>• Composite signal</li> <li>• Sound L / R</li> </ul>

### HDMI-1 Connecting HDMI-2 HDMI devices

Output	Input
	<ul style="list-style-type: none"> <li>• HDMI signal (P. 16)</li> </ul>

- "HDMI setting" (P. 12)
- HDMI-2 input does not support analogue audio.
- Connect a "DVI" device to "HDMI-1" (P. 14)

### OUT

- Video and sound signal of a TV channel you are viewing outputs from this terminal.

Output
<ul style="list-style-type: none"> <li>• Composite Signal</li> <li>• Sound L/R</li> </ul>

## Initial Settings

### 1 Turn on the TV



- Show only when powering on for the first time.
- The power on the unit can also be used.

### 2 Select a language

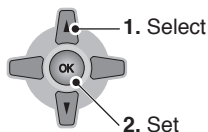
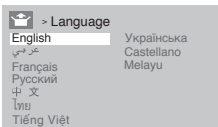

### 3 Select the teletext language group

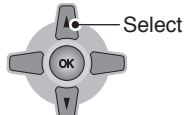

- See “Language group for teletext” (P. 14)

### 4 Automatically register channels (Auto Program)

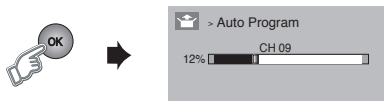

### 5 Check what was registered

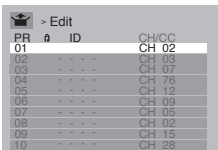

- If you want to edit channel, read the next column.

## Registering / Editing channels

You can edit the channel list or register new channel manually.

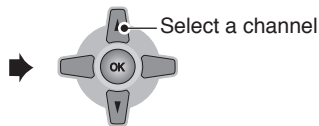
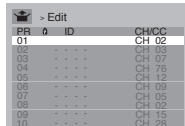

### Move Move a channel position

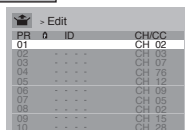

### ID Edit a channel name

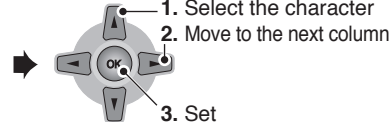
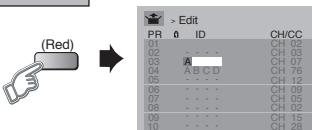

### Insert/Delete Insert / Delete a channel

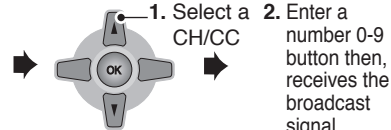
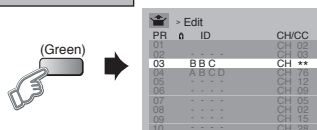

- Delete a channel by press (Yellow) button.
- “CH/CC List” (P. 15)

### Manual Register a new channel

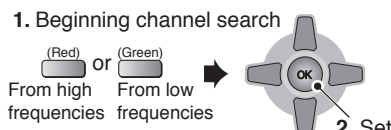
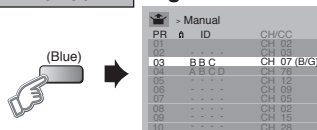

- Channel fine tuning => (Yellow) / (Blue)
- If the picture or sound is unnatural => [TV] for select a system.

# Picture setting

## 1. Display "Picture" menu

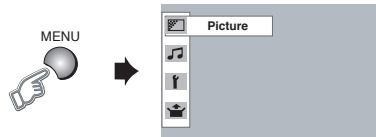

## 2. Select item and setting or adjust

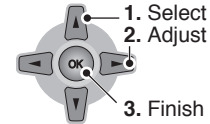
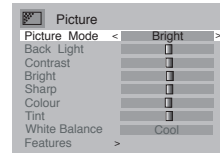
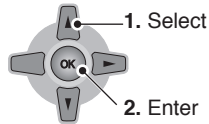

• To enter an items menu

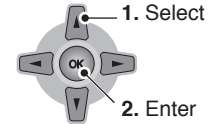

Picture Mode	<p>You can select a preset picture setting according to you favour.</p> <ul style="list-style-type: none"> <li>→ Bright : Hightens contrast and sharpness.</li> <li>↓ Standard : Standardize picture adjustment.</li> <li>↓ Soft : Softens contrast and sharpness.</li> </ul>
Back Light	<p>You can change the backlight brightness.</p> <p>Darker ↔ Brighter</p>
Contrast	<p>You can change the contrast of the picture.</p> <p>Lower ↔ Higher</p>
Bright	<p>You can change the brightness of the picture.</p> <p>Darker ↔ Brighter</p>
Sharp	<p>You can change the sharpness of the picture.</p> <p>Softer ↔ Sharper</p>
Colour	<p>You can change the colour of the picture.</p> <p>Lighter ↔ Deeper</p>
Tint	<p>You can change tint only in NTSC.</p> <p>Reddish ↔ Greenish</p>
White Balance	<p>You can change the white balance of the picture to better match the type of video being view.</p> <ul style="list-style-type: none"> <li>→ Cool : Bluish white colour.</li> <li>↓ Warm : Reddish white colour.</li> <li>↓ Mid : Normal white colour.</li> </ul>

## Picture setting (continued)

### Features

#### Finer Picture adjustment

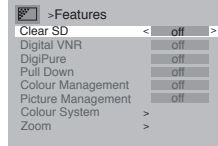

#### Clear SD

: For clearly picture (Off / Mode-1 / Mode-2)  
When Clear SD set to Mode-1 or Mode-2, then Digital VNR and DigiPure and Picture Management cannot operate.

#### Digital VNR

: Reduce the amount of noise in original picture. (Off / On)

#### DigiPure

: For natural - looking outlines (Off / On)

#### Pull Down

: For smooth cinema film (Auto / Off / On)

#### Colour Management

: For natural - looking pictures (Off / On)

#### Picture Management

: Fix bright / dark pictures. (Off / On)

#### Colour system

: When there is no colour, change the colour system. (PAL / SECAM / NTSC 3.58 / NTSC 4.43 / AUTO)

#### Zoom

: Change the aspect ratio.

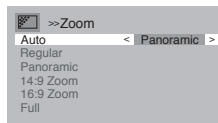

#### Panoramic

16 : 9

#### Regular/Slim

4 : 3

#### 14:9 Zoom

14 : 9

- When 720p or 1080i or 1080p signal is received, "Full" and "Slim" can be selected.
- In PC mode, "Regular" and "Full" can be selected.



# Sound setting

1. Display "Sound" menu.

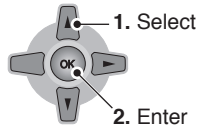
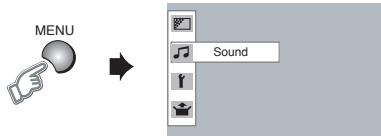

2. Select item and setting or adjust.

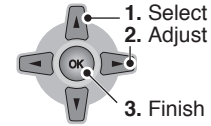
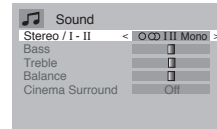

<b>Stereo / I-II</b>	Select the stereo, mono or bilingual language (O : Mono /  : Stereo / I : SUB1 / II : SUB2 / Mono)
<b>Bass</b>	Low tones (Weaker ↔ Stronge)
<b>Treble</b>	High tones (Weaker ↔ Stronge)
<b>Balance</b>	Speaker balance (Left Stronger ↔ Right Stronger)
<b>Cinema Surround</b>	Ambient sound 

• Prevent the sudden change of sound.

**AI Volume**

Prevent sudden increase or decrease of sound when changing channels.

1. Display "Set Up" menu.

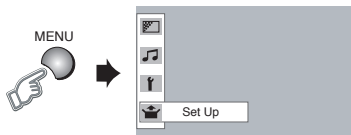

2. Select "AI Volume"

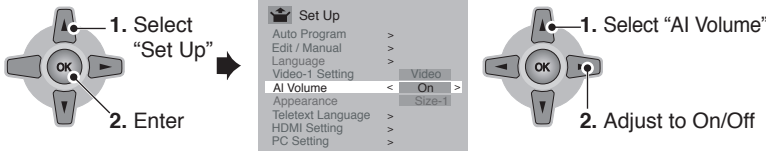

# Useful functions

1. Display "Features" menu.

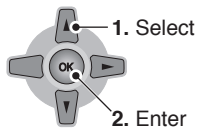
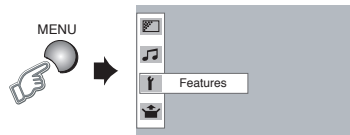

2. Select item and setting or adjust.

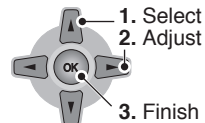
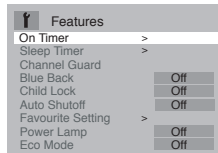

• To enter an items menu

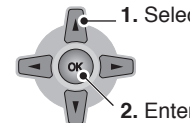

## On Timer

TV to turn on automatically from standby mode at a set channel and time.

1. Select PR channel that you want to watch.

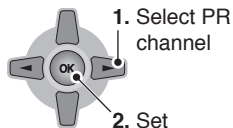
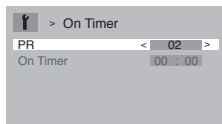

2. Set the On time to your desired period at time.

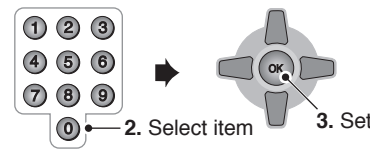
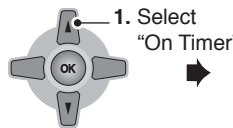

Note : Press (Blue) for reset time setting.

## Sleep Timer

TV to turn off automatically to standby mode after a set time.

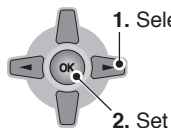
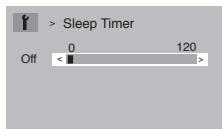

Note : When the remaining elapse is one minute, "Good Night!" appears on the screen.

## Channel Guard

Stop children from watching specific channels.

1. Select "Channel Guard"

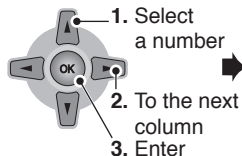

2. Select a channel and lock it ( : locked )

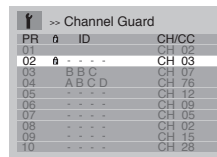

• View a locked channel by use the numerical buttons to enter the channel number. When appears, press "DISPLAY" button and enter your "ID No."

## Useful functions (continued)



Blue Back	Display a blue screen and mute the sound when the signal is weak or absent. (On / Off)
Child Lock	Disables the side control buttons of the TV. (On / Off)
Auto Shutoff	Set the power to turn off if no signal is received and no operation is performed for about 15 minute. (On / Off)
Favourite Setting	<p>Delete the favourite channel that you registered.</p> 
Power Lamp	Power lamp lights while the TV is on. (On / Off) (P. 4)
Eco Mode	Adjust contrast of light and dark according to the brightness of your room. (Off / Eco-1 / Eco-2)

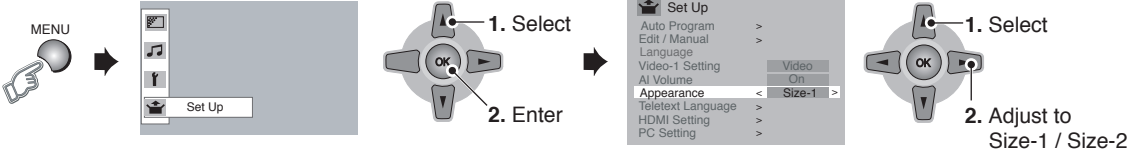







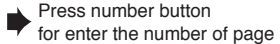

### • Change the on screen menu size.

Appearance	<p>Change the on-screen menu size.</p> <p>1. Display "Set Up" menu.</p>  <p>2. Select "Appearance"</p>
------------	---

## Viewing Teletext

You can watch the Teletext broadcast channel with Text Functions.

- 
 TV mode <--> TEXT mode
- Select a teletext page by press number button (0-9)
  - Move up or down a page by
 

List Mode	<p>Bookmark your favourite page.</p>   to bookmark  Press number button for enter the number of page  Save • Recall your favourite page by press the colour button.
Hold	 Hold the current page. <ul style="list-style-type: none"> <li>• Cancel by press this button again.</li> </ul>
Reveal	 Display hidden information. <ul style="list-style-type: none"> <li>• Example : answer to a quiz, etc.</li> </ul>
Size	 Double the size of the displayed text.
Index	 Returns to page "100" or a previously designated page.
Cancel	 Leave the current page open, while you switch to watch TV. <ul style="list-style-type: none"> <li>• Useful when running a page search.</li> </ul>
Sub-page	 Display the number of Sub-page. <ul style="list-style-type: none"> <li>• Cancel by press this button again.</li> </ul>

## Watching Video or DVDs

Select the input Source.





- Select
- Set

Note: TV/VIDEO button select the video source by move down or use button 0-5 for selection.

• Operate the connected device and play video.

1. Select "Set Up"





- Select
- Enter

2. Select item

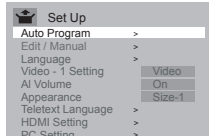
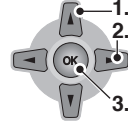



- Select item
- Setting or Adjust
- set

Video - 1 Setting

Switch between video and component signal (Video / Component)  
Setting for HDMI input

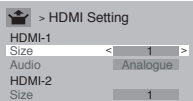
HDMI setting



**Size** : Normally set to "Auto." If wrong screen size appears in 480p (525p), change to "1" or "2"  
**Audio**: Normally set to "Auto." If no sound, change to "Analogue" or "Digital."  
• "Audio" is not available for HDMI - 2

PC Setting

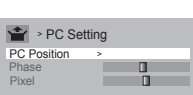

Setting for PC input

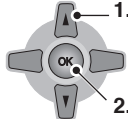
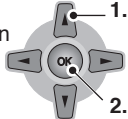



- Select PC Position
- Adjust
- Enter
- Set

**PC Position** : Adjust screen position.  
**Phase** : Sets the focus of screen.  
**Pixel** : Adjusts the horizontal feature of screen.

# Troubleshooting

If a problem occurs when you are using the TV, check the below troubleshooting guide before calling for repair.

Severe noise or snow	Page
Check the aerial cable and TV connections .	P. 4
Check the direction of the aerial.	P. 4
Check the aerial or its cable damaged or not.	--
Patterns, stripes or noise	
Interference caused by devices such as an amplifier, personal computer, or a hair drier, Move it away from TV.	--
Ghosting ( Doubling of images )	
Interference occurs caused by signal reflection from mountains or building. Try to adjust the aerial's direction or use another antenna.	--
Cannot turn it on	
Ensure the power cord is connected to the AC outlet correctly.	--
Connot operate the remote control.	
The batteries may be exhausted. Replace with new batteries. Ensure that you are operation the remote control at less than 7 meters from the front of your TV.	--
Remote control stops working	
Unplug TV, several minutes later plug it in again.	--
Side control buttons do not work	
Switch "Child Lock" to "Off".	P. 11
Aspect ratio changed unintentionally	
Press  button to return to your settings.	P. 8
PC screen alignment is off	
Adjust the "PC Position" in "PC Setting" of Set Up menu.	P. 12
Blue screen appears on the screen	
Switch "Blue Back" to "Off".	P. 11
Strange picture when using an external device	
If the top of the image is distorted, check the video signal quality itself.	--
If movement appears unnatural when receiving a signal from a DVD player, etc. with 625p (progressive-scanning), change the output setting of the external device to 625i (interlace-scanning)	--

Poor picture quality	Page
Unnatural colour >> Adjust "Colour" and "Back Light"	P. 7
Check "Colour System". If "Auto" is selected select the specific colour system manually.	P. 8
Noise >> Set to the following functions.	
Picture Mode : Standard	P. 7
DigiPure : On	P. 8
Dull picture >> Set to the following functions.	
Picture Mode : Bright	P. 7
DigiPure : On	P. 8
Poor sound	
Adjust the "Bass" and "Treble".	P. 9
If receiving a poor signal in "Stereo/ 1 " switch to "Mono".	P. 9
Adjust the channel reception using "Manual".	P. 6
For HDMI signal, wrong screen size in 480p (525p).	
Switch "Size" in "HDMI setting" to "1" or "2".	P. 12
For HDMI signal, green and distorted screen	
Wait a little for the signal to stabilize when switching the signal format for an "HDMI" device.	--
For HDMI signal, No picture / No sound	
Use the cable marked with HDMI logo.	--
Check if the device is compliant with HDMI.	P. 12
Switch "Audio" in "HDMI Setting" to "Digital" or "Auto" for HDMI devices, or "Analogue" or "Auto" for DVI devices.	
Some functions do not work.	
It is not a malfunction. Some functions (dark background) in the menu do not work depending on the situation.	--
Black or white dots appear on the screen.	
LCD panels use fine dots ("pixels") to display images. While more than 99.99% of these pixels function properly, a very small number of pixels may not light, or may light all the time. It is not a malfunction.	--
No picture, No sound	
Some input do not output from OUT terminal.	--

## Technical information

### Language group for teletext

Group	Languages
Group-1	Turkish, Hungarian, English, German, French, Italian, Spanish, Portuguese, Greek, Swedish, Finnish
Group-2	Polish, Serbian, Croatian, Slovenian, Czech, Slovak, Rumanian, Hungarian, German, French, Italian, Swedish, Finnish
Group-3	Russian, Bulgarian, Lettish, Lithuanian, Estonian, Ukrainian, Serbian, Croatian, Slovenian, Czech, Slovak, English, German
Group-4	Arabic, Czech, Slovak, Hungarian, English, German, French, Italian, Spanish, Portuguese, Swedish, Finnish
Group-5	Farsi, Czech, Slovak, Hungarian, English, German, French, Italian, Spanish, Portuguese, Swedish, Finnish
Group-6	Lettish, Lithuanian, Estonian, Ukrainian, Czech, Slovak, English, German

- If the characters are unreadable. ➔ Select different teletext language group. (P. 6)

### Sound and Colour system in your country or region

Area	Country or Region	System	System
Asia, Middle East	Bahrain, Kuwait, Oman, Qatar, United Arab Emirates, Yemen, Indonesia, Malaysia, Singapore, Thailand, India, etc.	B/G	PAL
	China, Vietnam, etc.	D/K	
	Hong Kong, etc.	I	
	Islamic Republic of Iran, Lebanon, Saudi Arabia, etc.	B/G	SECAM
	Philippines, Taiwan, Myanmar, etc.	M	NTSC
Europe	Russia, etc.	D/K	SECAM
	Czech Republic, Poland, etc.		
	Germany, Holland, Belgium, etc.	B/G	PAL
	UK, etc.	I	
Oceania	Australia, New Zealand, etc.	B/G	PAL
Africa	Republic of South Africa, etc.	I	PAL
	Nigeria, etc.		
	Egypt, Morocco, etc.	B/G	SECAM

### PC Signals that can be displayed

- If the signal doesn't appear, check that the vertical frequency on the PC is set to "60Hz".

Resolution	640 x 480(VGA) / 1024 x 768(XGA)
Vertical frequency (Hz)	60.0

### What is "Clear SD"

LCD picture is unstable due to a large number of signal noise. Such noise appears extensively especially when an LCD displays SD signals. Clear SD mode resolves disadvantage for better picture quality.



No use "Clear SD"



Use "Clear SD"

### Connect "DVI" devices

Connect a "DVI" device to "HDMI-1" using "DVI-HDMI" conversion cable. Connect analogue sound output of the DVI device to L and R terminals in IN HDMI-1.

- Set "Audio" in "HDMI Setting" to "Analogue" or "Auto" (P. 12)
- HDMI-2 input does not support analogue sound (IN HDMI-1).
- HDMI-2 input does not support DVI devices.

## CH / CC List

To use the Insert function (P. 6), find the “CH/CC” number corresponding to the TV’s channel number from this table.

US: The US channel numbers are the channel numbers used in the United States, Philippines, etc.

CCIR: The CCIR channel numbers are the channel numbers used in the Middle East, Southeast Asia, etc.

OIRT: The OIRT channel numbers are the channel numbers used in Eastern Europe, Russia, Vietnam, etc.

AUSTRALIA: The AUSTRALIA channel numbers are the channel numbers used in Australia, etc.

CH	Channel			
	US	CCIR	OIRT	AUSTRALIA
CH 02	US-02	E2	R1	AU-0
CH 03	US-03	E3		AU-1
CH 04	US-04	E4	R2	AU-2
CH 05	US-05	E5	R6	AU-6
CH 06	US-06	E6	R7	AU-7
CH 07	US-07	E7	R8	AU-8
CH 08	US-08	E8	R9	AU-9
CH 09	US-09	E9		
CH 10	US-10	E10	R10	AU-10
CH 11	US-11	E11	R11	AU-11
CH 12	US-12	E12	R12	
CH 13	US-13			
CH 14	US-14, W+29			
CH 15	US-15, W+30			
CH 16	US-16, W+31			
CH 17	US-17, W+32			
CH 18	US-18, W+33			
CH 19	US-19, W+34			
CH 20	US-20, W+35			
CH 21	US-21, W+36	E21		
CH 22	US-22, W+37	E22		
CH 23	US-23, W+38	E23		
CH 24	US-24, W+39	E24		
CH 25	US-25, W+40	E25		
CH 26	US-26, W+41	E26		
CH 27	US-27, W+42	E27		
CH 28	US-28, W+43	E28		
CH 29	US-29, W+44	E29		
CH 30	US-30, W+45	E30		
CH 31	US-31, W+46	E31		
CH 32	US-32, W+47	E32		
CH 33	US-33, W+48	E33		
CH 34	US-34, W+49	E34		
CH 35	US-35, W+50	E35		
CH 36	US-36, W+51	E36		
CH 37	US-37, W+52	E37		
CH 38	US-38, W+53	E38		
CH 39	US-39, W+54	E39		
CH 40	US-40, W+55	E40		
CH 41	US-41, W+56	E41		
CH 42	US-42, W+57	E42		
CH 43	US-43, W+58	E43		
CH 44	US-44, W+59	E44		
CH 45	US-45, W+60	E45		
CH 46	US-46, W+61	E46		
CH 47	US-47, W+62	E47		

CH 48	US-48, W+63	E48		
CH 49	US-49, W+64	E49		
CH 50	US-50, W+65	E50		
CH 51	US-51, W+66	E51		
CH 52	US-52, W+67	E52		
CH 53	US-53, W+68	E53		
CH 54	US-54, W+69	E54		
CH 55	US-55, W+70	E55		
CH 56	US-56, W+71	E56		
CH 57	US-57, W+72	E57		
CH 58	US-58, W+73	E58		
CH 59	US-59, W+74	E59		
CH 60	US-60, W+75	E60		
CH 61	US-61, W+76	E61		
CH 62	US-62, W+77	E62		
CH 63	US-63, W+78	E63		
CH 64	US-64, W+79	E64		
CH 65	US-65, W+80	E65		
CH 66	US-66, W+81	E66		
CH 67	US-67, W+82	E67		
CH 68	US-68, W+83	E68		
CH 69	US-69, W+84	E69		

CC	Channel			
	US	CCIR	OIRT	AUSTRALIA
CC 01		S-1		AU-5
CC 02		S-2		
CC 03		S-3		
CC 04		S-4		
CC 05		S-5		
CC 06		S-6		AU-5A
CC 07		S-7		
CC 08		S-8		
CC 09		S-9		
CC 10		S-10		
CC 11		S-11		
CC 12		S-12		
CC 13		S-13		
CC 14	A	S-14		
CC 15	B	S-15		
CC 16	C	S-16		
CC 17	D	S-17		
CC 18	E	S-18		
CC 19	F	S-19		
CC 20	G	S-20		
CC 21	H	S-21		
CC 22	I	S-22		
CC 23	J	S-23		

CC 24	K	S-24		
CC 25	L	S-25		
CC 26	M	S-26		
CC 27	N	S-27		
CC 28	O	S-28		
CC 29	P	S-29		
CC 30	Q	S-30		
CC 31	R	S-31		
CC 32	S	S-32		
CC 33	T	S-33		
CC 34	U	S-34		
CC 35	V	S-35		
CC 36	W	S-36		
CC 37	W+1	S-37		
CC 38	W+2	S-38		
CC 39	W+3	S-39		
CC 40	W+4	S-40		
CC 41	W+5	S-41		
CC 42	W+6			
CC 43	W+7			
CC 44	W+8			
CC 45	W+9			
CC 46	W+10			
CC 47	W+11			
CC 48	W+12			
CC 49	W+13			
CC 50	W+14			
CC 51	W+15			
CC 52	W+16			
CC 53	W+17			
CC 54	W+18			
CC 55	W+19			
CC 56	W+20			
CC 57	W+21			
CC 58	W+22			
CC 59	W+23			
CC 60	W+24			
CC 61	W+25			
CC 62	W+26			
CC 63	W+27			
CC 64	W+28			
CC 75		X		
CC 76		Y	R3	
CC 77		Z	R4	AU-3
CC 78		Z+1	R5	
CC 79		Z+2		AU-4
CC 95	A-5			
CC 96	A-4			
CC 97	A-3			
CC 98	A-2			
CC 99	A-1			

# Specification

## Main unit

Model	LT-32EX18	LT-42EX18
Broadcasting systems	B / G / I / D / K / M	
Colour systems	PAL, SECAM, NTSC 3.58 / NTSC 4.43 MHz	
Channels and frequencies	VHF low channel (VL) = 46.25 to 140.25 MHz VHF high channel (VH) = 147.25 to 423.25 MHz UHF channel (U) = 431.25 to 863.25 MHz Receives cable channels in mid band (X to Z+2, S1 to S10), super band (S11 to S20) and hyper band (S21 to S41).	
Sound-multiplex systems	NICAM (I / B / G / D / K), A2 (B / G / D / K)	
Teletext systems	FLOF (Fasttext), WST (Standard system)	
Power requirements	AC 110 V - 240 V, 50/60Hz	
Audio output (Rated power output)	6 W + 6 W	10 W + 10 W
Speakers	(16 cm x 4 cm) x 2	(16 cm x 4 cm) x 2
Power consumption [standby]	129 W [1.3 W]	203 W [1.2 W]
Screen size (visible area size measured diagonally)	80 cm	105 cm
Dimensions (W x H x D: mm) [without stand]	791 x 571.7 x 230.5 [791 x 520.5 x 103.9]	1014 x 698 x 296 [1014 x 646.5 x 108.7]
Weights [without stand]	12.6 kg [11.9 kg]	22 kg [20 kg]
Accessories	Remote control unit : RM-C2020 x 1 AAA/R03 dry cell battery x 2 Screw x 4	

## Terminals / Connectors

Terminal name	Terminal type	Signal type (IN)	Signal type (OUT)
Input terminals	VIDEO-1	RCA connectors x 6	Composite video, Analogue component 576i (625i) / 480i (525i), Progressive : 576p (625p) / 480p (525p), HD : 1080i (1125i), 720p (750p) / 1080p (1125p) Audio L / R
	VIDEO-2	RCA connectors x 3	Composite video, Audio L / R
	HDMI-1	HDMI connector x 1	HDMI 576i (625i) / 480i (525i) / 576p (625p) / 480p (525p), 720p (750p) / 1080p (1125p) / 1080i (1125i)
	HDMI-2	HDMI connector x 1	
	IN HDMI-1	RCA connectors x 2	Audio L / R
	PC INPUT	D-SUB (15 pins) x 1	Analogue PC signal
	PC AUDIO	PC-IN (3.5 pinjack) x 1	Audio
Output terminals	MONITOR OUT	RCA connectors x 3	Composite video, Audio L / R
	Headphone	Stereo mini-jack x 1 (3.5 mm in diameter)	Headphone output

• We may change the design and specifications without notice.



# JVC