

JVC

ENGLISH
DEUTSCH
FRANÇAIS

LT-26C31BUE
LT-26C31SUE
LT-26C31BJE
LT-26C31SJE

LCD FLAT TELEVISION

INSTRUCTIONS

LCD-FLACHBILD-FERNSEHER
TELEVISEUR A ECRAN PLAT - LCD

BEDIENUNGSANLEITUNG
MANUEL D'INSTRUCTIONS



D.I.S.T.
Digital Image Scaling Technology

InteriArt

T-V LINK

*plain English
approved*
by the word centre

■ Warning

DO NOT cut off the mains plug from this equipment. If the plug fitted is not suitable for the power points in your home or the cable is too short to reach a power point, then obtain an appropriate safety approved extension lead or adaptor or consult your dealer.

If nonetheless the mains plug is cut off, remove the fuse and dispose of the plug immediately, to avoid a possible shock hazard by inadvertent connection to the mains supply.

If a new mains plug has to be fitted, then follow the instruction given below:

Important

Do not make any connection to the larger terminal which is marked with the letter E or by the safety earth symbol \perp or coloured green or green-and-yellow.

The wires in the mains lead on this product are coloured in accordance with the following code:

Blue: Neutral

Brown: Live

As these colours may not correspond with the coloured marking identifying the terminals in your plug proceed as follows:

The wire which is coloured blue must be connected to the terminal which is marked with the letter N or coloured black.

The wire which is coloured brown must be connected to the terminal which is marked with the letter L or coloured red.

When replacing the fuse, use only a correctly rated approved type and always re-fit the fuse cover.

■ If in doubt — consult a competent electrician.

How to replace the fuse

Open the fuse compartment with a blade screwdriver, and replace the fuse.

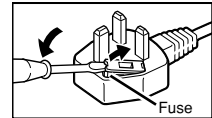

■ Guidelines for safe operation

This equipment has been designed and manufactured to comply with international safety standards. However, as with any electrical appliance, care must be taken to ensure optimal results and operational safety.

- Before attempting to use this equipment, read the operating instructions thoroughly.
- Ensure that all electrical connections (including the mains plug, extension leads, etc.) have been made in accordance with the manufacturer's instructions.
- If ever in doubt about the installation, operation or safety of this equipment, consult your dealer.
- Handle all glass panels or covers with care.
- Never operate this equipment if it appears damaged or operates abnormally. Turn the power off, disconnect the main power plug and consult your dealer.
- Never remove any affixed panels or covers. Doing so may result in electrical shock.
- Never leave this equipment operating unattended unless otherwise specifically stated that it is designed to do so or in standby mode. Only use the designated power switch to turn off the power and ensure that all potential users are instructed how to do so. Make special arrangements for infirm or handicapped persons.
- Never watch TV while operating a motor vehicle. It is illegal to watch TV while driving.
- Never listen to headphones at high volume. Doing so may damage your hearing.
- Never obstruct the ventilation of this equipment. Doing so may cause overheating and result in a malfunction or damage.
- Never use makeshift stands or attempt to affix legs with wood screws. When using a manufacturer's approved stand or legs, use only the fixtures provided and follow the installation instructions.
- Never allow this equipment to be exposed to rain or moisture.
- Never allow anyone, especially children, to insert anything into an opening in the case. Doing so may result in a fatal electrical shock.
- Never guess or take chances with electrical equipment of any kind. It is better to be safe than sorry.

Thank you for buying this JVC LCD flat television.
To make sure you understand how to use your new TV, please read this manual thoroughly before you begin.
("LCD" stands for Liquid Crystal Display.)

WARNING: TO PREVENT FIRE OR SHOCK HAZARD, DO NOT EXPOSE THIS APPLIANCE TO RAIN OR MOISTURE.

WARNING

Always use the power cord which is supplied with the TV.

WARNING

- Fingers may be trapped under the TV causing injuries. Hold the TV at the bottom in the middle, and do not allow it to tilt up or down.

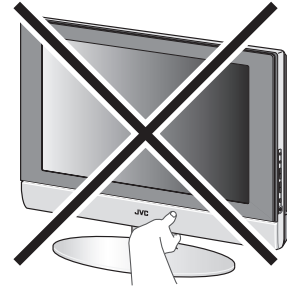

- The TV may fall causing injuries. Hold the bottom of the stand with your hand and tilt the TV up and down.

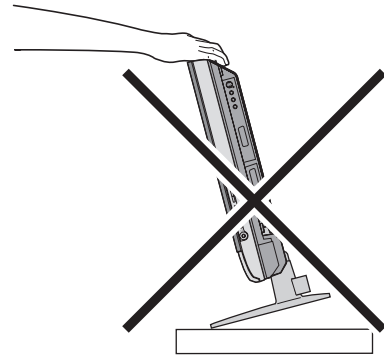

- To ensure safety in an emergency such as an earthquake, and to prevent accidents, ensure that measures are taken to prevent the TV dropping or falling over. Use the supplied screws to firmly attach the supplied hooks to the back of the TV, and use commercially available cord to fix the TV to rigid components such as walls and columns.

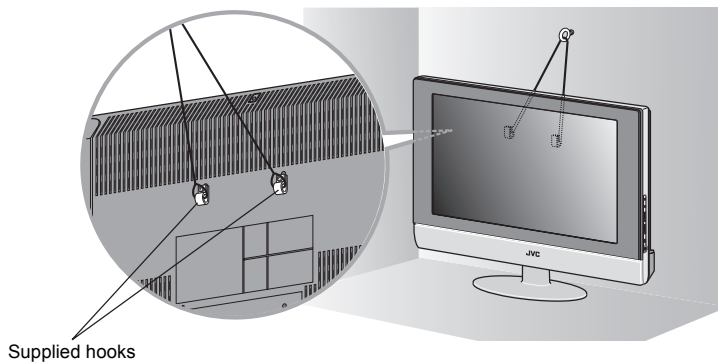

CAUTION

Do not press hard on the speaker area at the bottom front panel of the TV.
Doing so can dent the metal grid.

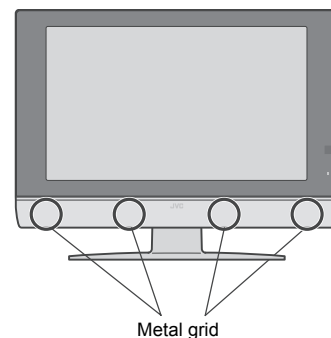

Pixel defects

LCDs use collections of fine points (“pixels”) to display images. While there is no problem with more than 99.99% of these pixels, please understand that a very small number of pixels may not light, or may light all the time.

Distance recommendations

Avoid improper installation and never position the unit where good ventilation is impossible.

When installing this TV, distance recommendations must be maintained between the set and the wall, as well as inside a tightly enclosed area or piece of furniture.

Keep to the minimum distance guidelines shown for safe operation.

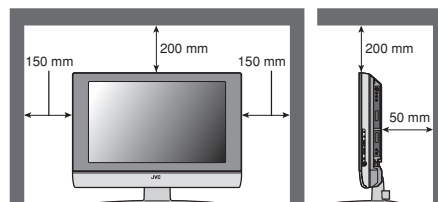

Failure to take the following precautions may cause damage to the television or remote control.

DO NOT block the TV’s ventilation openings or holes.

(If the ventilation openings or holes are blocked by a newspaper or cloth, etc., the heat may not be able to get out.)

DO NOT place anything on top of the TV.

(such as cosmetics or medicines, flower vases, potted plants, cups, etc.)

DO NOT allow objects or liquid into the cabinet openings.

(If water or liquid is allowed to enter this equipment, fire or electric shock may be caused.)

DO NOT place any naked flame sources, such as lighted candles, on the TV.

DO NOT subject the TV to direct sunlight.

The surface of the TV screen is easily damaged. Be very careful with it when handling the TV.

Should the TV screen become soiled, wipe it with a soft dry cloth. Never rub it forcefully.

Never use any cleaner or detergent on it.

If there is a fault, unplug the unit and call a service technician. Do not attempt to repair it yourself or remove the rear cover.

■ Cleaning the screen

The screen is coated with a special thin film to reduce reflection. If this film is damaged, uneven colors, discoloration, scratches, and other problems that cannot be repaired may occur. Pay attention to the following when handling the screen.

- Do not use glue or adhesive tape on the screen.
- Do not write on the screen.
- Do not allow the screen to come in contact with any hard objects.
- Do not allow condensation to form on the screen.
- Do not use alcohol, thinner, benzene or other solvents on the screen.
- Do not rub the screen hard.

CAUTION:

- Operate only from the power source specified (AC 110 – 240 V, 50/60 Hz) on the unit.
- Avoid damaging the AC plug and power cord.
- When you are not using this unit for a long period of time, it is recommended that you disconnect the power cord from the main outlet.
- The ambient temperature for using this unit is 0° to 40°C (32° to 104°F). Using the unit outside of this range may lead to it not working correctly or being broken.

D.I.S.T. demonstration

To start the D.I.S.T. demonstration:

Press the **OK** button to display the MENU (main menu). Then press the yellow button.

A picture split in two (D.I.S.T. turned on and D.I.S.T. turned off) will appear on the screen.

To quit the D.I.S.T. demonstration:

Press the yellow button, **TV** button, **P** \vee/\wedge buttons or any of the number buttons.

CONTENTS

Setting up your TV	4
Installation.....	4
Using the stand.....	4
Putting the batteries into the Remote control.....	5
Remove the terminal cover.....	5
Connecting the aerial and video cassette recorder (VCR).....	6
Connecting the power cord to the AC outlet.....	6
Initial settings	7
T-V LINK functions.....	8
TV buttons and functions	9
Turn the TV on from standby mode.....	9
Choose a TV channel.....	9
Watch images from external devices.....	9
Adjust the volume.....	9
Using the headphone.....	9
Using the Menu.....	9
Remote control buttons and functions	10
Turn the TV on or off from standby mode.....	10
Choose a TV channel.....	10
Adjust the volume.....	11
Watch images from external equipment.....	11
ZOOM function.....	12
3D SOUND function.....	12
Displaying the current time.....	13
Return to TV channel instantly.....	13
Using the FREEZE function.....	13
Using the PIP function.....	13
Using the MULTI-PICTURE function.....	14
Operating a JVC brand VCR or DVD player.....	14
Teletext function	15
Basic operation.....	15
Using the List Mode.....	15
Hold.....	15
Sub-page.....	16
Reveal.....	16
Size.....	16
Index.....	16
Cancel.....	16
Using the TV's menu	17
Basic operation.....	17
PICTURE SETTING	18
PICTURE MODE.....	18
Picture Adjustment.....	18
COLOUR TEMP.....	18
PICTURE FEATURES	19
DIGITAL VNR.....	19
Super DigiPure.....	19
COLOUR SYSTEM.....	20
MOVIE THEATRE.....	20
4:3 AUTO ASPECT.....	20
COLOUR MANAGEMENT.....	20
PIP (picture-in-picture).....	20

SOUND SETTING	21
STEREO / I • II.....	21
Sound Adjustment.....	21
SPEAKER.....	21
BBE.....	21
3D SOUND.....	21
A.H.B. (Active Hyper Bass).....	21
HEADPHONE.....	22
EXT SETTING	23
S-IN (S-VIDEO input).....	23
ID LIST.....	23
DUBBING.....	23
FEATURES	25
SLEEP TIMER.....	25
BLUE BACK.....	25
CHILD LOCK.....	25
DECODER (EXT-2).....	26
INSTALL	27
LANGUAGE.....	27
AUTO PROGRAM.....	27
EDIT/MANUAL.....	28
Additional menu operations	31
Using the ACI function.....	31
Downloading data to a VCR.....	31
Changing the COUNTRY setting.....	32
Using the DECODER (EXT-2) function.....	32
Additional preparation	33
Connecting external equipment.....	33
CH/CC numbers	35
Troubleshooting	36
Specifications	38

Setting up your TV

- When you install the TV on the wall, only use a JVC wall mounting unit (optional) which is designed for this TV.
- Make sure that the TV is installed on the wall by a skilled installer.

Installation

Cautions for installation

- Install the TV in a corner on a wall or on the floor so as to keep cords out of the way.
- The TV will generate a slight amount of heat during operation. Ensure that sufficient space is available around the TV to allow satisfactory cooling. See “Distance recommendations” on page 2.

A protective sheet is fitted to the TV panel frame.

Using the stand

This TV comes with a table top stand already attached.

This stand can be used to adjust the direction of the TV screen 5° up, 10° down, and 20° to the left or right.

■ Tilt the TV up and down:

While holding the bottom of the stand with one hand, use your other hand to hold the middle of the top of the TV and slowly tilt the TV up and down.

- As a safety measure, the stand needs a certain amount of force to tilt the TV.

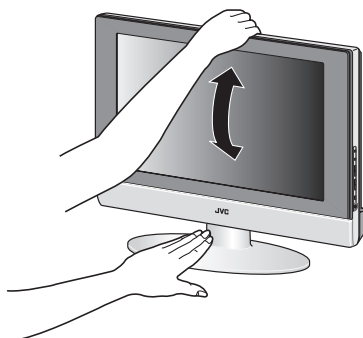

■ Rotate the TV to the left and right:

While holding the bottom of the stand with one hand, use your other hand to hold the edge of the panel and slowly adjust the direction of the TV screen.

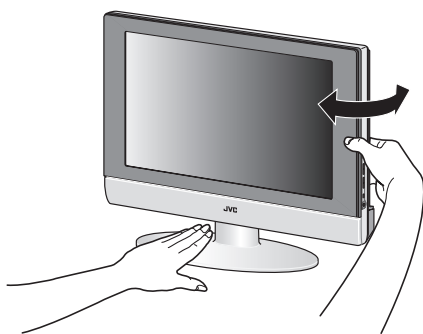

■ Cable holder

A cable holder which is used to keep the connection cables tidy is attached to the back of the stand. Gently squeeze the left and right of the cable holder and pull it to remove it from the stand. After putting the cables in the cable holder, attach it to the back of the stand again.

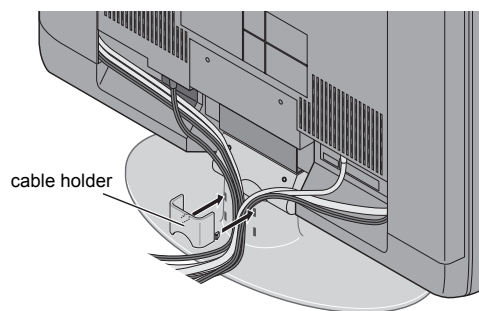

Putting the batteries into the Remote control

Use two AA/R6 dry cell batteries.

Insert the batteries from the \ominus end, making sure the \oplus and \ominus polarities are correct.

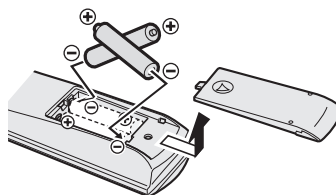

- Follow the warnings printed on the batteries.
- Battery life is about six months to one year, depending on your frequency of use.
- The batteries we supply are only for setting up and testing your TV, please replace them as soon as you need to.
- If the remote control does not work properly, replace the batteries.

Remove the terminal cover

There are connection terminals behind the covers on the left and right of the rear of the TV. Remove these two covers before connecting an antenna or VCR.

The covers can be removed by removing the hook at the bottom and then pulling out while lifting slightly. To replace the covers, first connect the hook at the top of the cover to the TV and then insert the hook at the bottom.

- Leave the covers off if they do not fit properly. Do not force to replace the covers. Doing so may cause damage to the connection cables and the covers.
- Leave these covers off when mounting the TV on a wall.

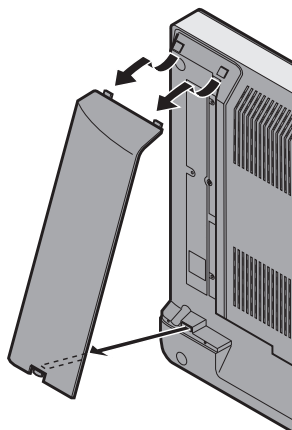

Connecting the aerial and video cassette recorder (VCR)

- The connecting cables are not provided.
- For further details, refer to the manuals provided with the devices to be connected.

■ If you are connecting a VCR, follow ① → ② → ③ in the diagram opposite.

■ If you are not connecting a VCR, follow ①.

To use the T-V LINK functions, you must have a T-V LINK compatible VCR connected by a SCART cable ③ to the EXT-2 terminal on the TV. For details about T-V LINK functions, see “T-V LINK functions” on page 8.

- You can watch a video using the VCR without doing ③. For details, see your VCR instruction manual.
 - To connect more equipment, please see “Connecting external equipment” on page 33.
 - To connect additional audio equipment, see “Connecting Speakers/Amplifier” on page 34.
 - If you connect a decoder to a T-V LINK compatible VCR, set the DECODER (EXT-2) function to ON. For details, see “Using the DECODER (EXT-2) function” on page 32.
- Otherwise, you will not be able to watch scrambled channels.

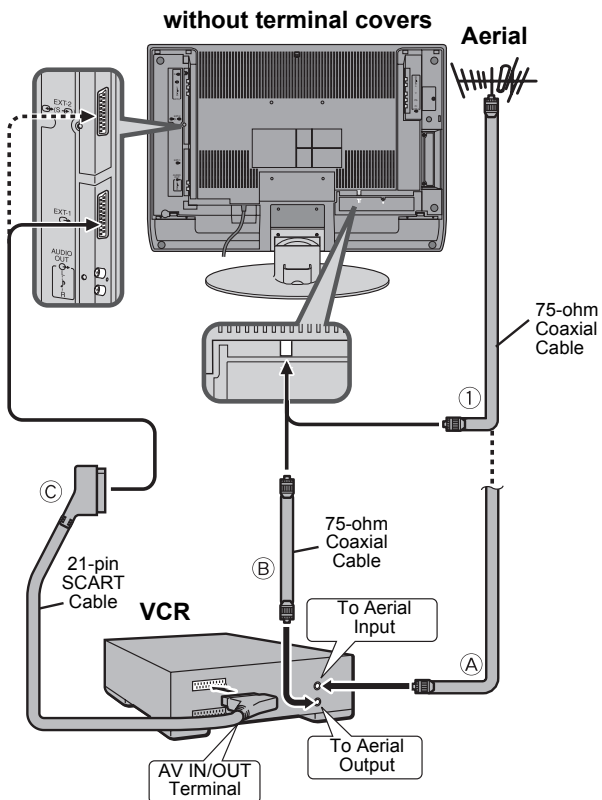

Connecting the power cord to the AC outlet

Insert the AC plug on the power cord from the TV into an AC outlet.

Caution

- Operate only from the power source specified (AC 110 – 240 V, 50/60 Hz) on the unit.

- Remove the AC plug from the outlet to completely disconnect the TV from the power supply.

Initial settings

When the TV is first turned on, it enters the initial setting mode, and the JVC logo is displayed. Follow the instructions on the on-screen display to make the initial settings.

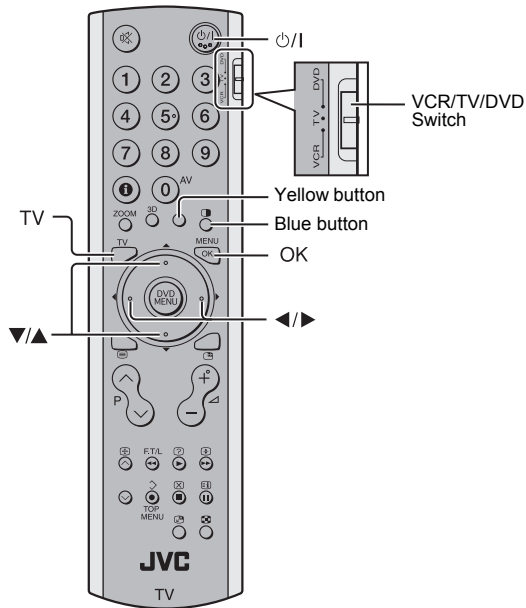

1 Make sure to set the VCR/TV/DVD switch to the TV position.

- You cannot turn the TV on when the VCR/TV/DVD switch is set to the VCR or DVD position.

2 Press the P/I button on the remote control

After a short interval the TV power lamp lights and the JVC logo is displayed.

- Check that the AC plug on the power cord from the TV is connected to AC outlet.

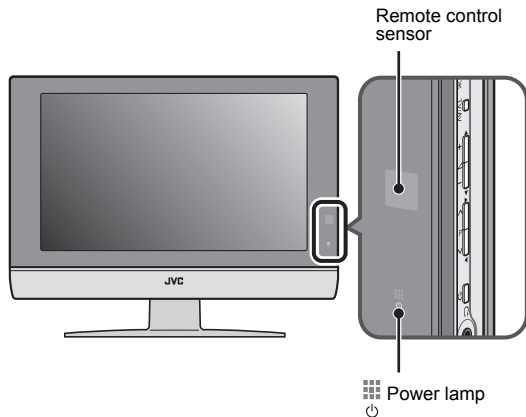

- If the JVC logo does not appear this is because your TV has already been turned on for the first time: use the "LANGUAGE" and "AUTO PROGRAM" functions to make the initial settings. For details, see "INSTALL" on page 27.

3 Press the OK button

The LANGUAGE menu appears.

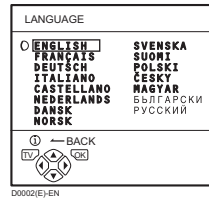

4 Press the Left/Right and Up/Down buttons to choose ENGLISH. Then press the OK button

The on-screen display will then be in English.

The COUNTRY menu appears as a sub-menu of the AUTO PROGRAM function.

There are two COUNTRY menus. Pressing the yellow button changes the COUNTRY menu as follows:

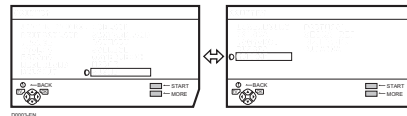

5 Press the Left/Right and Up/Down buttons to choose the country where you are

- For uses in the UK:

To receive SKY 1 you need a satellite tuner. You must have the satellite tuner set to SKY 1 before starting the AUTO PROGRAM function which follows.

6 Press the blue button to start the AUTO PROGRAM function

The AUTO PROGRAM menu appears and received TV channels are automatically stored in the programme numbers (PR).

- To cancel the AUTO PROGRAM function: Press the TV button.

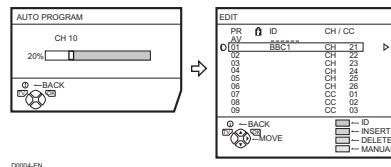

After the TV channels have been registered in the programme numbers (PR), the EDIT menu appears

- If you want to, you can now edit the programme numbers (PR) using the EDIT/MANUAL function. For details, see "EDIT/MANUAL" on page 28.
- If you do not want to edit programme numbers (PR), go to the next step.

If "ACI START/ACI SKIP" appears in the AUTO PROGRAM menu:

You can use the ACI (Automatic Channel Installation) function to decode the ACI data and complete the registration of all the TV channels quickly. For details of the ACI function and how to use it, see "Using the ACI function" on page 31.

If you don't want to use the ACI function, press the Up/Down buttons to choose ACI SKIP and then press OK.

7 Press the **OK** button to display the T-V LINK menu

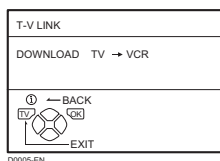

8 If you do not have a T-V LINK compatible VCR connected:

Press the **TV** button to exit the T-V LINK menu. The T-V LINK menu disappears.

If you have a T-V LINK compatible VCR connected to the EXT-2 terminal:

Follow the operating procedure “Downloading data to a VCR” on page 31 to transmit the programme number (PR) data.

Now, the initial settings are complete, and you can watch the TV

- **When the COUNTRY setting is UNITED KINGDOM:**
BBC1, BBC2, ITV, Channel 4 and Channel 5 are automatically set to the programme numbers PR1 to PR5. If the TV doesn't receive one of these TV channels, that programme number (PR) will not be set. Programme number PR6 is not normally set.
- **When the COUNTRY setting is not UNITED KINGDOM:**
If your TV can detect the TV channel name from the TV channel broadcast signal, the TV channel name is assigned to the programme number (PR) to which the TV channel has been set. However, which TV channels are set to which programme numbers (PR) will depend on the area in which you live.
- If a TV channel you want to view is not set to a programme number (PR), you can set it using the **MANUAL** function. For details, see “EDIT/MANUAL” on page 28.
- The **AUTO PROGRAM** function does not set the programme number PR 0 (AV) for your video cassette recorder. You will need to set this using the **MANUAL** function.
- In some areas you may get TV reception from more than one transmitter, for example different ITV regions. In this case each TV channel could be set twice. If this happens, the first set of channels will have the stronger signal. If you want to delete the second set of channels, you will have to do it manually (see page 30).

For users in the UK:

If you have any problems setting up your new TV, please call the **JVC** Helpline on **0870 330 5000**.

For users in the Republic of Ireland:

If you have any problems setting up your new TV, please call the **JVC** Helpline on **1890-582500**.

T-V LINK functions

When you have a T-V LINK compatible VCR connected to the EXT-2 Terminal on the TV, it is easier to set up the VCR and to view videos. T-V LINK uses the following features:

To use T-V LINK functions:

A “T-V LINK compatible VCR” means a JVC video cassette recorder with the T-V LINK logo, or with one of the following logos. However, these VCRs may support some or all of the features described earlier. For details, see your VCR instruction manual.

- “Q-LINK” (a trademark of Panasonic Corporation)
- “Data Logic” (a trademark of Metz Corporation)
- “Easy Link” (a trademark of Phillips Corporation)
- “Megalogic” (a trademark of Grundig Corporation)
- “SMARTLINK” (a trademark of Sony Corporation)

■ Pre-set download

The VCR will automatically download the registered data on the TV channels from the TV. This means you do not need to set up the program channels on your VCR manually. The preset download function automatically begins when the initial setting is complete or whenever you carry out the **AUTO PROGRAM** or **EDIT/MANUAL** functions.

You can also carry out this function using your VCR controls.

When “FEATURE NOT AVAILABLE” is displayed:

If “FEATURE NOT AVAILABLE” is displayed, the download was not performed correctly. Before trying to download again, check that:

- the VCR power is turned on
- the VCR is T-V LINK compatible
- the VCR is connected to the EXT-2 terminal
- the SCART cable is fully wired.

■ Direct Rec

“What You See Is What You Record”

You can easily record to VCR the images that you are watching on the TV.

For details, read the manual for your VCR.

Use your VCR controls. “VCR IS RECORDING” is displayed.

In the following situations, the VCR will stop recording if the TV is turned off, if the TV channel or input is changed, or if the menu is displayed on the TV:

- when recording images from an external device connected to the TV (for example a camcorder)
- when recording a TV channel after it has been unscrambled on a decoder
- when recording a TV channel by using the TV's output because the VCR's own tuner cannot properly receive that channel.

When the VCR is not ready (for example when there is no tape inserted), “NO RECORDING” is displayed.

You cannot carry out Direct Rec using your TV's control.

Generally, the VCR cannot record a TV channel that it cannot receive properly on its own tuner, even if you can view that TV channel on the TV. However, some VCRs can record a TV channel by using the TV's output if that channel can be viewed on the TV. For details, see your VCR instruction manual.

■ TV auto power on/VCR image view

When the VCR starts playing, the TV automatically turns on and the images from the EXT-2 terminal appear on the screen.

When the VCR menu is operated, the TV automatically turns on and the images from the EXT-2 terminal appear on the screen.

- Check that the AC plug on the power cord from the TV is connected to an AC outlet.

TV buttons and functions

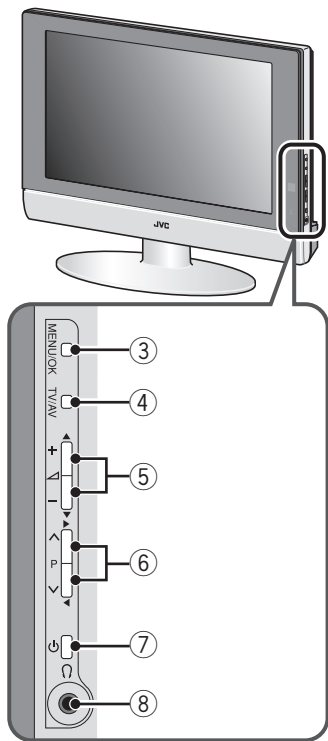
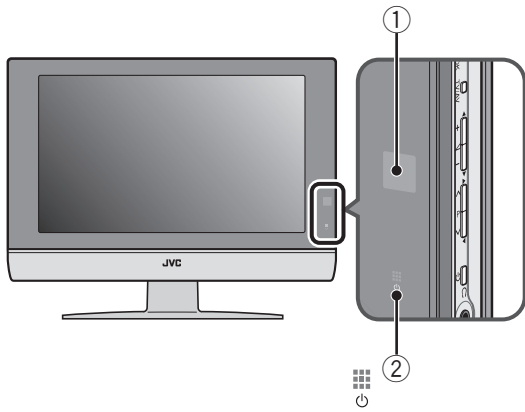

Refer to the pages in parentheses for details.

- ① Remote control sensor
- ② Power lamp (page 7)
- ③ MENU/OK button (pages 9, 17)
- ④ TV/AV button (page 9)
- ⑤ ∇/Δ (Volume) $-/+$ buttons (page 9)
- ⑥ P ∇/Δ buttons (page 9)
- ⑦ ⏻ (Stand by) button (page 9)
- ⑧ Headphone jack (mini jack) (page 33)

Turn the TV on from standby mode

Press the ⏻ button or P ∇/Δ buttons to turn the TV on from standby mode

- Check that the AC plug on the power cord from the TV is connected correctly to an AC outlet.

Choose a TV channel

Press the P ∇/Δ buttons to choose a programme number (PR) or an EXT terminal

Watch images from external devices

Press the TV/AV button to choose a TV/AV terminal

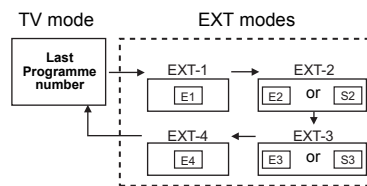

Adjust the volume

Press the $-/+$ buttons

The volume level indicator appears.

Using the headphone

- The headphone volume is adjusted with the "HEADPHONE" menu (see page 22).

Using the Menu

Use the MENU/OK button.

Refer to "Using the TV's menu" (see page 17) for details of using the menu.

Remote control buttons and functions

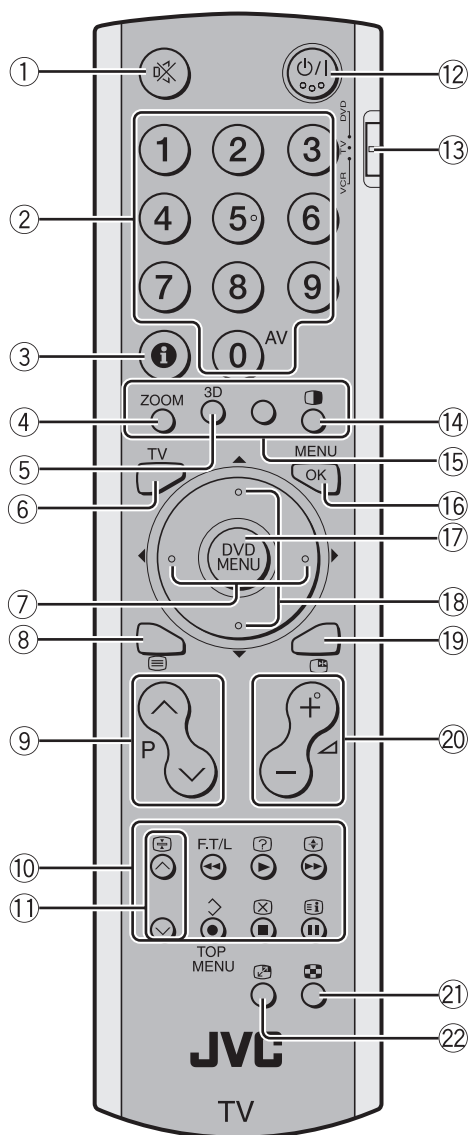

- ① Muting button
- ② Number buttons
- ③ Information button
- ④ **ZOOM** button
- ⑤ **3D** sound button
- ⑥ **TV** button
- ⑦ ◀▶ buttons
- ⑧ ☰ (Text) button
- ⑨ **P** ∨/∧ buttons
- ⑩ VCR/DVD/Teletext control buttons
- ⑪ ∨/∧ buttons
- ⑫ Standby button
- ⑬ VCR/TV/DVD switch
- ⑭ ■ button
- ⑮ Colour buttons
- ⑯ **OK** button
- ⑰ **DVD MENU** button
- ⑱ ▼/▲ buttons
- ⑲ ■ button
- ⑳ ▽/▲ buttons
- ㉑ ■ button
- ㉒ ■ button

Turn the TV on or off from standby mode

1 Make sure to set the VCR/TV/DVD switch to the TV position.

- You cannot turn the TV on or off when the VCR/TV/DVD switch is set to the VCR or DVD position.

2 Press the ⏻ (standby) button to turn the TV on or off.

When the TV is turned on, the power lamp lights.

- The power can be turned on by pressing the **TV** button, **P** ∨/∧ buttons or Number buttons.
- Check that the AC plug on the power cord from the TV is connected to an AC outlet.

Choose a TV channel

■ Use the number buttons:

Enter the programme number (PR) of the channel using the number buttons.

Example:

- PR 6 → press **6**
- PR 12 → press **1** and **2**

■ Use the **P** ∨/∧ buttons:

Press the **P** ∨/∧ buttons to choose the programme number (PR) you want.

■ Use the PR LIST:

1 Press the **i** (information) button to display the PR LIST

Pressing the **i** (information) button changes the display as follows:

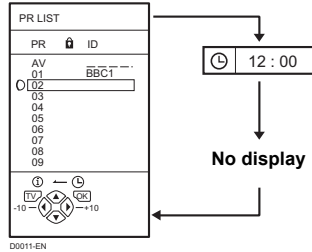

2 Press the **◀/▶** and **▼/▲** buttons to choose a programme number (PR). Then press the **OK** button

- For programme numbers (PR) with the CHILD LOCK function set, the **Ⓛ** (CHILD LOCK) mark appears next to the programme number (PR) in the PR LIST.
- You cannot use the **▼/▲** buttons to choose a programme number (PR) with the CHILD LOCK function set.
- Even if you try to choose a programme number (PR) with the CHILD LOCK function set, the **Ⓛ** (CHILD LOCK) mark will appear, and you cannot watch the TV channel. To watch the TV channel, see “CHILD LOCK” on page 25.

■ Use the PR LIST:

1 Press the **i** (information) button to display the PR LIST

2 Press the **◀/▶** and **▼/▲** buttons to choose an EXT terminal. Then press the **OK** button

- The EXT terminals are registered after the programme number PR 99.
- You can choose a video input signal from the S-VIDEO signal (Y/C signal) and regular video signal (composite signal). For details, see “S-IN (S-VIDEO input)” on page 23.
- If you do not have a clear picture or no colour appears, change the colour system manually. See “COLOUR SYSTEM” on page 20.
- This TV set has a function which can automatically change over the input according to a special signal output from an external device. (The EXT-4 terminal does not support this function.)

To return to a TV channel:

Press the **TV** button, the **P** **∨/∧** buttons or the number buttons.

To use the programme number PR 0 (AV):

When the TV and VCR are connected only by the aerial cable, choosing the programme number PR 0 (AV) allows you to view images from the VCR. Set the VCR RF channel to the programme number PR 0 (AV) manually. For details, see “EDIT/MANUAL” on page 28.

Pressing the **0 (AV)** button changes the choice as follows:

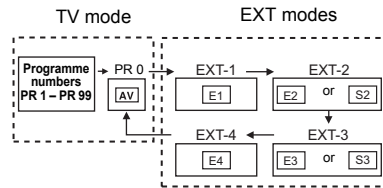

- The VCR sends its playback image along the aerial cable as an RF (radio frequency) signal.
- Also see your VCR instruction manual.

Adjust the volume

Press the **◀ -/+** buttons to adjust the volume.

The volume indicator appears and the volume changes as you press the **◀ -/+** buttons.

- The headphone volume is adjusted with the “HEADPHONE” menu (see page 22).

■ Muting the sound

Press the **Ⓜ** (muting) button to turn off the sound.

Pressing the **Ⓜ** (muting) button again restores the previous volume level.

Watch images from external equipment

■ Use the **0 (AV)** button:

Press the **0 (AV)** button to choose an EXT terminal.

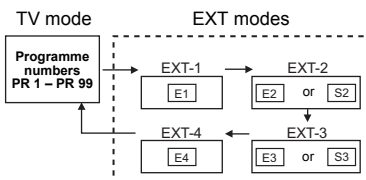

■ Use the **▼/▲** buttons:

Press the **▼/▲** buttons to choose an EXT terminal.

ZOOM function

You can change the screen size according to the picture aspect ratio. Choose the optimum one from the following ZOOM modes.

AUTO:

When a WSS (Wide Screen Signalling) signal, which shows the aspect ratio of the picture, is included in the broadcast signal or the signal from an external device, the TV automatically changes the ZOOM mode to 16:9 ZOOM mode or FULL mode according to the WSS signal. If a WSS signal is not included, the picture is displayed in accordance with the ZOOM mode set with the 4:3 AUTO ASPECT function.

- For details of the 4:3 AUTO ASPECT function, see “4:3 AUTO ASPECT” on page 20.
- When the AUTO (WSS) mode does not function correctly due to poor WSS signal quality or when you want to change the ZOOM mode, press the **ZOOM** button and change to another ZOOM mode.

REGULAR:

Use to view a normal picture (4:3 aspect ratio) as this is its original shape.



PANORAMIC:

This stretches the left and right sides of a normal picture (4:3 aspect ratio) to fill the screen, without making the picture appear unnatural.

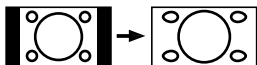

- The top and bottom of the picture are slightly cut off.

14:9 ZOOM:

This zooms up the wide picture (14:9 aspect ratio) to the upper and lower limits of the screen.



16:9 ZOOM:

This zooms up the wide picture (16:9 aspect ratio) to the full screen.



16:9 ZOOM SUBTITLE:

This zooms up the wide picture (16:9 aspect ratio) with subtitles to the full screen.

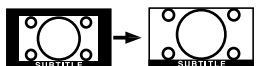

FULL:

This uniformly stretches the left and right sides of a normal picture (4:3 aspect ratio) to fill the wide TV screen.

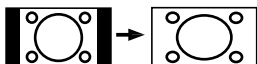

- For 16:9 aspect ratio pictures that have been squeezed into a normal picture (4:3 aspect ratio), use the FULL mode to restore the picture to its original shape.

Choose the ZOOM mode

1 Press the **ZOOM** button to display the ZOOM menu

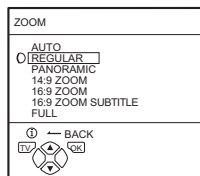

- The **ZOOM** button does not work in the twin pictures mode.

2 Press the **▼/▲** buttons to choose a ZOOM mode. Then press the **OK** button

The picture expands and the chosen ZOOM mode is displayed in about 5 seconds.

- The ZOOM mode may be automatically changed by the control signal from an external device. When you want to return to the previous ZOOM mode, choose the ZOOM mode again.

Adjusting the visible area of the picture

If subtitles or the top (or bottom) of the picture are cut off, you can adjust the visible area of the picture manually.

1 Press the **ZOOM** button

The ZOOM menu appears.

2 Press the **OK** button to display the ZOOM mode indicator

The indicator appears.

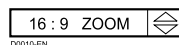

3 While it is displayed, press the **▼/▲** buttons to change the position of the picture

- You cannot adjust the visible area in REGULAR or FULL mode.

3D SOUND function

You can enjoy sounds with a wider ambience.

Press the **3D** button to turn the 3D SOUND function on or off

- The 3D SOUND function does not work properly with mono sound.
- The 3D SOUND function can be also turned on or off by using the SOUND SETTING menu. For details, see “3D SOUND” on page 21.

Displaying the current time

You can display the current time on the screen.

Press the **i** (information) button to display the current time

Pressing the **i** (information) button changes the display as follows:

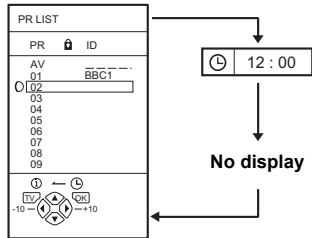

- This TV uses teletext data to set the current time. If the TV has not received a TV channel that has teletext programmes since it was turned on, the time display is blank. To see the time, choose a TV channel that has teletext programmes.
- When watching videos, an incorrect current time is sometimes displayed.

Return to TV channel instantly

You can return to a TV channel instantly.

Press the **TV** button

The TV returns to the TV mode and a TV channel appears.

Using the FREEZE function

You can view the current programme as a still picture.

1 Press the **Freeze** button

The still picture of the current picture will appear.

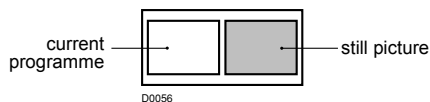

To cancel the FREEZE function:

Press the **Freeze** button, the **P** ∇/\wedge buttons or the number buttons.

- The FREEZE function does not work while a sub-picture is displayed.
- The still picture cannot be output from the TV.

Using the PIP function

You can view two pictures (Main-picture and sub-picture). Two different TV programmes can be watched at the same time, or a TV programme and a video programme from an external device can be watched at the same time.

1 Press the **PIP** button

Pressing the **PIP** button changes the PIP mode as follows:

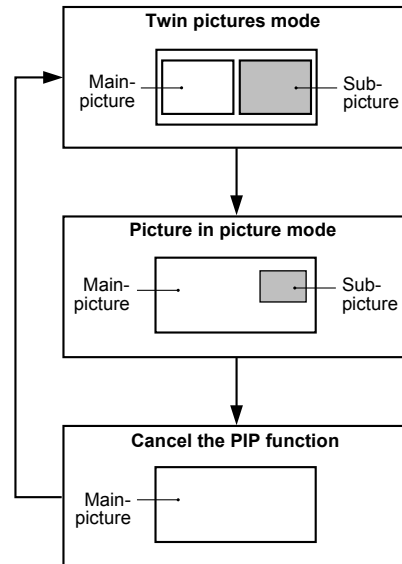

D0057

2 Press the **V/A** buttons to change the sub-picture to the picture from another EXT terminal

Listening to the sound of the sub-picture:

You can listen to the sound of the sub-picture with the headphones while listening to the sound of the main-picture from the TV speakers.

For details, see "HEADPHONE" on page 22.

- The sub-picture sound is mono.

Changing the position of the sub-picture:

You can choose one of four positions.

For details, see "PIP (picture-in-picture)" on page 20.

Swapping the main-picture and sub-picture:

Press the **Swap** button.

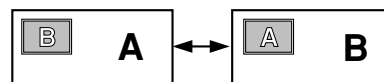
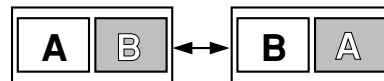

The main-picture and sub-picture will be swapped.



D0051

Cancelling the PIP function:

Press the  button or **TV** button.

- If the main-picture signal is poor, the quality of the sub-picture may also be poor.
- If the pictures have different standards, the top and bottom of one of them may be missing.
- If an external device is operated, the sub-picture may disappear. If this happens, press the  button again to redisplay the sub-picture.
- You cannot view a scrambled channel in the sub-picture. If the  (swap) button is pressed when viewing a scrambled channel in the main-picture using an external decoder, the channel you have been viewing in the sub-picture will appear in both the main-picture and sub-picture.
- The ZOOM function does not work in the twin-picture mode.
- Do not press the  (swap) button while you are recording the TV output on the VCR. If you do, the TV output signal will change.
- The BLUE BACK function does not work in the twin picture mode or the picture-in-picture mode.
- PIP function does not work for a picture of 1125i signal. See “EXT-4 terminal” on page 38 for more information on this type of signal.
- A picture of 625p or 525p signal cannot be displayed as the sub-picture. See “EXT-4 terminal” on page 38 for more information on these types of signals. Pay attention to the following.
 - When the EXT-4 picture is a picture of 625p or 525p signal, you cannot choose EXT-4 with the \vee/\wedge buttons.
 - When the EXT-4 picture signal is changed to 625p, 525p or 1125i signal while the EXT-4 picture is displayed as the sub-picture, the PIP function is cancelled.
 - The pictures cannot be swapped when a picture of 625p or 525p signal from EXT-4 is being displayed as the main picture.
- The sub-picture cannot be output from the TV.

Using the MULTI-PICTURE function

You can display multi-pictures so you can find a program you want to view.

1 Press the  button to display multi-pictures

The channels are displayed in the channel number order. The multi-pictures will appear in multi-picture mode.

12-pictures multi:

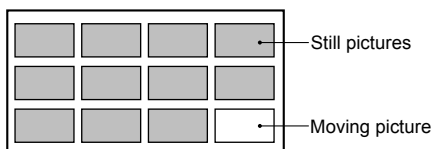

D0058-EN

2 Press the \vee/\wedge buttons to choose the screen you want to see

The chosen picture changes to a moving picture.

3 Press the OK button

The multi-pictures disappear and the chosen picture appears.

Cancelling the multi-pictures:

Press the **TV** button, the number buttons or the **OK** button.

- Pictures from external devices cannot be displayed in the 12-pictures multi mode.

Operating a JVC brand VCR or DVD player

These buttons will operate a JVC brand VCR or DVD player. Pressing a button that looks the same as the device’s original remote control button has the same effect as the original remote control.

1 Set the VCR/TV/DVD switch to the VCR or DVD position

VCR:

When you are using a VCR, set the switch to the VCR position. You can turn the VCR on or off with the $\odot/|$ (Standby) button.

DVD:

When you are using a DVD player, set the switch to the DVD position. You can turn the DVD player on or off with the $\odot/|$ (Standby) button.

2 Press the VCR/DVD Control Button to control your VCR or DVD player

- If your device is not made by JVC, these buttons will not work.
- Even if your device is made by JVC, some of these buttons may not work, depending on the device you are using.
- You can use the \vee/\wedge buttons to choose a TV channel the VCR will receive, or choose the chapter the DVD player plays back.
- Some models of DVD player use the \vee/\wedge buttons for both operating the fast forward/backward functions and for choosing the chapter. In this case, the $\blacktriangleleft/\blacktriangleright$ buttons do not work.
- Set the VCR/TV/DVD switch to the TV position when you turn the TV on or off.

■ To use DVD MENU button

Some DVDs allow you to select the disc contents using the menu. When you playback these DVDs, you can select the subtitle language and sound-track language, etc. by using the DVD menu.

1 Press DVD MENU button during play back

The DVD menu appears on the screen.

- Press **DVD MENU** button again to resume playback at the scene when you pressed the button.

2 Press \vee/\wedge or $\blacktriangleleft/\blacktriangleright$ buttons to select the desired item

3 Press OK button

The menu continues to another screen.

Repeat steps 2 and 3 to set additional items if any.

Teletext function

Basic operation

- 1 Choose a TV channel with a teletext broadcast
- 2 Make sure you set the VCR/TV/DVD switch to the TV position.



- 3 Press (Text) button to display the teletext
Pressing (Text) button changes the mode as follows:

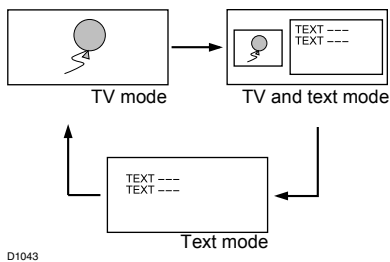

- 4 Choose a teletext page by pressing the **P** buttons, number buttons or colour buttons

To return to the TV mode:

Press the **TV** button or (Text) button.

- If you have trouble receiving teletext broadcasts, consult your local dealer or the teletext station.
- The ZOOM function will not work in the TV and text mode or Text mode.
- You cannot operate menus when viewing a teletext programme.
- Language display depends on the country which was set on the COUNTRY menu. If characters on a Teletext programme do not appear properly, change the COUNTRY Setting to other country's. For detail, "Changing the COUNTRY setting" on page 32.

Using the List Mode

You can store the numbers of your favourite teletext pages in memory and call them up quickly using the colour buttons.

■ To store the page numbers:

- 1 Press **F.T/L** button to go into the List mode

The page numbers you have stored are displayed at the bottom of the screen.

- 2 Press a Colour button to choose a position. Then press the Number buttons to enter the page number

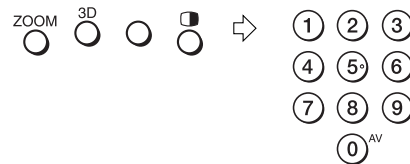

- 3 Press and hold down (Store) button

The four page numbers blink white to show that they are stored in memory.

■ To call up a stored page:

- 1 Press the **F.T/L** button to engage the List mode

- 2 Press a colour button having a stored page

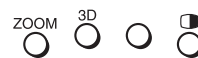

To exit the List mode:

Press the **F.T/L** button again.

Hold

You can hold a teletext page on the screen for as long as you want, even while several other teletext pages are being received.

Press the (Hold) button

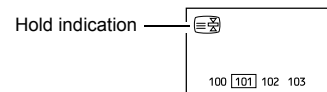

To cancel the Hold function:

Press (Hold) button again.

Sub-page

Some teletext pages include sub-pages that are automatically displayed.

1 Choose a teletext page that includes sub-pages

Sub-page numbers that can be viewed are automatically displayed at the top of the screen.

2 Press the ◀/▶ buttons to choose a sub-page number

Reveal

Some teletext pages include hidden text (such as the answers to a quiz).

You can display the hidden text.

Each time you press the  (Reveal) button, text is hidden or revealed

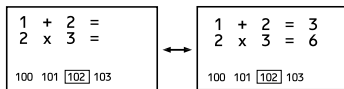

Size

You can double the height of the teletext display.

Press the  (Size) button.

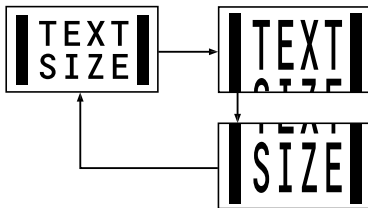

Index

You can return to the index page instantly.

Press the  (Index) button

Returns to page 100 or a previously specified page.

Cancel

You can search for a teletext page while watching TV.

1 Press the number button to enter a page number, or press a colour button

The TV searches for a teletext page.

2 Press the (Cancel) button

The TV programme appears. When the TV finds the teletext page, its page number appears in the upper left of the screen.

3 Press the (Cancel) button to return to a teletext page when the page number is on the screen

- The TV mode cannot be resumed by pressing the  (Cancel) button. To return to the TV mode press **TV**.

Using the TV's menu

This TV has a number of functions you can operate using menus. To use all your TV's functions, you need to understand the basic menu operating techniques fully.

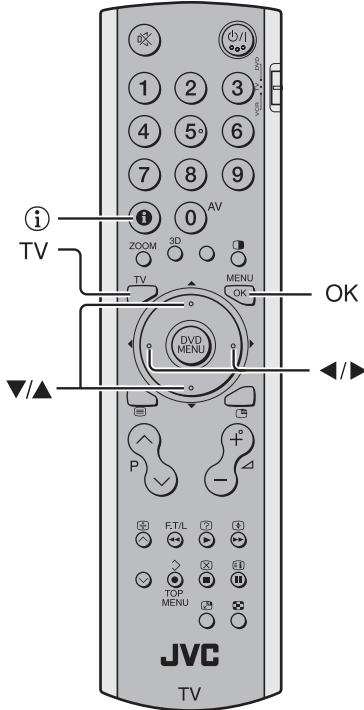

3 Press the **V/▲** buttons to choose a function

- For details of the functions in the menus, see the following pages.

4 Press the **◀/▶** buttons to choose the setting of that function

- If you want to operate a function which appears only with its name, follow the descriptions of that function on the following pages.
- The display appearing at the bottom of a menu shows you a button on the remote control that you can use when you operate a chosen function.

5 Press the **OK** button to complete the setting

The menu disappears.

- When watching the television with the NTSC system, the menus are displayed at about half of their normal vertical size.
- The menu will disappear if you press the **P** **V/▲** buttons while the menu is displayed.

Operation with the buttons on the TV

You can also operate the menus using the buttons on the front panel of the TV.

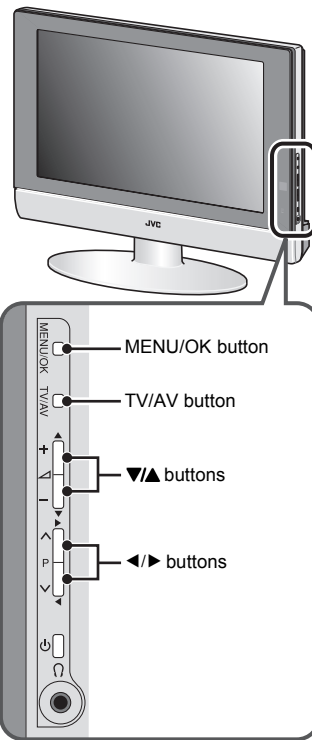

Basic operation

1 Press the **OK** button to display the **MENU** (main menu)

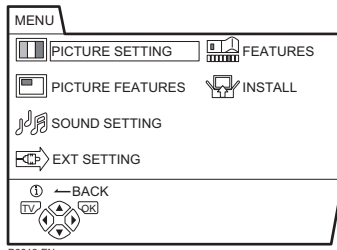

- Press the **OK** button twice while watching the MULTI-PICTURE mode.
- The display appearing at the bottom of a menu shows the buttons on the remote control you can use when you operate a chosen function.

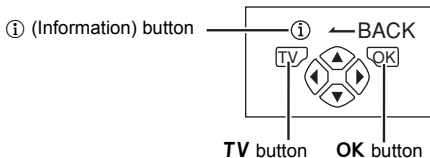

2 Press the **◀/▶** and **V/▲** buttons to choose a menu title, and press the **OK** button

The menu appears.

To return to the previous menu:

Press the **i** (information) button.

To exit a menu instantly:

Press the **TV** button.

The menu will disappear after about one minute if no operation is performed.

PICTURE SETTING

Refer to “Using the TV’s menu” (see page 17) for details of displaying the menu.

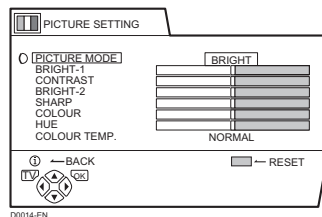

PICTURE MODE

You can choose one of three PICTURE MODEs to adjust the picture settings automatically.

BRIGHT:

Heightens contrast and sharpness.

STANDARD:

Standardizes picture adjustment.

SOFT:

Softens contrast and sharpness.

Picture Adjustment

You can change the picture settings of each PICTURE MODE mode as you like.

BRIGHT-1:

You can adjust the back light.

◀ : darker

▶ : brighter

CONTRAST:

You can adjust the picture contrast.

◀ : lower

▶ : higher

BRIGHT-2:

You can adjust the picture brightness.

◀ : darker

▶ : brighter

SHARP:

You can adjust the picture sharpness.

◀ : softer

▶ : sharper

COLOUR:

You can adjust the picture colour.

◀ : lighter

▶ : deeper

HUE:

You can adjust the picture tint.

◀ : reddish

▶ : greenish

- You can change the HUE setting (picture hue) when the colour system is NTSC 3.58, NTSC 4.43 or a signal from the EXT-4 terminal.
However, you cannot do this when the PIP function main picture is set to EXT-4.

To return to the default settings in each PICTURE MODE mode:

Press the blue button.

- This returns the picture settings in the PICTURE MODE mode you have chosen to the default settings, and stores them in the PICTURE MODE mode.

COLOUR TEMP.

You can select one of three COLOUR TEMP. modes (three tones of white) to adjust the white balance of the picture. Since white is the colour which is used as a reference for all the other colours, changing the COLOUR TEMP. mode affects the appearance of all the other colours on the screen.

COOL:

A bluish white. Using this mode when watching bright pictures allows you to enjoy a more vivid and bright picture.

NORMAL:

The normal white colour.

WARM:

A reddish white. Using this mode when watching films allows you to enjoy colours that are characteristic of films.

PICTURE FEATURES

Refer to “Using the TV’s menu” (see page 17) for details of displaying the menu.

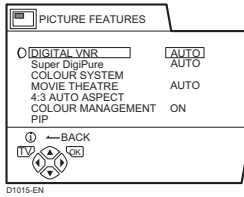

DIGITAL VNR

The DIGITAL VNR function cuts down the amount of ‘noise’ (‘snow’ or interference) in the original picture. You can choose from the three DIGITAL VNR function settings of AUTO, MIN and MAX.

AUTO:

The TV will automatically adjust the level of the DIGITAL VNR effect to match the amount of noise in the picture, giving you the best possible picture.

- If you set the DIGITAL VNR effect too high it can make the picture less sharp. It is recommended to use the AUTO setting if you can.
- AUTO cannot be chosen when you are watching the EXT-4 picture.

MIN:

The level of the DIGITAL VNR effect is set to the minimum. If you set the DIGITAL VNR function to AUTO but feel that the sharpness of the original picture has not been reproduced fully, change the setting from AUTO to MIN.

- The MIN setting is not suitable for low-quality pictures which contain a lot of noise.

MAX:

The level of the DIGITAL VNR effect is set to the maximum. If you set the DIGITAL VNR function to AUTO but still notice some noise, change the setting from AUTO to MAX.

- The MAX setting is not suitable for high-quality pictures which contain very little noise.
- When a picture of 625p, 525p, or 1125i signal is being displayed, “DIGITAL VNR” cannot be selected.
- The DIGITAL VNR function does not work for pictures of 625p, 525p and 1125i signals.
- See “EXT-4 terminal” on page 38 for more information on these types of signals.

Super DigiPure

The Super DigiPure function uses the latest in digital technology to give you a natural-looking picture. The Super DigiPure function includes the following two functions.

DigiPure function:

This function helps to create a natural-looking picture by eliminating unnecessary edges from high-contrast and crisp images. For images with low-contrast, edges are added to produce a sharper, more detailed picture.

You can choose from the three DigiPure function settings of AUTO, MIN and MAX.

- If you set the DigiPure effect too high on a low-quality picture that contains a lot of noise, this may actually make the noise worse. We recommend you use the AUTO setting if you can.

Picture motion compensation function:

This function displays fast-moving pictures (for example, the players or ball in a football game) more smoothly and naturally on the screen.

- The effect level of the picture motion compensation function cannot be changed. The effect level is the same no matter which of the AUTO, MIN or MAX settings is used.

1 Choose Super DigiPure

2 Press the ◀/▶ buttons to choose a setting. Then press the OK button

AUTO:

The TV will automatically adjust the level of the DigiPure effect to match the amount of noise in the picture, giving the best possible picture.

- AUTO cannot be chosen when you are watching the EXT-4 picture.

MIN:

The level of DigiPure effect is set to the minimum. When you set the Super DigiPure function to AUTO and notice some noise, change the setting from AUTO to MIN.

- The MIN setting is not suitable for high-quality pictures which contain very little noise.

MAX:

The level of DigiPure effect is set to the maximum. If you set the Super DigiPure function to AUTO but feel that the original picture quality has not been reproduced fully, change the setting from AUTO to MAX.

- The MAX setting is not suitable for low-quality pictures which contain a lot of noise.

OFF:

The Super DigiPure function is turned off.

COLOUR SYSTEM

The colour system is chosen automatically. However, if the picture is not clear or no colour appears, choose the colour system manually.

1 Choose COLOUR SYSTEM. Then press the OK button

The sub-menu of the COLOUR SYSTEM function appears.

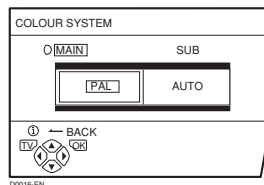

2 Press the ◀/▶ buttons to choose MAIN or SUB MAIN:

You can change the colour system of the main-picture.

SUB:

You can change the colour system of the sub-picture.

- Choose MAIN when a sub-picture is not displayed.

3 Press the ▼/▲ buttons to choose the appropriate colour system. Then press the OK button

PAL:

PAL system

SECAM:

SECAM system

NTSC 3.58:

NTSC 3.58 MHz system

NTSC 4.43:

NTSC 4.43 MHz system

AUTO:

This function detects a colour system from the input signal. You can only use this when you are viewing a picture from programme number PR 0 (AV), or an EXT terminal.

- The AUTO function may not function properly if you have poor signal quality. If the picture is abnormal in the AUTO function, choose another colour system manually.
- When in the programme numbers PR 0 (AV) to PR 99, you cannot choose NTSC 3.58 or NTSC 4.43. SECAM cannot be chosen when the COUNTRY setting is UNITED KINGDOM.

MOVIE THEATRE

The MOVIE THEATRE function displays a cinema film picture more smoothly and naturally on the screen.

AUTO:

The television automatically recognizes the type of signal and turns the function on and off.

ON:

This function is turned on.

OFF:

This function is turned off.

- The motion may appear unnatural when viewing images with the NTSC colour system. When the MOVIE THEATRE function is set to AUTO or ON, the motion may appear unnatural when viewing images with the NTSC colour system.
- You cannot select this function in the twin pictures mode or the picture in picture mode.

4:3 AUTO ASPECT

You can choose one of three ZOOM modes, REGULAR, PANORAMIC or 14:9 ZOOM, as the ZOOM mode for the normal picture (4:3 aspect ratio).

1 Choose 4:3 AUTO ASPECT then press the OK button

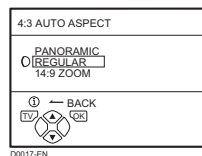

2 Press the ▼/▲ buttons to choose a ZOOM mode. Then press the OK button

COLOUR MANAGEMENT

This TV supports the COLOUR MANAGEMENT function to ensure dull colours are compensated to produce natural hues.

The COLOUR MANAGEMENT function is on by default.

ON:

COLOUR MANAGEMENT function is turned on.

OFF:

COLOUR MANAGEMENT function is turned off.

- Set this function to ON under normal conditions.

PIP (picture-in-picture)

You can choose one of four positions for the sub-picture.

1 Press the ▼/▲ buttons to choose PIP. Then press the OK button

The PIP menu appears.

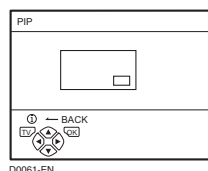

2 Press the ◀/▶ buttons to choose the position. Then press the OK button

SOUND SETTING

Refer to “Using the TV’s menu” (see page 17) for details of displaying the menu.

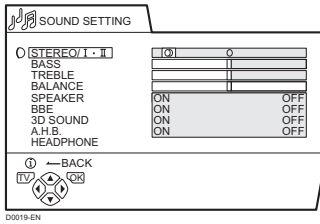

STEREO / I • II

When you are viewing a bilingual broadcast programme, you can choose the sound from Bilingual I (Sub I) or Bilingual II (Sub II). If you have poor reception on a stereo broadcast, you can change from stereo to mono sound so that you can hear the broadcast more clearly and easily.

∞ : Stereo sound

○ : mono sound

I : Bilingual I (sub I)

II : Bilingual II (sub II)

- The sound mode you can choose differs depending on the TV programme.
- This function does not work in the EXT modes. And this function does not appear in the SOUND SETTING menu.

Sound Adjustment

You can adjust the sound to your liking.

BASS:

You can adjust the low tone of the sound.

◀ : weaker

▶ : strong

TREBLE:

You can adjust the high tone of the sound.

◀ : weaker

▶ : strong

BALANCE:

You can adjust the volume balance between the left and right speaker.

◀ : turn the left speaker's volume level up.

▶ : turn the right speaker's volume level up.

SPEAKER

You can turn off the sound from the TV speakers; but you should only do this if an audio system is connected to the TV as a substitute for the TV speakers.

ON:

The TV speakers issue sound.

OFF:

The TV speakers does not issue sound.

BBE

You can use the BBE function to enjoy easy-to-listen sound that is faithful to the original sound recorded.

ON:

This function is turned on.

OFF:

This function is turned off.

- Licensed by BBE Sound, Inc. BBE is a registered trademark of BBE Sound, Inc.

3D SOUND

You can enjoy Surround sound with a “live” effect by using the 3D SOUND function.

ON:

3D SOUND function is turned on.

OFF:

3D SOUND function is turned off.

A.H.B. (Active Hyper Bass)

Used when you want to emphasize the bass sound.

ON:

This function is turned on.

OFF:

This function is turned off.

HEADPHONE

You need to use the HEADPHONE menu to adjust the volume of the headphones.

The HEADPHONE menu can also be used to set whether or not sound comes from the TV speakers when the headphones are being used and to perform the settings for the sound coming from the headphones.

1 Press the ▼/▲ buttons to choose HEADPHONE. Then press the OK button

The sub-menu of the HEADPHONE function appears.

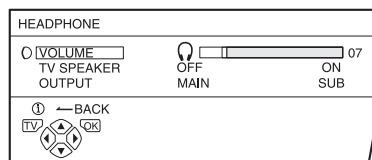

2 Press the ▼/▲ buttons to choose a function. Then press the ◀/▶ buttons to change the setting

VOLUME:

You can change the volume of the headphones.

TV SPEAKER:

You can turn the TV's speakers on or off.

ON:

The sound comes from the TV's speakers when using the headphones.

OFF:

The sound does not come from the TV's speakers when using the headphones.

OUTPUT:

You can choose the sound output to the headphones.

MAIN:

You can listen to the sound of the main-picture with your headphones.

SUB:

You can listen to the sound of the sub-picture with your headphones.

- When the sub-picture is a television programme, the sound becomes monaural.

3 Press the OK button

Hint:

When a sub-picture is displayed, the sound of the sub-picture can be listened to with the headphones while listening to the sound of the main-picture with the TV speakers. To do this, set TV SPEAKER to ON and OUTPUT to SUB.

- Headphones do not work with sound adjusted for BASS and TREBLE, BBE effect sound, A.H.B. effect sound, and 3D SOUND effect sound.
-

EXT SETTING

Refer to “Using the TV’s menu” (see page 17) for details of displaying the menu.

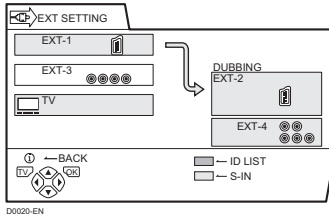

S-IN (S-VIDEO input)

You can connect a device (such as an S-VHS VCR) to enjoy the high-quality picture of the S-VIDEO signal (Y/C signal).

Preparation:

- First read the device’s instruction manual and “Additional preparation” on page 33 to connect the device to the TV properly. Second, follow the device’s instruction manual to set the device so that it sends an S-VIDEO signal (Y/C signal) to the TV.
- Do not set S-IN (S-VIDEO input) to the EXT terminal connected to a device which cannot output an S-VIDEO (Y/C signal). If it is set wrongly, a picture cannot appear.

1 Choose an EXT terminal

2 Press the yellow button and set the S-IN (S-VIDEO input).

Then press the OK button

An S-IN (S-VIDEO input) mark is displayed. You can view an S-VIDEO signal (Y/C signal) instead of the regular video signal (composite signal).

To cancel the S-IN (S-VIDEO input) setting:

Press the yellow button and turn off S-IN (S-VIDEO input) mark. The regular video signal (composite signal) pictures are resumed.

- The EXT-1 terminal does not support S-VIDEO signal (Y/C signal) and you cannot set S-IN (S-VIDEO input) in the EXT-1 terminal.
- Setting S-IN (S-VIDEO input) changes the head character from “E” to “S”. When an EXT terminal receives a normal video signal, “E2” or “E3” appears on the display. This changes to “S2” or “S3” when it receives an S-VIDEO signal.
- Even a device which can output an S-VIDEO signal (Y/C signal) may output a regular video signal (composite signal) depending on the device setting. If a picture cannot appear because the S-IN (S-VIDEO input) setting has been made, read the device instruction manual carefully again to check for the device settings.

ID LIST

You can have a name corresponding to the devices connected for each EXT terminal. Giving a name to an EXT terminal makes the EXT terminal number appear on the screen, together with the name.

1 Choose an EXT terminal

2 Press the blue button to display the name list (ID LIST)

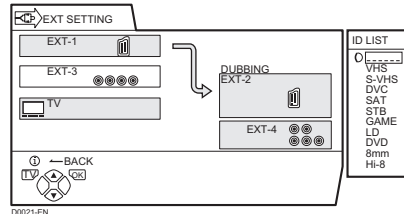

3 Press the ▼/▲ buttons to choose a name. Then press the OK button

The ID LIST disappears and the name is assigned to the EXT terminal.

- You cannot assign an EXT terminal name not found in the name list (ID LIST).

To erase a name assigned to the EXT terminal:
Choose a blank space.

4 Press the OK button to complete the setting

DUBBING

You can choose a signal source to be output from the EXT-2 terminal.

You can do this with the output signals of the devices connected to other EXT terminals, or with the picture and sound from a TV channel you are currently viewing.

1 Press the ◀/▶ buttons to choose the arrow from the menu

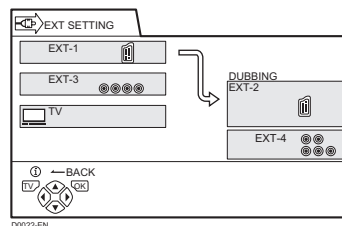

2 Press the ▼/▲ buttons to choose an EXT terminal or TV.

Then press the OK button

The arrow in the menu represents a signal flow. The left side of the arrow shows a signal source output from the EXT-2 terminal.

EXT-1/EXT-3:

The output signal of the device connected to an EXT terminal passes through the TV and is output from the EXT-2 terminal.

TV:

The picture and sound of the TV channel you are currently viewing are output from the EXT-2 terminal.

-
- During dubbing, you cannot turn off the TV. Turning off the TV also turns off the output from the EXT-2 terminal.
 - When you choose an EXT terminal as an output, you can view a TV programme or a picture from the other EXT terminal while dubbing the picture from a device connected to the EXT terminal onto a VCR connected to the EXT-2 terminal.
 - The RGB signals from the TV games cannot be output. Teletext programmes cannot be output.
-

FEATURES

Refer to “Using the TV’s menu” (see page 17) for details of displaying the menu.

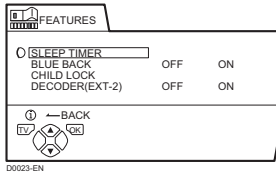

SLEEP TIMER

You can set the TV to automatically turn off after a specified period of time.

1 Choose SLEEP TIMER, then press the OK button

A Sub-menu of the SLEEP TIMER function appears.

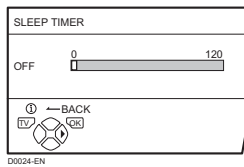

2 Press the ◀/▶ buttons to set the period of time. Then press the OK button

You can set the period of time up to a maximum of 120 minutes (2 hours) in 10 minute steps.

- One minute before the SLEEP TIMER function turns off the TV, “GOOD NIGHT!” appears.
- The SLEEP TIMER function cannot be used to turn off the TV’s main power.
- When the SLEEP TIMER function is on, you can display the sub-menu of the SLEEP TIMER function again to confirm or change the remaining period of time of the SLEEP TIMER function. Press the OK button to leave the menu after confirming or changing the remaining time.

To cancel the SLEEP TIMER function:

Press the ◀ button to set a period of time to “OFF”.

BLUE BACK

You can set the TV to automatically change to a blue screen and mute the sound if the signal is weak or absent, or when there is no input from an external device.

ON:

This function is turned on.

OFF:

This function is turned off.

CHILD LOCK

When there is a TV channel you do not want your children to watch, you can use the CHILD LOCK function to lock out the TV channel. Even when a child chooses a programme number (PR) for a locked TV channel the screen will change to blue and display  (CHILD LOCK) so the TV channel cannot be viewed. Unless you enter a pre-set ID number by a special operation, the lock cannot be released and the child cannot view the TV channel.

To set the CHILD LOCK function

1 Choose CHILD LOCK, then press the 0 (AV) button

“SET ID NO.” (ID number setting screen) appears.

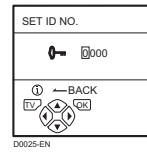

2 Set the ID number to your liking

- 1 Press the ▼/▲ buttons to choose a number.
- 2 Press the ◀/▶ buttons to move the cursor.

3 Press the OK button

The Sub-menu of CHILD LOCK appears.

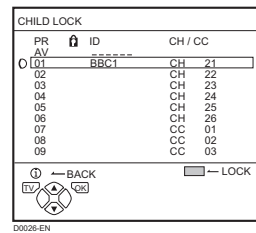

4 Press the ▼/▲ buttons to choose a TV channel

Every time you press the ▼/▲ buttons, the Programme number (PR) changes, and the picture of the TV channel registered in the Programme number (PR) is displayed on the screen.

5 Press the blue button and set the CHILD LOCK function.

Then press the OK button

 (CHILD LOCK) appears and the TV channel is locked.

To reset the CHILD LOCK function:

Press the blue button again.

 (CHILD LOCK) disappears.

To disable easy resetting of the CHILD LOCK function, the menu disappears if you choose the CHILD LOCK function and press the OK button.

To view a locked TV channel

1 Choose a programme number (PR) of a locked TV channel with the number buttons or PR LIST

The screen changes to blue and the  (CHILD LOCK) appears. You cannot view the TV channel.

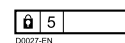

2 Press the (information) button to display “ID NO.” (ID No. input screen)

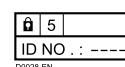

3 Press the Number buttons to enter the ID number

The lock is temporarily released so you can view the TV channel.

If you have forgotten the ID number:

Perform step 1 of “To set the CHILD LOCK function”. After confirming the ID number, press the **TV** button to exit the menu.

-
- Even if you reset the lock temporarily, it does not mean that the CHILD LOCK function set for the TV channel is cancelled. The next time anyone tries to view the TV channel, it will be locked again.
 - When you want to cancel the CHILD LOCK function, you must perform the operation “To set the CHILD LOCK function” again.
 - To stop it being easy to choose the programme number (PR) of a locked TV channel, the programme number (PR) has been set so that it cannot be chosen with the ▼/▲ buttons or the buttons of the TV.
 - To stop it being easy to reset the lock, “ID NO.” (ID No. input screen) is set so that it cannot appear unless you press the ⓘ (information) button.
-

DECODER (EXT-2)

You can only use this function if you have a decoder connected to a T-V LINK compatible VCR, which in turn is connected to the EXT-2 terminal. To use this function, see “Using the DECODER (EXT-2) function” on page 32.

Caution

- If you have not connected a decoder with a T-V LINK compatible VCR to the EXT-2 terminal, setting this function to “ON” by mistake causes the picture/sound of a TV channel you are currently viewing to disappear.

INSTALL

Refer to “Using the TV’s menu” (see page 17) for details of displaying the menu.

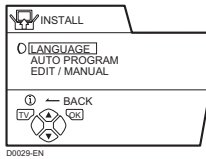

LANGUAGE

You can choose the language you want to use for the on-screen display from the language list in a menu.

1 Choose LANGUAGE, then press the OK button

A sub-menu of the LANGUAGE function appears.



2 Press the ◀/▶ and ▼/▲ buttons to choose a language. Then press the OK button

AUTO PROGRAM

You can automatically store the TV channels for which you have the best reception. Store them in the TV’s programme numbers (PR) list by doing the following.

For users in the UK:

To receive SKY 1 you need a satellite tuner. You must have the satellite tuner set to SKY 1 before starting the AUTO PROGRAM function.

1 Choose AUTO PROGRAM. Then press the OK button

The COUNTRY menu appears as a sub-menu of the AUTO PROGRAM function.

There are two COUNTRY menus. Pressing the yellow button changes the COUNTRY menu as follows:

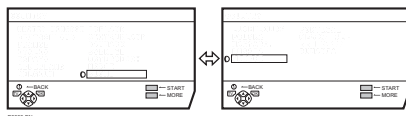

2 Press the ◀/▶ and ▼/▲ buttons to choose the country where you are now located

3 Press the blue button to start the AUTO PROGRAM function

The AUTO PROGRAM menu appears and the TV channels you receive are automatically registered in the programme numbers (PR) list.

- To cancel the AUTO PROGRAM function, press the TV button.

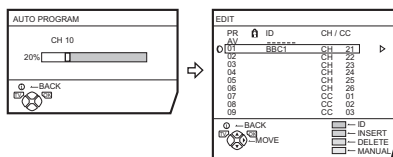

After the TV channels have been registered in the programme numbers (PR), the EDIT menu appears.

- You can now edit the programme numbers (PR) using the EDIT/MANUAL function. For details, see “EDIT/MANUAL” on page 28.
- If you do not need to use the EDIT/MANUAL function, go to the next step.

If “ACI START/ACI SKIP” appears in the AUTO PROGRAM menu:

You can use the ACI (Automatic Channel Installation) function to decode the ACI data and complete the registration of all the TV channels quickly. For details of the ACI function and how to use it, refer to “Using the ACI function” on page 31.

If you don’t want to use the ACI function, press the ▼/▲ buttons to choose ACI SKIP and then press OK.

4 Press the OK button to display the T-V LINK menu

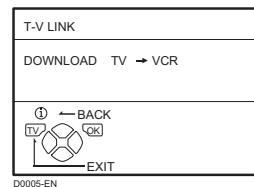

5 If you do not have a T-V LINK compatible VCR connected:

Press the TV button to leave the T-V LINK menu. The T-V LINK menu disappears and all the settings are completed.

If you have a T-V LINK compatible VCR connected to the EXT-2 terminal:

See “Downloading data to a VCR” on page 31 to transmit the programme number (PR) data to the VCR.

- If a TV channel you want to view is not set to a programme number (PR), set it manually using the MANUAL function. For details, see “EDIT/MANUAL” on page 28.
- The AUTO PROGRAM function does not set the programme number PR 0 (AV) for your video cassette recorder. You will need to set this using the manual function.
- In some areas you may get TV reception from more than one transmitter, for example, different ITV regions. In this case each TV channel could be set twice. If this happens, the first set of channels will have the stronger signal. If you want to delete the second set of channels, you will have to do it manually (see page 30).

EDIT/MANUAL

The EDIT/MANUAL functions are divided into two types:

- editing the current programme numbers (PR) (EDIT functions); and
- manually storing a TV channel you want to view on a particular programme number (PR) (MANUAL function).

Here are the details about these functions:

Caution

- Using the MOVE, DELETE or INSERT functions rewrites the current programme numbers (PR) list. Therefore, the programme numbers (PR) of some of the TV channels will change.
- Using the MANUAL function for a TV channel for which the CHILD LOCK function has been set cancels the CHILD LOCK function for that channel.
- Using the MANUAL function for a TV channel for which the DECODER (EXT-2) function has been set to ON returns the setting of the DECODER (EXT-2) function for that channel to OFF.
- When a TV channel has already been registered in PR 99, using the INSERT function deletes that TV channel.

1 Choose EDIT/MANUAL, then press the OK button

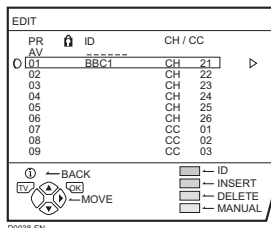

- For programme number PR 0, “AV” appears in the programme numbers (PR) list.
- An EXT terminal number does not appear in the programme numbers (PR) list.
- The CH/CC number is a number unique to the TV and corresponds to the channel number of a TV channel. For the relationship between a channel number and a CH/CC number, see “CH/CC numbers” on page 35.

2 Follow the operation description of a function you want to use and operate the function

MOVE:

This function changes a programme number (PR) of a TV channel.

ID:

This function registers a channel name (ID) to a TV channel.

INSERT:

This function adds a new TV channel in the current programme numbers (PR) list by using the CH/CC number.

- You cannot use the INSERT function if you do not know a channel number of a TV channel. Use the MANUAL function to register a TV channel in the programme number (PR).

DELETE:

This function deletes a TV channel you do not want to list.

MANUAL:

This function manually stores a new TV channel in a programme number (PR).

3 Press the OK button to complete the settings

The T-V LINK menu appears.

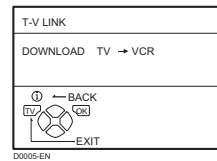

4 If you do not have a T-V LINK compatible VCR connected:

Press the TV button to exit the T-V LINK menu.

The T-V LINK menu disappears and all the settings are completed.

If you have a T-V LINK compatible VCR connected to the EXT-2 terminal:

Follow the operating procedure “Downloading data to a VCR” on page 31 to transmit the Programme number (PR) data to the VCR.

MOVE

1 Press the ▼/▲ buttons to choose a TV channel

Every time you press the ▼/▲ buttons, the programme number (PR) changes and the picture of the TV channel stored in the programme number (PR) appears on the screen.

2 Press the ► button to start the MOVE function

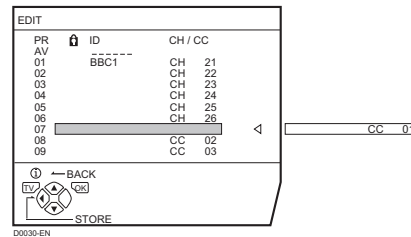

3 Press the ▼/▲ buttons to choose a new programme number (PR)

To cancel the MOVE function:

Press the ⓘ (information) button.

4 Press the ◀ button to change the programme number (PR) of a TV channel to a new programme number (PR)

■ ID

1 Press the ▼/▲ buttons to choose a TV channel

Every time you press the ▼/▲ buttons, the programme number (PR) changes and the picture of the TV channel stored in the programme number (PR) appears on the screen.

2 Press the red button to start the ID function

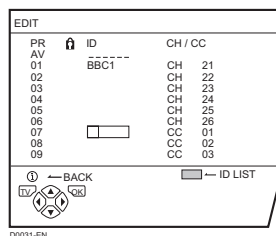

3 Press the ▼/▲ buttons to choose the first character of a channel name (ID) you want to give to the TV channel

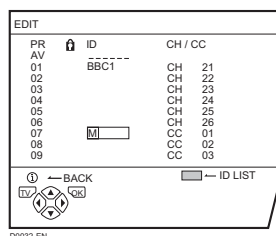

4 Press the blue button to display the ID LIST (channel name list)

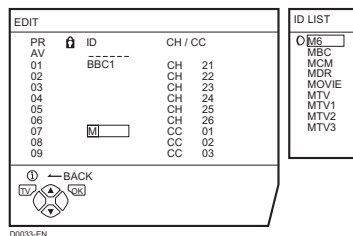

5 Press the ▼/▲ buttons to choose the channel name (ID)

To cancel the ID function:
Press the (i) (information) button.

6 Press the OK button to give a channel name (ID) to a TV channel

- You can give your own unique channel name (ID) to the TV channel. When you have finished step 3, do not go to step 4. Press the ◀/▶ buttons to move the cursor, and press the ▼/▲ buttons to choose each character of the channel name (ID). Then press the OK button to register the channel name (ID) to the TV channel.

■ INSERT

Preparation:

- A CH/CC number unique to this TV and corresponding to the Channel number of a TV channel is required. Find the corresponding CH/CC number from a table “CH/CC numbers” on page 35 based on the Channel number of the TV channel.
- When the COUNTRY setting is not FRANCE, use a two-digit CH/CC number. When the COUNTRY setting is FRANCE, use a three-digit CH/CC number.
- Only when you add a TV channel (SECAM-L system) from a French station, be sure to set COUNTRY to FRANCE. If the COUNTRY setting is not FRANCE, follow the description “Changing the COUNTRY setting” on page 32 to change the COUNTRY setting to FRANCE, then start the INSERT function.

1 Press the ▼/▲ buttons to choose a programme number (PR) for which you will register a new TV channel

2 Press the green button and start the INSERT function

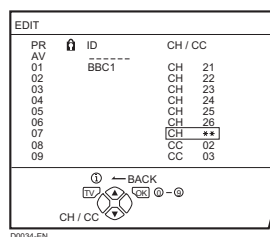

To cancel the INSERT function:
Press the (i) (information) button.

3 When the COUNTRY setting is UNITED KINGDOM:

Press the number buttons to enter the remaining CH number

- You cannot enter CC numbers.

When the COUNTRY setting is not UNITED KINGDOM:

Press the ▼/▲ buttons to choose “CH” or “CC”, then press the number buttons to enter the remaining CH or CC number

When the COUNTRY setting is FRANCE:

Choose “CH1”, “CH2”, “CC1” or “CC2”.

The TV shifts to registration mode.

When the registration is completed, the picture of the TV channel appears on the screen.

- The CH/CC number is a number given to each broadcast frequency that carries a TV channel. If the TV cannot detect the TV channel corresponding to the broadcast frequency indicated by the CH/CC number, a “no-signal” picture appears.

■ **DELETE**

1 Press the ▼/▲ buttons to choose a TV channel

Every time you press the ▼/▲ buttons, the programme number (PR) changes and the picture of the TV channel stored in the programme number (PR) appears on the screen.

2 Press the yellow button to delete the TV channel

The TV channel is deleted from the programme numbers (PR) list.

■ **MANUAL**

Preparation:

- If you register a TV channel (SECAM-L system) from a French station, be sure to set the COUNTRY setting to FRANCE. If the COUNTRY setting is not FRANCE, follow the description “Changing the COUNTRY setting” on page 32 to change the COUNTRY setting to FRANCE, then start the MANUAL function.

1 Press the ▼/▲ buttons to choose a Programme number (PR) to which you want to register a new TV channel

2 Press the blue button to activate the MANUAL function

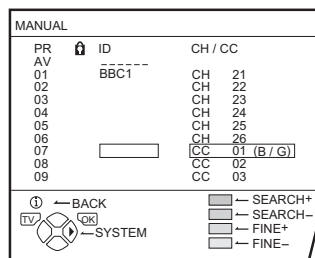

To cancel the MANUAL function:

Press the ⓘ (information) button.

When the COUNTRY setting is not UNITED KINGDOM:

At the right side following the CH/CC number, the SYSTEM (broadcasting system) of the TV channel appears.

3 When the COUNTRY setting is UNITED KINGDOM:

Continue to step 4

When the COUNTRY setting is not UNITED KINGDOM:

Press the ► button to choose the SYSTEM (broadcasting system) for a TV channel you want to register

TV channel (SECAM-L system) from a French station:

Set the SYSTEM to “L”. If it is set to one other than “L”, you cannot receive the TV channel of the SECAM-L system.

Other TV channels:

If you do not know the correct broadcasting system, set the SYSTEM to “B/G”. If “B/G” is not correct, it results in the fact that you will not hear the sound normally when the TV detects a TV channel. In this case, retry to set the SYSTEM again correctly so that no problem arises.

4 Press the green or red button to search for a TV channel

Scanning stops when the TV finds a TV channel. Then the TV channel is displayed.

5 Press the green or red button repeatedly until the TV channel you want appears

If the TV channel reception is poor:

Press the blue or yellow button to fine-tune the TV channel.

If you cannot hear the normal sound even when the picture of the TV channel appears normally:

The SYSTEM setting is wrong. Press the ► button and choose a SYSTEM that has normal sound.

6 Press the OK button and register the TV channel to a programme number (PR)

The normal EDIT menu is resumed.

Additional menu operations

Using the ACI function

This TV has an ACI function which decodes the ACI (Automatic Channel Installation) data.

Using the ACI function allows all TV channels transmitted from the cable TV station to be properly registered quickly according to the data from the cable TV station.

Caution

- If your cable TV station broadcasts ACI data and if “ACI START/ACI SKIP” appears in the AUTO PROGRAM menu, the ACI function is enabled. In all other cases, it is disabled.

- 1 Press the ▼/▲ buttons to choose ACI START. Then press the OK button to start the ACI function

When you don't want to use the ACI function:

Press the ▼/▲ buttons to choose ACI SKIP and then press the OK button.

If the AUTO PROGRAM menu changes to another menu:

Depending on your cable TV station, there may be a broadcast selection menu set up by the cable TV station. Follow the menu and use the ◀/▶ and ▼/▲ buttons. After you have made the setting, press the OK button.

If “ACI ERROR” is displayed in the AUTO PROGRAM menu:

“ACI ERROR” means that the ACI function is not working properly. Press the OK button to start the ACI function again.

If “ACI ERROR” still appears even after you have tried to start the ACI function several times, press the ▶ button to start the AUTO PROGRAM function. It does not cause any problem because all the TV channels are registered to the Programme numbers (PR) by the AUTO PROGRAM function.

- 2 When the settings are completed, the EDIT menu is displayed. Return to the instructions that you were reading before, and continue the operation

When the “Initial settings” have been made:

Return to step 6 of “Initial settings” on page 8.

When the “AUTO PROGRAM” has finished:

Return to step 4 of “AUTO PROGRAM” on page 27.

- If you have any questions about the items in the Broadcast Selection menu or how to operate the menu, please contact your cable TV station.
- When the cable TV broadcast reception is poor, the ACI function will not work properly.
- If there is an error in the ACI data itself, the TV channel cannot be registered properly. If this happens, turn the ACI function off (ACI SKIP) and use the AUTO PROGRAM function. Or, use the EDIT/MANUAL function to correct the programme number (PR) setting.

Downloading data to a VCR

You can send the latest programme numbers (PR) data to a VCR with the T-V LINK function.

- You can only do this when a T-V LINK compatible VCR is connected to the EXT-2 terminal.
- This only works when the T-V LINK menu is being displayed.

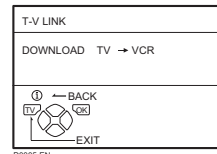

- 1 Turn on the VCR

- 2 Press the OK button

The data transmission begins.

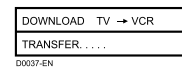

The T-V LINK menu disappears once the data transmission ends.

When the T-V LINK menu changes over to another menu:

The TV has finished its menu. This new menu is operated from the VCR. See the VCR instruction manual for what to do next.

If “FEATURE NOT AVAILABLE” appears at the T-V LINK menu, check the following three items.

- Has a T-V LINK compatible VCR been connected to the EXT-2 terminal?
- Has the VCR power been turned on?
- Does the SCART cable that connects the EXT-2 terminal to the T-V LINK compatible VCR have all its proper connections?

Then press the OK button to retry data transmission.

Changing the COUNTRY setting

After the AUTO PROGRAM function is completed, you can change the country you have already set by using the AUTO PROGRAM function.

When registering the TV channels for French broadcast stations (SECAM-L system), perform this operation to change the country.

1 Display the INSTALL menu

When the EDIT menu is currently being displayed:

Press the **i** (information) to return to the INSTALL menu.

2 Press the ▼/▲ buttons to choose AUTO PROGRAM. Then press the OK button

A COUNTRY menu appears as a sub-menu of the AUTO PROGRAM function.

There are two COUNTRY menus. Pressing the yellow button changes the COUNTRY as follows:

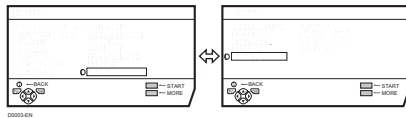

3 Press the ◀/▶ and the ▼/▲ buttons to choose a country

4 Press the OK button to complete the setting

The menu disappears.

To return to the INSTALL menu from the COUNTRY menu:

Press the **i** (information) button instead of the **OK** button.

Using the DECODER (EXT-2) function

If you have a decoder connected to a T-V LINK compatible VCR, which in turn is connected to the EXT-2 terminal, use the DECODER (EXT-2) function to unscramble the scrambled TV channels.

1 Turn on the decoder power

2 Display the scrambled TV channel on the TV

Even if the decoder is working, a scrambled picture appears.

3 Press the OK button to display the MENU

The MENU (main menu) appears.

4 Press the ▼/▲ buttons to choose FEATURES. Then press the OK button

The FEATURES menu appears.

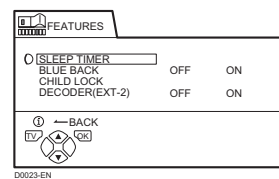

5 Press the ▼/▲ buttons to choose DECODER (EXT-2). Then press the ◀/▶ buttons to choose ON

An unscrambled picture appears.

To cancel the DECODER (EXT-2) function:

Press the ◀/▶ buttons to choose OFF.

6 Press the OK button to complete the setting

The T-V LINK menu appears.

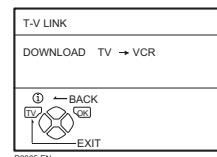

7 Follow “Downloading data to a VCR” on page 31 to transmit the programme number (PR) data to the VCR

8 If you have another TV channel you want to unscramble using a decoder, repeat steps 2 to 7

If the DECODER (EXT-2) function has been set to “ON” but the TV channel cannot be unscrambled, check the following:

- Has the decoder been connected to the VCR properly according to the VCR and decoder instruction manuals?
- Has the decoder power been turned on?
- Can the TV channel be unscrambled with a decoder?
- Do you need to change the VCR settings in order to connect the decoder? Confirm that the VCR is set properly by rechecking the VCR Instruction manual.

Additional preparation

Connecting external equipment

Connect the equipment to the TV, making the correct rear panel and front panel connections.

Before connecting anything:

- Read the manuals that came with the equipment.
Depending on the equipment, the connection method may be different from the diagram. Also, the equipment settings may need to change depending on the connection method.
- Turn off all the equipment including the TV.
- The “Specifications” on page 38 give the details of the EXT terminals. If you are connecting equipment not listed in the following connection diagram, see the table to choose the best EXT terminal.
- Connecting cables are not supplied.

- ① VCR (composite signal)
- ② VCR (composite signal/S-VIDEO signal)
- ③ T-V LINK compatible VCR (composite signal/S-VIDEO signal)
- ④ Decoder
- ⑤ DVD player (composite signal/S-VIDEO signal)
- ⑥ DVD player (composite signal/RGB signal)
- ⑦ DVD player (component video signals; Pr/Pb/Y)
- ⑧ TV game (composite signal/RGB signal)
- ⑨ TV game (composite signal/S-VIDEO signal)
- ⑩ Headphones
- ⑪ Camcorder (composite signal/S-VIDEO signal)
- ⑫ SCART cable
- ⑬ Audio cable
- ⑭ Video cable
- ⑮ S-VIDEO cable
- ⑯ Component cable

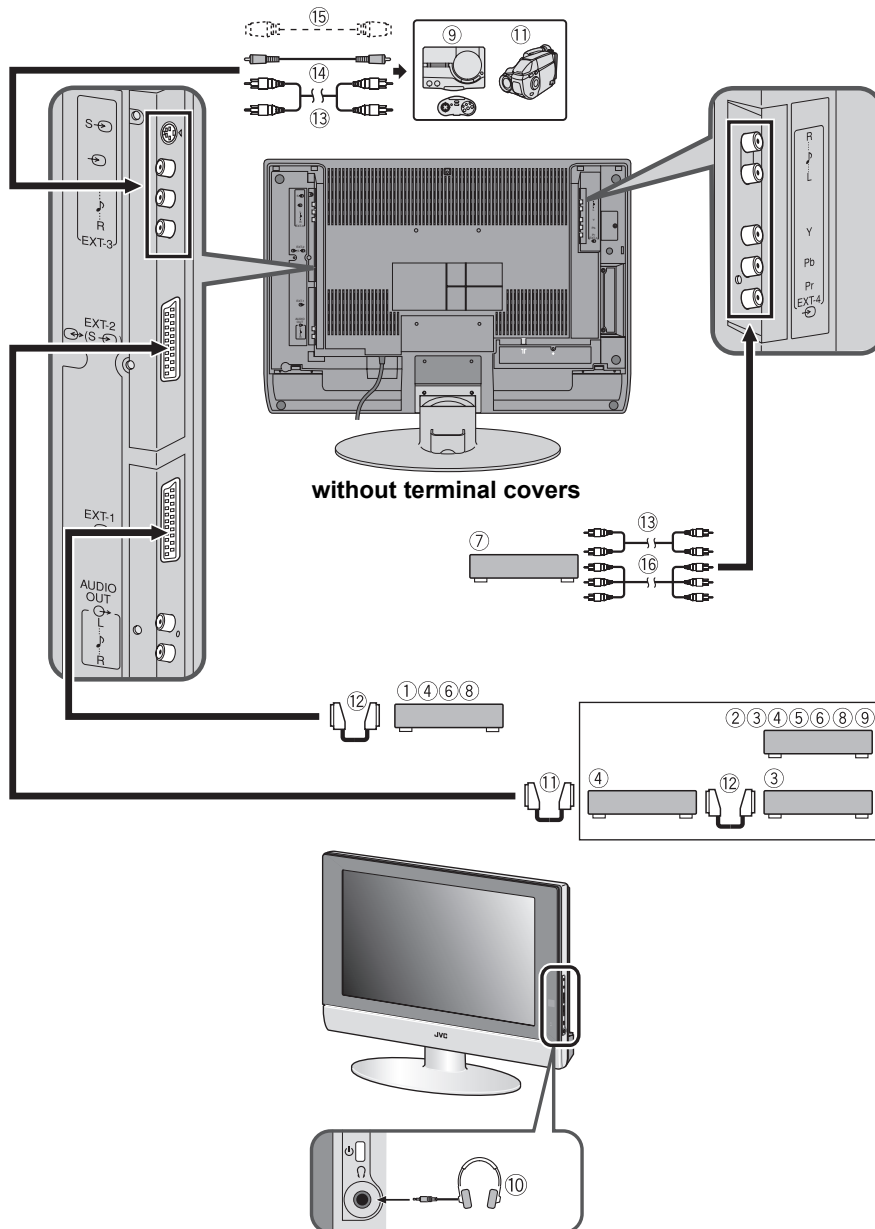

■ **Equipment which can output the S-VIDEO signal (Y/C signal) such as an S-VHS VCR**

Connect the equipment to an EXT terminal (but not the EXT-1 terminal).

You can choose between an S-VIDEO signal (Y/C signal) and a regular video signal (composite signal). For details of how to operate the equipment, see “S-IN (S-VIDEO input)” on page 23.

■ **T-V LINK compatible VCR**

Be sure to connect the T-V LINK compatible VCR to the EXT-2 terminal. If not, the T-V LINK function will not work properly.

- When connecting a T-V LINK compatible VCR to the EXT-2 terminal, be sure to connect the decoder to the VCR. If not, the T-V LINK function may not work properly. After you have stored TV channels in the programme numbers (PR) list, set the DECODER (EXT-2) function for the programme number (PR) to ON to unscramble a scrambled TV channel. For details, see “Using the DECODER (EXT-2) function” on page 32.

■ **Connecting headphones**

Connect the headphones with a stereo mini-jack (3.5 mm diameter) to the headphone socket at the TV.

- The headphone volume is adjusted with the “HEADPHONE” menu (see page 22).

■ **Video or sound signal output from the EXT-2 terminal**

You can change over the output of the video/sound signal from the EXT-2 terminal. This is useful when you want to dub the video/sound from another device onto the VCR connected to the EXT-2 terminal. For details on how to do this, see “DUBBING” on page 23.

■ **TV output from the EXT-1 terminal**

The video/sound signal of a TV channel you are viewing is always output from the EXT-1 terminal.

- Changing over a programme number (PR) also changes over the TV output from the EXT-1 terminal.
- The video/sound signal from an EXT terminal cannot be output.
- Teletext programmes cannot be output.

■ **Connecting Speakers/Amplifier**

See the Audio equipment connection diagram, then connect the audio equipment you desire to the TV.

You can use external front speakers to listen to the TV sound instead of the TV speakers.

Before connecting anything:

- Read the manuals provided with the amplifier and speakers.
- Turn the TV and amplifier off.
- To prevent magnetism from the speakers adversely affecting the TV screen, use magnetically-shielded speakers for the front speakers.
- Note that connecting cables are not supplied.

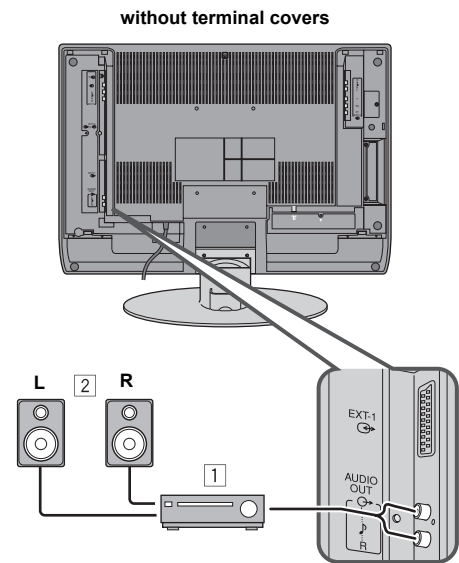

- 1 Amplifier
- 2 External speakers (Magnetic-shielded type)

- The output from the AUDIO OUT terminal is not interrupted by headphone connection to the TV. You cannot cut the sound from the front speaker even if you connect a headphone to the TV.
- Adjust the volume of the external speakers with the amplifier.

CH/CC numbers

When you want to use the INSERT function on page 29, find the CH/CC number corresponding to the Channel number of the TV channel from this table.

CH	Channel	CH	Channel	CC	Channel	CC	Channel
CH 02 / CH 202	E2, R1	CH 40 / CH 240	E40, R40	CC 01 / CC 201	S1	CC 31 / CC 231	S31
CH 03 / CH 203	E3, ITALY A	CH 41 / CH 241	E41, R41	CC 02 / CC 202	S2	CC 32 / CC 232	S32
CH 04 / CH 204	E4, ITALY B, R2	CH 42 / CH 242	E42, R42	CC 03 / CC 203	S3	CC 33 / CC 233	S33
CH 05 / CH 205	E5, ITALY D, R6	CH 43 / CH 243	E43, R43	CC 04 / CC 204	S4	CC 34 / CC 234	S34
CH 06 / CH 206	E6, ITALY E, R7	CH 44 / CH 244	E44, R44	CC 05 / CC 205	S5	CC 35 / CC 235	S35
CH 07 / CH 207	E7, ITALY F, R8	CH 45 / CH 245	E45, R45	CC 06 / CC 206	S6	CC 36 / CC 236	S36
CH 08 / CH 208	E8, R9	CH 46 / CH 246	E46, R46	CC 07 / CC 207	S7	CC 37 / CC 237	S37
CH 09 / CH 209	E9, ITALY G	CH 47 / CH 247	E47, R47	CC 08 / CC 208	S8	CC 38 / CC 238	S38
CH 10 / CH 210	E10, ITALY H, R10	CH 48 / CH 248	E48, R48	CC 09 / CC 209	S9	CC 39 / CC 239	S39
CH 11 / CH 211	E11, ITALY H+1, R11	CH 49 / CH 249	E49, R49	CC 10 / CC 210	S10	CC 40 / CC 240	S40
CH 12 / CH 212	E12, ITALY H+2, R12	CH 50 / CH 250	E50, R50	CC 11 / CC 211	S11	CC 41 / CC 241	S41
CH 21 / CH 221	E21, R21	CH 51 / CH 251	E51, R51	CC 12 / CC 212	S12	CC 75 / CC 275	X
CH 22 / CH 222	E22, R22	CH 52 / CH 252	E52, R52	CC 13 / CC 213	S13	CC 76 / CC 276	Y, R3
CH 23 / CH 223	E23, R23	CH 53 / CH 253	E53, R53	CC 14 / CC 214	S14	CC 77 / CC 277	Z, ITALY C, R4
CH 24 / CH 224	E24, R24	CH 54 / CH 254	E54, R54	CC 15 / CC 215	S15	CC 78 / CC 278	Z+1, R5
CH 25 / CH 225	E25, R25	CH 55 / CH 255	E55, R55	CC 16 / CC 216	S16	CC 79 / CC 279	Z+2
CH 26 / CH 226	E26, R26	CH 56 / CH 256	E56, R56	CC 17 / CC 217	S17		
CH 27 / CH 227	E27, R27	CH 57 / CH 257	E57, R57	CC 18 / CC 218	S18		
CH 28 / CH 228	E28, R28	CH 58 / CH 258	E58, R58	CC 19 / CC 219	S19		
CH 29 / CH 229	E29, R29	CH 59 / CH 259	E59, R59	CC 20 / CC 220	S20		
CH 30 / CH 230	E30, R30	CH 60 / CH 260	E60, R60	CC 21 / CC 221	S21		
CH 31 / CH 231	E31, R31	CH 61 / CH 261	E61, R61	CC 22 / CC 222	S22		
CH 32 / CH 232	E32, R32	CH 62 / CH 262	E62, R62	CC 23 / CC 223	S23		
CH 33 / CH 233	E33, R33	CH 63 / CH 263	E63, R63	CC 24 / CC 224	S24		
CH 34 / CH 234	E34, R34	CH 64 / CH 264	E64, R64	CC 25 / CC 225	S25		
CH 35 / CH 235	E35, R35	CH 65 / CH 265	E65, R65	CC 26 / CC 226	S26		
CH 36 / CH 236	E36, R36	CH 66 / CH 266	E66, R66	CC 27 / CC 227	S27		
CH 37 / CH 237	E37, R37	CH 67 / CH 267	E67, R67	CC 28 / CC 228	S28		
CH 38 / CH 238	E38, R38	CH 68 / CH 268	E68, R68	CC 29 / CC 229	S29		
CH 39 / CH 239	E39, R39	CH 69 / CH 269	E69, R69	CC 30 / CC 230	S30		

CH	Channel	CH	Channel	CC	Frequency (MHz)	CC	Frequency (MHz)
CH 102	F2	CH 141	F41	CC 110	116 - 124	CC 152	391 - 399
CH 103	F3	CH 142	F42	CC 111	124 - 132	CC 153	399 - 407
CH 104	F4	CH 143	F43	CC 112	132 - 140	CC 154	407 - 415
CH 105	F5	CH 144	F44	CC 113	140 - 148	CC 155	415 - 423
CH 106	F6	CH 145	F45	CC 114	148 - 156	CC 156	423 - 431
CH 107	F7	CH 146	F46	CC 115	156 - 164	CC 157	431 - 439
CH 108	F8	CH 147	F47	CC 116	164 - 172	CC 158	439 - 447
CH 109	F9	CH 148	F48	CC 123	220 - 228	CC 159	447 - 455
CH 110	F10	CH 149	F49	CC 124	228 - 236	CC 160	455 - 463
CH 121	F21	CH 150	F50	CC 125	236 - 244	CC 161	463 - 469
CH 122	F22	CH 151	F51	CC 126	244 - 252		
CH 123	F23	CH 152	F52	CC 127	252 - 260		
CH 124	F24	CH 153	F53	CC 128	260 - 268		
CH 125	F25	CH 154	F54	CC 129	268 - 276		
CH 126	F26	CH 155	F55	CC 130	276 - 284		
CH 127	F27	CH 156	F56	CC 131	284 - 292		
CH 128	F28	CH 157	F57	CC 132	292 - 300		
CH 129	F29	CH 158	F58	CC 133	300 - 306		
CH 130	F30	CH 159	F59	CC 141	306 - 311		
CH 131	F31	CH 160	F60	CC 142	311 - 319		
CH 132	F32	CH 161	F61	CC 143	319 - 327		
CH 133	F33	CH 162	F62	CC 144	327 - 335		
CH 134	F34	CH 163	F63	CC 145	335 - 343		
CH 135	F35	CH 164	F64	CC 146	343 - 351		
CH 136	F36	CH 165	F65	CC 147	351 - 359		
CH 137	F37	CH 166	F66	CC 148	359 - 367		
CH 138	F38	CH 167	F67	CC 149	367 - 375		
CH 139	F39	CH 168	F68	CC 150	375 - 383		
CH 140	F40	CH 169	F69	CC 151	383 - 391		

- When two CH/CC numbers correspond to one Channel number, choose either one according to the current COUNTRY setting. When the COUNTRY setting is other than FRANCE, choose a two-digit CH/CC number. When the COUNTRY setting is FRANCE, choose a three-digit CH/CC number.
- Find the CH/CC number (CC110 to CC161) corresponding to the TV channel (SECAM-L system) from a French cable TV station, based on the broadcast frequency of the TV channel. When you do not know the broadcast frequency, please contact the cable TV station.
- The CH/CC numbers of CH102-CH169 and CC110-CC161 correspond to the TV channels being broadcast by a SECAM-L system. The other CH/CC numbers correspond to the TV channels being broadcast by a method other than a SECAM-L system.
- When the COUNTRY setting is UNITED KINGDOM, the TV can receive only channels CH21 to CH69.

Troubleshooting

If a problem arises while you are using the TV, please read this troubleshooting guide carefully before you ask to have the TV repaired. You may be able to fix it easily by yourself. For example, if the mains plug is disconnected from the mains outlet, or the TV aerial has problems, you may think there is a problem with the TV itself.

Important:

- This troubleshooting guide only covers problems whose causes are not easy to decide. If you have a question when you are operating a function, read the page(s) for that function carefully, not this troubleshooting guide.
- If you follow the advice in this troubleshooting guide without any success, unplug the mains plug and ask for your TV to be repaired. Do not attempt to repair the TV by yourself or to remove the rear cover of the TV.

■ If you cannot turn on the TV

- Is the AC plug on the power cord from the TV is connected to an AC outlet?
- Make sure you set the VCR/TV/DVD switch to the TV position. You cannot turn the TV on when the VCR/TV/DVD switch is set to the VCR or DVD position.

■ If you cannot turn off the TV

- Make sure you set the VCR/TV/DVD switch to the TV position. You cannot turn the TV off when the VCR/TV/DVD switch is set to the VCR or DVD position.

■ No picture or no sound

- Have you chosen a TV channel with very poor reception? If so, the BLUE BACK function will be activated: the entire screen becomes blue, and the sound is muted. If you still want to view the TV channel, follow the description “BLUE BACK” on page 25 to change the BLUE BACK function setting to OFF.
- Have you set the SPEAKER function to OFF? Follow the description “SPEAKER” on page 21 to check the SPEAKER function setting.
- If the SYSTEM setting for a TV channel is incorrect, it may prevent the sound from being heard. Follow the description “EDIT/MANUAL” on page 28 to use the MANUAL function to try to change the SYSTEM setting.

■ Poor picture

- If noise (snow) totally blocks out the picture, there may be a problem with the aerial or aerial cable. Check the following to try to solve the problem:
 - Have the TV and aerial been connected properly?
 - Has the aerial cable been damaged?
 - Is the aerial pointing in the right direction?
 - Is the aerial itself faulty?
- If the TV or aerial suffers interference from other equipment, stripes or noise may appear in the picture. Move any equipment such as an amplifier, personal computer, or a hair drier, that can cause interference away from your TV. Or try moving the TV. If the aerial suffers interference from a radio tower or high-voltage wire, please contact your local dealer.
- If the TV suffers interference from signals reflecting from mountains or buildings, double-pictures (ghosting) will occur. Try to change the aerial’s direction or replace it with one with better directionality.
- Are your COLOUR SYSTEM settings correct? Follow the description “COLOUR SYSTEM” on page 20 to try to solve the trouble.
- Have the COLOUR and BRIGHT settings been adjusted properly? Follow the description “Picture Adjustment” on page 18 to try to adjust them properly.
- Videotaping teletext is not recommended because it may not record correctly.
- When viewing images from commercially available video software products, or videos from videotapes which have been recorded improperly, the top of the image may be distorted. This is due to the condition of the video signal. There is nothing wrong with the TV.

■ Poor sound

- Have you adjusted BASS or TREBLE properly? If not, follow the description “Sound Adjustment” on page 21.
- When TV channel reception is poor, it can be hard to hear stereo or bilingual sound. In this case, follow the description “STEREO / I • II” on page 21 to hear the sound more easily by changing it to a mono sound.

■ If the TV does not respond to the remote control

- Have the batteries of the remote control worn out? Follow the description “Putting the batteries into the Remote control” on page 5 and replace them with new batteries.
- Have you attempted to use the remote control from the sides or rear of the TV or from more than seven metres away from the TV? Use the remote control in the front of your TV or from less than seven metres away.
- When you are viewing a teletext programme, you cannot operate the menus. Press the **TV** button to return to the ordinary TV programme, and then try operating the menus.
- If the TV suddenly stops responding, disconnect the power cord of the TV from the AC outlet. Connect them to the AC outlet again to turn on the TV. If the TV returns to a normal state, it is not a failure.

■ Other concerns

- When the SLEEP TIMER function operates, the TV is automatically turned off. If the TV suddenly turns off, try to press the $\odot/|$ (standby) button to turn on the TV once again. If the TV goes back to normal, there is no problem.
- When the TV is receiving a wide-screen signal (WSS) or a signal from an external device affecting the screen size, the ZOOM mode automatically changes. When you want to resume the previous ZOOM mode, press the **ZOOM** button again.
- It takes a short period of time from the time an operation such as changing channels is performed until an image is displayed. This is not a malfunction. This is the time required for the image to stabilize before it can be displayed.
- The TV may make a crackling sound due to a sudden change in temperature. The picture or sound may be normal. If you hear crackling sounds frequently while you are viewing the TV, there may be other causes. As a precaution, ask your service technician to inspect it.
- In the twin pictures mode the sub-picture may disappear when the external device is operated. If this happens, press the \blacksquare button and display the sub-picture again.
- The headphone volume is adjusted with the "HEADPHONE" menu. It cannot be adjusted with the \triangleleft (volume) $-/+$ buttons.
- When TV SPEAKER in the "HEADPHONE" menu is ON, even if the headphones are connected, sound is emitted from the TV speaker. When you do not want to emit sound from the TV speaker, turn the setting OFF.
- The top of the TV and the screen may become hot during use but this has no affect on the performance of the TV. Make sure that the ventilation holes are not blocked.
- When the picture is unstable, the screen may become white for a moment. This happens when the signal which drives the liquid crystal is missing. This is not a fault.
- When a still image has been displayed for a long period, a faint residual image may remain on the screen for a short time after the power has been turned off or when another image is displayed. This is not a fault and the image will eventually disappear.

Specifications

Item	Model	LT-26C31BUE/LT-26C31SUE	LT-26C31BJE/LT-26C31SJE
Broadcasting systems		CCIR B/G, I, D/K, L	
Colour systems		PAL, SECAM • The EXT terminals also support the NTSC 3.58/4.43 MHz system.	
Channels and frequencies		<ul style="list-style-type: none"> • E2-E12, E21-E69, S1-S41, X, Y, Z, Z+1, Z+2, ITALY A-H, ITALY H+1, ITALY H+2, F2-F10, F21-F69, R1-R12, R21-R69, IR A-J • French cable TV channel of broadcast frequencies 116 - 172 MHz and 220 - 469 MHz 	
Sound-multiplex systems		A2 (B/G, D/K), NICAM (B/G, I, D/K, L) system	
Teletext systems		FLOF (Fastext), TOP, WST (World Standard System)	
Power requirements		110 - 240 V AC, 50/60 Hz	
Power consumption		148 W, Standby: 2.8 W	
Screen size		Viewable area 66 cm (measured diagonally)	
Display resolution		1280 × 768 (W-XGA)	
Audio output		Rated Power output: 10 W + 10 W	
Speakers		6.6 cm round × 2	
EXT-1 terminal		Euroconnector (21-pin, SCART) • Video input, Audio L/R inputs and RGB inputs are available. • TV broadcast outputs (Video and Audio L/R) are available.	
EXT-2 terminal		Euroconnector (21-pin, SCART) • Video input, S-VIDEO (Y/C) input, Audio L/R inputs and RGB inputs are available. • Video and Audio L/R outputs are available. • T-V LINK functions are available.	
EXT-3 terminal		RCA connectors × 3 S-VIDEO connector × 1 • Video input, S-VIDEO (Y/C) input and Audio L/R inputs are available.	
EXT-4 terminal		RCA connectors × 5 • Component video (Pr, Pb, Y) inputs (625p, 525p, 1125i) and Audio L/R inputs are available. • 525p and 625p are progressive scanning signals. Some DVD players can output these signals. • 1125i is one of the new high-definition signals. However, 1125i broadcast is currently not available in Europe.	
AUDIO OUT terminal		RCA connectors × 2 • Audio L/R outputs are available.	
Headphone jack		Stereo mini-jack (3.5 mm in diameter)	
Dimensions (W × H × D)		703 mm × 560 mm × 260 mm 703 mm × 491 mm × 94 mm (TV only)	
Weight		19.0 kg 18.3 kg (TV only)	
Accessories		Remote control unit × 1 (RM-C1808) AA/R6 dry cell battery × 2 Mounting screw × 2 Hook × 2	

Design and specifications subject to change without notice.

Pictures displayed on the screen using this TV's ZOOM functions should not be shown for any commercial or demonstration purpose in public places (cafes, hotels, etc.) without the consent of the owners of copyright of the original picture sources, as this constitutes an infringement of copyright.

