



**JVC**

ENGLISH  
DEUTSCH  
FRANÇAIS  
ITALIANO

**JVC**

InteriArt

**LT-15B60SE**

**LCD PANEL TV**

**INSTRUCTIONS**

LCD-TV-GERÄT  
PANNEAU LCD TELEVISEUR  
TV A SCHERMO LCD

BEDIENUNGSANLEITUNG  
MANUEL D'INSTRUCTIONS  
ISTRUZIONI

## Contents

For your safety .....	1
Important Information .....	4
Remote Control Buttons .....	5
Control Panel Buttons .....	6
Using the stand .....	7
How to remove the stand .....	7
Installing TV on the wall .....	8
Preparation .....	9
Before Switching on your TV .....	9
Switching the TV ON/OFF .....	10
Initial Settings .....	11
Operating the TV .....	11
Menu System .....	12
Other Features .....	17
PC Mode .....	18
Teletext .....	20
Peripheral Equipment Connections .....	21
Antenna Connections .....	24
Peripheral Equipment Connections .....	24
PC Input Typical Display Modes .....	25
Tips .....	26
Specifications .....	27

## For your safety

This equipment has been designed and manufactured to meet international safety standards but, like any electrical equipment, care must be taken if you are to obtain the best results and safety is to be assured. So, please read the points below for your own safety. They are of a general nature, intended to help you with all your electronic consumer products and some points may not apply to the goods you have just purchased.

### Some “DOs” and “DON'Ts” for you

#### Air Circulation...

Leave at least 10cm clearance around the television to allow adequate ventilation. This will prevent the TV from overheating and consequential possible damage to the TV. Dusty places should also be avoided.

#### Heat Damage...

Damage may occur if you leave the TV in direct sunlight or near a heater. Avoid places subject to extremely high temperatures or humidity, or locations where the temperature is likely to fall below 5°C (41°F).

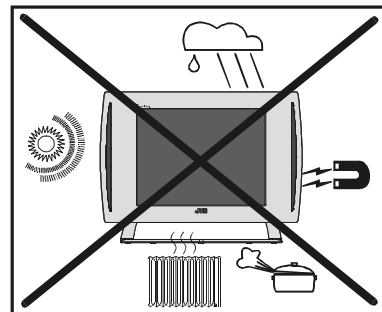

#### Mains Supply...

The mains supply required for this equipment is **100-240 V AC, 50 Hz**. Never connect to a DC supply or any other power source. DO ensure that the TV is not standing on the mains lead. DO NOT cut off the mains plug from this equipment, this incorporates a special Radio Interference Filter, the removal of which will impair its performance.

#### Hot / Moderate Climate Conditions

This device is suitable for working in hot and moderate climate conditions.

IF IN DOUBT PLEASE CONSULT A COMPETENT ELECTRICIAN.

**DO...**

**DO** read the operating instructions before you attempt to use the equipment.

**DO** ensure that all electrical connections (including the mains plug, extension leads and inter-connections between pieces of equipment) are properly made and in accordance with the manufacturers' instructions.

Switch off and withdraw the mains plug before making or changing connections.

**DO** consult your dealer if you are ever in doubt about the installation, operation or safety of your equipment.

**DO** be careful with glass panels or doors on equipment.

**DO NOT...**

**DON'T** remove any fixed cover as this may expose dangerous voltages.

**DON'T** obstruct the ventilation openings of the equipment with items such as newspapers, table-cloths, curtains etc. Overheating will cause damage and shorten the life of the equipment.

**DON'T** allow electrical equipment to be exposed to dripping or splashing or objects filled with liquids, such as vases, to be placed on the equipment.

**DON'T** place hot objects or naked flame sources, such as lighted candles or night-lights on, or close to the equipment. High temperatures can melt plastic and lead to fires.

**DON'T** use makeshift stands and NEVER fix legs with wood screws. To ensure complete safety, always fit the manufacturer's approved stand or legs with the fixings provided according to the instructions.

**DON'T** listen to headphones at high volume, as such use can permanently damage your hearing.

**DON'T** leave equipment switched on when it is unattended, unless it is specifically stated that it is designed for unattended operation or has a standby mode. Switch the equipment off and make sure your family know how to do

this. Special arrangements may need to be made for infirm or handicapped people.

**DON'T** continue to operate the equipment if you are in any doubt about it working normally, or it is damaged in any way – switch off, withdraw the mains plug and consult your dealer.

**DON'T** put the empty batteries into garbage instead of recycle bin to reduce harmful effects to the environment.

**ABOVE ALL – NEVER let anyone, especially children, push anything into holes, slots or any other openings in the case – this could result in a fatal electric shock.**

NEVER guess or take chances with electrical equipment of any kind – it is better to be safe than sorry.

**To fully disconnect the TV, switch off the mains socket and remove the Power plug. Safety Precautions for Power adaptor**

- Be careful! May become hot.
- For indoor and dry location use only.
- Risk of electric shock.
- Shock hazard, do not open.
- Keep all power adaptors away from any other heat source.
- Always use power adaptor(s) well-ventilated area.

*\*\* Cold cathode fluorescent lamp in LCD PANEL contains a small amount of mercury, please follow local ordinances or regulations for disposal.*

**"The LCD panel is very high technology product with about a million thin film transistors, giving you fine picture details. Occasionally, a few non-active pixels may appear on the screen as a fixed point of blue, green or red. Please note that this does not affect the performance of your product." Please note that certain light guns used with games consoles may not work on this product.**

**Warning:**

**This is a Class A product. In a domestic environment this product may cause radio interference in which case the user may be required to take adequate measures.**

**WARNING :** TO PREVENT FIRE OR SHOCK HAZARD, DO NOT EXPOSE THIS APPLIANCE TO RAIN OR MOISTURE.

**WARNING**

- *Do not allow children to hang from the TV, place their elbows on the TV or lean against the TV. Doing so may cause the TV to fall over and lead to injuries.*

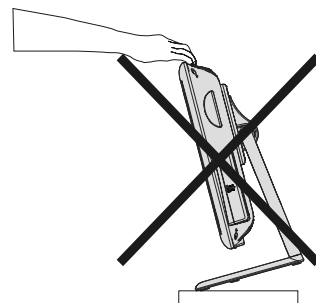

**CAUTION:**

- *To avoid electric shock or damage to the unit, first firmly insert the small end of the power cord into the AC Adaptor unit it is no longer wobbly, and then plug the larger end of power cord into an AC outlet.*

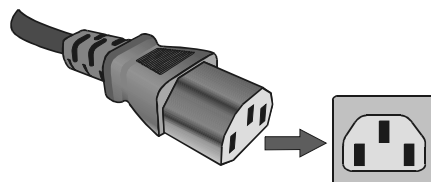

**CAUTION:**

- *The TV screen may be damaged if the TV is carried as shown in the diagram.*

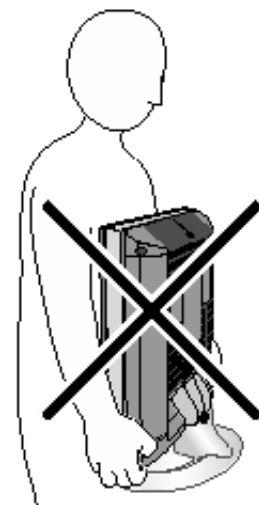

# Important Information

## Please take note

### EXCLUSION CLAUSE

JVC shall under no circumstances be liable for loss and/or damage to the product caused by:

- fire;
- earthquake;
- accidental damage;
- intentional misuse of the product;
- use of the product in improper conditions;
- loss and/or damage caused to the product whilst in the possession of a third party;
- any damage or loss caused as a result of the owner's failure and/or neglect to follow the instructions set out in the owner's manual;
- any loss or damage caused directly as a result of misuse or malfunction of the product when used simultaneously with associated equipment;

Furthermore, under no circumstances shall JVC be liable for any consequential loss and/or damage including but not limited to the following, loss of profit, interruption of business, the loss of recorded data whether caused during normal operation or misuse of the product.

### **WARNING! NEVER LEAVE A STATIONARY IMAGE ON THE SCREEN**

If stationary images generated by TELETEXT, CHANNEL IDENTIFICATION LOGOS, COMPUTER DISPLAYS, VIDEO GAMES, ON SCREEN MENUS, etc. are left on the TV screen for any length of time, they could become permanently ingrained.

If you use your television to display completely still images, or moving pictures which have a permanent still image superimposed e.g. broadcast network logos, it is always advisable to reduce BOTH the brightness and contrast settings.

### **Care and disposal**

#### **Cleaning the screen and cabinet...**

Turn off the power, clean the screen and cabinet with a soft, dry cloth. We recommend that you do not use any proprietary polishes or solvents on the screen or cabinet as this may cause damage.

#### **Disposal...**

When the set reaches the end of its useful life please dispose of it in accordance with Local Government Regulations or at a recycling centre.

# Remote Control Buttons

- ① = (Stand By) button
- ② TV / VCR / DVD Switch
- ③ Number buttons
- ④ **AV** button (EXT-1, EXT-1S, EXT-1RGB, EXT-2, EXT-2S or PC)
- ⑤ **BLUE / PICTURE** Mode button
- ⑥ **YELLOW** / Sleep Timer button
- ⑦ **MENU** button
- ⑧ = Cursor Up button
- ⑨ **OK** button
- ⑩ = Cursor Right button
- ⑪ **BACK** button
- ⑫ Volume Up/Down buttons
- ⑬ Teletext / VCR / DVD Control buttons
- ⑭ Programme Up/Down buttons
- ⑮ = Cursor Down button
- ⑯ = Teletext Button
- ⑰ = Cursor Left button
- ⑱ = Stereo / Bilingual button
- ⑲ **GREEN** / Hyper Sound On/Off button
- ⑳ **RED / ZOOM** Mode button
- ㉑ = Information Button
- ㉒ = Mute button

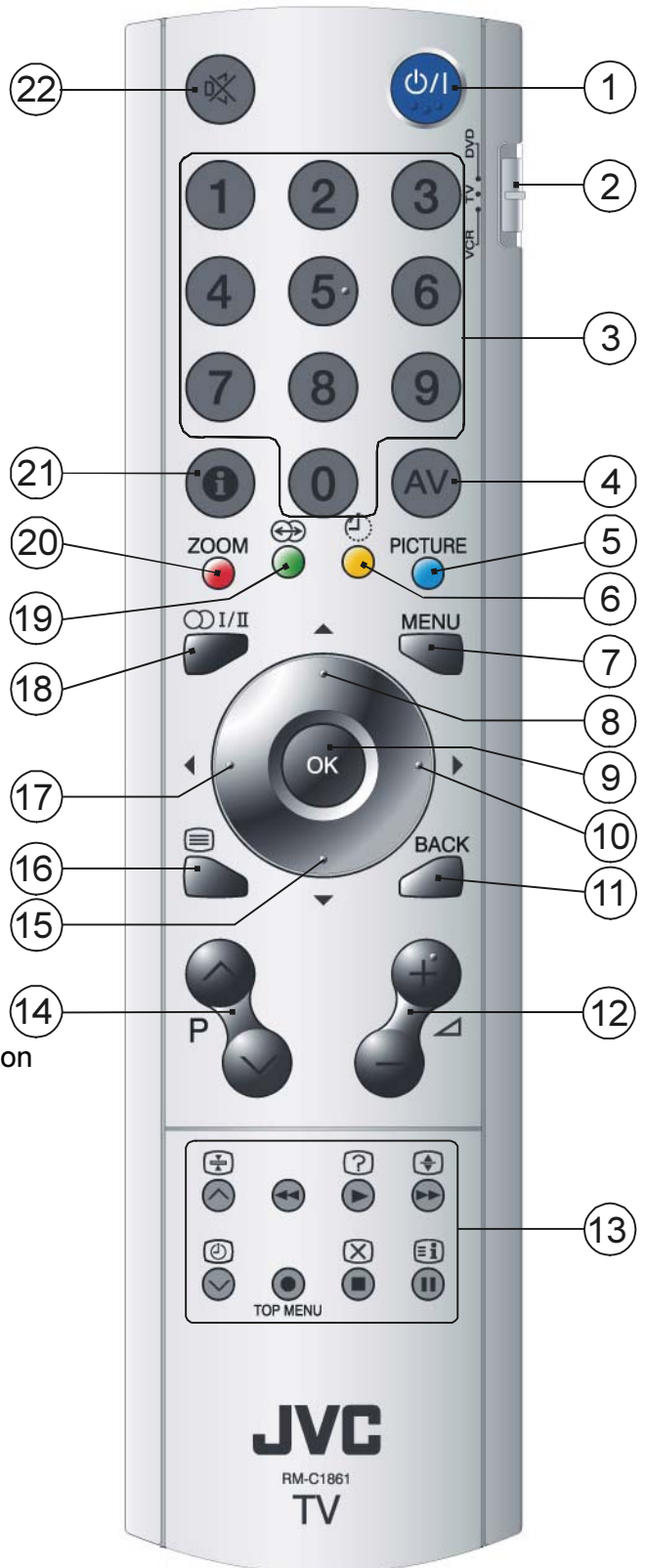

# Control Panel Buttons

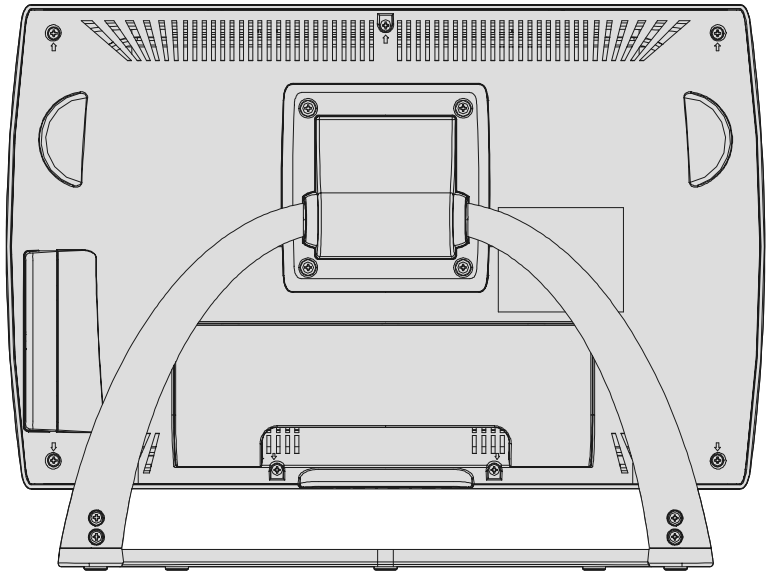
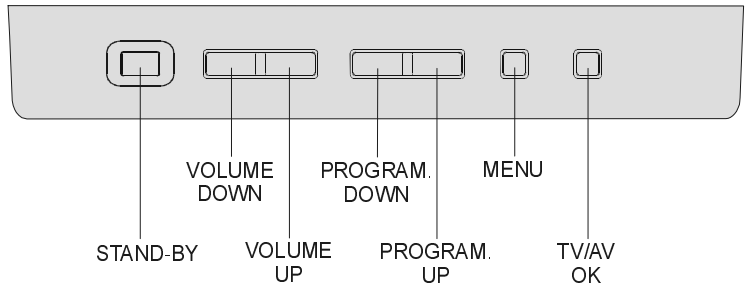
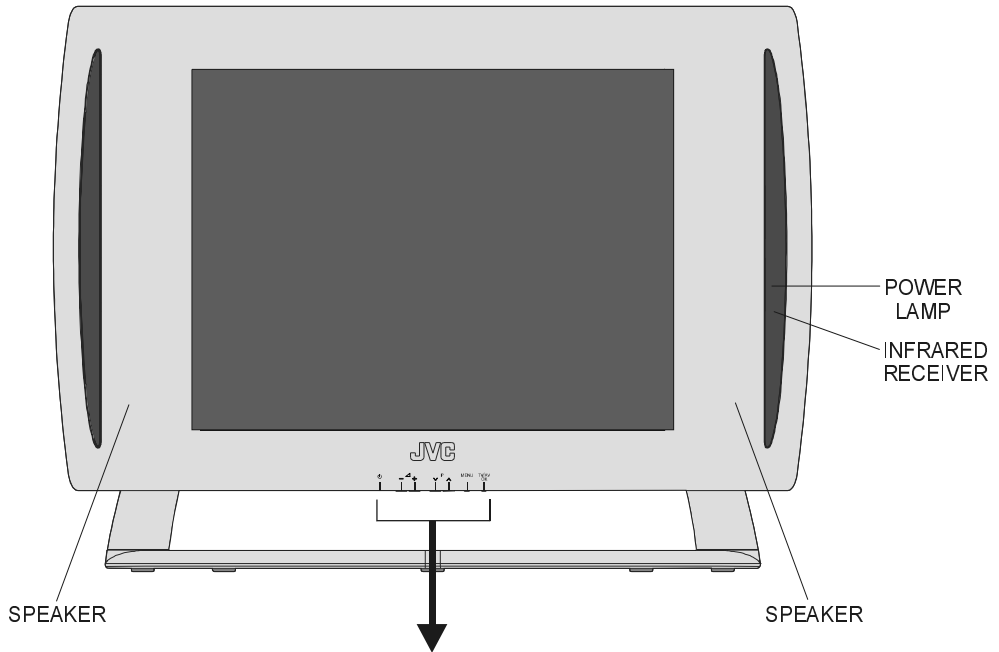

## Using the stand

This TV comes with a Table Top Stand already attached.

This stand can be used to adjust the direction of the TV screen.

### Tilt the TV up and down:

While holding the stand with one hand which should be on lower level of the stand for avoiding trapping, use your other hand to hold the middle of the top of the TV and slowly tilt the TV up and down.

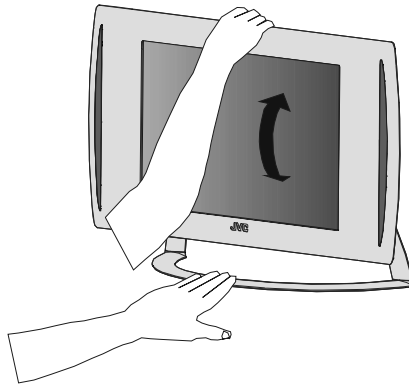

## How to remove the stand

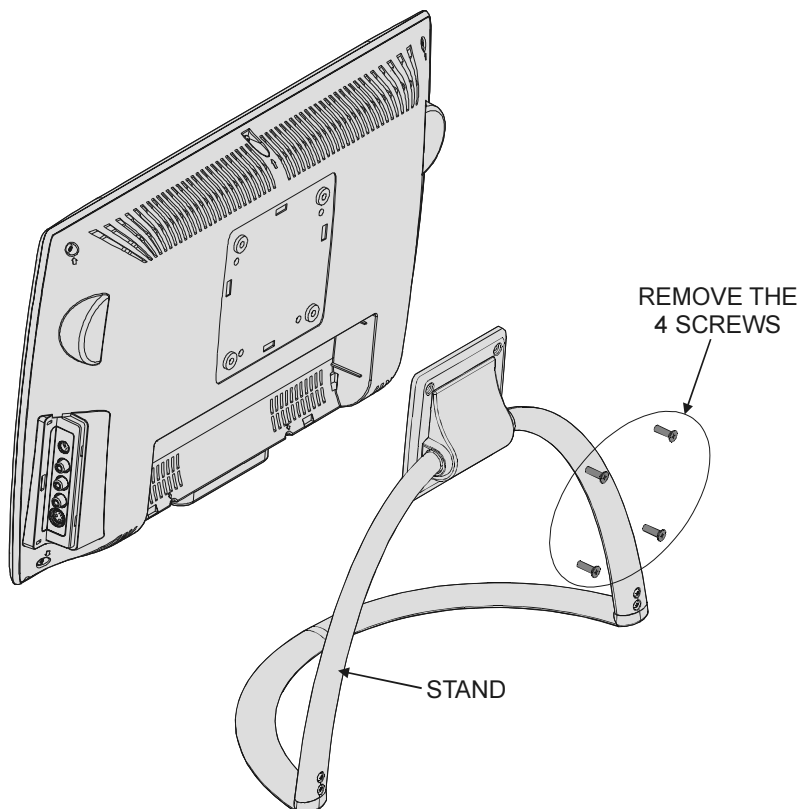



## Installing TV on the wall

### WARNING

- When you install the TV on the wall, only use a JVC wall mounting unit (optional) which is designed for this TV.
- Make sure that the TV is installed on the wall by a skilled installer.

Locate the TV away from direct sunlight and strong lights, soft, indirect lighting is recommended for comfortable viewing. Place on a sturdy platform, the mounting surface should be flat and steady, it should then be secured to the wall with a sturdy tie using the hook on the back of the TV, this will prevent it from falling over. Use curtains or blinds to prevent direct sunlight falling on the screen.

A floor and table top stand are available for this television, or an angled bracket which enables the TV to be wall-mounted.

The LCD display panels are manufactured using an extremely high level of precision technology, however sometimes some parts of the screen may be missing picture elements or have luminous spots. This is not a sign of a malfunction.

Make sure the TV is located in a position where it cannot be pushed or hit by objects, as pressure will break or damage the screen.

- 100 mm mount based on VESA regulation is equipped.

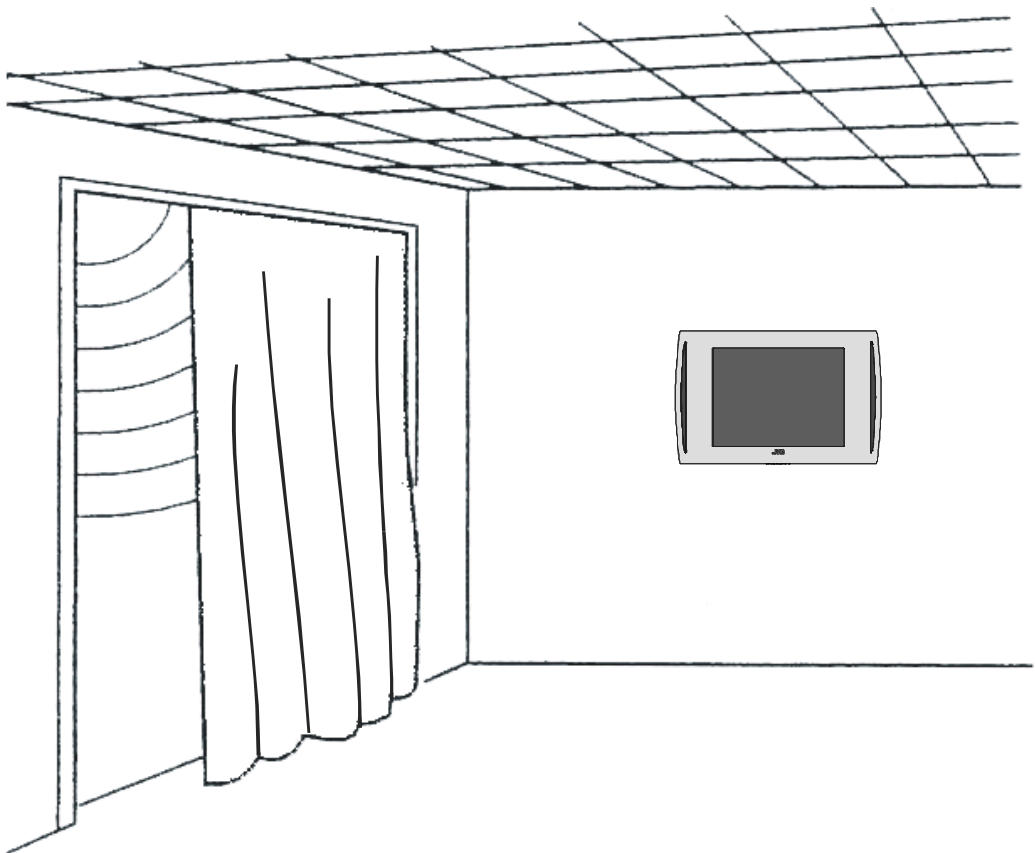

## Preparation

Install Display on solid horizontal surface such as a table or desk.

For ventilation, leave a space of at least 10 cm free all around the set. To prevent any fault and unsafe situations, please do not place any objects on top of the set.

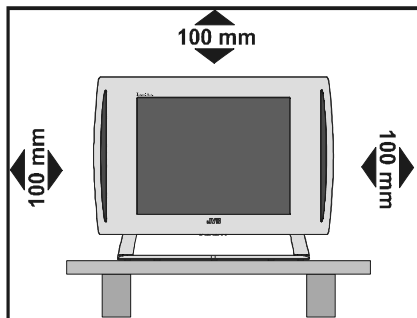

## Features

- It is a remote controlled colour television and PC monitor.
- 100 programmes from VHF, UHF bands or cable channels can be preset.
- It can tune cable channels.
- Controlling the TV is very easy by its menu driven system.
- It has an Euroconnector socket for an external device (such as VCR, DVD player, video games etc.)
- German+Nicam stereo sound system.
- Multilanguage OSD.
- Teletext (Fastext, 7 pages).
- It is possible to connect headphone.
- A.P.S. (Automatic programming system)
- All programmes can be named.
- Forward or backward automatic tuning.
- Sleep timer.
- Child lock
- Auto, 4:3, 16:9
- Automatic sound mute when no transmission.
- When no valid signal is detected, after 5 minutes the TV switches itself automatically to stand-by mode.
- NTSC Playback.

- PLL (Frequency Search)
- PC input (Support Up to 1024 x 768)

## Before Switching on your TV

### Power connection

Only use the adaptor supplied with this product.

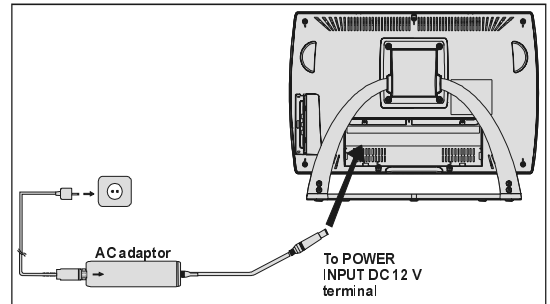

**IMPORTANT:** The TV set is designed to operate on 12 V DC. For this, an adaptor is used which gives 12V DC voltage. Connect this adaptor to a system that supplies 100-240V AC, 50 Hz.

- After unpacking, allow the TV set to reach the ambient room temperature before you connect the set to the mains.

### Connections to the RF input socket

- Connect the aerial or cable TV plug to the RF input socket located at the back of the TV and connect the cable plug coming out from the TV out socket located at the devices (VCR, DVB etc.) to this socket as well.

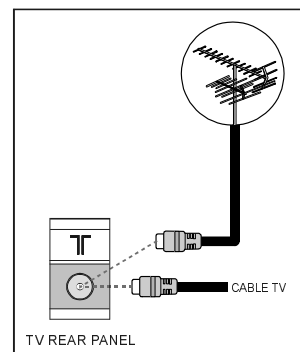

## How to connect other devices

**IMPORTANT:** Switch off the TV before connecting any external device.

Sockets for external connections are at the back of the TV. For connection of other devices via Euroconnector refer to the manuals of the related devices.

## Inserting batteries in the remote control handset

- Remove the battery cover located on the back of the handset by gently pulling downwards from the indicated part.
- Insert two AAR6 dry cell or equivalent type of batteries inside.
- Replace the battery cover.

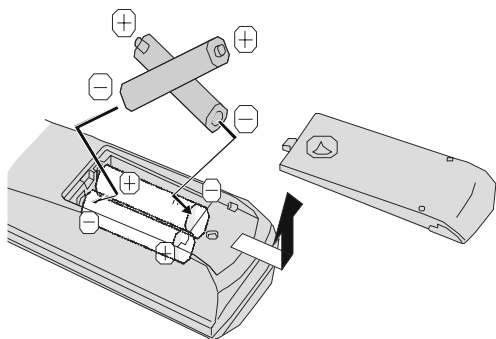

**NOTE:** Remove the batteries from remote control handset when it is not to be used for a long period. Otherwise it can be damaged due to any leakage of battery.

Old batteries must be disposed in a designated area. If performance of the remote control reduces, replace the batteries with the correct type. Do not combine a used, old battery or a new one or mixed battery types. Remove dead batteries immediately to prevent acid from leaking into the battery compartment.

## Switching the TV ON/OFF

### To switch the TV on

Your TV will switch on in two steps:

- 1- Connect the power supply cord to the system. Then the TV switches itself to stand-by mode and the power lamp becomes red.
- 2- To switch on the TV from stand-by mode either:

Press the “**⏻ / I**” button on the remote control or at the bottom of the TV,

or,

Press a digit button on the remote control so that a programme number is selected,

or,

Press “**P∨**” or “**P∧**” buttons on the remote control or at the bottom of the TV, so that last switched off programme is selected.

Either way the TV will switch on and the power lamp will become green.

### To switch the TV off

- Press the “**⏻ / I**” button on the remote control or at the bottom of the TV, so the TV will switch to stand-by mode and the power lamp will become red.

**NOTE:** To switch the TV off completely remove the mains plug from the socket.

## Initial Settings

### First A.P.S. (Automatic Programming System)

The following menu will be displayed on the screen when you turn the TV on for the first time. A.P.S. searches and sorts all channels and stores them automatically on your TV, according to the transmission of programme systems in your area.



First of all choose **language** and **country** by using “▲” / “▼” and “◀” / “▶” buttons. This will affect the sort process in A.P.S. To start A.P.S., select **A.P.S.** by using “▲” / “▼” buttons and press the “▶” or “OK” button. The following warning is displayed.

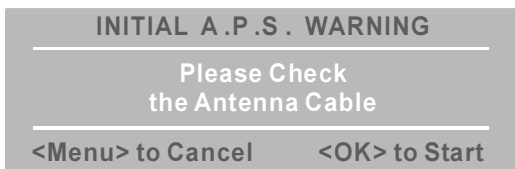

Press the “OK” button to start A.P.S.

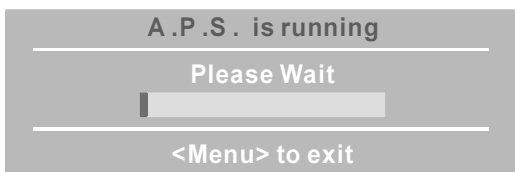

After A.P.S. is finalized, Program Table will be displayed on the screen. In the Program Table you will see the programme numbers and names assigned to the programmes.

## Operating the TV

*You can operate your TV using both the remote control handset and onset buttons.*

Volume setting and programme selection can be made by using the buttons on the bottom of the TV.

### Operating with the buttons on the TV

#### Volume Setting

- Press “-∟” button to decrease volume or “∟+” button to increase volume, so a volume level scale (slider) will be displayed at the middle of the bottom on the screen.

#### Programme Selection

- Press “P^” button to select the next programme or “∇P” button to select the previous programme.

#### Switching input mode

- Pressing **TV/AV/OK** button will change the input mode.

#### Entering Main Menu

- Press “**MENU**” button to enter Main menu. In the Main menu select submenu using “∇P” or “P^” button and enter the sub-menu using “-∟” / “∟+” or **TV/AV/OK** button. To learn the usage of the menus, refer to the Menu System sections.

### Operating with Remote Control

The remote control handset of your TV is designed to control all the functions of the model you selected. The functions will be described in accordance with the menu system of your TV.

Functions of the menu system are described in following sections.

#### Volume Setting

Press “**▲ +**” button to increase volume. Press “**▲ -**” button to decrease volume. A volume level scale (slider) will be displayed in the middle at the bottom of the screen.

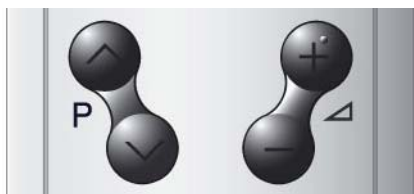

### Programme Selection (Previous or next programme)

- Press “P∨” button to select the previous programme.
- Press “P∧” button to select the next programme.

### Programme Selection (direct access)

Press digit buttons on the remote control to select programmes between 0 and 9. TV will switch to the selected programme. To select programmes between 10 - 99, press the digit buttons consecutively which programme you want to select (eg. for programme 27, first press 2 and then 7). When it is late to press second digit button only the first digit programme will be displayed. The limit of the delay time is 3 seconds.

Example: PR6 → press 6

PR12 → press 1 and 2

Press directly the programme number to reselect single digit programmes.

**Hint:** The channel list numbers are assigned by the broadcasters. Because not all channels are broadcast free-to-air and stored by the receiver, the channel list numbers do not run continuously. The fifteenth channel in the list, for example, may not be channel number 15 but channel number 17.

## Menu System

Your TV has been designed with a menu system to provide an easy manipulation of a multi-function system. The TV is controlled by choosing the commands, which are displayed on the screen.

Press the “MENU” button. The menu will be displayed in the middle of the screen.

Press “◀” or “▶” button to select a menu title and then “▲” or “▼” button to select a menu item. Press “◀” / “▶” or “OK” buttons to enter the menu item.

In AV modes, menus appear the same as in TV mode except the Installation menu.

- Press the “MENU” button again to remove menu.
- Press the “BACK” button to return to the previous menu.

### Picture Menu

By pressing “◀” or “▶” button, select the first icon. Picture menu appears on the screen.

#### Setting Mode

- As you enter the picture menu, Mode will be the first item.
- By pressing “◀” or “▶” button you may choose one of these options:

#### Manual, Bright, Standard and Soft.

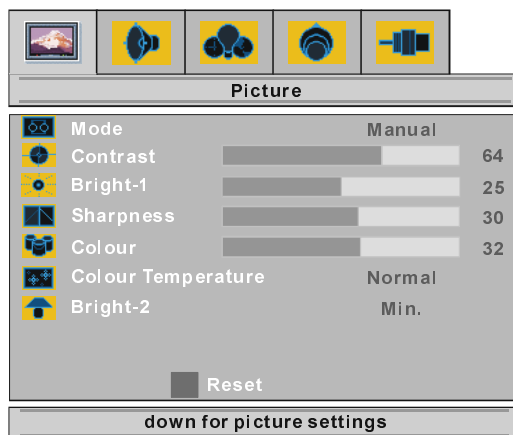

- **Bright, Standard and Soft** modes are all preset. When these modes are selected Contrast, Bright-1, Sharpness and Colour can not be changed. They can only be changed when **Manual** is selected as a picture mode.

## Setting Contrast

- Using “▲” or “▼” button select **Contrast**.
- Press “▶” button to increase contrast level.
- Press “◀” button to decrease contrast level.

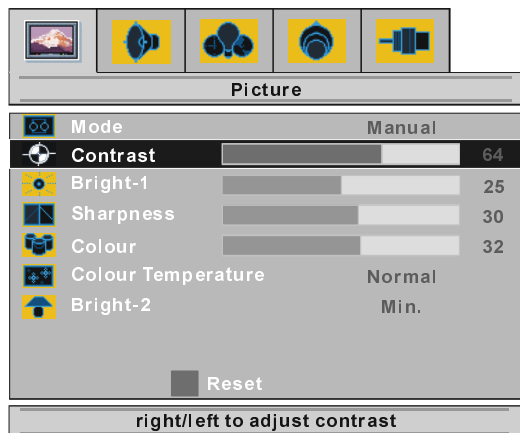

## Setting Bright-1

- Using “▲” or “▼” button select **Bright-1**.
- Press “▶” button to increase brightness.
- Press “◀” button to decrease brightness.

## Setting Sharpness

- Using “▲” or “▼” button select **Sharpness**.
- Press “▶” button to increase sharpness level.
- Press “◀” button to decrease sharpness level.

## Setting Colour

- Using “▲” or “▼” button select **Colour**.
- Press “▶” button to increase colour level.
- Press “◀” button to decrease colour level.

## Setting Colour Temperature

- Using “▲” or “▼” button select **Colour Temperature**.
- Press “◀” or “▶” button to select “Warm”, “Cool” or “Normal”.

## Setting Bright-2

This item changes the back light of the picture.

- Using “▲” or “▼” button select **Bright-2**.
- Press “◀” or “▶” button to select “Min.”, “Med.”

or “Max.”.

## Setting Hue

This item is displayed in Picture menu when the TV receives an NTSC signal.

- Using “▲” or “▼” button select **Hue**.
- Press “▶” button to increase hue level.
- Press “◀” button to decrease hue level.

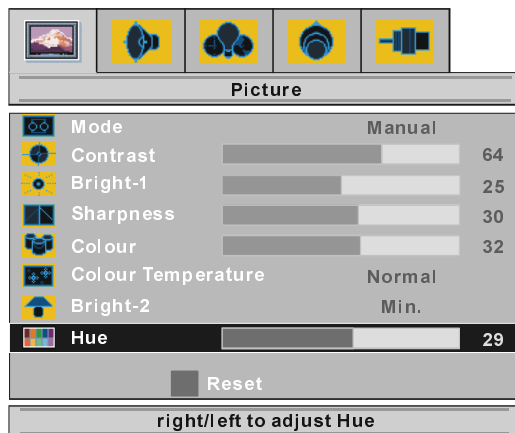

## Reset

Press BLUE button to reset the **Manual** mode settings to factory default settings.

## To Store the Settings

In the Picture Menu, all settings are stored automatically.

## Sound Menu

By pressing “◀” or “▶” button, select the second icon. Sound menu appears on the screen.



## Setting Volume

- Press “▶” button to increase volume.
- Press “◀” button to decrease volume.

Or you can directly change the volume settings using “▲ +” (to increase) or “- ▲” (to decrease) button.

## Setting Bass Level

- Using “▲” or “▼” button select **Bass Level**.
- Press “▶” button to increase bass level.
- Press “◀” button to decrease bass level.

## Setting Treble Level

- Using “▲” or “▼” button select **Treble**.
- Press “▶” button to increase treble level.
- Press “◀” button to decrease treble level.

## Setting Balance

It allows adjusting the distribution between the left and right speakers.

- Using “▲” or “▼” button select **Balance**.
- Press “▶” button to change balance rightward.
- Press “◀” button to change balance leftward.

## Hyper Sound

- Using “▲” or “▼” button select **Hyper Sound**.
- Pressing “◀” or “▶” button will turn this feature on or off.

Pseudo/spatial effect can be turned on or off via the Hyper Sound item in the Sound menu or by remote control. In Mono transmission the left and right channels will be added at left channel and dummy stereo effect will be introduced to end-user. In stereo transmission it yields a phase difference between left and right channels.

## To Store The Settings

In the Sound Menu, all settings are stored automatically.

## Feature Menu

By pressing “◀” or “▶” button, select the third icon. Feature menu appears on the screen.



## Sleep Timer

The **Sleep Timer** is used to turn the TV off after a defined period of time after selecting this item. The timer can be programmed between Off and 120 minutes in steps of 10 minutes. (Off, 10, 20, 30, ... , 110, 120)

If sleep timer is activated, at the end of the selected time, the TV goes automatically to stand-by mode.

## Child Lock

You can use this feature to prevent children changing programmes or adjustments etc. without remote control.

- Using “▲” or “▼” button select **Child Lock**.
- Press “◀” / “▶” button to select Child Lock On or Off.

When **Off** is selected, there will be no difference in the operation of your TV. When **On** is selected, the TV can only be controlled by the remote control handset. In this case the control panel buttons, except “⏻” button, at the bottom of the TV will not work.

## Selecting Menu Language

- Using “▲” or “▼” button select **Language**.
- Press “◀” or “▶” button to select menu language.

## Blue Back

You can set the TV to automatically change to a blue screen if the signal is weak or absent, or when there is no input from an external device.

The **Blue Background** feature can be turned on or off by pressing “◀” or “▶” button.

## To Store Settings

In Feature menu all settings are stored automatically.

## Installation Menu

By pressing “◀” or “▶” button, select the fourth icon. Installation menu appears on the screen.

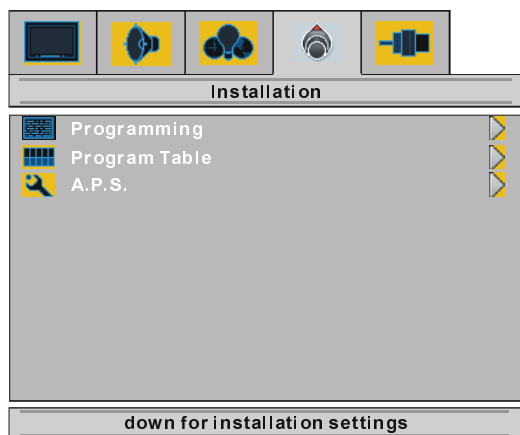

## Programming Menu

By pressing “▲” or “▼” button, select Programming and press “▶” button. Programming menu appears on the screen.

### Selecting Program Number

- Using “▲” or “▼” button select Program Number.
- To select a program number, you can use “◀” / “▶” button or Digit Buttons.



### Setting Program Name

- Using “▲” or “▼” button select Program Name.
- Press “▶” button to select a character and “▲” or “▼” button to change it.
- After the program name is entered, press “◀” button to exit.

### Selecting Band

Band, can be chosen either,

- “C” or “S” by pressing “◀” or “▶” button.

### Selecting Channel

**Channel** can be changed by “◀” or “▶” button or by Digit Buttons.

### Selecting Colour System

Using “◀” or “▶” button on **Colour System**, you can change the colour system to **PAL**, **SECAM** or **AUTO**.

**Note:** In EXT mode, you can choose NTSC 3.58 and NTSC 4.43 as well.

### Selecting Sound System

Using “◀” or “▶” button on **Sound System**, you can change the standard to **BG, I, DK, L/L’**.

### Selecting Fine Tuning

You can use the Fine Tuning process for fine adjustment (after coarse adjustment), if you are not happy about the image on the screen.

Use “◀” or “▶” button on **Fine Tuning** item, until getting the best image on the screen.

### Selecting Manual Search

To start the manual search process, press “▶” button for forward search or “◀” button for backward search. If a signal is found or reaches to end of the band after searching, press “◀” or “▶” buttons to continue search process. To stop the search process when you want, press the **MENU** button at any time.

### Setting VCR (Video Cassette Recorder) Mode

- This item can be seen in **TV**, **EXT-1** and **EXT-2** modes.



- If you want to watch a **VCR** source, then it will be better to set **VCR** mode “on”. For this, while the cursor is on this item press the “◀” or “▶” button to set it “On”.
- If you want to watch a **DVD**, then you must set this item “off”; because **DVD** is not a source like a **VCR** and to see the picture better, you must set the **VCR** mode “Off”.

## To Store Settings

- Press “▶” button on **Store** option to store Programming menu settings.
- You can also store a setting by pressing “OK” button on the selected setting.
- “**STORING**” is displayed on screen during the store process.

## Program Table

By pressing “◀” or “▶” button, select the second icon. Program table appears on the screen.

1	ITV	13	----	25	----
2	ZDF	14	----	26	----
3	BBC1	15	----	27	----
4	C 5	16	----	28	----
5	C 6	17	----	29	----
6	C 8	18	----	30	----
7	S 40	19	----	31	----
8	C 21	20	----	32	----
9	----	21	----	33	----
10	----	22	----	34	----
11	----	23	----	35	----
12	----	24	----	36	----

Program table shows the programme numbers and the names assigned to the programmes.

Here you can adjust the channel order by moving or deleting the channels.

First of all press the “▼” button.

Using the **GREEN** button you can move a programme into another programme’s location. Press the direction buttons to select a programme and press the **GREEN** button. Then select another programme and press the **GREEN** button again. The first selected programme moves into the location of the second selected programme.

Using the **YELLOW** button you can delete any programme you want.

## A.P.S. (Auto Programming System)

By pressing “▶” button, select the third icon. A.P.S. menu appears on the screen.



## country

By pressing “▲” or “▼” button, select **country**. Press “◀” or “▶” button to select the country where you are.

## A.P.S.

By pressing “▲” or “▼” button, select **A.P.S.** When “▶” or “OK” button is pressed, the following warning is displayed.

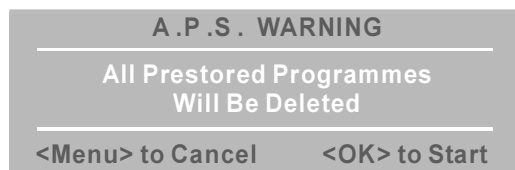

If you want to cancel A.P.S. function, press the “**MENU**” button.

If “**OK**” button is pressed, A.P.S. starts and the following warning is displayed.

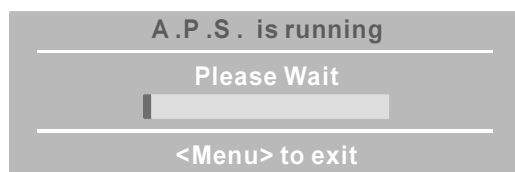

If you press the “**MENU**” button, A.P.S. function stops and Program table appears on the screen.

If you wait till A.P.S. is finalized, Program table is displayed with the programmes found and located.

## Source Menu

By pressing “◀” or “▶” button, select the fifth icon. Source menu appears on the screen.



Use “▲” or “▼” button to select a mode and then press “▶” or “OK” button to switch to that mode. You can also switch your TV to EXT modes by pressing directly to “AV” button.

## Other Features

### TV Status

**Programme Number, Programme Name and Sound Indicator** are displayed on screen after programme change for 3 seconds.

This information is also displayed by pressing the “i” button. Pressing this button again shows the current time. Pressing this button once more removes the on-screen display.



## To Display the Time

While watching a TV programme with teletext transmission, press “i” button twice. The current time information captured from teletext will be displayed on the screen.

If the programme being watched does not have teletext transmission, no time information will be displayed.

The time information will disappear after pressing the “i” button again.

## Sound Indicator

“I/II” button is used to select Mono or Stereo, or Dual I or Dual II.

Mono

In Mono broadcast or in forced-mono (for stereo broadcast).

Stereo

In Stereo broadcast.

Dual I

If dual broadcast is detected. Dual I is selected in default and also can be selected after Dual II by Remote Control.

Dual II

If Dual II is selected by Remote Control.

## Hyper Sound

By selecting Hyper Sound in sound menu or by pressing the “↔” button on your remote control, Pseudo/Spatial effect can be turned on or off.

In Mono transmission the left and right channels will be added at left channel and dummy stereo effect will be introduced to end-user.

In stereo transmission it yields a phase difference between left and right channels.

## Picture Mode

Picture mode OSD is displayed when BLUE button is pressed. Picture mode can be changed to Manual, Bright, Standard and Soft.

## Sleep Timer

Sleep Timer mode OSD is displayed when YELLOW button is pressed. See page 14 for detailed information.



## Mute Indicator

It is placed in the upper right side of the screen when enabled, and it stays there until it is disabled.



To cancel mute, there are two alternatives; the first one is by pressing the “” button, this volume is set to the preceding value, and the second one is increasing or decreasing the volume level.



## Volume Bar

It is displayed in the lower middle of the screen. When a volume command is received (pressing “ +” or “ -” by Remote Control or Control panel at the bottom of the TV) and no menu is active, it stays on the screen for 3 seconds, after the last volume command or until another command is received in between.



## EXT Modes

By pressing the “**AV**” button you can switch your TV to EXT modes (except being in Teletext). Pressing this button consecutively will switch the TV in one of the optional EXT modes: **EXT-1**, **EXT-1S**, **EXT-1RGB**, **EXT-2**, **EXT-2S** and **PC**.

In order to quit the EXT mode press any digit buttons or “**P**” or “**P**”.

## Zoom Modes

Zoom mode can be changed by pressing Red button. You can change the screen size according to the picture aspect ratio. Select the optimum one from the following **ZOOM** modes: **Auto**, **4:3** and **16:9**.

## AUTO

When a **WSS (Wide Screen Signalling)** signal, which shows the aspect ratio of the picture, is included in the broadcast signal or the signal from an external device, the TV automatically changes the **ZOOM** mode to **4:3** or **16:9** according to the **WSS** signal.

- When the **AUTO** mode does not function correctly due to poor **WSS** signal quality or when you want to change the **ZOOM** mode, change to another **ZOOM** mode manually.

## PC Mode

### Installation

- Power off both Computer and Display before making any connections.
- Set your PC's resolution correctly before connecting to the TV. See the table in page 25 for supported modes.
- Use a D-SUB cable to connect the TV's PC input to the computer's RGB output terminal.

15 Pin Mini D-Sub Connector

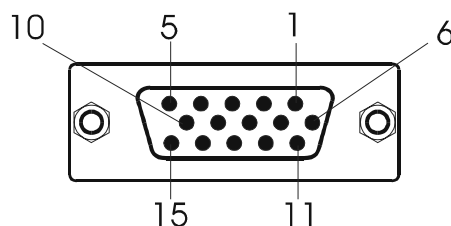



- Tighten the screws of the Display cable until the connectors are fastened securely (finger-tighten only).

### Menu System in PC mode

Press the “**MENU**” button. The menu will be displayed in the middle of the screen.

### PC Picture Menu

By pressing “” or “” button, select the first icon. PC Picture menu appears on the screen.

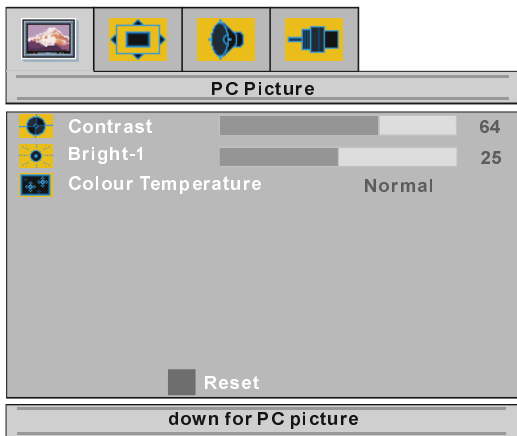

The items in this menu are described at **Picture menu** starting page 12.

Press BLUE button to reset the **Manual** mode to factory default settings.

## PC Picture Position Menu

By pressing “◀” or “▶” button, select the second icon. PC Picture Position menu appears on the screen.

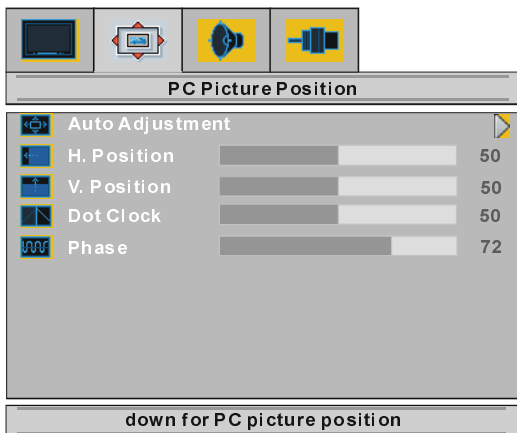

### Auto Adjustment

If you shift the picture horizontally or vertically to an unwanted position, use this item to put the picture into correct place automatically.

- Select **Auto Adjustment** item by using “▲” or “▼” buttons.
- Press “▶” button.
- Press “MENU” button or “BACK” button to store the value.

**Warning:** Auto position adjustment recommended to be done with the full screen image for the proper adjustment.

### Horizontal Position

This item shifts the image horizontally to right hand side or left hand side of the screen.

- Select **H. Position** item by using “▲” or “▼” button.
- Use “◀” or “▶” button to adjust the value.
- Press “MENU” button or “BACK” button to store the value.

### Vertical Position

This item shifts the image vertically towards the top or bottom of the screen.

- Select **V. Position** item by using “▲” or “▼” button.
- Use “◀” or “▶” button to adjust the value.
- Press “MENU” button or “BACK” button to store the value.

### Dot Clock

**Dot Clock** adjustments correct interference that appear as vertical banding in dot intensive presentations like spreadsheets or paragraphs or text in smaller fonts.

- Use “◀” or “▶” button to adjust the value.

### Phase

Depending on the resolution and scan frequency that you input to the TV Set, you may see a muddy or noisy picture on the screen. In such a case you can use this item to get a clear picture by trial and error method.

- Use “◀” or “▶” button to adjust the value.

## Sound Menu

By pressing “◀” or “▶” button, select the third icon. Sound menu appears on the screen.

The items in this menu are described at **Sound menu** starting page 13.

## Source Menu

By pressing “◀” or “▶” button, select the fourth icon. Source menu appears on the screen.



Use “▲” or “▼” button to select a mode and then press “▶” or “OK” button to switch to that mode.

### Sound in PC mode

- Connect the PC’s Audio output to the TV’s **PC Audio In** socket with an audio cable.

## Teletext

Teletext is an information system that displays text on your TV screen. Using the Teletext information system you can view a page of information on a subject that is available in the list of contents (index).

On screen display is not available in text mode. Contrast, brightness or colour control is not available, but volume control is available in text mode.

### To operate Teletext

- Select a TV station on which Teletext is being transmitted.
- Press (TELETEXT) “” button. Usually the list of contents (index) is displayed on the screen.

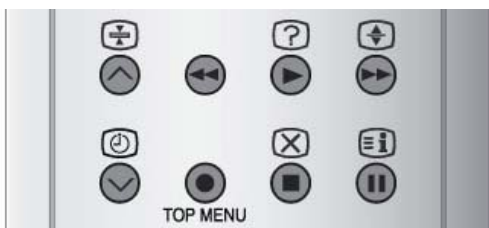

### To select a page of Teletext

- Press the appropriate digit buttons for the required Teletext page number.



The selected page number is displayed at the top left corner of the screen. The Teletext page counter searches until the selected page number is located, so that the desired page is displayed on the screen.

- Press “P^” button to move the Teletext screen forward one page at a time.
- Press “Pv” button to move the Teletext screen backward one page at a time.



### To Select Index Page

- To select the page number of the index (generally page 100), press “” button.



### Searching for a teletext page while watching TV

- In the Teletext mode pressing “” button will switch the screen to the TV mode. In the TV mode enter a page number using digit buttons. The page will be searched and the page number will be displayed on the upper left corner of the screen when the selected page is found. Now you can display this teletext page by pressing “” button.

### To Select Double Height Text

- Press “” button for the top half of the information page to be displayed in double height text.
- Press “” button again for the bottom half of the information page to be displayed in double height text.
- Press “” button once more for the full page of normal height text.

### To Reveal “concealed” Information

- Pressing “” button once will reveal answers on a quiz or games page.
- Pressing “” button again will conceal the revealed answers.

## To Stop Automatic Page Change

The teletext page you have selected may contain more information than what is on the screen; the rest of the information will be displayed after a period of time.

- Press “

## To Select a Subcode Page

Subcode pages are subsections of long Teletext pages that can only be displayed on the screen one section at a time.

- Select the required Teletext page.
- Press “

## To exit Teletext

- Press “

## Fastext and Toptext

Your TV supports the 7 page Teletext system. When the page number of any of the 7 pages in memory is entered, the system will not search for the requested page; instead it will display the page automatically.

- Press “**P**

## For Fastext and Toptext

The subject-heading for the information may have a particular colour.

- Press an appropriate **RED**, **GREEN**, **YELLOW** or **BLUE** button in order to reach the relevant page quickly.

## For TOPTTEXT

If Toptext transmission is present, colour coded buttons will appear in status row.

If Toptext transmission is not present, status row will not appear.

In Toptext mode the “**P**

## Peripheral Equipment Connections

There is a wide range of audio and video equipment that can be connected to your TV.

Connection diagrams at the end of this section show you where the different equipment should be connected at the back side of the TV.

### Via the Euroconnector

Your TV set has one Euroconnector socket. If you want to connect peripherals (e.g. video, decoder, etc.) which have Euroconnectors, to your TV, use **EXT-1** input.

If an external device is connected via Euroconnector socket, TV is switched to AV mode automatically.

### RGB mode

If an equipment can output the **RGB** signals, connect it to the **EXT-1** terminal.

### Via the RCA jacks

If you have an equipment (such as a Camcorder) which has the RCA jacks, connect it to the **EXT-2** terminal with the video and audio cables.

## Via the ANT (aerial) socket

If your equipment does not have an Euroconnector or RCA jacks, connect it to the TV with an aerial cable. For details, see the manual provided with the equipment.

- To store the test signal that comes from the equipment, see “**Installation Menu**” on page 15 and store it to the program number 0. You can watch images from that equipment to select the program number which you stored the test signal.

## Decoder

Cable TV offers you a wide choice of programmes. Most of them are free, others are to be paid for by the viewer. This means that you will need to subscribe to the broadcasting organisation whose programmes you wish to receive. This organisation will supply you a corresponding decoder unit to allow the programmes to be unscrambled.

For further information ask your dealer. See also the booklet supplied with your decoder.

### Connect a decoder with an aerial socket to the TV

- Connect the aerial cable.

### Connect a decoder without an aerial socket to the TV

- Connect the decoder to your TV with a eurocable (RCA Jack Cable) to **EXTERNAL** (RCA Jack). When your decoder has a Euroconnector / RCA Jack you can obtain better picture quality if you connect a eurocable (RCA Jack Cable) to **EXTERNAL** (RCA Jack).

## TV and Video Recorder (VCR)

- Connect the Video Recorder to the ANT (antenna input) socket of the TV with the aerial cable.
- Connect the Video Recorder to the **EXT-1** terminal with the SCART cable, or connect it to the **EXT-2** terminal with the audio and video cables.

## NTSC Playback

Connect a NTSC video recorder to a terminal. Then press “**AV**” button to select the corresponding AV mode.

**NTSC 3.58/4.43** system is detected automatically in AV mode.

## Camera and Camcorder

### To connect to the EXT-2 terminal

Connect your camera or camcorder at the right side of your TV.

- Connect your equipment to the TV via **VIDEO** (yellow), **AUDIO R** (red) and **AUDIO L** (white) inputs. You should connect the jacks to the input in the same colour.

### Connect the decoder to the video recorder

Some video recorders have a special euroconnector for decoder.

- Connect a eurocable to the euroconnector of your decoder and to the special euroconnector of your video recorder. See also the handbook of your video recorder.
- To connect your video recorder to the TV, see TV and Video Recorder section.

If you want to connect more equipment to your TV, consult your dealer.

## Connecting Headphones

Use the stereo headphone socket at the right side of your TV, to connect headphones.

## Connecting the PC

Connect PC monitor with 15-pin PC cable to the 15-pin connector on the rear of the computer. For detail installation procedure see **Installation** in PC mode.

### To connect to S-Video input

Connect your camera or camcorder at the right side of your TV.

- Connect your equipment to the TV via S-Video input at the right side by using S-Video cables.

# Peripheral Equipment Connections

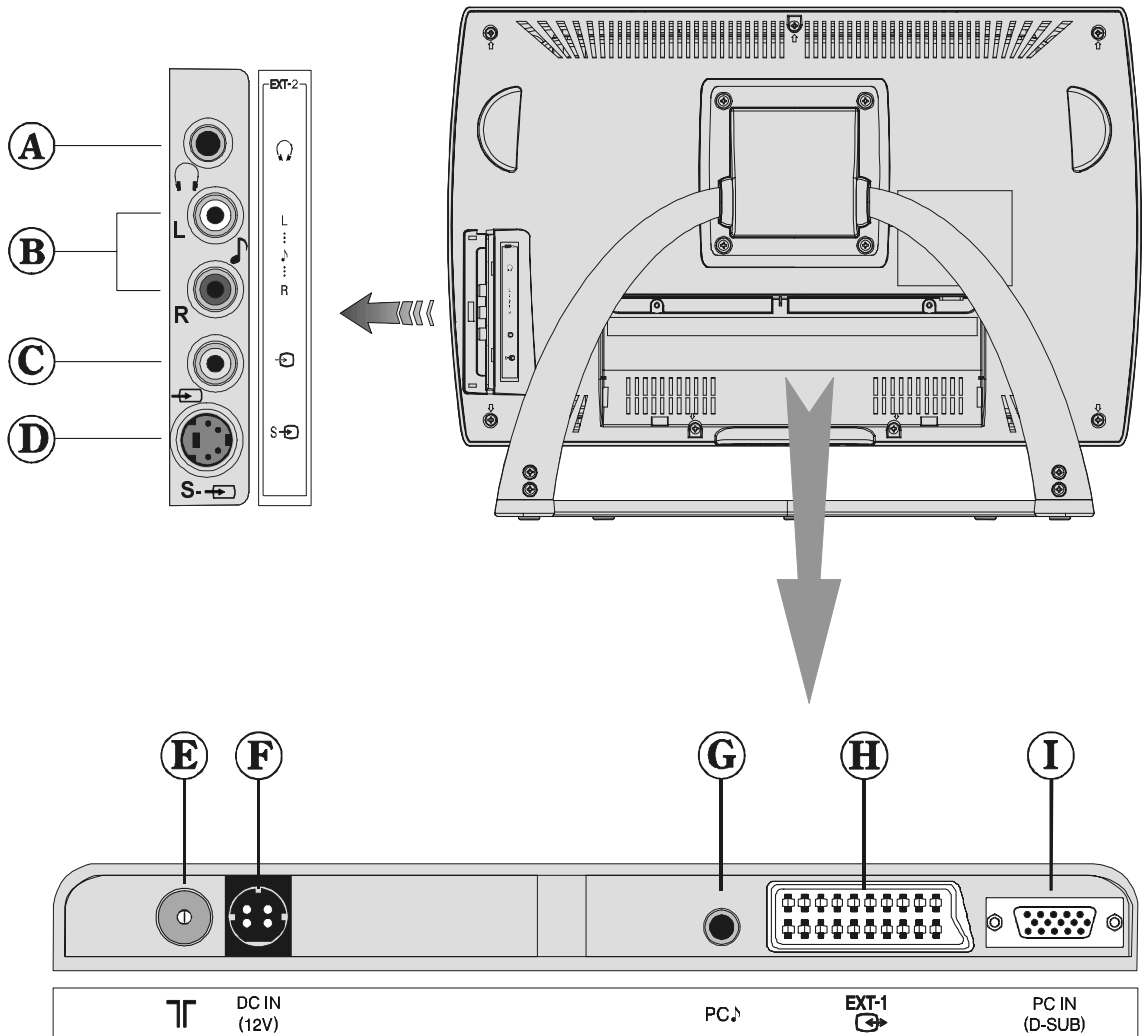

**(A) HEADPHONE**

**(B) AUDIO L/R**

**(C) VIDEO IN**

**(D) S-VIDEO IN**

**(E) ANTENNA**

**(F) DC IN (ADAPTOR)**

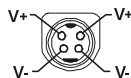

**(G) PC AUDIO IN**

**(H) EXT-1**

**(I) PC INPUT**

**EXT-2**



# Antenna Connections

## Outdoor Antenna Connections

VHF antenna

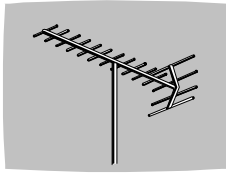

Round 75 ohm coaxial cable

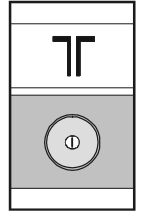

Rear of TV

VHF/UHF antenna

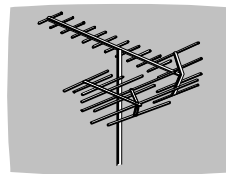

Flat 300-ohm twin lead cable

Round 75-ohm coaxial cable

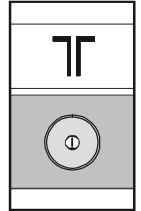

Rear of TV

## Peripheral Equipment Connections

HEADPHONE



AUDIO

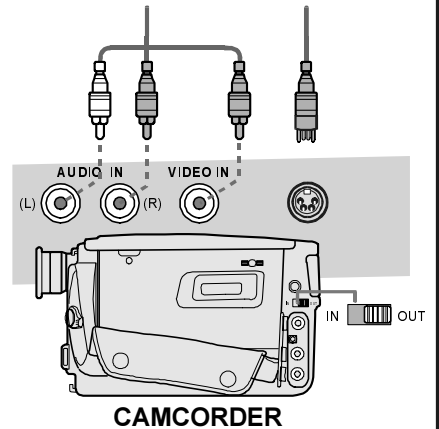
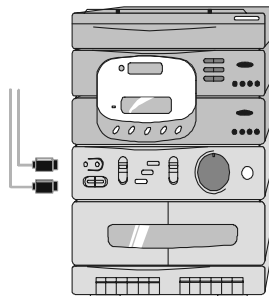

CAMCORDER

VIDEO

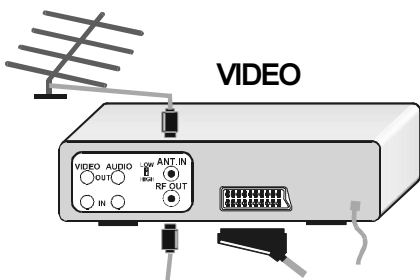

DECODER

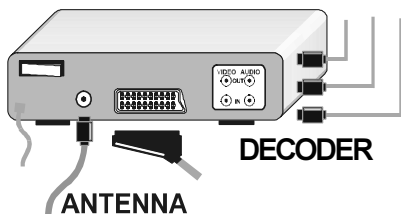

ANTENNA

FOR SATELLITE RECEIVER

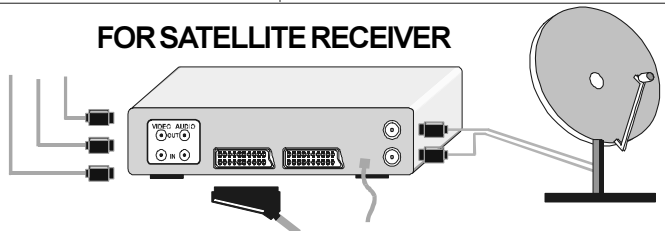

## PC Input Typical Display Modes

The display has a maximum resolution of 1024 x 768, vertical sync. frequency range of 50-72 Hz and a horizontal sync. frequency range of 30-57 KHz.

The following table is an illustration of some of the typical video display modes.

<i>Mode</i>	<i>Resolution</i>		<i>Frequency</i>	
	<i>Horizontal</i>	<i>Vertical</i>	<i>Hor. (kHz)</i>	<i>Ver. (Hz)</i>
1	640	480	31.5	60
2	640	480	37.9	72
3	800	600	35.2	56
4	800	600	37.9	60
5	800	600	48.1	72
6	1024	768	48.4	60
7	1024	768	56.5	70

The native resolution of the TFT-LCD Panel is 1024 x 768. Therefore using Mode 6 is advised to get the best PC input display quality.

## Tips

### Can not turn the TV on?

Check that TV/VCR/DVD switch is set to TV position.

TV may go to stand-by mode when you turn the TV on soon after you turn the TV off. If you can turn the TV on again, it is not a problem.

### Can not turn the TV off?

Check that TV/VCR/DVD switch is set to TV position.

### Care of the Screen

Clean the screen with a slightly damp, soft cloth. Do not use abrasive solvents as they may damage the TV screen coating layer.

### Colours of image on screen are abnormal

Have you selected the correct TV system? Is your TV set or house aerial located too close to the loudspeakers, non-earthed audio equipment or neon lights, etc. ?

Mountains or high buildings can cause double pictures or ghost images. Sometimes you can improve the picture quality by changing the direction of the aerial.

Is the picture or Teletext unrecognisable? Check if you have entered the correct frequency.

The picture quality may degrade when two peripherals are connected to the TV at the same time. In such a case, disconnect one of the peripherals.

### No Image on Display Screen

Is the aerial connected properly? Are the plugs connected tightly to the aerial socket? Is the aerial cable damaged? Are suitable plugs used to connect the aerial? If you are in doubt, consult your dealer.

**No Image** means that your TV is not receiving any transmission. Have you pressed the correct buttons on the remote control? Try once more.

## PC Picture

If no PC picture appears, check that the D-SUB cable is connected properly. Check that your PC's resolution set correctly. See **page 25** for supported modes.

## Sound

You can not hear any sound. Did you perhaps interrupt the sound, by pressing "~~X~~" button? Are external speakers connected to the TV?

Sound is coming from only one of the speakers. Is the balance set to one direction extreme? See **Sound** menu.

## Remote Control

If your TV no longer responds to the remote control, perhaps the batteries are exhausted. Replace the batteries.

Have you selected the wrong menu? Press "**MENU**" button to return to normal screen or press "**BACK**" button to return to the previous menu.

## No solution

Switch your TV set off and on. If this does not work, switch off, remove the mains plug and call the service personnel; never attempt to repair it yourself.

# Specifications

Item	Model	LT-15B60SE
Broadcasting Systems		PAL SECAM BG, DK, I, L, Lp
Channels and Frequencies		VHF (VL) : 46,25 MHz - 168,25 MHz VHF (VH) : 175,25 MHz - 463,25 MHz UHF : 471,25 MHz - 863,25 MHz Cable TV : (S1-S20/ S21-S41)
Input Signal		<b>Video:</b> Analog 0,7 Vp-p 75 ohm positive <b>Sync:</b> TTL Level positive or negative, Seperate sync.
Horizontal Timing		30 - 69 KHz
Vertical Timing		50 - 75 Khz
Dot Rate		78,75 MHz max.
Panel Size		15" (381 mm) (measured diagonally)
Visible Picture Size		304 mm horizontal x 228 mm vertical
Display Resolution		1024 x 768 max. (XGA)
Number of Preset Channels		100
Channel Indicator		On Screen Display (OSD)
RF Aerial Output		75 Ohm (unbalanced)
Power Requirements		<b>Adaptor:</b> 100-240 V AC, 50 Hz / <b>TV:</b> 12 V DC
Power Consumption (W)		41 W (max) / STAND-BY <3W
Sound Systems		German , Nicam Stereo
Audio Output		2 x 3 W <sub>RMS</sub> (%10 THD)
EXT-1 Terminal		Euroconnector (21-pin, SCART 1) (back of the cabinet) • Video Input, S-Video (Y/C) input, Audio L/R Inputs and RGB inputs are available. • TV broadcast outputs (Video and Audio L/R) are available.
EXT-2 Terminal		RCA connectors x 3 (side of the cabinet) S-VIDEO connector x 1 (side of the cabinet) • Video input, S-VIDEO (Y/C) input and Audio L/R inputs are available.
PC IN terminal		Analog RGB D-SUB 15 x 1 • PC signal is available (refer to <b>page 25</b> for details of the signals which can be input)
PC AUDIO IN terminal		Stereo mini-jack (3.5 mm diameter)
Dimensions (W x H x D)		489 mm x 353 mm x 183 mm 489 mm x 304 mm x 62 mm (TV only)
Weight		7,5 kg (with stand) / 6,0 kg (TV only)
Accessories		Remote control unit x 1 (RM-C1861) / AA/R6 dry cell battery x 2 AC adaptor x 1 Power cord x 1
Headphone jack		Stereo mini-jack (3.5 mm diameter)