

Connections

Adjust the volume level:

- middle volume level for the CD player
- as desired for the car audio system

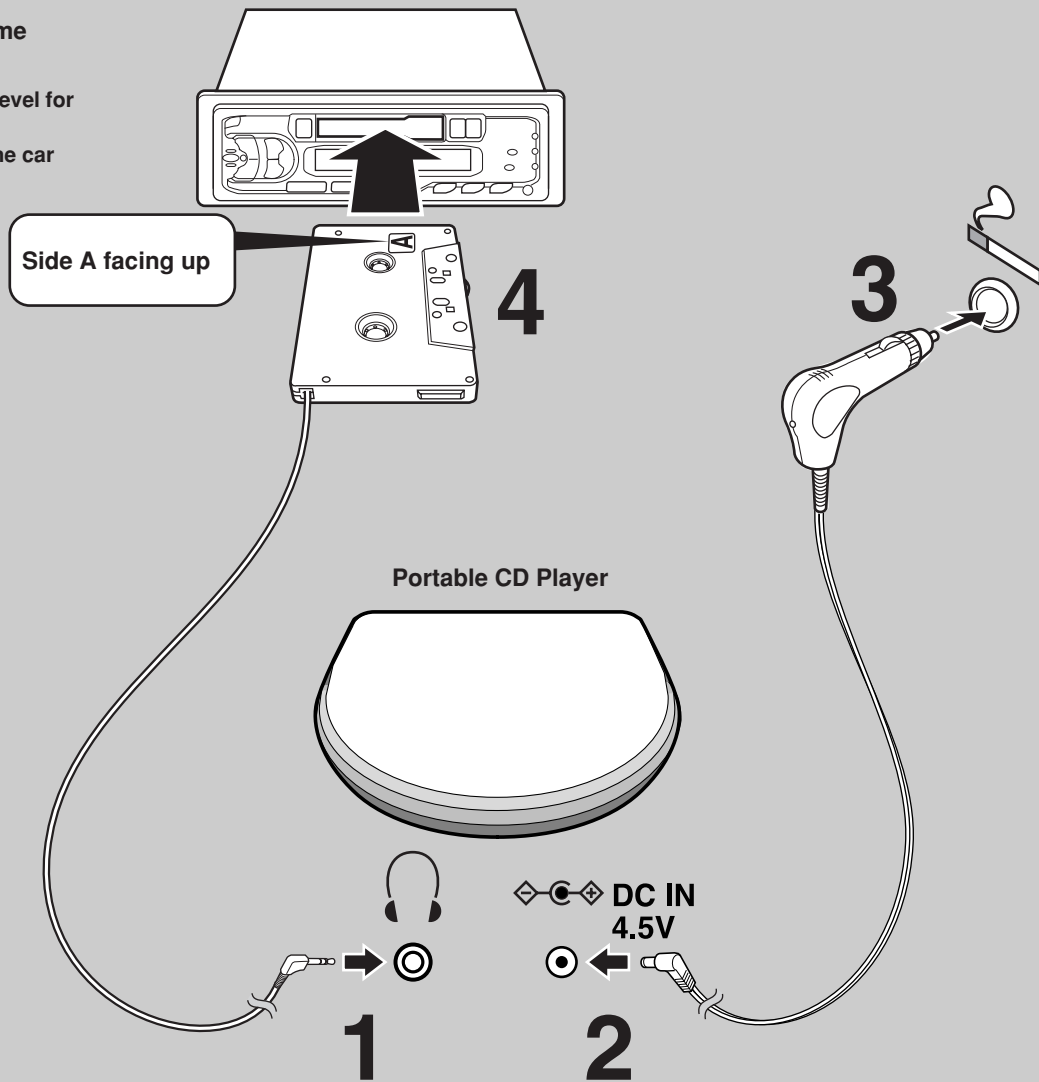

JVC



CAR KIT

INSTRUCTIONS

Accessories Supplied For Installation

- Car audio cassette adaptor (CA-RC7) 1 pc.
- Car adaptor (CA-R456 or CA-R457) 1 pc.

Thank you for purchasing this JVC product. Please read these instructions carefully before starting operation to be sure to obtain optimum performance and a longer service life from the unit.

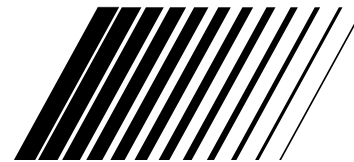

EN
©2003 VICTOR COMPANY OF JAPAN, LIMITED

LVT1182-007A [B, UJ]
1203SKMCREORI

Before installing this product, please read these instructions completely. Please save this manual.
Before installing this cassette adaptor in the car, check whether it can be fitted into your car audio unit.
The cassette adaptor cannot be used with some car audio system.
The cassette adaptor is shown in the illustrations of the car audio adaptor.

Concerning the Car Audio System

Position the cassette adaptor with side A facing up and set the play direction for the car audio system to the forward (FWD) direction.
The head positions of the cassette adaptor and the car audio system do not match in the reverse direction, causing the sound volume from the speakers to be extremely low.

For a car audio system with the head at the right side

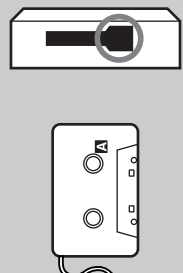

For a car audio system with the head at the left side

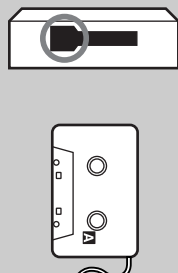

For a car audio system in which the head is in the center at the rear

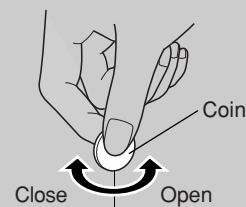
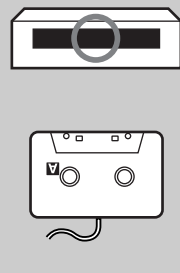

For a car audio system with the head at the left side

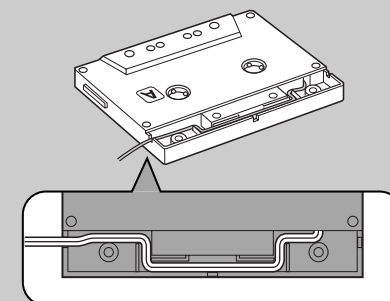

For a car audio system in which the head is in the center at the rear

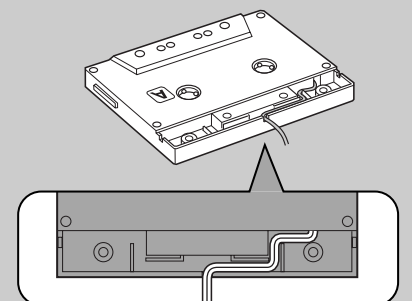

Car audio system

■ When the car audio system has a blank skip function

The blank skip function may operate when the CD player stops. Therefore, be sure to set the blank skip function to off.

Note:

Depending on the type of vehicle, static may be heard if the unit is connected via line cord to the car audio system's AUX jack. If this occurs, it is recommended that you use the provided cassette adaptor.

When you leave the car

Push the eject button to remove the cassette adaptor.

Car adaptor

The provided car adaptor must be connected.

- This car adaptor can be used in an automobile which has a 12 V battery. (This is a negative ground car adaptor.)
- Do not connect the adaptor immediately after using the cigarette lighter.
- Leave a little slack in the car adaptor's cord, making sure that it does not run underneath the unit.

■ To replace the fuse

1 Remove the plug cap by rotating it in the direction shown by the arrow, and take out the old fuse.

2 Insert the new fuse (250 V, 1 A type) into the fuse receptacle and reinstall the plug cap.

Note:

For continued protection against risk of fire, replace only with same type 250 V, 1 A fuse.

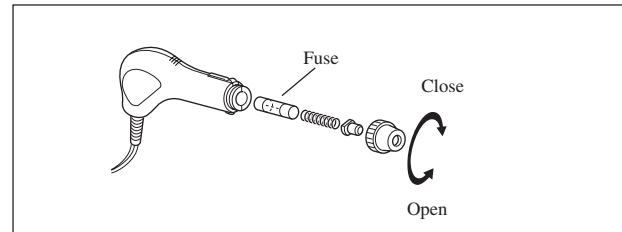

If the fuse blows frequently, there may be something wrong with the adaptor. Consult your dealer.

Troubleshooting Guide

Before requesting service for this unit, check the chart below for a possible cause of the problem you are experiencing. Some simple checks or a minor adjustment on your part may eliminate the problem and restore proper operation.

If you are in doubt about some of the check points, or if the remedies indicated in the chart do not solve the problem, refer to the directory of Authorized Service Centers (enclosed with this unit) to locate a convenient service center, or consult your dealer for instructions.

Problem	Checkpoint	Remedy
The sound volume is extremely low.	Did you adjust the volume level of the unit?	Adjust the volume level of the unit to middle or higher.
	Did you adjust the volume level of the car audio system?	Adjust the volume level of the car audio system to the desired level.
	Does the car audio system have an auto-reverse function?	Set the play direction for the car audio system to the forward (FWD) direction. [The forward (FWD) direction is the side which produces sound or which has the greatest sound volume.]
The cassette adaptor cannot be inserted into the car audio system.	Did you check the position of the car audio's head?	Check the position of the head in relation to the car audio system to ensure the cassette adaptor is installed correctly.
The unit cannot be turned on.	Is the fuse for the car adaptor blown?	Insert a new fuse.

Cautions

Please understand that we cannot take responsibility for the unit falling or any other damage that may occur as a result of faulty installation.

■ Car adaptor

- The provided car adaptor is made specifically for use with DC 4.5V JVC portable CD players. Do not use it with other devices.
- Do not use the adaptor for a long period with the batteries left in the unit because this may shorten the life of the batteries.
- Pay attention to the car battery capacity when using this adaptor for a long period.
- Do not expose this adaptor to strong sunlight or very high temperatures.
- Be sure to remove this adaptor from the cigarette lighter socket when not using this adaptor or before leaving the automobile.
- The power source polarities of this unit are $\diamond \ominus \diamond$, check the DC IN jack.

■ Cassette adaptor

- Bunch the excess cord together or place it so that it will not interfere with operation.
- Do not touch the head or roller.
- A protective film has been placed over the heads to prevent them from being damaged. Do not remove this film.

- Ⓐ Protective film
- Ⓑ Head
- Ⓒ Roller

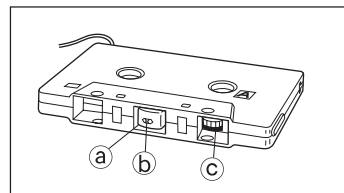

- After use, remove the cassette adaptor and keep it so that no dust will adhere to the head section.

- After installing the cassette adaptor in the car audio system, do not allow its cord to make contact with the control section.
- The sound quality deteriorates when the head section of the car audio system becomes dirty. It is, therefore, a good idea to clean it periodically.
- Do not leave this adaptor in a vehicle which is exposed to direct sunlight.
- Do not bring any magnetized objects near this adaptor's head position.
- Because of the nature of its construction, the sound of something rotating can be heard in this adaptor. This is normal and not indicative of a malfunction.
- During the winter months when the temperature inside the vehicle falls to an extremely low level, there may be times when the unit cannot be used because the cord is too stiff to allow the adaptor to be installed in its proper position.
- If the pinch rollers or car audio capstan are dirty, it may not longer be possible to install the cassette adaptor in the car audio system. Clean the rollers and capstan using a cotton swab.
- If the rollers are dirty, clean them using a cotton swab.

Specifications

■ Cassette adaptor

Frequency response.....125 Hz- 10 kHz
(This is the rating for the head section of the product.)
Dimensions (W × H × D)
.....90 mm × 40 mm × 26 mm
.....102.4 mm × 12.1 mm × 63.8 mm
Mass 48 g
Cable length.....Approx. 1 m

■ Car adaptor

Input.....DC 12 V
Output.....DC 4.5 V (600 mA)
Dimensions (W × H × D)
.....90 mm × 40 mm × 26 mm
Cable length.....More than 1.4 m

Note:

Specifications are subject to change without notice.
Mass and dimensions are approximate.