

Haier®

OWNER'S MANUAL

LE32A300/LE42A300/LE55A300

LB32R3A/LB42R3A/LB46R3A/LB55R3A

LE32H300/LE42H300/L32K3/L42K3



LED-LCD TELEVISION

Please READ this manual carefully before operating your TV, and retain it for future reference.

Contents

Warning	3	Function Menu	18
Important Safety Instructions	4	Function Menu Set	18
Introduction	6	Adjust Menu	19
Panel Control	6	Time Menu	19
Connection Options	7	Lock Setup	20
Remote Control	8	How to use the password function	20
Battery loading	8	Streaming Media Playing System	21
Precautions	8	Start/Exit Streaming Media Playing system	22
Remote Control Function	9	Operating Method of Streaming Media Menu	22
Function introduction	9	Playing a Picture	22
External Equipment Connections	10	Playing a Movie	23
Antenna Connection	10	Playing Music	23
Choose Your Connection	11	Text	23
VCR Connection	11	Settings	23
External AV Source Setup	11	Maintenance	24
Connecting a DVD player	11	Troubleshooting	24
HDMI or DVI Setup	12	Specification	25
PC Setup	12	Format	25
Monitor Out Setup	13		
Power source	13		
Basic Receiving and Playing Operations	14		
Switching ON/OFF the TV set	14		
Switching ON/OFF the TV set	14		
Choose the Menu Language	14		
Choose the Input source	14		
Picture Menu	14		
How to select the picture mode	14		
How to customize your own picture status	15		
Sound Menu	15		
How to select the sound mode	15		
How to customize your own sound status	16		
Channel Menu	16		
Programme Edit	16		
Auto Tuning	17		
Exchange	17		

Warning

	WARNING RISK ELECTRIC SHOCK DO NOT OPEN	
<p>WARNING: TO REDUCE THE RISK OF ELECTRIC SHOCK DO NOT REMOVE COVER (OR BACK). NO USER SERVICEABLE PARTS INSIDE. REFER TO QUALIFIED SERVICE PERSONNEL.</p> <p>*To avoid electric hazards, it is strongly suggested that the back cover not be opened, as there is no any accessory inside the casing.</p> <p>* If necessary, please contact authorized after-sales services.</p> <p>* A lightning flash mark in a triangle: A potentially hazardous situation, which, if not avoided, could result in serious injury by high voltage.</p> <p>* An exclamation mark in a triangle: Major part or accessory of which technical specifications must be followed if it is to be replaced.</p>		

WARNING: To avoid fire or electric hazards, never place your television receiver in an area with heavy moisture. Attention should be paid to avoid accidental scratches or impacts onto the screen.

CAUTION: Please read this manual carefully before using your television and keep this manual in a good place for future reference.

To achieve the best performance of your television, read this User's Manual carefully and properly store it for future reference.

Information of screen displays and figures in the User's Manual may vary due to technical innovations.

CAUTION: Unauthorized disassembly of this product is prohibited.

Important Safety Instructions

The product should be tightly fixed to avoid drop damages and even fire.

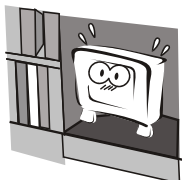

To avoid fire hazards, do not use this product under direct sunlight or closely to heat sources.

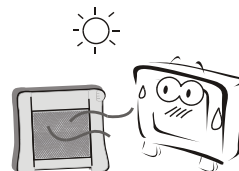

Do not locate the product close to water or oil, which may cause fire hazards.

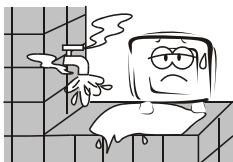

Unplug the power supply and antenna of the product when there is a rainstorm, especially Thunderstorm.



Do not use damaged or worn electric plugs, and keep electric cord away from heat sources to avoid electric shocks or fire hazards.



Do not connect excessive sockets in parallel or share the same socket by multiple plugs to avoid fire hazards.

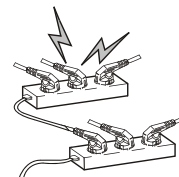

The product must be placed on a solid and stable surface to avoid collapse.

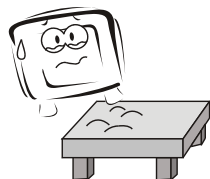

Unauthorized disassembly of the television is prohibited to avoid electric shocks or fire hazards. Contact authorized after-sales service if technical service is needed.

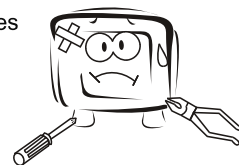

Keep the product away from a transformer or heat source to avoid fire hazards.

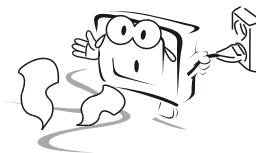
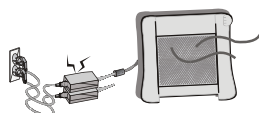

Disconnect the product from power supply and contact authorized after-sales service if abnormal sound is heard in the product.

Don't use or store inflammable materials near the product to avoid explosion or fire hazards.



Don't place the product in a humid area to avoid fire hazards.

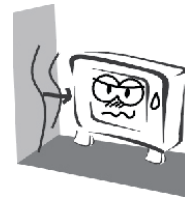

The antenna of the product should be away from electric cable to avoid electric shocks.

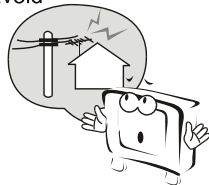

Never touch the plug when your hand is wet as this might cause electric shocks.

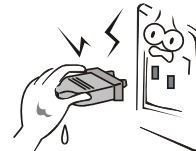

Always make sure that the television is well plugged as poor electric connection might cause fire.

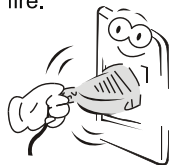

When antenna is used, measures should be taken to prevent water from flowing down along the cable into the television.



Unplug the television, use soft fabric, never chemicals, if you are going to make cleaning of the product. Make sure that no water drops in the product.

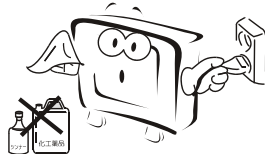

The plug and electric cable must be kept clean to avoid electric shocks or fire hazards.

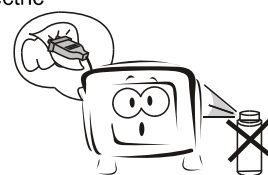

Disconnect the television from power supply and antenna when there is a rainstorm or thunderstorm to avoid electric shocks or fire hazards.



Disconnect the television from power supply to avoid electric shocks or fire hazards in a long vocation.

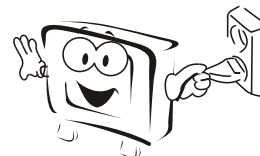

Introduction

- This is a simplified representation of front panel.
- Here shown may be somewhat different from your TV.

Panel Control

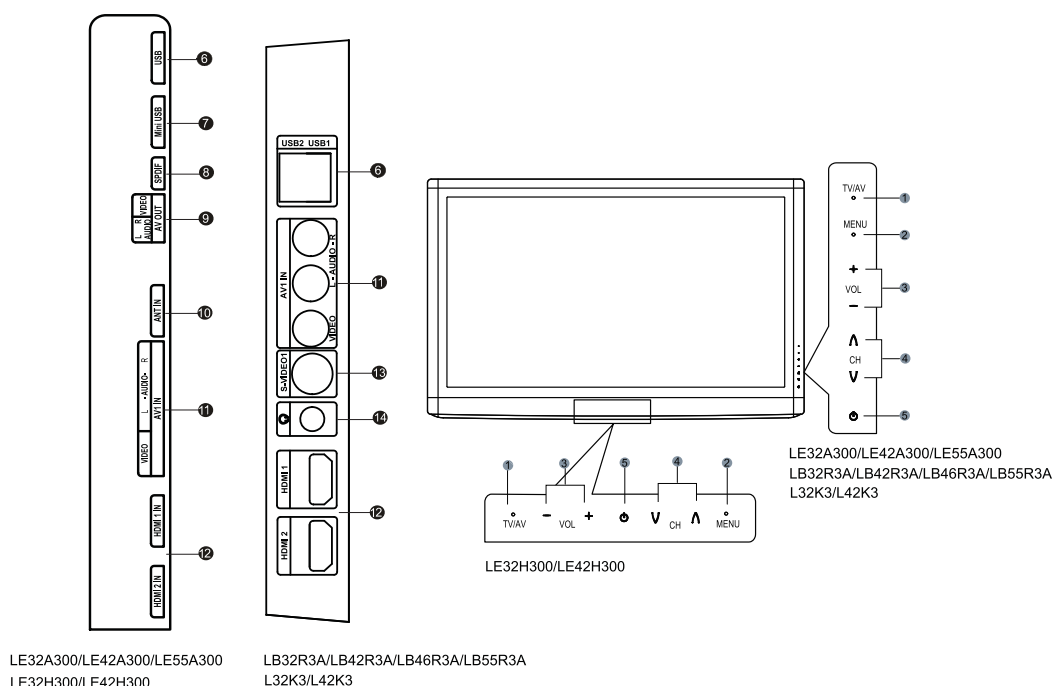

①	TV/AV	Press this key to open/close signal source options menu.
②	MENU	Menu display. Press to access the on-screen menu display.
③	VOL +/-	Press to adjust the volume. In the MENU screen, these buttons serve as right/left buttons.
④	CH +/-	Press to scan through channels. To scan quickly through channels, press and hold down either +/- . In the MENU screen, these buttons serve as up/down buttons.
⑤	POWER	Press to turn on and off the TV.
⑥	USB jack	Connect a USB flash drive to view videos, images or listen music.
⑦	Mini USB	Connect a USB flash drive to view videos, images or listen music.

⑧	SPDIF	Digital Audio Optical output.
⑨	AV OUT	Connect the audio L/R and video cables to your other video equipment.
⑩	ANT IN	Connect cable pr antenna signal to the TV, either directly or through your cable box.
⑪	AV1 IN	Connect the video signal from a video device.
⑫	HDMI IN	Connect a HDMI device to receive digital audio and uncompressed digital video.
⑬	S-VIDEO	Connect the S-VIDEO cable from an external signal source to this jack.
⑭	Headphone	Headphone audio output terminal.

Connection Options

Back panel connections

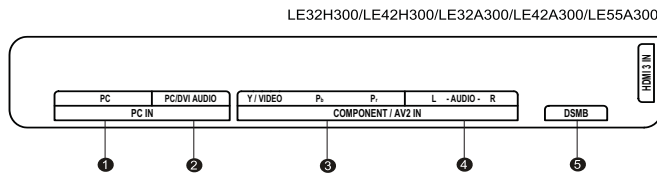
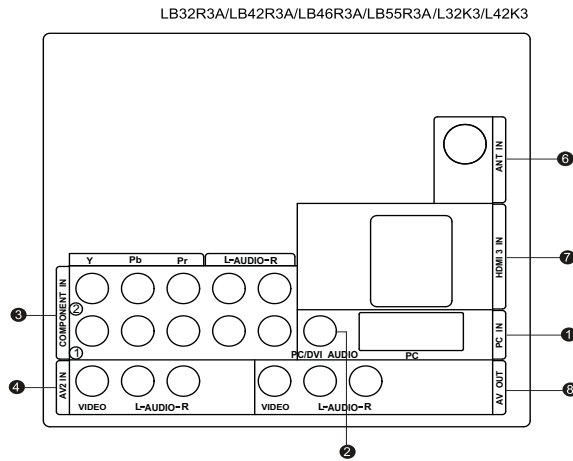

- ① **PC Video In** Connect a video cable from a computer to this jack..
- ② **PC/DVI Audio In** Connect the audio L/R cables from a computer to this jack.
- ③ **Component Video In** Connect a component video device to these jacks.
- ④ **AV2 In** Connect the video signal from a video device.
- ⑤ **DSMB** Mo-Box jack .
- ⑥ **ANT In** Connect cable pr antenna signal to the TV, either directly or through your cable box.
- ⑦ **HDMI 3 IN** Connect a HDMI device to receive digital audio and uncompressed digital video.

- ⑧ **AV OUT** Connect the audio L/R and video cables to your other video equipment.

Remote Control

Battery loading

1. Slide open the cover of the battery compartment on the back of the remote controller.
2. Load two 7# (AAA) alkaline batteries in the compartment, (plus and minus poles to respective mark)
3. Replace the cover of the battery compartment.

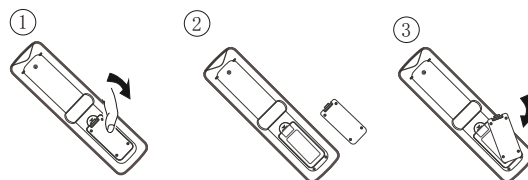

Precautions

As strong light may interfere the signals, change your position to operate the remote controller if the television cannot be turned on or off as you expect.

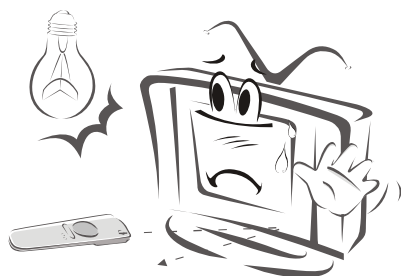

Keep the remote controller away from heat source or humid area to ensure effective performance of the remote controller.

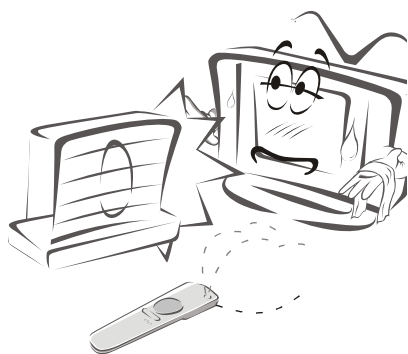

Make sure that two AAA alkaline batteries are loaded. The batteries must be of the same type. The batteries must be located properly. The batteries are not rechargeable.

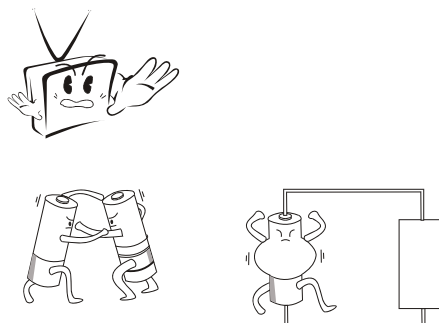

Make sure that there is no obstacle between the remote controller and television set.

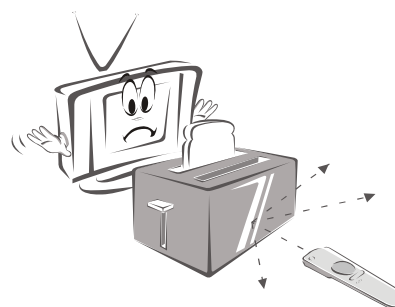

Remote Control Function

- The remote control cannot be operated unless the batteries are properly loaded.
- When using the remote control, aim it at the remote control sensor on the TV.

Function introduction

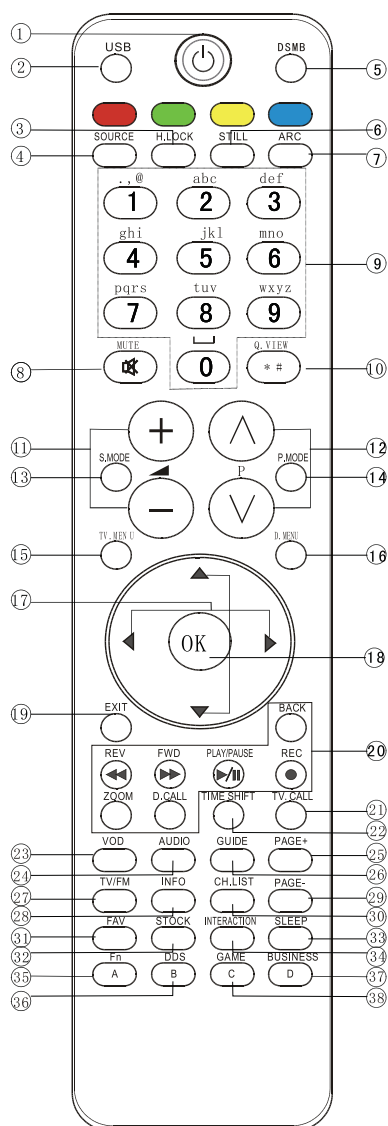

①	POWER	Press this key to start TV from standby mode, press it again to return to standby mode.
②	USB	Press this key for quick switching of streaming media.
③	H. LOCK	Refer to the Functional Description on Page 20.
④	SOURCE	Press this key to open/close signal source options menu.
⑤	DSMB	Press this key for quick switching of MO-Car.
⑥	STILL	Press this key to freeze the image. Press it again to return to normal screen. (Note: Do not display a still picture for a long time to prevent the screen from burns.)
⑦	ARC	Press this key to select the screen display proportion.
⑧	MUTE	Press this key to mute the sound, press it again to activate the sound. The sound may be activated by turning the TV on again or increasing the volume.
⑨	0-9	These keys are used to select a channel.
⑩	Q. VIEW	Press this key to return to the previous TV program(only work in the TV mode).
⑪	VOL+ /-	Used to adjust the volume when the screen menu is closed.
⑫	CH+/-	Used to select a TV channel when the screen options menu is closed, specifically, press P \wedge to decrease the channel and press P \vee to increase the channel..
⑬	Sound Mode	Press this key continuously to select the sound mode.
⑭	Picture Mode	Press this key continuously to select the picture mode.
⑮	TV.MENU	Press this key to display or exit the main menu.
⑯	D.MENU	Press this key to display the Special Function Menu (it functions when special modules are inserted).
⑰	THUMBSTICK (Up/Down/Left/Right)	Allows you to navigate the on-screen menus and adjust the system settings to your preference.
⑱	OK	Press this key to confirm the selection.
⑲	EXIT	Clears all on-screen displays and returns to TV viewing from any menu.
⑳	USB	Control the USB System. ◀ Backward ▶ Forward ▶ Play/Pause BACK: Back REC: no available ZOOM: Press to magnify/minify an image D.CALL: Press to display program information.
㉑	TV.CALL	Display on/off.
㉒	TIMESHIFT	No available.
㉓	VOD	No available.
㉔	AUDIO	No available.
㉕	PAGE+	No available.
㉖	GUIDE	No available.
㉗	TV/FM	No available.
㉘	INFO	No available.
㉙	PAGE-	No available.
㉚	CH.LIST	No available.
㉛	FAV	Press this key to display the favorite program list menu.
㉜	STOCK	No available.
㉝	SLEEP	Displaying the sleep time.
㉞	INTERACTION	No available.
㉟	Fn	No available.
㊱	DDS	No available.
㊲	BUSINESS	No available.
㊳	GAME	No available.

External Equipment Connections

Antenna Connection

- Antenna or Cable Service without a Cable Box Connections.
- For optimum picture quality, adjust antenna direction if needed.

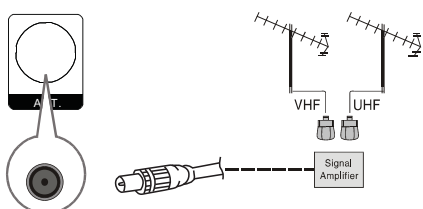
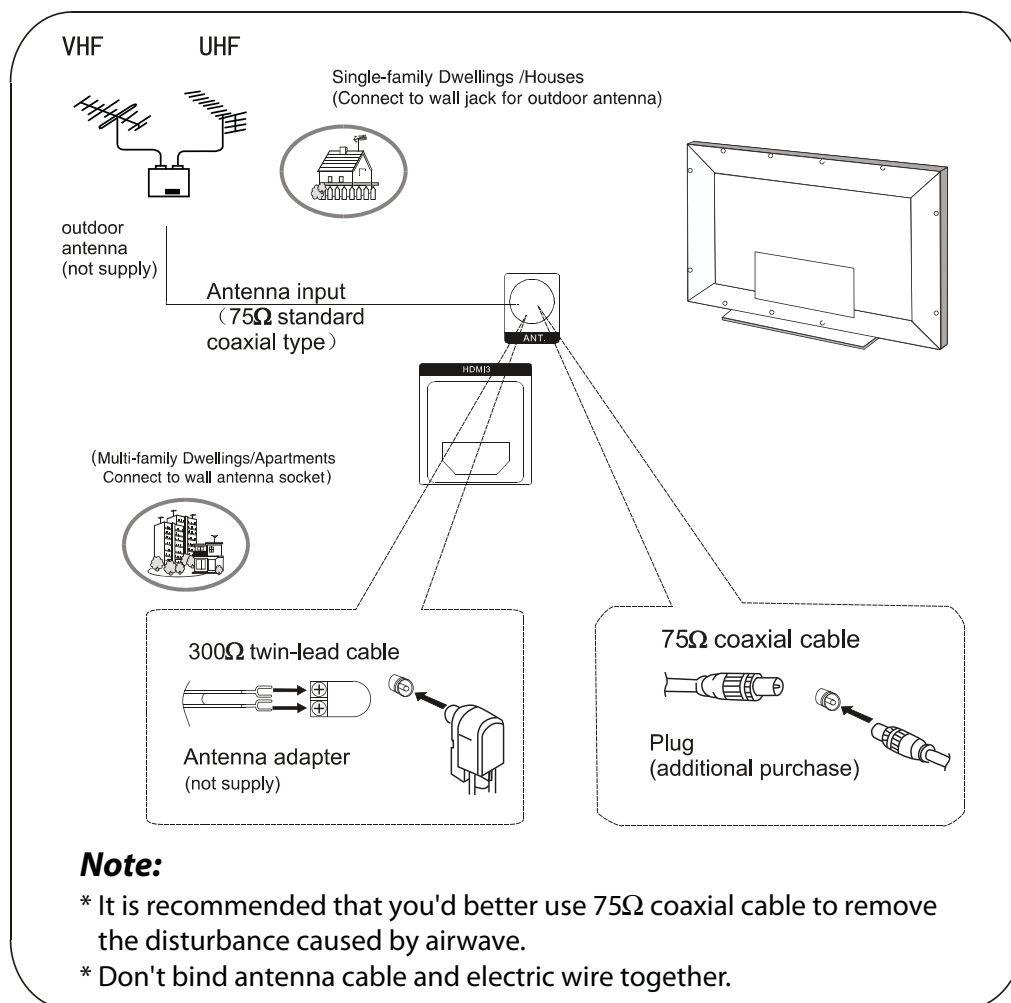

- To improve picture quality in a poor signal area, purchase and install a signal amplifier.
- If the antenna needs to be split for two TV's, install a "2-WaySignal Splitter" in the connections.
- If the antenna is not installed properly, contact your dealer for assistance.

Note

- All cables shown are not included with the TV.

Choose Your Connection

There are several ways to connect your television, depending on the components you want to connect and the quality of the signal you want to achieve. The following are examples of some ways to connect your TV. Take LE32A300 as an example, Choose the connection which is best for you.

VCR Connection

To avoid picture noise (interference), leave an adequate distance between the VCR and TV.

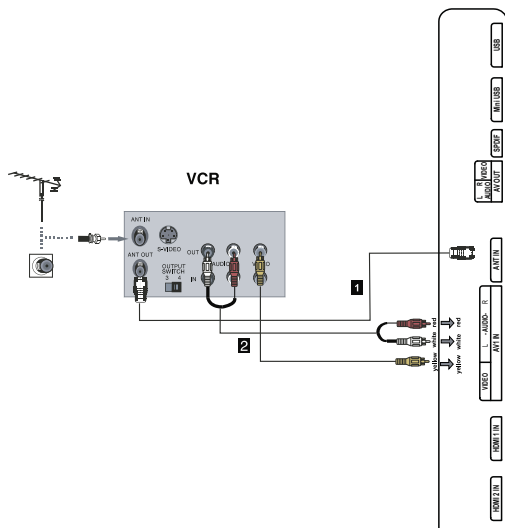

Connection Option 1

Set VCR output switch to channel 3 or 4 and then tune the TV to the same channel number.

Connection Option 2

- 1** Connect the audio and video cables from the VCR's output jacks to the TV input jacks, as shown in the figure. When connecting the TV to VCR, match the jack colors (Video = yellow, Audio Left = white, and Audio Right = red).
- 2** Insert a video tape into the VCR and press **PLAY** on the VCR. (Refer to the VCR owner's manual.)
- 3** Select the input source with using the **SOURCE** button on the remote control, and then press **◀ / ▶** button to

select the source, press the **OK** button to confirm.

External AV Source Setup

How to connect

- Connect the audio and video cables from the external equipment's output jacks to the TV input jacks, as shown in the figure.
- When connecting the TV to external equipment, match the jack colors (Video = yellow, Audio Left = white, and Audio Right = red).

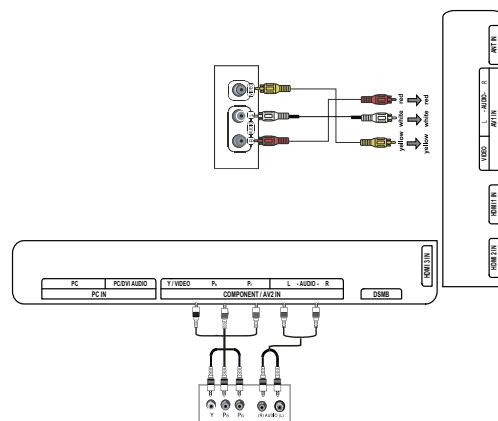

How to use

- 1** Select the input source with using the **SOURCE** button on the remote control.
- 2** Press **◀ / ▶** button to select the desired source.
- 3** Press **OK** button to confirm.
- 4** Operate the corresponding external equipment.

Connecting a DVD player

How to connect

- 1** Connect the DVD video outputs (Y, P_b/C_b, P_r/C_r) to the COMPONENT (Y, P_b/C_b, P_r/C_r) input jacks on the TV and connect the DVD audio outputs to the AUDIO jacks on the TV as shown in the figure.

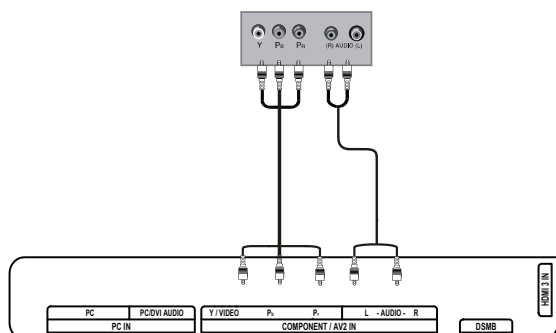

How to use

- 1 Turn on the DVD player, insert a DVD.
- 2 Use the **SOURCE** button on the remote control, and then press ◀ / ▶ button to select COMPONENT mode, press the **OK** button to confirm.
- 3 Press **Play** button on external equipment for program play.
- 4 Refer to the DVD player's manual for operating instructions.

HDMI or DVI Setup

To watch digitally broadcast programs, purchase and connect a digital set-top box.

How to connect

- Use the TV's COMPONENT (Y, Pb/Cb, Pr/Cr) INPUT jacks, VGA or HDMI port for video connections, depending on your set-top box connections available. Then, make the corresponding audio connections.

How to use

- 1 Turn on the digital set-top box. (Refer to the owner's manual for the digital set-top box.)
- 2 Use SOURCE on the remote control to select PC or HDMI (Y, Pb/Cb, Pr/Cr) mode.
- 3 Press **Play** button on external equipment for

program play.

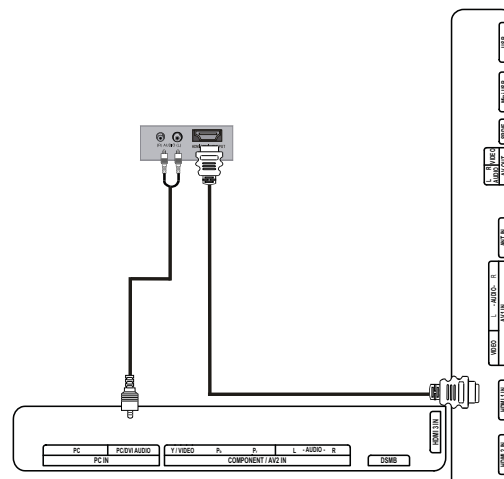

PC Setup

How to connect

- 1 Use the TV's PC IN port for video connections.
- 2 Then, make the corresponding audio connection. If using a sound card, adjust the PC sound as required.

How to use

- 1 Turn on the PC and the TV.
- 2 Turn on the display by pressing the **POWER** button on the TV's remote control.
- 3 Use SOURCE on the remote control to select PC source.
- 4 Check the image on your TV. There may be noise associated with the resolution, vertical pattern, contrast or brightness in PC mode. If noise is present, change the PC mode to another resolution, change the refresh rate to another rate or adjust the brightness and contrast on the menu until the picture is clear. If the refresh rate of the PC graphic card can not be changed, change the PC graphic card or consult the manufacturer of the PC graphic card.

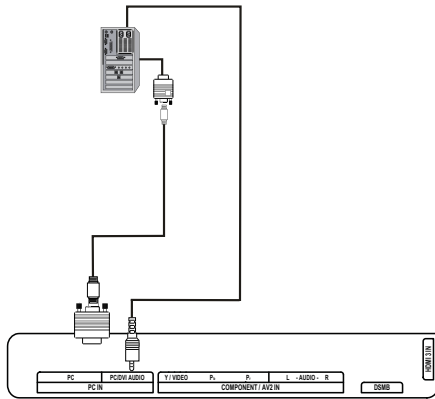

Note

- ❑ Avoid keeping a fixed image on the TV's screen for along period of Time. The fixed image may become permanently imprinted on the screen.
- ❑ The synchronization input form for Horizontal and Vertical frequencies is separate.
- ❑ To obtain the best picture, do not play the USB, YP_bP_r, HDMI or PC source at the same time.

Monitor Out Setup

The TV has a special signal output capability which allows you to hook up a second TV or monitor.

Connect the second TV or monitor to the TV's AV OUT by the tie line. See the Operating Manual of the second TV or monitor for further details regarding that device's input settings.

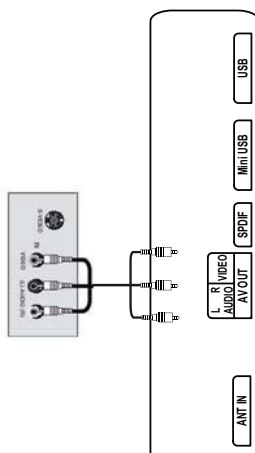

Note

- ❑ Component, PC, HDMI input sources cannot be used for Monitor out.
- ❑ When connecting with external audio equipments, such as amplifiers or speakers, please turn the TV speakers off.

Power source

TO USE AC POWER SOURCE

Use the AC polarized line cord provided for operation on AC. Insert the AC cord plug into a standard polarized AC outlet.

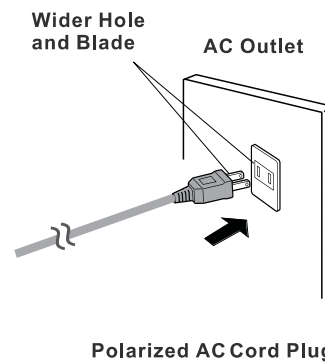

Note

- ❑ Never connect the AC line cord plug to other than the specified voltage. Use the attached power cord only.
- ❑ If the polarized AC cord does not fit into a non polarized AC outlet, do not attempt to file or cut the blade. It is the user's responsibility to have an electrician replace the obsolete outlet.
- ❑ If you cause a static discharge when touching the unit and the unit fails to function, simply unplug the unit from the AC outlet and plug it back in. The unit should return to normal operation. Polarized AC Cord Plug.

Basic Receiving and Playing Operations

Switching ON/OFF the TV set

In the manual, the OSD (on screen display) may be different from your TV's because it is just an example to help you with the TV operation.

Switching ON/OFF the TV set

- 1 First, connect power cord correctly and the power indicator will light.
- 2 Press **POWER** on the remote control again.
- 3 If you want to exchange to standing by status, please press down **POWER** on the remote control
- 4 Disconnect the power supply or unplug the television if it is intended to completely cease the television performance.

Choose the Menu Language

When you satisfied with your set for the first time, you must select the language which will be used for displaying menus and indications.

- 1 Press **MENU** and **▲ / ▼** to select **Function** menu.
- 2 Press **◀ / ▶** button to select **language** option.
- 3 Select a particular language by pressing **OK** repeatedly.
- 4 When you satisfied with your choice, press **MENU** to return to normal viewing.

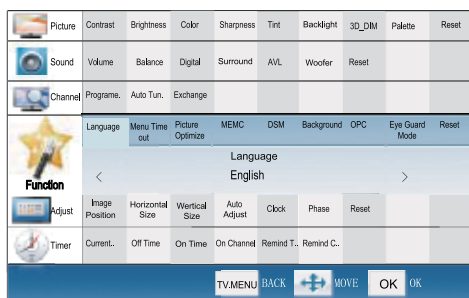

Choose the Input source

Change the picture source so you can watch your TV, VCR, Cable , or any other devices that are connected to your TV.

- 1 Press **SOURCE** button to enter the Input Source menu and then use **◀ / ▶** button to select the desired items (TV, AV1, AV2, Component, PC, HDMI1, HDMI2, HDMI3, Multimedia).
- 2 Press **OK** button to confirm .

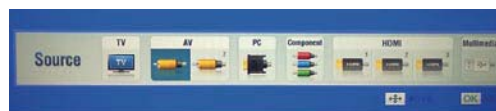

Picture Menu

The TV menu gives you an overview of the menus you can select.

Note

- Depending on the input signal, one or more menu items may not be selectable.

How to select picture mode

The picture mode provides the pre-defined images settings: Standard, Mild, User, Dynamic and EyeGuard .

You can press **P.MODE** button on the remote control to select the option Standard, Mild, User, Dynamic and EyeGuard.

How to customize your own picture status

- 1 Press **MENU** button and then use **▲ / ▼** button to select **Picture** menu.
- 2 Press **◀ / ▶** button to select the desired items, press **OK** to enter its submenu.
- 3 Press **◀ / ▶** button to adjust the setting.

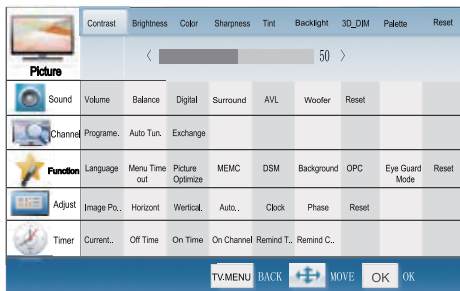

□ Contrast

This will adjust the intensity of bright parts in the picture but keep the dark parts unchanged.

□ Brightness

This will adjust the light output of the complete picture, which will mainly affect the darker areas of the picture.

□ Color

This will adjust the saturation level of the colors to suit your personal preference.

□ Sharpness

This will adjust the sharpness of fine details in the picture.

✎ Note

- The picture options can only be adjusted in the User mode. The other picture modes are preset.

□ Tint

Allows you to select the color mix (Tint) of the picture.

□ Backlight

press **◀ / ▶** to adjust the backlight(0-----10).

□ 3D_DIM

Select the 3D-DIM Demo or 3D-DIM Calibration, Press **OK** to set.

□ Palette:

Press **◀ / ▶** to select the Palette option, and then press **OK** to enter its submenu, and finally press **▲ / ▼** to select a toner pattern from six patterns (Cool2, Cool1, Standard, Warm1, Warm2, User) to your color preference. Normally, the Standard mode is selected.

If the User mode is selected, press **◀ / ▶** to enter the palette menu, (as shown in the below figure), and then press **◀ / ▶** to select a benchmark in the range of 2500K~15000K from warm color to cold color, afterwards press **▲ / ▼** to adjust; if a different benchmark is selected for adjustment, the original adjustment data will be automatically cleared.

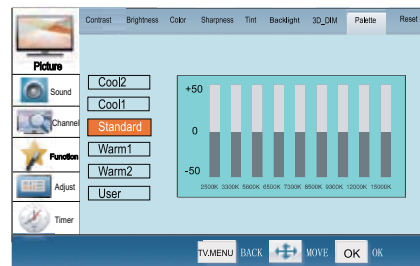

□ Reset

Press **◀ / ▶** to select **OK** or **Cancel**.

Sound menu

How to select sound mode

- 1 Press **MENU** button and then use **▲ / ▼** button to select **Sound** menu.
- 2 Press **◀ / ▶** button to select **Digital tone Mode**, press **OK** to enter its submenu.

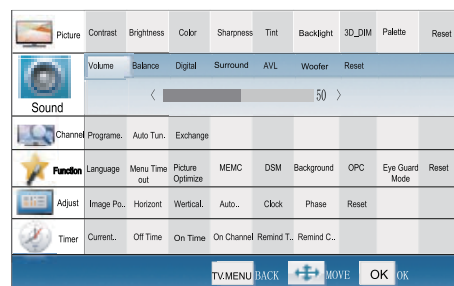

- 3 Press **▲ / ▼** button to select the option **Standard**, **Music**, **Movie** and **User**.

- You can also press **S.MODE** button on the remote control to select the Audio Mode: Standard, Music, Movie and User.

How to Customize your own sound status

- Press **MENU** button and then use **▲ / ▼** button to select **Sound** menu.
- Press **◀ / ▶** button to select the desired items, press **OK** to enter its submenu.
- Press **◀ / ▶** button to adjust the setting.

Volume

Press **◀ / ▶** to adjust the volume of a TV Program.

Balance

This will adjust the output of the right and left speakers to obtain the best stereo reproduction for your listening position.

The intermediate value is 0. When indication value of Balance increases toward 50, sound of the right and left speakers becomes stronger and weaker, respectively. When indication value of Balance decreases toward -50, sound of the right and left speakers becomes weaker and stronger.

Digital tone

This select the modes for sound reproduction dependent on the broadcast signals or signals from external inputs received.

Select the mode of sound (User/Standard/Music/Movie). If the User mode is selected, press **◀ / ▶** to select a benchmark in the range of 50~15K from bass to treble, afterwards press **▲ / ▼** to adjust, if a different benchmark is selected for adjustment, the original adjustment data will be automatically cleared.

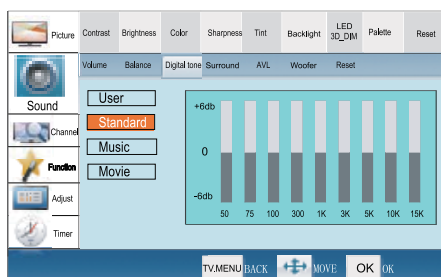

Surround

The surround sound feature expands the audio listening field wider and deeper to create exceptional sound quality from the TV's speakers.

AVL (Automatic Volume Limit)

This will reduce the differences in volume level among broadcasters.

Woofers

To adjust the super bass. Press **◀ / ▶** to select super bass off, low, high or Middle.

Reset

Return to factory default settings.

Channel menu

Display channel menu by pressing **SOURCE** button then use **◀ / ▶** button to select the source of TV item.

- Press **MENU** button and then use **▲ / ▼** button to select **Channel** menu.

- Press **◀ / ▶** button to select the desired items, press **OK** to enter its submenu.

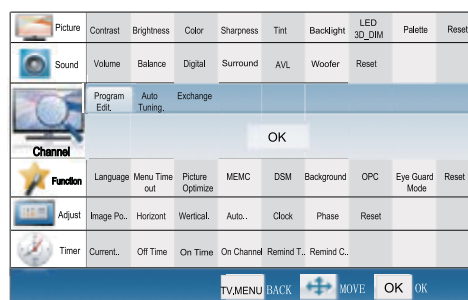

Programme Edit

You can add a label to a channel to make it easier to find.

- Press **MENU** button and then use **▲ / ▼** button to select **Channel** menu.

- Press **◀ / ▶** button to select the **Programme Edit**, and then press **OK** to enter submenu.

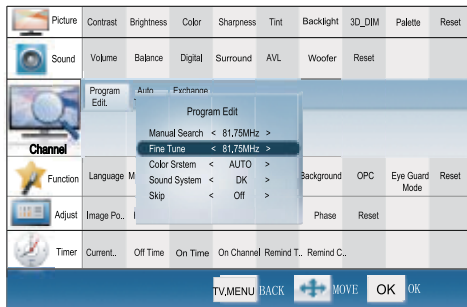

Manual Search

Press $\blacktriangle / \blacktriangledown$ to select the Search option, and finally press $\blacktriangleleft / \blacktriangleright$ to start manual search. Upon finding a program, the search will automatically stop, and the program will be stored onto the current channel. You may stop the search by pressing **OK** or **MENU**.

Fine Tune

Press $\blacktriangle / \blacktriangledown$ to select the Fine Tune option, and then press $\blacktriangleleft / \blacktriangleright$ to start UP or DOWN fine tuning until obtaining a relatively good picture effect. The fine tuning function is for the purpose of improving picture effect through fine tuning when that of a certain program is not good enough. Normally, the optimal picture effect can be obtained without fine tuning when watching TV programs, and fine tuning is to meet the need of adjusting a certain program.

Color system

Press $\blacktriangle / \blacktriangledown$ to select the Color Systems option, and then press $\blacktriangleleft / \blacktriangleright$ to select correct color system.

The TV is designed with three systems for your choice, i.e. Auto, PAL, SECAM and NTSC. Generally, the system is set as Auto and it is not necessary to make an adjustment. The system is normally set as Auto during auto search.

Sound system

The TV is designed with four systems for your choice, i.e. DK, M, BG and I. Generally, it is not necessary to adjust the system. The system is normally set as DK during auto search.

Skip

When the skip is set ON, the channel will be skipped when pressing **CH** \wedge or **CH** \vee and only can be selected by pressing 0-9 numerical keys.

If you want to recover the skipped channel

1. Use Direct-digit Choosing button to select the number of the channel to be recovered.
2. Do the above steps again.
3. Press $\blacktriangleleft / \blacktriangleright$ to set **Skip** as Off.

Auto Tuning

- 1 Press **MENU** button and then use $\blacktriangle / \blacktriangledown$ button to select **Channel** menu.
- 2 Press $\blacktriangleleft / \blacktriangleright$ button to select **Auto Tuning**, then press **OK** the menu opens.

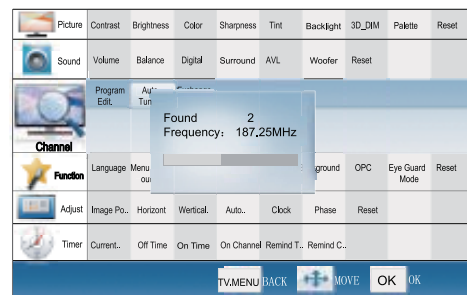

- 3 Press $\blacktriangleleft / \blacktriangleright$ button to select **OK**, press **OK** button on the remote to start to scan. Press **MENU** button to return to the previous menu, press **EXIT** button to EXIT the menu screen.

All channels now available will be automatically preset in order. After the search has finished, the first program number will display on the screen.

This search automatically adds only the active channels in your area to the TV's memory.

It deletes any channels on which there is no broadcast or a poor signal.

The channels found are automatically saved.

Exchange

- 1 Press **MENU** on the remote control unit or **MENU** on the TV's front panel to display main menu, and then press $\blacktriangle / \blacktriangledown$ to select **Channel** menu.
- 2 Press $\blacktriangleleft / \blacktriangleright$ to select the Prog. Exchange option, and then press **OK** to enter its submenu.
- 3 Press $\blacktriangle / \blacktriangledown$ to select the To Channel option, and then press $\blacktriangleleft / \blacktriangleright$ to set the found to be exchanged to.

Basic Receiving and Playing Operations

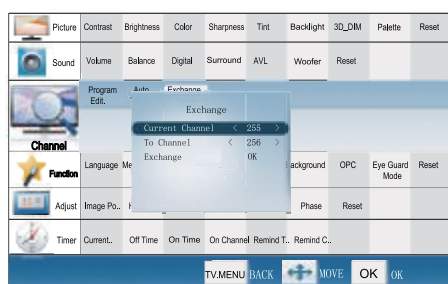

- After adjusting the current channel and the found to be exchanged to, press **▲/▼** to move the cursor to the Exchange option, and then press **OK** to start exchange and exchange the program on current channel to the channel you set for exchange.

- Press **◀/▶** to select the Picture Optimize option.
- Press **OK** to enter the submenu.
- Press **▲/▼** to select the DCCI/Color Management to be adjusted, and then press **◀/▶** to select ON or OFF.
- Press **▲/▼** to select the DNR to be adjusted, and then press **◀/▶** to select Low/Middle/High/ Off.

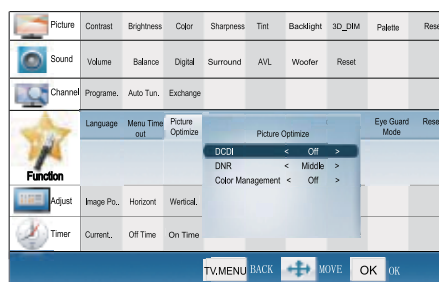

Function Menu

Function Menu Set

- Press **MENU** on the remote control unit or **MENU** on the TV's front panel to display the main menu, and then press **▲/▼** to select the Function menu.
- Press **◀/▶** to select the option to be adjusted, and then press **◀/▶** to adjust it.

Language

Two languages (i.e. Simplified Chinese and English) are available for your choice.

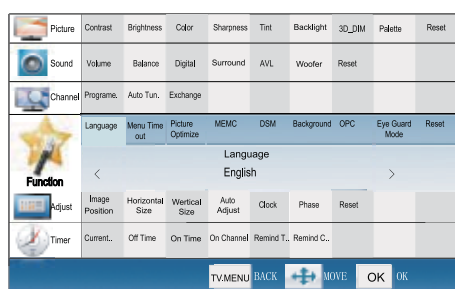

Menu Timeout

The option is for adjusting the menu display time. Press **◀/▶** to set the desired time (5-15s).

Picture Optimize

MEMC

Press **◀/▶** to set ON, Demo1, Demo2 or OFF, the moving picture will be better when MEMC is on function. (This function is only available for LE55A300/LB55R3)

DSM

Press **◀/▶** to select DEMO OFF, DEMO1, DEMO2, DEMO3.

Background

Press **◀/▶** to set ON or OFF, if you select ON, the TV screen will be blue if no signals are available.

OPC

- Press **▲/▼** to select the OPC, then press **OK** and **◀/▶** to select User/Dynamic/Daylight/Normal/Night.
- Press **▲/▼** to select the Adjust, then press **◀/▶** to set 0-10.
- Press **▲/▼** to select the Dynamic Contrast to be adjusted, and then press **◀/▶** to select ON or OFF.

Eye guard Mode

- Press **◀/▶** to select the Eye guard Mode option.
- Press **OK** to enter the submenu.
- Press **▲/▼** to select the Power E.G. Mode, then press **◀/▶** to select Standard/Eye Guard/Curtain.
- Press **▲/▼** to select the Change Ch.E.GI/Watching E.G./Watching E.G. Delay to be adjusted, and then press **◀/▶** to select ON or OFF.

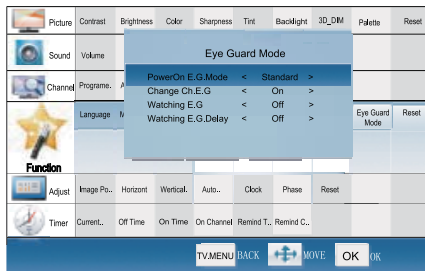

Reset

Press ◀ / ▶ to select **OK** or **Cancel** which with Do you want to reset option values.

Adjust Menu

The TV can be used as a display, and you may adjust relevant settings. Press **SOURCE** to switch the signal input to PC mode.

- 1 Press **MENU** to display the screen main menu, and then press ▲ / ▼ to select the Adjust menu as shown in the below figure.

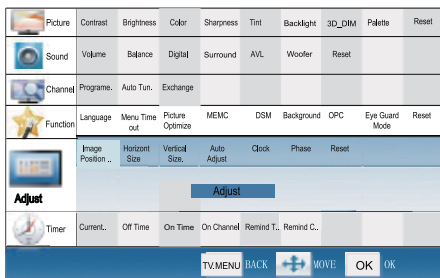

- 2 Press ◀ / ▶ to select the option to be adjusted.

- 3 Press ◀ / ▶ to adjust it.

Image Position

This is used to adjusting H-Position and V-Position.

H-Size

Horizontal size of picture can be adjusted in this item.

V-Size

Vertical size of picture can be adjusted in this item.

Auto Adjust

Vertical and Horizontal position of picture can be adjusted in this item.

Clock

This is used for adjusting the phase of pixel clock in PC mode.

Phase

This is used for adjusting H Position and V Position as well as relative parameters in PC modes.

Reset

Return to factory default settings.

Time Menu

- 1 Press **MENU** button and then use ▲ / ▼ button to select **Time** menu.

- 2 Press ◀ / ▶ to select the desired option, press **OK** to enter its submenu.

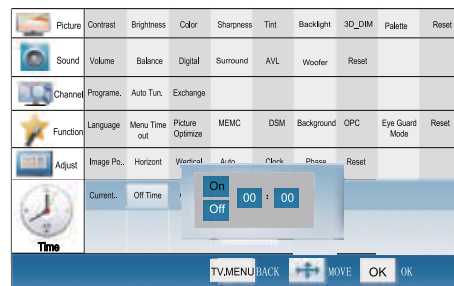

Current Time: The current time is calculated from the moment upon turning the TV on. At first, check whether the time indicated on the TV's clock is consistent with the standard time of your time zone; if not, adjust the clock as follows:

- Press **MENU** on the remote control unit or **MENU** on the TV's front panel to display the main menu, and then press ▲ / ▼ to select the Timer menu, afterwards press ◀ / ▶ to select the Current Time option, press **OK** to enter the submenu.
- Press ◀ / ▶ to set hour and minute.
- Press ▲ / ▼ to adjust the time.
- After finishing time setting, press **OK** or **MENU** to confirm.

Off Time/On Time: Set a time for the TV to turn off or on. This function allows the TV to automatically turn on or enter standby mode upon reaching the preset time.

- Press **OK** to enter the setting screen, and then press ▲ / ▼ to select ON or OFF, if you select ON, press ◀ / ▶ to set hour and minute. ON indicates

the On/Off Time function is enabled while OFF indicates the function is disabled.

- After finishing time setting, press **OK** or **MENU** to confirm.

Note

After setting the On/Off Time function, if the TV is AC off or forcible DC off, the function will be automatically cleared.

On channel: This function is used in combination with the On/Off Time function. When the TV turns on upon reaching the On time, it automatically enters the preset channel.

- Press **OK** first and then press ◀ / ▶ to set the On Channel or OFF.

Remind Time/Remind channel: The remind time and remind channel functions allow the TV to automatically enter the preset channel at preset time. If the TV is AC off or forcible DC off, the preset time will be cleared.

- Press **MENU** on the remote control unit or **MENU** on the TV's front panel to display the main menu, and then press ▲ / ▼ to select the Timer menu, afterwards press ◀ / ▶ to select the Remind Time option.
- Press **OK** to enter the setting screen, and then press ▲ / ▼ to select ON or OFF, if you select ON, press ◀ / ▶ to set hour and minute, and then press ▲ / ▼ to adjust time.
- After finishing time setting, press **OK** or **MENU** to confirm
- Press ◀ / ▶ to select the Remind Channel option, and press **OK** first and then press ◀ / ▶ to set the found.

Lock Setup

The television has the function of security default lock. Password needs to be entered when the program lock mode is to be set.

How to use the password function

Press **H. LOCK**, the TV screen will display Enter Password to prompt the user to enter password by pressing corresponding numerical keys; if the password is correct, the user enters the Lock Set menu; if incorrect, the user is required to enter a password again.

If there is no operation for a few seconds, the display will automatically disappear.

The Lock Set menu is as follows:

Lock Set		
Change Password		OK
Tuning Lock	< off >	
Preset Source	< off >	
Preset Prog	< off >	
Source Lock		OK
Child Lock	< off >	
Max Volume	< 100 >	
Power On Volume	< off >	
Unlock		OK

Change Password

After entering the Lock Set menu, press ▲ / ▼ to select the Change Password option, and then press **OK** to display the Change Password menu, afterwards enter a new 4-digit password by pressing numerical keys and repeat entering this password once again. If the user does not want to change the password in halfway, he may press **MENU** to exit from this menu.

Note

The initial password is 0000, and the password setting will not be changed after executing the Unlock option.

Tuning Lock

Press ▲ / ▼ to select the Tuning Lock option, and then press ◀ / ▶ to set ON or OFF. (If set ON, the Tuning Menu is not available in TV mode. To make any operation related to the Tuning Menu, it need to enter the Lock Set menu to set Tuning Lock OFF or execute the Unlock option.)

Preset Source Setting

Preset Source may be set as Off, TV, AV,Component, HDMI, PC and USB. When the Preset Source is set as TV, after entering the Preset Channel menu, press ◀ / ▶ to select the preset channel, and the channel will be forcibly switched to the preset one upon turning the TV on; when the Preset Source is set as other signal sources, the TV will be forcibly switched to the preset source upon turning on. For example, when the Preset Source is set as YP_bP_r/YC_bC_r, the TV will be switched to YP_bP_r/YC_bC_r upon turning on; when set as OFF, the preset function will be closed.

Preset Prog

Only when the Preset Source is set as TV can the Preset Channel option be available. Press ◀ / ▶ to select preset channels from 0-254.

□ Source Lock

This function is used to prohibit watching a program from various external inputs, e.g. AV and PC, etc. Press ▲ / ▼ to select a certain option, and then press **OK** to enter the submenu, press ◀ / ▶ to set an external input lock ON or OFF. If an external input lock is set ON, after entering this mode, the screen will display blue background with muting and a prompt Source Lock; during Source Lock prompt, Source Lock will remain if there is no other display on the screen. To watch a program from a locked external input, just enter Source Lock submenu to set corresponding status as OFF or execute the Unlock option in the Lock Set menu.

□ Child Lock Setting

Press ▲ / ▼ to select the Child Lock option, and then press ◀ / ▶ to set ON or OFF. If set ON, this control key will not respond, and the screen will display Child Lock when the key is pressed; if no other operation is made, the display will automatically disappear later. To resume Child Lock function, just enter the Lock Set menu to set Child Lock OFF or execute the Unlock option.

□ Max Volume Setting

Press ▲ / ▼ to select the Max Volume option, and then press ◀ / ▶ to freely adjust the max volume within the range of 0~100. After finishing the setting, the max volume in the Volume menu will not exceed the preset max volume; for example, if the preset max volume is 30, the volume in the Volume menu can not be increased any longer upon reaching 30; if the preset max volume is less than the value in the Volume menu, the latter will decrease along with the decrease of preset max volume.

□ Power on Volume

Press ▲ / ▼ to select the Power on Volume option, and then press ◀ / ▶ to freely adjust the volume within the range of 0~100.

□ Unlock Setting

Press ▲ / ▼ to select the Unlock option, and then press **OK** to clear all the lock settings, namely set all the lock setting options as OFF; the Preset Channel is set as OFF and max volume returns to 100 (except password).

Streaming Media Playing System

Note

- The diagrams in the following section are schematic and only for your reference. Please see the actual product if necessary.

1 Supported file formats:

- Picture: *. JPEG; PNG; BMP;
- Music: *. Mp3(8-320kbps); WMA(32-192kbps); AAC(16-576kbps)
- Movie:
 - MPEG4: *. avi files in accordance with Div*4. x/5. x Protocol;
 - MPEG2: some *. mpeg files;
 - MPEG1: *. dat and some *. mpeg files;
 - RealVideo
- Text: *. Txt.

Note

- Due to the particularity of file coding, some files may be unable to be read.

2 Supported equipment:

Support the equipment that supports Mass Storage Protocol and whose file system is FAT/NTFS/FAT16/FAT32, such as some USB disks, mobile hard disks, card readers, MP3 players and digital cameras. If USB equipment could not be identified due to unsupported file system, please format the equipment to the above-mentioned file system;

- 3** The external card reader supports most of the digital cards in the current market; the types of digital cards that can be read are relevant to the performance of selected card reader; you may attach standard mobile hard disks (working voltage 5.0V, working current not higher than 500mA); during media playing, do not pull out storage media, otherwise it may cause system halt, damage the files in storage media or damage USB equipment; sometimes, the TV may halt due to overhigh information error rate, in which case you should restart the system; there are a lot of nonstandard USB mobile equipment in the market, they may not be identified when connected to the streaming media playing system; the above phenomena may also occur on computers and are not the TV's fault.

- 4 To achieve smooth playing, ensure the following:
 - The file code rate should be lower than 300KB/S;
 - Due to the limitation of USB signal transmission distance, it is recommended not to use USB patch cord, in case of using the cord, make sure that its length is not over 1m;
 - Use high-speed USB equipment in conformity with USB2.0 Interface Standard; if USB equipment in conformity with USB1.1 Interface Standard is used, the playing may be unsmooth.
- 5 Although many movie files are with such postfixes as avi and mpeg, actually there are several formats in the files; however, the TV can only play some files in avi and mpeg formats. Some files with the postfix "dat" are not movie files, but data files commonly used in computers, and they can not be played as movies.

Start/Exit Streaming Media Playing System

- 1 Press **USB** on the remote control unit to select the streaming media function.
- 2 Insert USB equipment into corresponding USB interface 2s after starting the system.
- 3 After entering the system menu, press **◀/▶** on the remote control unit to select the required USB equipment, and then press **▲/▼** on the remote control unit to select the required file.
- 4 Press **OK** to enter the selected file.
- 5 To exit the streaming media playing system and watch a TV program, you must return to the streaming media main menu at first (to protect equipment), and then press **SOURCE** to select TV or directly press **USB** to return to the TV mode.

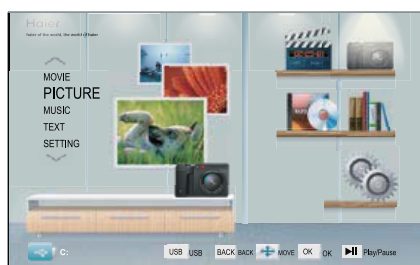

Operating Method of Streaming Media Menu

- 1 Press **▲/▼** to scroll through main menu or submenu and select your desired option.
- 2 Press **OK** to confirm your selection.
- 3 Press **REV/FWD** to achieve the FF (fast forward) and FB (fast back) of the movie or music being played.
- 4 Press **PLAY/PAUSE** to pause playing, and press it again or press **OK** to continue playing.
- 5 Press **ZOOM** to magnify pictures; in zoom mode, press **◀/▶** and **▲/▼** to move the picture.
- 6 Press **OK** to display and press **EXIT** to exit the screen display information while playing.
- 7 Press **BACK** to stop playing, or return to the previous menu, and press **BACK** repeatedly to return to the main menu.

Playing a Picture

- 1 After entering USB main interface, press **◀/▶** to select a harddisk partition, and then press **▲/▼** to select the Picture option.

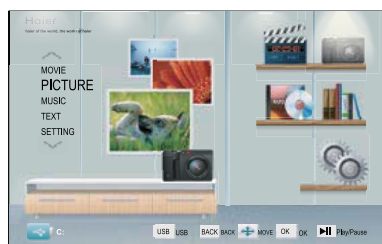

- 2 Press **OK** to confirm the selection and enter the picture playing interface.
- 3 Press **◀/▶** to change page, and press **◀/▶** to select the picture you want to play, and then press **OK** to enter the playing display interface.
 - Press **ZOOM** to magnify the picture, and then press **◀/▶/▲/▼** to move the picture.
 - Press **◀/▶** to select the last or next picture.
 - Press **▲/▼** to rotate the picture.



- 4 To exit playing, just press **BACK** repeatedly.

Playing a Movie

- 1 After entering USB main interface, press ◀/▶ to select a harddisk partition, and then press ▲/▼ to select the "Movie" option.



- 2 Press **OK** to confirm the selection and enter the movie playing interface.
- 3 Press ▲/▼ to change page, and press ◀/▶ to select the movie you want to play, and then press **OK** to enter the playing display interface.
- Press ◀/▶ to select the last or next movie.

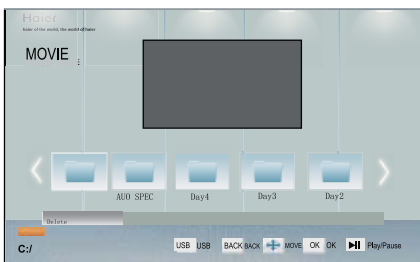

- 4 To exit playing, just press **BACK** repeatedly.

Note

- The menu display varies with the number and names of files in your equipment.

Playing Music

- 1 After entering USB main interface, press ◀/▶ to select a harddisk partition, and then press ▲/▼ to select the Music option.
- 2 Press **OK** to confirm the selection and enter the music playing interface.
- 3 Press ◀/▶ to change page, and press ▲/▼ to

select the music you want to play, and then press **OK** to play the music.

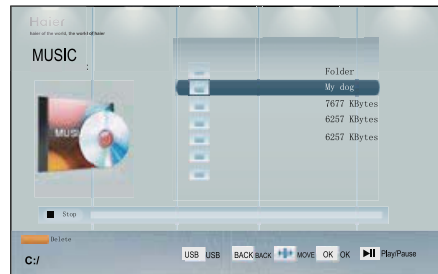

- 4 To exit music playing, just press **BACK** repeatedly.

Text

- 1 After entering USB main interface, press ◀/▶ to select a harddisk partition, and then press ▲/▼ to select the Text option.
- 2 Press **OK** to confirm the selection and enter the text playing interface.
- 3 Press ▲/▼/◀/▶ to select the text you want to read, and then press **OK** to play the text reading interface. Press ▲/▼ to change page, and press **BACK** to exit the reading interface.

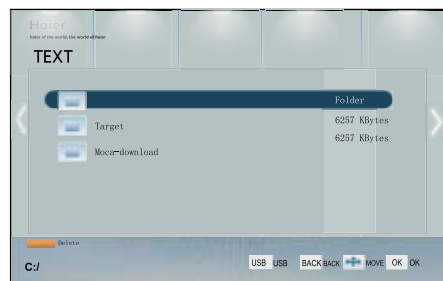

- 4 To exit the Text mode, just press **BACK** repeatedly.

Settings

- 1 After entering USB main interface, press ▲/▼ to select the Settings option.
- 2 Press **OK** to confirm the selection and enter the settings selection interface, and then press ▲/▼ to select the required options.

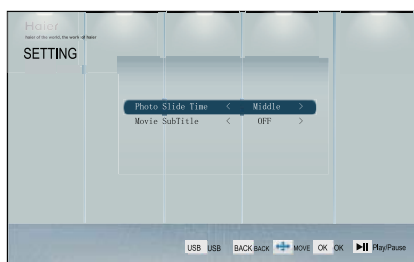

Photo Slide Time

Set the scan speed of pictures to be scanned in slide form.

There are three options (Middle/Slow/fast). Press ◀ / ▶ to select the desired option.

Movie Subtitle

Select "ON" or "OFF".

Maintenance

Maintenance

Early malfunctions can be prevented. Careful and regular cleaning can extend the amount of time you will have your new TV. Be sure to turn the power off and unplug the power cord before you begin any cleaning.

Cleaning the Screen

1 Here's a great way to keep the dust off your screen for a while. Wet a soft cloth in a mixture of lukewarm water and a little fabric softener or dish washing detergent. Wring the cloth until it's almost dry, and then use it to wipe the screen.

2 Make sure the excess water is off the screen, and then let it air-dry before you turn on your TV.

Cleaning the Cabinet

To remove dirt or dust, wipe the cabinet with a soft, dry, lint-free cloth. Please be sure not to use a wet cloth.

Extended Absence

If you expect to leave your TV dormant for a long time

(such as a vacation), it's a good idea to unplug the power cord to protect against possible damage from lightning or power surges.

Troubleshooting

For the sake of time and cost, it is strongly recommended that you checkout the problem by yourself according to the instructions listed hereunder before contacting the after-sales service for technical assistance.

Problem	Possible remedies
No picture, no sound	Turn on the power supply; Properly plug the TV set to the powersocket; Check to see if the power cable of other appliance is plugged in the TV set. Make sure that the power cable of the TV set is properly connected.
Problem	Possible remedies
Good picture, no sound	Depress the volume button; Check out the audio frequency input signals.
Failure of remote controller	Check to see if the remote controller display receiving window are blocked by other objects and if batteries are properly loaded.
No color, weak color or poor picture	Designate the item of color from the Picture menu and depress the volume button; Keep the display and VCR separate a reasonable space; Activate some functions to store picture brightness; Make sure that the display and signal source are available and turned on.
Excessive brightness or darkness	Adjust brightness or contrast.
Picture too big or small	Adjust the setup of sizes.
One speaker failure	Balance the sound in the menu.
Slight sound from display	It is a normal phenomenon.

Note

- Do not leave the television with static picture in an extended period as it may result in residual image on your television screen.

Note

- Production of the screen requires high and precision technologies. However, there might be some dark or bright (red, blue or green) spots, or some anomalistic stripes or spots. This is not defect. If the TV set is used in an area 2,400 meters above the sea level where the air pressure is below 750hpa, the picture on the screen maybe affected and a muffled sound might be produced. These phenomena might happen in the area 1,500 meters above the sea level. This is resulted from difference between air pressures inside and outside the display. This is not a defect covered by the limited warranty.

Specification

Basic specification and parameter

Power	~ 150-240V 50/60Hz
Color System	PAL, SECAM,NTSC
Stand-by Consumption	D/K, B/G, I, M
Video Input	USB,AV, Component, HDMI or PC,
Environmental condition	<p>Operating temperature range: +5°C - +35°C Operating humidity range: 20%-80% Storage Temperature: -15°C~+45°C Storage Humidity: 5%-90%, non-condensing</p> <p>If the storage temperature is lower than 0 °C, please first lays the machine aside after in the operating temperature environment carries on restores 2 hours, then electrifies the use again, protects your television not to receive the damage.</p>

Accessories

Owner's manual	x1
Remote Control	x1
Alkaline battery	x2
(This is only available for certain models, please refer to actual products.)	

Product main size (contain stand)

MODEL	Power Consumption	Net Size(LxWxH)	Net Weight
LE32A300	60W	788x210x559mm	8.7Kg
LE42A300	110W	1019x265x705mm	19.5Kg
LE55A300	160W	1315x280x689mm	28.5Kg
LB32R3A	100W	796x230x590mm	11.8Kg
LB42R3A	160W	1020x290x724mm	27.5Kg
LB46R3A	180W	1122x330x789mm	29.0Kg
LB55R3A	300W	1328x365x895mm	39.0Kg
LE32H300	60W	782x160x557mm	10.8Kg
LE42H300	110W	1019x265x705mm	19.5Kg
L32K3	100W	798x230x575mm	12.6Kg
L42K3	160W	1021x290x704mm	20.5Kg

Note

- Design and specifications are subject to change without notice. The dimension in this manual is a approximation.

Format

Recommendatory HDTV/SDTV(YPbPr/YCbCr) format

Sequence Number	Format	Refresh Frequency (Hz)
1	480i/480p	60
2	576i/576p	50
3	720p	50/60
4	1080i/1080p	50/60

Recommendation PC connection input format

Format

sequence number	Format	H-Frequency (KHz)	V-Frequency (Hz)
1	640*480@60Hz	31.5	60
2	800*600@60Hz	37.88	60
3	1024*768@60Hz (Recommendatory)	48.36	60

Recommendation DVI connection input format

Sequence Number	Resolution	Refresh Frequency (Hz)
1	640*480	60
2	800*600	60
3	1024*768	60

Recommendation HDMI connection input format

Sequence Number	Format	Refresh Frequency (Hz)
1	480i/480p	60
2	576i/576p	50
3	720p	50/60
4	1080i/1080p	50/60

