

# HITACHI

Color Plasma Display

Model Name

42PD8900TA

USER MANUAL

用戶手冊

用戶手冊

РУКОВОДСТВО ПОЛЬЗОВАТЕЛЯ



This is the image of the model 42PD8900TA.  
Desktop stand shown above is optional.



READ THE INSTRUCTIONS INSIDE CAREFULLY.  
KEEP THIS USER MANUAL FOR FUTURE REFERENCE  
For future reference, record the serial number of your monitor.  
SERIAL NO. \_\_\_\_\_

This serial number is located on the rear of the monitor.

# USER MANUAL

Thank you for purchasing the HITACHI Plasma Display.  
Please read this user manual carefully before operating  
this product.

To ensure proper operation, please read and follow ALL  
the instructions, especially the "IMPORTANT SAFETY  
INSTRUCTIONS" and "SAFETY PRECAUTIONS".  
Please keep this user manual for future reference.

## CONTENTS

<b>IMPORTANT SAFETY INSTRUCTIONS</b> .....	<b>1</b>	<b>MENU OPERATION</b> .....	<b>21</b>
<b>INTRODUCTION</b> .....	<b>2</b>	How to use the On-Screen Display (OSD) system.....	21
About This Manual .....	2	Language Menu .....	21
Trademark Credits.....	2	Setup Menu (TV mode).....	22
About Software.....	2	Setup Menu (AV mode).....	24
<b>SAFETY PRECAUTIONS</b> .....	<b>3</b>	Setup Menu (RGB mode).....	25
About the Symbols .....	3	Function Menu.....	27
Cleaning and Maintenance.....	6	Picture Menu (TV/AV mode).....	29
<b>ABOUT PLASMA DISPLAY</b> .....	<b>7</b>	Picture Menu (RGB mode).....	32
Image Retention of Plasma Display .....	7	Audio Menu .....	34
Common phenomena of Plasma Display Panel .....	7	Timer Menu .....	35
<b>FEATURES</b> .....	<b>8</b>	<b>FUNCTION</b> .....	<b>36</b>
<b>SUPPLIED ACCESSORIES</b> .....	<b>8</b>	Power Swivel.....	36
<b>OPTION</b> .....	<b>8</b>	About Teletext.....	37
<b>COMPONENT NAMES</b> .....	<b>9</b>	Size Switching.....	38
Main Unit .....	9	Multi Picture Mode.....	40
Remote Control .....	10	Picture Freezing .....	44
<b>PREPARATION</b> .....	<b>11</b>	Photo Input Function .....	45
Remote Control Batteries Installation .....	11	Audio Switching.....	51
Caution When Moving the Main Unit.....	11	Power Save Mode .....	52
Safety Precaution on Main Unit Installation.....	12	DVD Player / STB Selection.....	53
Anti-Tumble Measures .....	12	<b>TROUBLESHOOTING</b> .....	<b>54</b>
<b>CONNECTION</b> .....	<b>13</b>	When Following Messages Appear on the Screen.....	54
Terminal Positions .....	13	Symptom and Check List .....	54
Connecting Procedure.....	13	<b>PRODUCT SPECIFICATIONS</b> .....	<b>57</b>
<b>BASIC OPERATION</b> .....	<b>18</b>	Signal Input .....	58
Power On/Off.....	18	Recommended Signal List .....	59
First Time Setup .....	19		
Volume UP/DOWN .....	19		
Mute .....	19		
Input Switching to TV/AV1~5, HDMI, and RGB .....	20		
Input Signal Screen Display .....	20		

## IMPORTANT SAFETY INSTRUCTIONS

- Read this instruction thoroughly.
- Retain this instruction for future reference.
- Heed all warnings and cautions to prevent possible danger.
- Follow all instructions. Improper handling could cause personal injury and/or serious damage to the unit that may shorten its service time.
- Do not block any ventilation openings.
- Install the product in accordance with the manufacture's instructions.
- Before calling for the technical support or service technician, read "TROUBLESHOOTING" (54 ~ 56) to determine the symptoms when problems occur during installation or operation of the product.
- If serious problems happen (such as smoke or an abnormal odor from the unit), turn off the Main Power, unplug the Power Cord, and then, contact your local dealer immediately.

## INTRODUCTION

Thank you for purchasing the HITACHI Plasma Display. We hope that you will enjoy the great performance with this product.

This Plasma monitor has been designed to meet the International standards. However, it could cause personal injuries and property damage if improperly handled. In order to prevent potential danger and obtain maximum benefit from your set, please observe the following instructions when installing, operating, and cleaning the product. Keep this manual for future reference, and record the serial number of your set in the space provided on the front cover page of this manual.

ENGLISH

## About This Manual

- The information in this manual is subject to change without notice.
- This manual has been created with extra care. In case that you have any comments or questions regarding this manual, please contact your local dealer or our Customer Service Center.
- Before operating this set, please fully understand the prerequisite such as specifications or constraints of the hardware and software. We are not responsible and have no liability for any loss, damage or injury as a result of misuse.
- Reproduction, copying, use, modification, and/or transmission in whole or in part of this manual are prohibited without any prior written permission.
- All other products and company names used in this manual are trademarks or registered trademarks of their respective owners.

## Trademark Credits

- VGA and XGA are trademarks of International Business Machines Corporation.
- APPLE and Macintosh are registered trademarks of Apple Computer Inc.
- VESA is a registered trademark of the Video Electronics Standard Association.
- Licensed by BBE Sound, Inc. under USP5510752 and 5736897.  
BBE and BBE symbol are registered trademarks of BBE Sound, Inc.  
Manufactured under license from BBE Sound, Inc.
- WOW, SRS and (●) symbol are trademarks of SRS Labs, Inc.  
WOW technology is incorporated under license from SRS Labs, Inc.
- SD Logo is a trademark.
- HDMI, the HDMI logo and High-Definition Multimedia Interface are trademarks or registered trademarks of HDMI Licensing LLC.

Even if no special notation has been made of company or product trademarks, these trademarks have been fully respected.

## About Software



You may not alter, decompile, disassemble, decrypt, or otherwise reverse-engineer the Software installed in this product, which are prohibited by law.



# SAFETY PRECAUTIONS





For your safety, please read the following precautions carefully before using this product. Improper use would cause serious personal injuries and/or damage to your property or this product.

## About the Symbols

The following are the symbols used in this manual and affixed on the unit itself. Please fully understand the meanings of the symbols before reading the instructions in this section.

 <b>WARNING</b>	Never ignore the instruction. There are risks of serious injuries or possible death to the user.
 <b>CAUTION</b>	Do not ignore the instruction. There are possibilities of personal injuries and/or property damage.

Other Symbols	
	The triangle with illustration is intended to alert the users that there are possibilities of fire, burst, or high temperature if the product is handled improperly. Each illustration within the triangle specifies the contents in detail. (The figure on the left is an example.)
	The circle with diagonal line and illustration is intended to prohibit the users from doing the indicated actions when handle the product. Each illustration within this symbol specifies the contents in detail. (The figure on the left is an example.)
	The blacked out circle with illustration is intended to constrain the users to follow the indicated actions when handle the product. Each illustration within this symbol specifies the contents in detail. (The figure on the left is an example.)

 <b>WARNING</b>	
<b>There is a risk of fire, electric shock, or serious injury.</b>	
<p>■ <b>Unplug the power cord immediately when serious problems happen.</b></p> <p>Serious problems such as</p> <ul style="list-style-type: none"> <li>• Smoke, abnormal odor or sound comes out from the product.</li> <li>• No picture, no sound or distorted picture on the display.</li> <li>• Foreign objects (such as water, metals etc) get inside the unit.</li> </ul> <p>Do not continue using the product under these abnormal conditions. Turn off the Main Power, unplug the Power Cord, and contact your dealer immediately.</p> <p><b>For your safety, never try to repair the product by yourself.</b></p>	 Disconnect the plug from the power outlet.
<p>■ <b>Do not insert liquids or any foreign objects (such as metals or flammable items) inside the unit.</b></p> <ul style="list-style-type: none"> <li>• In case it happens, turn off the main power, unplug the Power Cord, and contact your dealer immediately.</li> <li>• Use special caution when younger children are around the unit.</li> </ul>	
<p>■ <b>Do not remove cover, or modify the product.</b></p> <ul style="list-style-type: none"> <li>• High-voltage components are installed inside of the unit. Removing covers can expose you to high voltage, electrical shock, and other dangerous conditions.</li> <li>• Contact your local dealer to perform servicing such as inspection, adjustment, or repair work.</li> </ul>	  Do not disassemble

## SAFETY PRECAUTIONS (continued)

ENGLISH

### WARNING

**There is a risk of fire, electric shock, or serious injury.**

■ **Install the unit at a proper area where it does not expose anyone to any danger.**

- If you hit against the edge of the unit, you may be injured.



■ **Do not place any objects on top of the unit.**

Objects such as

- Liquid containers (vase, fish tank, flowerpot, cosmetics or liquid medicine).
- If water or any liquid spill onto the unit, it may cause short-circuit and result in fire or electrical shock.
- In case that it happens, turn off the Main Power, unplug the Power Cord, and contact your dealer immediately.
- Do not place anything heavy on top of the unit.
- Do not climb on or hang from the unit.
- Do not let your pets get on top of the unit



■ **Do not expose this unit to rain or moisture.**

- Never use this unit in the bathroom or shower room.
- Beware when you use this product outside, especially in rainy, or snowy weather, and at the beach or waterfront.
- When the product gets wet, it could cause fire or electrical shock.



■ **Unplug this unit during lightning storm.**

- To reduce the risk of electrical shock, do not touch the product when starts lightning.



Disconnect the plug from the power outlet.

■ **Do not do anything that may damage the Power Cord.**

- Do not damage, modify, twist, forcibly bend, heat, or pull excessively the Power Cord.
- Do not place heavy objects (including the unit itself) on top of the Power Cord.
- If the Power Cord is damaged, contact your dealer for repairs or exchange.



■ **Use only with designated power supply voltage.**

- To prevent the risk of fire and electrical shock, operate this product only with the power supply voltage indicated on the unit.



■ **Beware not to drop or have any impact on the unit.**

- Take extra care while moving the unit.
- The plasma display panel is made of glass. In case that it breaks, you may be injured by the broken pieces.
- In case that you drop the unit or the cabinet is damaged, turn off the Main Power, unplug the Power Cord and contact your local dealer immediately.
- Continuing use of the product with above conditions may cause fire or electrical shock.



■ **Clean dust or metals on or around the blade of the power plug regularly.**

- Continuing use of the product with above condition may cause fire or electrical shock.
- Always unplug the Power Cord first, and clean the blade with dry cloth.

















■ **Do not place the unit on an unstable surface.**

Unstable places such as

- Sloped place or shaky rack, table, stand or trolley.
- If the unit falls down, it could cause personal injury.



## SAFETY PRECAUTIONS (continued)

 <b>CAUTION</b>	
<p>■ <b>Do not place the unit at the dusty place.</b> It could cause malfunction.</p>	
<p>■ <b>Do not cover or block any ventilation holes on the product.</b> The monitor would overheat, and it could cause fire or damage the product which may shorten its service life.</p> <ul style="list-style-type: none"> <li>• Install the product in accordance with the instructions in this manual.</li> <li>• Do not place the unit with ventilation side down.</li> <li>• Do not install the unit on the carpet or bedclothes.</li> <li>• Do not cover the unit with table cloth etc.</li> </ul>	
<p>■ <b>Be sure to ground the earth cable correctly.</b></p> <ul style="list-style-type: none"> <li>• Especially when you use Power Cord adapter, be sure to connect the earth cable to the ground terminal. Incorrect connection would cause fire or electrical shock.</li> <li>• For your safety, always make sure to unplug the Power Cord before connect or disconnect the earth cable .</li> </ul>	 Supply connect the ground wire.
<p>■ <b>Follow the Anti-tumble measures in this manual.</b></p> <ul style="list-style-type: none"> <li>• If the unit tumble down, there is a risk of personal injury and possible death. Also, it would damage the product seriously.</li> </ul>	
<p>■ <b>Do not install this product near the medical devices.</b></p> <ul style="list-style-type: none"> <li>• To prevent malfunction of the medical devices, do not use this product and the medical devices in the same room.</li> </ul>	
<p>■ <b>Do not place the CRT-based television near the speakers of the Plasma Display.</b></p> <ul style="list-style-type: none"> <li>• It could cause the partial discoloration or blurring of the image on the CRT-based television. Please install it away from the speakers of the unit.</li> </ul>	
<p>■ <b>Disconnect all of the external connection cables and detach the anti-tumble measures before moving the unit.</b></p> <ul style="list-style-type: none"> <li>• It may cause fire, electrical shock, or personal injuries.</li> </ul>	
<p>■ <b>Connect the power plug securely.</b></p> <ul style="list-style-type: none"> <li>• Improper connection will cause overheat and may result in fire.</li> <li>• Do not touch the blade of the plug while connecting it to the wall socket. It could cause electrical shock.</li> <li>• If the plug is not fitted for the wall socket, contact your dealer for replacement.</li> </ul>	 
<p>■ <b>Do not handle the Power Cord with wet hands.</b></p> <ul style="list-style-type: none"> <li>• It could result in electrical shock.</li> </ul>	
<p>■ <b>Do not pull the cord when you unplug the Power Cord.</b></p> <ul style="list-style-type: none"> <li>• It may damage the cord and could result in fire or electrical shock.</li> <li>• Hold the plug when disconnecting it.</li> </ul>	
<p>■ <b>Unplug the Power Cord when unused the product for long periods of time.</b></p>	
<p>■ <b>Handle the batteries properly.</b></p> <ul style="list-style-type: none"> <li>• Improper or incorrect use of the batteries may cause corrosion or battery leakage, which could cause fire, personal injury or taint damage to the property.</li> <li>• Use only the types of the batteries which are indicated in this manual.</li> <li>• Do not install new batteries with used ones.</li> <li>• Install the batteries correctly by following the polarity (+ and -) indications on the battery compartment.</li> <li>• Do not dispose the used batteries as domestic waste. Dispose them in accordance with the local regulations.</li> </ul>	

## SAFETY PRECAUTIONS (continued)

### PRECAUTIONS

ENGLISH

#### ■ Do not install the unit in high temperature.

It could damage the cabinet or parts of the product.

- Do not install near any heat sources such as radiator, heat registers, stoves, or other apparatus that produce heat.
- Keep the unit out of direct sunlight. It could increase the temperature of the unit and cause malfunction.



#### ■ Viewing Advice

- The lighting of the environment in which the product is used should be appropriate. Too bright / dark environment is not good for your eyes.
- Take time to relax your eyes occasionally.
- When you use this product, keep away from the unit 3~7 times of the vertical length of the panel. This is the best viewing distance in order to protect your eyes against eyestrain.
- Adjust the volume in appropriate level, especially during the night.

#### ■ When transporting this product:

- When the product needs to be transported due to moving or repair, use the carton box and buffer material comes with this product.
- Do not keep this product lying sideways during transportation. It could damage the panel glass or degrade the phosphors of the panel.



#### ■ Keep away from the unit when you use radio.

This unit is designed to meet the international EMI standards due to prevent the interference against the radio. However, the unit may generate noise in the radio.

- If the noise is in the radio, please try the following actions.
  - Adjust the direction of the radio antenna in order not to receive the interference radio wave from the unit.
  - Keep the radio away from the unit.
  - Use coaxial cable for the antenna.



#### ■ About the infrared communication devices:

- The infrared communication devices such as cordless microphone or cordless headphone may not be available around the unit. It is because of the communication failure. Please note that this is not malfunction.

#### ■ When you dispose this product at the end of its life, follow the regulations at your residential area.

- For more information, contact the local authority or the dealer where you purchased the product.

## Cleaning and Maintenance

Please make sure to unplug the power cord before cleaning the unit.

#### ■ How to clean the plasma screen panel of the unit.

- The panel surface is specially-coated to reduce the reflection and cut infrared radiation; thus, wipe the panel with a lint-free and dry cloth in order to prevent damage to the coating.
- Do not use a chemical cloth or cleaner. Depending on the ingredients, it may cause discoloration and damage on the coating.
- Do not wipe with a hard cloth or rub hard. It may hurt the coating.
- In case of the greasy dirt such as fingerprint, wipe with a lint-free cloth moistened by a diluted neutral detergent solution, and then wipe with a soft and dry cloth.
- Do not use a spray cleaner. It could remove the coating or cause malfunction by entering inside of the unit.

#### ■ How to clean the cabinet of the unit.

- The following may cause crack, deformation, and paint peeling.
  - Do not wipe the cabinet with benzene, thinner, and other chemical products.
  - Do not spray volatile solutions such as insecticide over the cabinet.
  - Do not leave the cabinet in prolonged contact with plastic or rubber materials.
- Do not use a chemical cloth, cleaner or wax. Depending on the ingredients, it may cause crack and deformation.
- Use a lint-free cloth to clean the cabinet and control panel of the unit. In case of the heavy dirt, wipe with a soft cloth moistened by a diluted neutral detergent solution, and then wipe with a soft and dry cloth.
- Never use the following detergents. It could cause crack, discoloration, and scratch.
  - Acid/alkaline detergent, alcoholic detergent, abrasive cleaner, powder soap, OA cleaner, car wax, glass cleaner, etc.



## ABOUT PLASMA DISPLAY

### Image Retention of Plasma Display

The plasma display has one of characteristics that results in panel image retention depending on how the plasma display is used. The following are the common cases and effective usages regarding the image retention.

#### Characteristics of Image Retention

- The phenomenon of image retention is caused by partially degrading the phosphor due to the partial display of character and figure.
  - For example, when the character image as shown in Fig. A is displayed continuously for a long period of time, only the phosphors (Red/Green/Blue) displaying the characters is degraded. Consequently, in case of displaying all white image on the entire screen as shown in Fig. a, the marks remaining by the characters will give color differences; therefore, note that it is not burnt remains of the phosphor.
- The degree of image retention is proportional to the Brightness and Display Time for the characters and/or figures.
  - The brighter the characters and figure, the more phosphor is degraded. As shown in Fig. B, in case of displaying images that have different brightness each for a long time, Fig. b shows that the brighter image tends to obtain more remains.

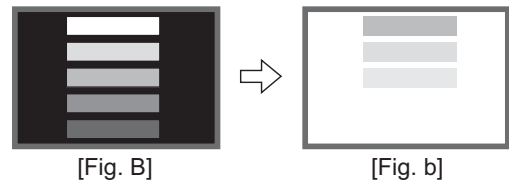
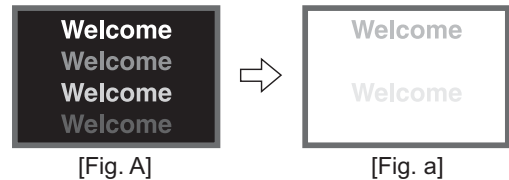

\* The illustrations are images to explain the image retention. The actual manners on the image retention vary depending on such conditions as operation time and brightness.

#### Method to Reduce Image Retention

- Use “Screen Wipe” or “Luminance Manager” function on the display, which are available from Function Menu. (Refer to [27](#)~[28](#).)  
After displaying certain images such as still image for a long time, “Screen Wipe” can be used to reduce the image retention by displaying a completely white screen for about 1~2 hours. In addition, “Luminance Manager” function works in case of displaying such images on the four corners as TV station logos and clock display.
- Use in combination with moving images.  
Since the entire screen has relatively even degradation of the phosphor in moving images, it can avoid the partial image retention. We recommend to use together with such moving images as DVD.
  - Please be careful that leaving the images in 2-picture mode for a long period of time can cause the image retention.
  - Some television broadcasts contain images of which cut the left/right or top/bottom, and which broadcast station or clock is displayed for a long time at the same position. Please be aware that it may cause the image retention.
  - Image retention can be reduced by “Eco Mode” in Function menu. [27](#)

### Common phenomena of Plasma Display Panel

The following are the common phenomena when operating Plasma Display Panel due to its structural reason. Please note that they are not malfunctions.

#### • Residual image

When a still image or menu is displayed on the screen for a short time (about a minute) and then switches to another image, it may leave an “after-image” on the screen.  
The residual image will disappear on its own.

#### • Surface on Panel

The plasma panel displays images by generating discharges internally. This could raise the temperature of the display surface. In addition, do not impact strongly on the surface of panel because plasma panel is fine-processing glass even though the panel strengthens by the front filter made of tempered glass.

#### • Defective Spots on Panel

The plasma display panel is manufactured with high-precision technology. However, there might be some spots that are not emitted, brighter than the others, or in different colors, etc.

## FEATURES

Enjoy not only beautiful and high quality pictures on the display, but also various kinds of useful and convenient functions in your daily life!

- Large-screen and high-definition plasma display.
- Enjoy high resolution display with 1024 (H) x 1080 (V) pixels.
- Improved Digital signal processor.
- High quality sound with deeper, richer and dynamic bass tones.
- Accept more digital input devices with 2 HDMI terminals.
- Great diversity of connecting terminals to cover wide range of audio-visual equipments.
- Enjoy the image from PC with large, high-definition Plasma screen.
- New Photo Input function with selectable Background Music.
- SD Card Slot installed.
- Easy-to-use On-Screen Display system operating with Remote control.
- Low power consumption with Power Saving feature.
- Motorized Power Swivel feature. (Desktop stand is optional.)

## SUPPLIED ACCESSORIES

Check the supplied accessories before installation.  
In case of missing or damaged, please contact the dealer immediately.

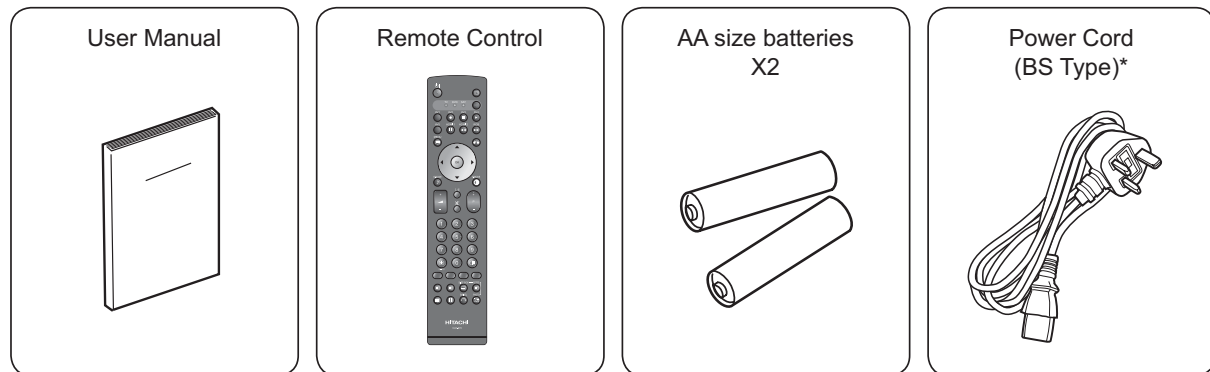

\*The type of power plug provided may be different from this drawing for some countries.

## OPTION

Ask your local dealer for further details.

Desktop Stand : SD8G4237

# COMPONENT NAMES

## Main Unit

### Front Panel

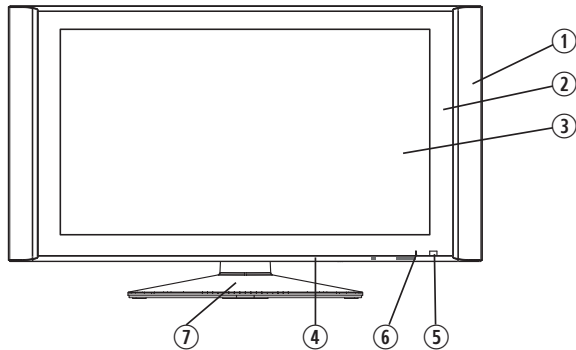

- ① Speaker
- ② Cabinet
- ③ Panel
- ④ Main Power Switch (on the bottom surface)
- ⑤ Remote Control Receiver
- ⑥ Indicating Lamp
- ⑦ Desktop Stand (option)

### Rear Panel

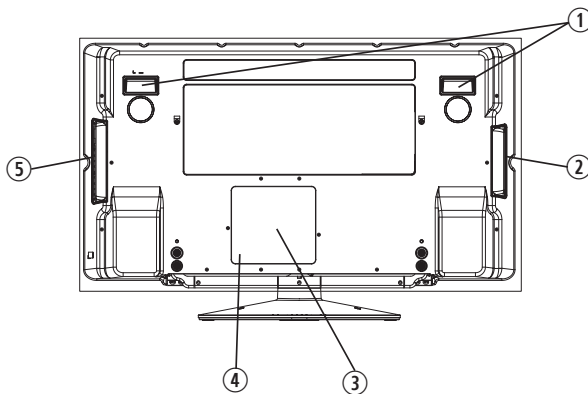

- ① Handgrips
- ② Side Input
- ③ Terminal Board (External Device Connection)
- ④ Power Cord Socket
- ⑤ Control Panel (see below for details)

Please refer to **13**~**17** for the detailed information for the connections.

### Control Panel (including Card Slot)

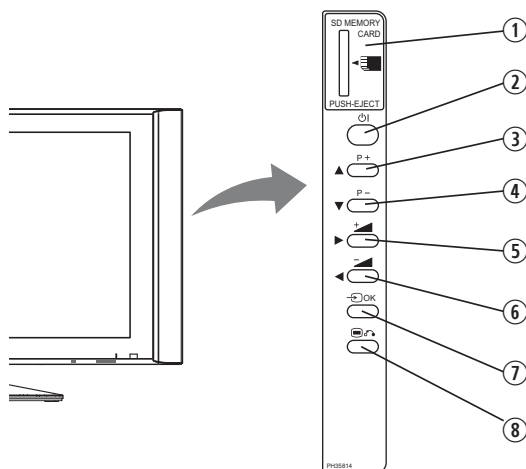

- ① SD Memory Card Slot
- ② Sub Power button
- ③ Channel UP/▲ button
- ④ Channel DOWN/▼ button
- ⑤ Volume UP +▲/▶ button
- ⑥ Volume DOWN -▲/◀ button
- ⑦ Input Select /OK button
- ⑧ Menu / Return button

## COMPONENT NAMES (Continued)

### Remote Control

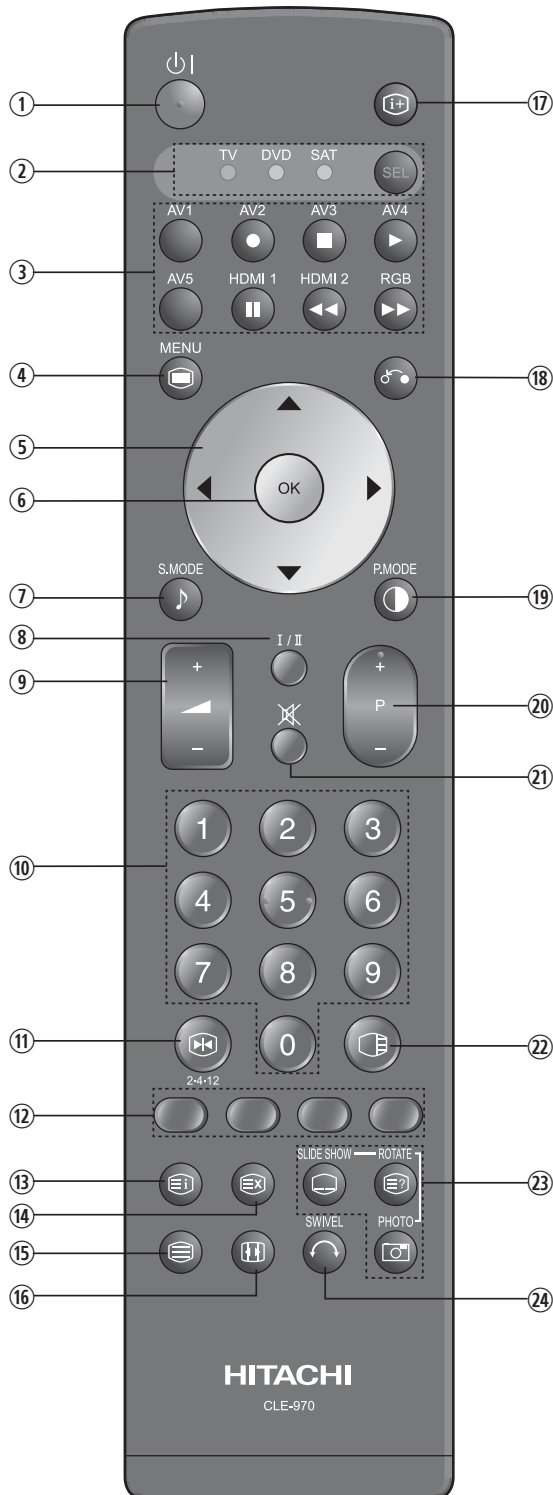

- ① **Sub Power**
- ② **Function Select (TV/DVD/SAT)**  
Press this button to select function mode indicating LED lamp.  
Normally, select "TV".
- ③ **Input Select/DVD Control/Photo Input Control**  
Press this button to change input mode.  
In addition, you can use these buttons while operating the selected brand of DVD player or Photo Input function.
- ④ **Menu**
- ⑤ **Cursor**
- ⑥ **OK**
- ⑦ **Sound Mode**  
Sound mode can be changed each time pressed in the following sequence. Movie→Music→Speech→Favorite
- ⑧ **CHI/II**  
This is exclusively for TV audio A2/NICAM mode.
- ⑨ **Volume Up/Down**
- ⑩ **Program Select**  
Press these buttons to select a TV program directly.
- ⑪ **Freeze/Multi Mode [Hold]**  
Press this button to change the picture to freeze mode. Press it again to return to normal picture. In addition, during multi-picture mode, each time press this button, the picture is changed to 2, 4, and 12 multi mode.
- ⑫ **[Color (Red, Green, Yellow, Blue)]**
- ⑬ **[Index]**
- ⑭ **Time [Cancel]**  
Pressing this button can indicate the time by On-Screen display when receiving a TV program on the screen.
- ⑮ **TV/Text [TV↔Text]**  
This switches between the TV mode and the Teletext mode.
- ⑯ **Zoom [Text↔TV+Text]**  
Press this button to change picture size.
- ⑰ **Recall**  
Pressing this button shows the input signal status.
- ⑱ **Return**  
You can use this to return to the previous menu.
- ⑲ **Picture Mode**  
Picture mode can be changed each time pressed in the following sequence. Dynamic→Natural→Cinema
- ⑳ **Channel Up/Down**
- ㉑ **Mute**
- ㉒ **Multi Picture**  
Press this button to change the picture to multi-picture mode. Press it again to return to normal picture.
- ㉓ **Photo Input (Photo/Rotate/Slide Show)**  
These buttons are to display and control the pictures from digital still camera or USB card reader.
- ㉔ **Swivel (with optional Desktop Stand)**  
This function is to rotate TV. Select the degree of rotation with cursor key.

**NOTE**

Some buttons are only for Teletext mode, and other buttons have different functions in Teletext mode from the use of TV mode. Those buttons are indicated by [ ]. Refer to "About Teletext" on [37](#).

## PREPARATION

### Remote Control Batteries Installation

This remote control operates on 2 “AA” batteries.

#### 1. Open the battery compartment cover

- Slide open the battery compartment cover on the backside of the remote control in the direction of an arrow.

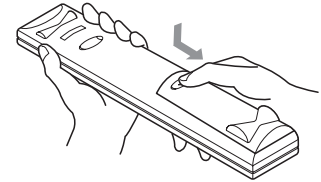

#### 2. Install the batteries

- Install 2 “AA” batteries (included) making sure the polarities match the indication inside the compartment.

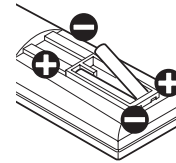

#### 3. Close the battery compartment cover.

- To close the battery compartment cover, slide the cover in the direction of an arrow till it clicks shut.

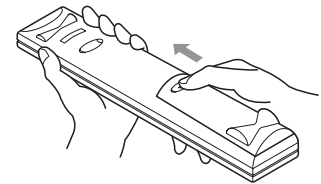

### CAUTION

**It could cause corrosion or battery leakage and may result in physical injury and/or property damage including fire.**

- Never mix used and new batteries in the device.
- Replace all the batteries in a device at the same time.
- Remove the batteries if the remote control is not going to be used for an extended period of time.

**To avoid possible failure, read the following instructions and handle the remote control properly.**

- Do not drop or have an impact on the remote control.
- Do not spill water or any liquid on the remote control.
- Do not place the remote control on the wet object.
- Do not place the remote control under the direct sunlight or near sources of excessive heat.

### Caution When Moving the Main Unit

As this product is heavy, whenever it is moved, two people are required to transport it safely.

Whenever the unit is moved, it should be lifted forwards using the two handgrips at the back, and the unit should then be held at the base on both sides for stability.

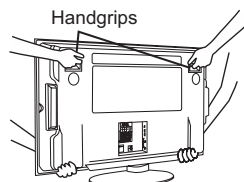

## PREPARATION (continued)

### Safety Precaution on Main Unit Installation

#### Read SAFETY PRECAUTIONS ( 3 to 6 ) carefully besides this page.

\*When installing the unit, use the optional Desktop Stand (SD8G4237). Please refer to the user manual of the stand. The Desktop Stand (Option) has been used for the illustration in this manual.

When installing the main unit, be sure to use the specified mount units in order to obtain maximum performance and maintain the safety.  
We assume no responsibility or liability for personal injuries or property damages caused by use of other mount units or improper installation.

As for the installation instruction, please read each user manual of the mount units: for Desktop Setup, Wall Mounting, and Ceiling Mounting.

In case of using Wall or Ceiling Mounting unit, by contacting your local dealer, ask the specified installation specialist to set up. Never attempt to install it by yourself. It could cause injuries or damages.

Please leave the adequate space around this unit in order to avoid increasing the internal temperature and keep safety while using swivel function.

Make sure not to block any ventilation holes.

Do not install the unit in the small space such as inside the rack, closet or the box.

Leave more than 10cm of clearance from each side of monitor and 30cm from the top of unit to wall.

Without Swivel function: Leave at least 10cm of clearance behind rear unit.

With Swivel function: Leave at least 31cm of clearance to obtain the maximum performance of Swivel Function. Refer to 36 for Swivel Function.

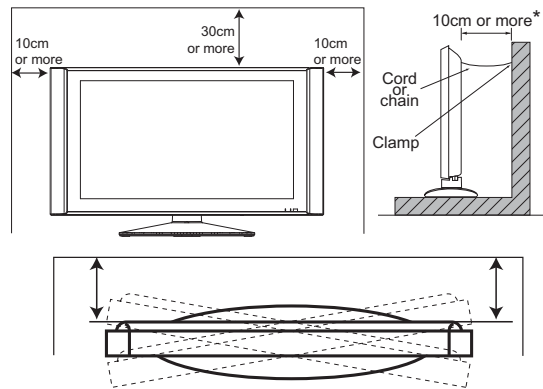

### Anti-Tumble Measures

Install in a stable place and implement safety measure against overturning.

#### Securing on desktop

Use two wood screws to secure the set firmly in position by fastening them to the screw holes at the rear of the stand as shown in the diagram. The wood screws are supplied with the optional stand.

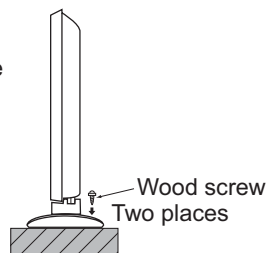

#### Securing to a wall or pillar

Using a commercially available cord, chain, and clamp, secure the set to a wall or pillar.

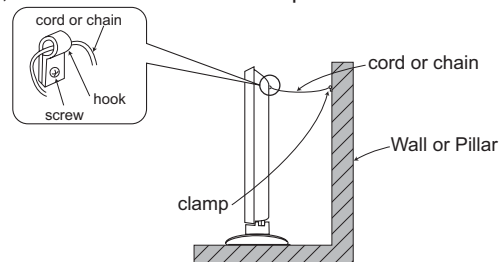

#### Securing to ceiling

Using a commercially available cord, chain, and clamp, secure the set to a ceiling.

#### NOTE

- For more information regarding the mounting of the unit, please contact your dealer.
- Loosen a cord or chain enough while operating power swivel to avoid physical injury.
- Please install the unit at a proper area where it does not expose anyone to the danger of hitting themselves (for example their hands, head or face, etc) against the edge of the unit and cause personal injury.

# CONNECTION

## Terminal Positions

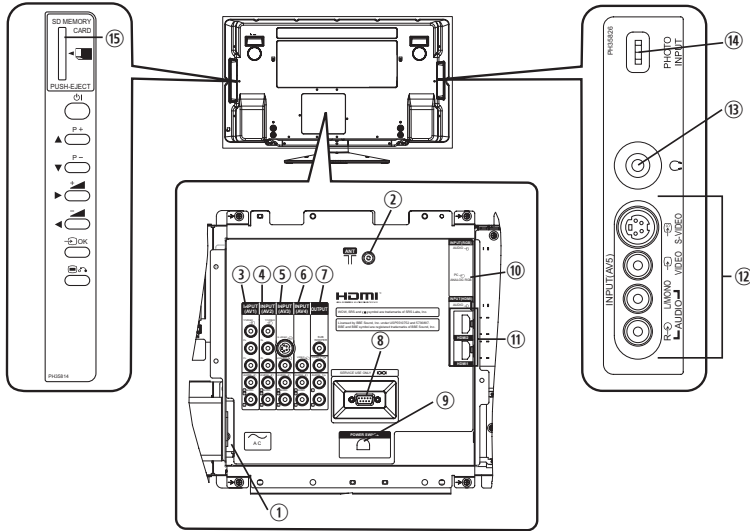

### Rear

- ① Power Cord Socket
- ② Aerial Socket
- ③ AV1
- ④ AV2
- ⑤ AV3
- ⑥ AV4
- ⑦ Monitor Out and Sub Woofer
- ⑧ Service use only
- ⑨ Power Swivel Terminal (see 36)
- ⑩ PC Connection terminals (D-sub 15 pin and mini stereo for Audio)
- ⑪ HDMI1, 2 and mini stereo for Audio

### Side

- ⑫ AV5
- ⑬ Headphone input
- ⑭ Photo Input terminal
- ⑮ SD Memory Card slot

## Connecting Procedure

This unit is ready for various kinds of connections. Make a connection in the following steps. Be sure to turn off the Main Power first when connecting external equipments.

1. Connect Power Cord to the rear panel.
2. Connect Aerial Lead.
3. Connect your external equipments to the unit if any.
4. Connect the Power Plug to the Wall Socket.

### 1. Connecting Power Cord to the Rear Panel

Connect Power Cord to the monitor.

\*Make sure not to connect the Power Plug to the Wall Socket until all connections are completed.

### 2. Connecting Aerial Lead.

There are two ways to connect Aerial Lead.

- ① **When you do not have any other external equipment:**  
Connect the Aerial Lead directly into the Socket at rear panel.
- ② **When you have one or more external devices to connect:**
  1. Use RF cable to connect between each equipment and Antenna.
  2. Connect the Aerial Lead to an equipment 'In' Socket marked
  3. Connect the RF cable from the equipment 'Out' to the other equipment 'In.'
  4. Then, connect from the equipment 'Out' to "ANT" on the plasma screen Socket on marked

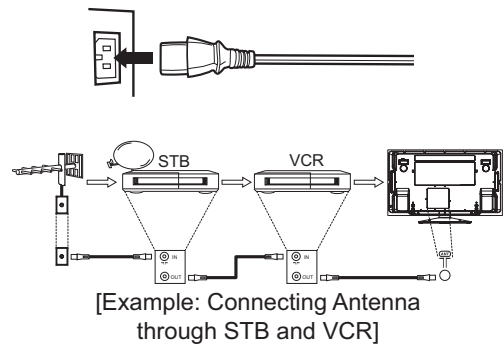

### Precautions when connecting the aerial

- Please use a coaxial cable which is free from interference to connect the aerial. Avoid using a parallel flat feeder wire as interference may occur, causing reception to be unstable and stripe noise to appear on the screen.
- Avoid using indoor aerial as this may be affected by interference. Please use CATV net or outdoor aerial.
- For safety, install an external aerial conforming to AS1417.1 (applicable for Australia only)
- If there are noise appearance in the picture of VHF-Low band channel, please use the double-shielded cable (not provided) for RF LEADS to reduce the noise.

## CONNECTION (continued)

### Connecting Procedure (continued)

#### 3. Connecting to External Equipment

##### • Terminals on Rear

**AV1 and AV2** can be connected to the equipment with either Component or Composite output. Depending on whether the Y/VIDEO input of your selected equipment is Y signal or Video signal, it automatically regards as Component or Composite. When using as Composite, do not insert the jacks into P<sub>B</sub> or P<sub>R</sub>.

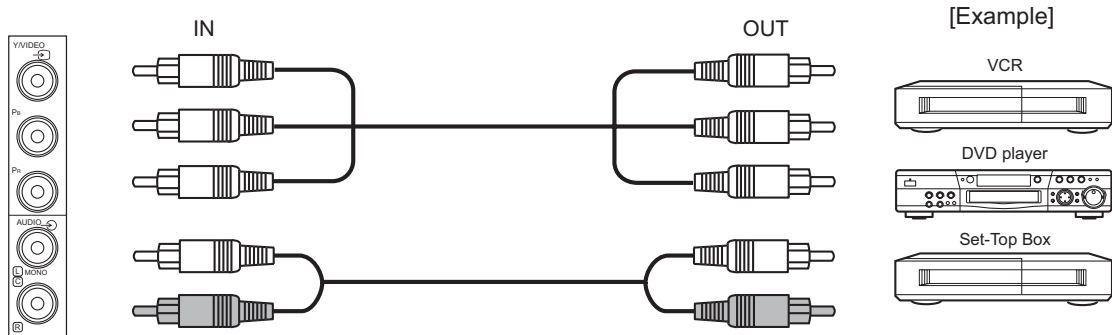

ⓘ If your external device has a Component terminal, COMPONENT connection is recommended for higher quality picture.

**AV3** can be connected to the equipment with an S-Video output and Composite output.

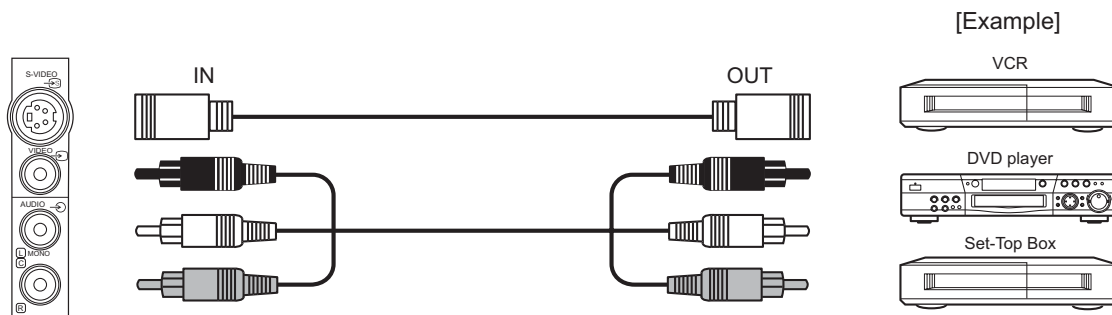

ⓘ If your external device has a S-video terminal, S-VIDEO connection is recommended for higher quality picture.

**AV4** can be connected to the equipment with composite output.

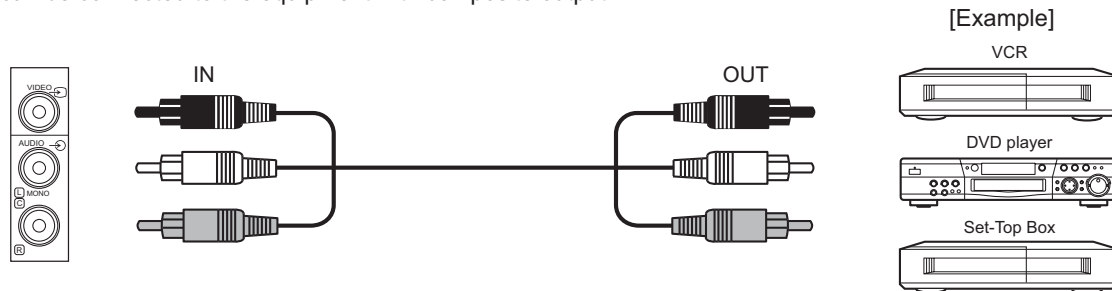



## CONNECTION (continued)

### Connecting Procedure (continued)

**Monitor Out** can be used to display same image as main unit on another monitor.

When this output terminal is connected to an external monitor with a 75 Ohm terminal, the same image from composite(AV1~5), or S-Video(AV3,5), or RF signal can be displayed to the external monitor.

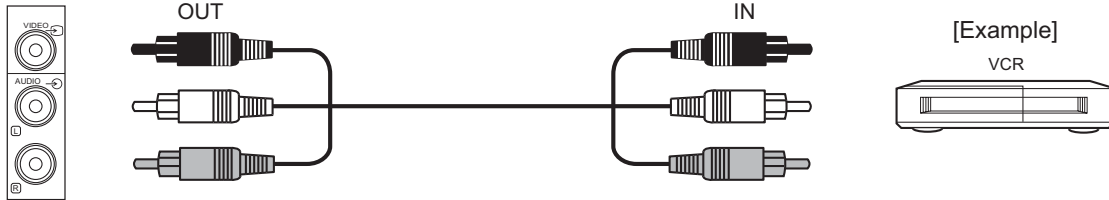

**Sub Woofer** terminal can bring the deep bass sound from the external speaker.

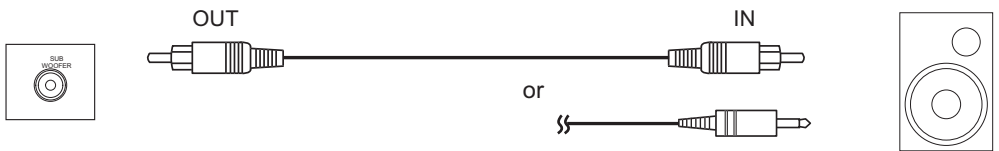

**PC terminals** (D-sub 15 pin + audio) is connected to PC, which allows Analog RGB signal.

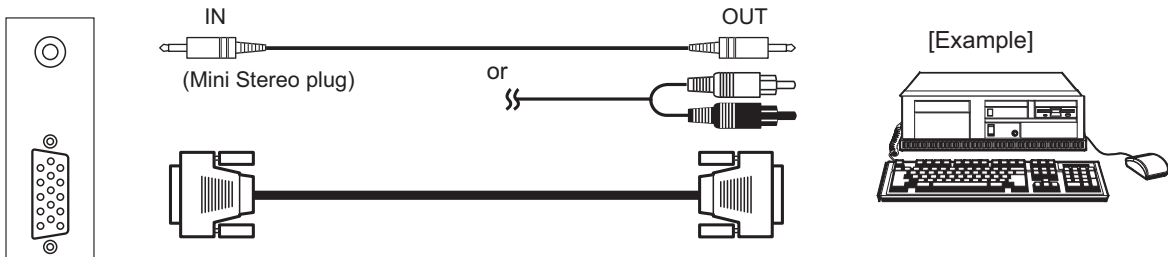

**HDMI 1·2** terminals can be connected to the devices with HDMI output, or if the external device has DVI output, this can be available with HDMI-DVI conversion cable. In case of using the HDMI-DVI, connect to audio terminal besides HDMI.

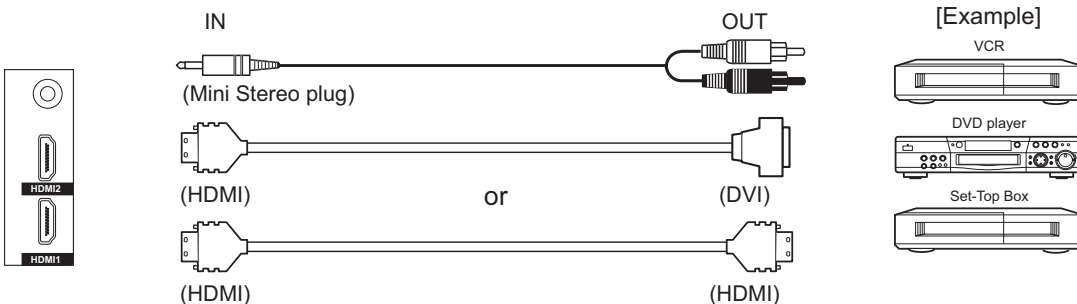

### Information

HDMI(High Definition Multimedia Interface) is next-generation multimedia I/O interface. Only one cable is used to transmit all video/audio/control signals, which creates easy connection.

Moreover, those digital signals can produce high quality data without any degradation.

You are provided two HDMI terminals, one of the most remarkable features.

☞ If your external device has a HDMI terminal, HDMI connection is recommended for higher quality picture and sound.

#### NOTE

- When both HDMI 1 and HDMI 2 terminals are connected to devices via HDMI-DVI conversion cable, HDMI 2 has a priority over the audio terminal.

## CONNECTION (continued)

### Connecting Procedure (continued)

#### • Terminals on Side

Since the following terminals are located on the side, it is very convenient to use the extra device on a temporary basis after done the connections on the rear panel.

AV5 can be connected to the equipment with an S-Video output and composite output.

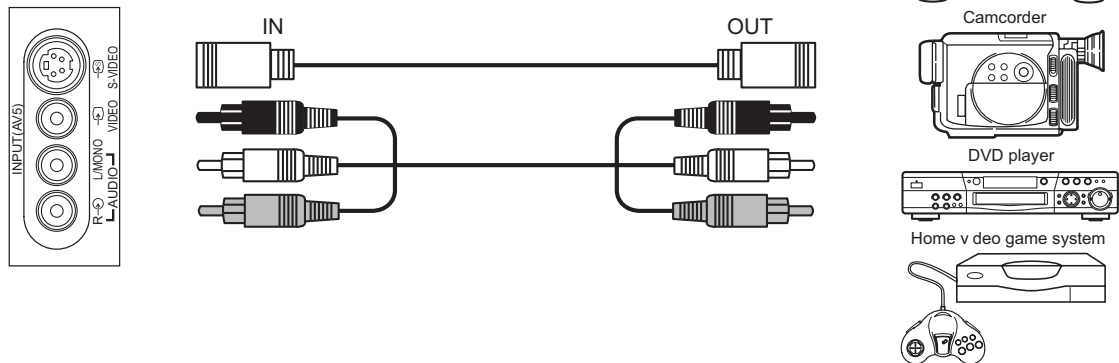

If your external device has a S-video terminal, S-VIDEO connection is recommended for higher quality picture.

**Headphone** The detail settings can be adjusted from Audio Menu on page [35](#).

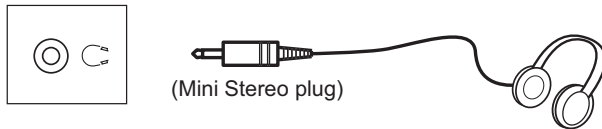

The audio from the speaker will be muted when connecting the headphone to this terminal.

**Photo Input** terminal can be connected to digital still camera or USB card reader with USB cable. For details, refer to the Photo Input function shown on [45](#)~[50](#).



**SD Memory Card slot** can be used for the Photo Input function with the SD (or MMC) card memory containing pictures. For details, refer to the Photo Input function shown on [45](#)~[50](#).

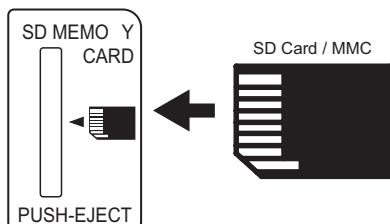

## CONNECTION (continued)

### Connecting Procedure (continued)

#### 4. Connecting the plug into the wall socket

Connect the Power Cord after completing all other connections.  
(The type of plug is different from this drawing for some countries.)

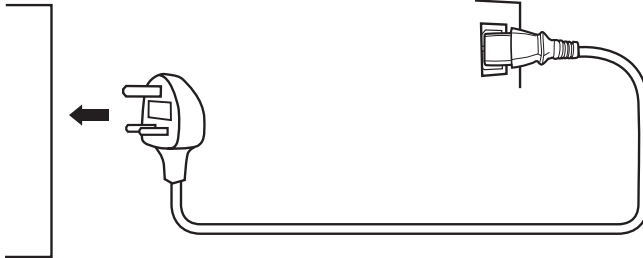

#### ⚠ CAUTION

- Use only the Power Cord provided.
- Do not use a power supply voltage other than that indicated (AC100-240V, 50/60Hz). It may cause fire or electric shock.
- For the plasma display, a three-core power cord with a ground terminal is used for efficiency protection. Always be sure to connect the Power Cord to a three-pronged grounded outlet and make sure that the cord is properly grounded. If you use a power source converter plug, use an outlet with a ground terminal and screw down the ground line.
- Ensure that both ends of power cord are easily accessible.
- If you have to change the power cord, please use the certified power cord that meets your region's safety standard.

#### 📖 Information

##### • How to secure the cables.

After connecting all of the cables to the terminals, secure them with the band.  
When you secure the cables, please be careful not to tighten too much.

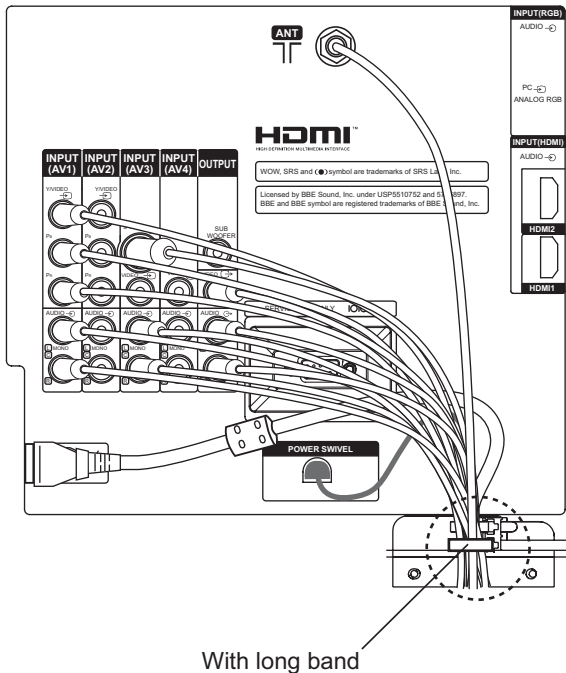

#### How to fasten the band:

##### • To tighten

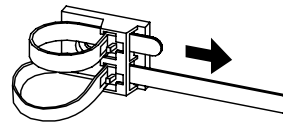

Pull the band in the direction of the arrow.

##### • To loosen

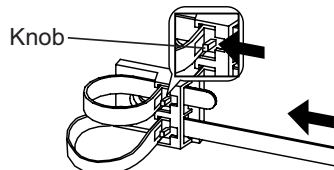

Loosen the band by pushing the knob in the direction of the arrow.

## BASIC OPERATION

### Power On/Off

Now, turn On the main power of the unit. Make sure that the Power Cord has plugged into the wall socket.

#### • To turn On the power of the unit:

1. Press the **Main Power switch** on the unit.
  - The Indicating Lamp will illuminate in **Red** (Standby mode).
2. Press **Sub Power** button either on the control panel or on the remote control.
  - The color of the Indicating Lamp turns into **Green**, and the image will display on the screen.

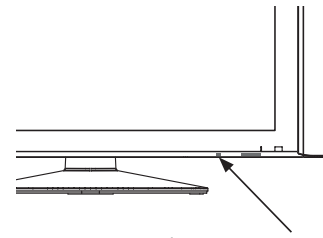

Main Power switch (on the bottom surface)

#### • To turn Off the power of the unit:

1. Press **Sub Power** button either on the control panel or on the remote control.
  - The image disappears from the screen and the Indicating Lamp turns into **Red** (Standby mode).
2. Press **Main Power switch** to completely turn Off the power of the unit.

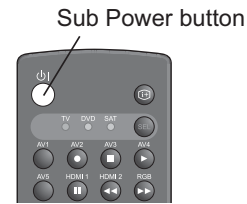

Sub Power button

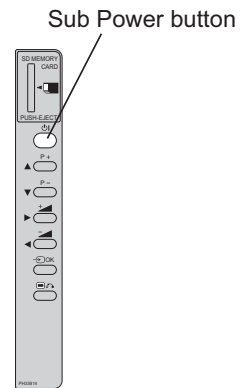

Sub Power button

### The Indicating Lamp Status Check

Indicating Lamp Status	Power Status	Power Switch Status
Off	Off	Main power → Off
Red	Standby mode	Main power → On Sub Power button → Off
Green	On	Main power → On Sub power button → On
Orange	Power Save mode*	Main power → On Sub Power button → On

\*About Power Save mode, see “Power Save Mode” and “When Following Messages Appear on the Screen” on [52](#) and [54](#) for details.

#### NOTE

- If the image does not appear on the screen at all, or have any problem, see TROUBLESHOOTING on [54](#)~[56](#). It may help you to solve the problems.
- You can turn ON the power only by pressing the **Sub Power** button during the Standby mode.
- Do not switch the power On/Off repeatedly in a short period of time. It could cause malfunction.
- To avoid sudden surges of electricity when the power comes back on, turn Off the main power of the unit before you leave if there is a blackout during use of the unit.

## BASIC OPERATION (continued)

### First Time Setup

When you turn ON the TV for the first time, your TV automatically leads to the settings of “Language” and “Auto Tuning.”

1. The first screen appeared will ask you to choose the language of your TV's display.
2. Select the language you preferred from the list and press  button.
3. Once selecting the language, “Auto Tuning” screen appears to start scanning channels.

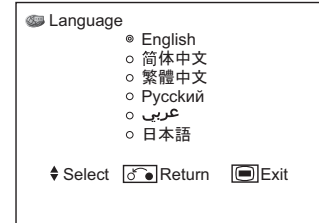

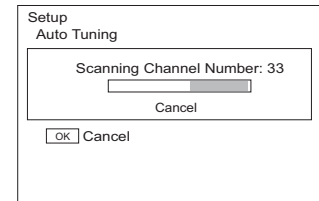

#### NOTE

If you want to change the setting after completing this first time setup, press  button and set up individually. Refer to [21](#) [22](#) .



### Volume UP/DOWN



1. To increase the sound volume, press  button on the remote control, or **Volume Up** button on the control panel.
  - The Volume Indicator value on the screen will shift right.
2. To decrease the sound volume, press  button on the remote control or **Volume Down** button on the control panel.
  - The Volume Indicator value on the screen will shift left.



Volume Up/Down button

Mute button

### Mute

1. To mute the sound, press  button on the remote control.
  - The sound of the unit is temporarily turned Off.
  - The color of the Volume Indicator will turn into **magenta** while muting the volume.
2. To turn the sound back, press  button again, or Volume Up button on either remote control or the control panel.
  - The color of the Volume Indicator will turn back to **green**.

#### NOTE

- You can decrease the volume by pressing  button while muted the volume.

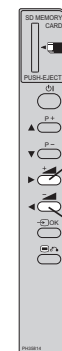

Volume Up button

Volume Down button



The Volume Indicator

## BASIC OPERATION (continued)

### Input Switching to TV/AV1~5, HDMI, and RGB

By pressing Input Select button, you can switch the input.

- To watch actual broadcast, press Input Select button on the control panel, the numeric buttons or Channel Up/Down button on the remote control.
- To display the image outputting from the external equipments connected to each terminal (AV1~5, HDMI 1, 2, and RGB), select corresponding mode.

1. Press **Input Select** buttons on the remote control.

2. The Input modes can be also switched by using **Input Select** button on the control panel.

Each time this button is pressed, the screen displays corresponding mode by following order.

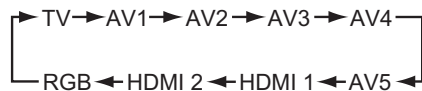

3. To directly go back to TV mode, pressing channel Up/Down buttons on either remote control or the control panel.

Also, you can use the numeric buttons on the remote control.

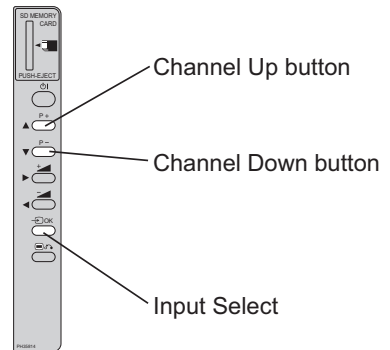
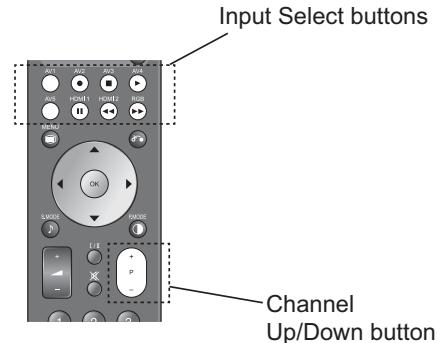

ENGLISH

### Input Signal Screen Display

The input signal status can be displayed on the screen by pressing the button of the remote control.

- The display will go out in approximately 6 seconds.

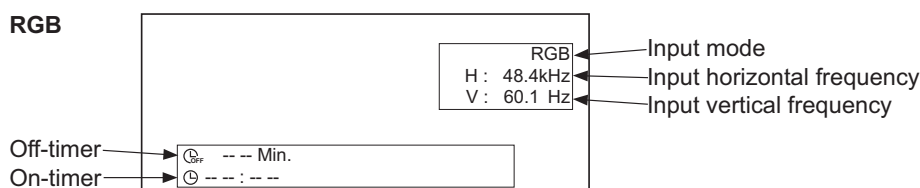
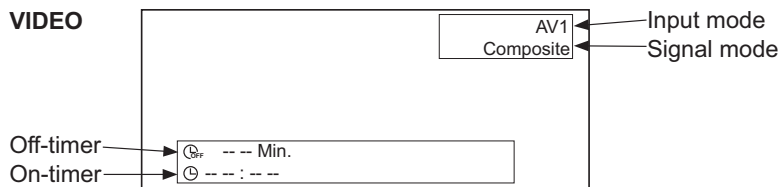
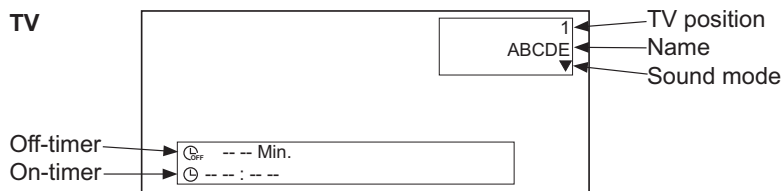





## MENU OPERATION

### How to use the On-Screen Display (OSD) system

With the On-Screen Display system, you can access the various kinds of the features and functions in this product.

#### • Basic Operation

1. Press  button on the remote control or **Menu** button on the control panel of the unit. The **Main Menu** is displayed on the screen as shown on the right.
2. To select the item, press **▲** or **▼** buttons.  
The selected item will be highlighted in Green.
3. Press  button to set your selection.  
The selected menu page will be displayed on the screen.
4. Use **▲** or **▼** buttons to choose the item on the MENU page.  
Press  button to set your selection.
5. Use **◀** or **▶** buttons to adjust the item values or choose options.  
Press  button to set your selection.

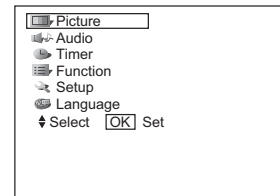

<Main Menu>

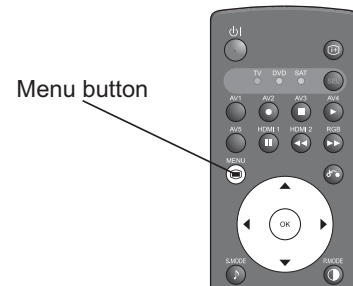

6. To exit from the menu, press  button.

#### NOTE

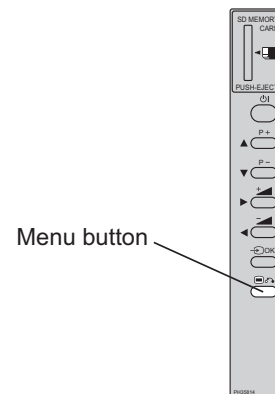

The OSD menu screen will be closed automatically when no operation has been made for about one minute.



### Language Menu

Select the language from the list so that you can display the OSD menu in the selected language.

#### How to set Language

1. Enter the "Language" menu from the Main Menu.
2. Select the appropriate language with **▲** or **▼** button from the list.  
The selected item will be highlighted in Green.
3. Press  button to set your selection.  
The black dot is marked inside of the circle when the selection is fixed.
4. Press  button to exit from the entire OSD menu.

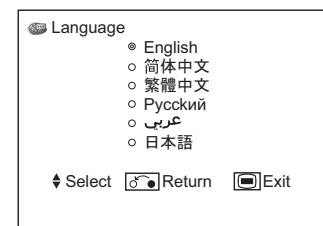

## MENU OPERATION (continued)

### Setup Menu (TV mode)

With this menu, you can access various kinds of features relating to TV channel settings.

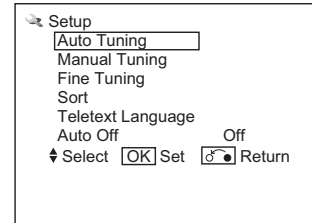

ENGLISH

Selected Items			Setup hint	
Auto Tuning	Mode	Position	Select the way to display the channels on the screen. The position numbers are displayed on the screen. (1~199, AV00)	
		Direct	The channel number 0~99 are displayed as C* *, and the channel number 100~199 are displayed as S* *.	
	Search		Tune the local channels automatically. Press  button to start searching.	
Manual Tuning	Position		Press channel up (+)down(-) buttons to input position number (1~199, AV00) or channel number (C* * or S* *).	
	Frequency		When Auto Tuning Mode is set to [position], search the frequency by using ◀▶ buttons. When Auto Tuning Mode is set to [Direct], this function is not available (grayed out).	
	Name		1. Move the cursor to the first digit and select the letters with ▲▼ buttons. 2. Move to the next digit with ▶ button. 3. Press  button again when you finish inputting all the letters. • The selectable letters are as follows: "0"~"9", "A"~"Z", "+", " " (blank), "-" (displayed as blank), and "." (period).	
	Sound System	Auto		Select the sound system from 5 different modes.
		M		
BG				
I				
DK				

#### Information

- AV00 is useful when connecting to equipments such as VCR which its antenna terminal can output the specified channel frequency.



## MENU OPERATION (continued)

### Setup Menu (TV mode) (continued)

Selected Items		Setup hint	
Manual Tuning	Color System	Auto	Select color system from 5 different modes.
		PAL	
		SECAM	
		NTSC4.43	
		NTSC3.58	
	Skip	Off	It allows you to skip unregistered channels automatically when you use channel up (+) down (-) buttons to select channels. Regarding the unavailable channels, this function will be set to [On] automatically to skip.
		On	
	NR	Off	The noise on the screen or interference could be reduced, especially at the area of weak electric field.
		On	
	Antenna Att.	Off	The noise on the screen or interference could be reduced in case that the receiving airwaves are too strong. • The selection on this item is applied to all the channels.
On			
Fine Tuning	-56~+56	▶ : Increase the frequency data for the main tuner. ◀ : Decrease the frequency data for the main tuner.	
Sort		You can change the order of channels as follows. 1. Move the cursor to the Channel row you want to change order and then, press <b>OK</b> button. 2. The color of the letters on the designated line will be turned into green bracket and with [ ]. 3. Move the designated row by using <b>▲ ▼</b> buttons. 4. Press <b>OK</b> button to fix the position. • This function is not available (grayed out) when the Auto Tuning Mode is set to [Direct].	
Teletext Language		Select Teletext Language from 4 different categories (West Europe, East Europe, Cyrillic, and Arabic) according to the area. Example: West Europe : Asian countries where the Teletext is broadcasting in English such as Singapore, Australia, and Malaysia. East Europe : Poland, Sweden, Hungary Cyrillic : Russia Arabic : Arab countries	
Auto Off		Off : When no airwave has been received and no operation has been made for 10minutes in TV mode, it turns to standby mode automatically. On	

## MENU OPERATION (continued)

### Setup Menu (AV mode)

With this menu, you can select or adjust the condition of the input signals from each terminal.

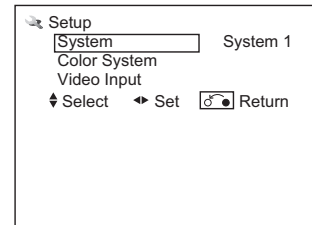

ENGLISH

Selected Items			Setup hint	
<b>System</b>	System 1		Do not change the original setting. (System1: Europe/Asia, System2:North America) • Composite and S-video input only.	
	System 2			
<b>Color system</b>	AV1~AV5	System 1	Auto	Select the color system depending on the input signal. • Generally, select [Auto]. • In case that the input signal has too much noise, the signal level is too low, or the operation is unstable in [Auto], select the system according to the color system of the input signal. • Composite and S-video input only.
			PAL	
			SECAM	
			NTSC4.43	
			NTSC3.58	
		System 2	Auto	
			NTSC-M	
PAL-M				
		PAL-N		
<b>Video Input</b>	AV1, AV2	Auto	Select the colorimetry depending on the input signal. • Generally, select [Auto]. • In case that the input signal has too much noise, the signal level is too low, or the operation is unstable in [Auto], set this to match the input signal. • Component Input only.	
		HDTV		
		SDTV/DVD		

## MENU OPERATION (continued)

### Setup Menu (RGB mode)

With this menu, you can adjust the display condition of the image which is inputting from the RGB terminals. By pressing ▼ button at the bottom of the 1st Setup menu page, the 2nd Setup menu page will appear on the screen.

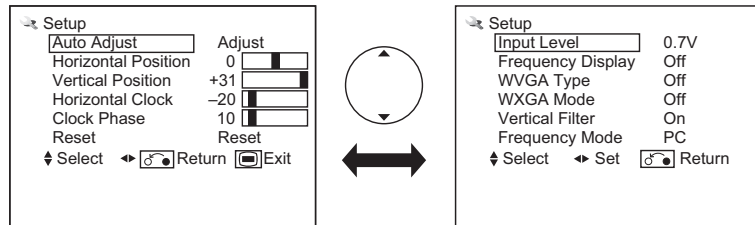

Selected Items		Setup hint
<b>Auto Adjust</b>		Adjust Horizontal Position, Vertical Position, Horizontal Clock, and Clock Phase automatically. <ul style="list-style-type: none"> <li>• Press (OK) button to start auto adjustment. The message "Auto Adjusting" is displayed.</li> <li>• Depending on the type of the signal, there is a possibility that the display may not be adjusted in its optimum condition with this function. In that case, please adjust each item manually.</li> </ul>
<b>Horizontal Position*</b>	-63~+63	Adjust the display position horizontally. <ul style="list-style-type: none"> <li>• When the position exceeds the possible range, the display color will turn into Magenta.</li> </ul>
<b>Vertical Position*</b>	-31~+31	Adjust the display position vertically. <ul style="list-style-type: none"> <li>• When the position exceeds the possible range, the display color will turn into Magenta.</li> </ul>
<b>Horizontal Clock*</b>	-31~+31	Minimize the vertical stripes on the screen.
<b>Clock Phase*</b>	0~63	Minimize the blurring of the letters and stripes on horizontal row. <ul style="list-style-type: none"> <li>• Make sure to adjust <u>Horizontal Clock first</u> before adjusting Clock Phase.</li> </ul>
<b>Reset</b>		Reset all the set values on this Menu page to original factory settings.

## MENU OPERATION (continued)

### Setup Menu (RGB mode) (continued)

Selected Items		Setup hint
Input Level	0.7V	<ul style="list-style-type: none"> <li>• Normally, select [0.7V].</li> <li>• Select [1.0V] only when the whole display becomes too white.</li> </ul>
	1.0V	
Frequency Display	Off	Select whether indicating the PC signal frequency information on Input Signal Screen Display or not.
	On	
WVGA Type	Off	It allows you to switch display size to [Full] and [Real]. (See “Size Switching” on <a href="#">39</a> for the details.) <ul style="list-style-type: none"> <li>• This function is available only for WVGA signal.</li> <li>• Refer to “Recommended Signal List” on <a href="#">59</a>.</li> </ul>
	On	
WXGA Mode	Off	<ul style="list-style-type: none"> <li>• This function is available only for WXGA signal.</li> <li>• Refer to “Recommended Signal List” on <a href="#">59</a>.</li> </ul>
	1280x768	
	1366x768	
Vertical Filter	Off	Reduce the flickers on the screen when set to [On].
	On	
Frequency Mode	PC	Select [Movie] when you see the moving image on PC.
	Movie	

#### Information

- The items indicated by “\*” can be automatically stored the setting depending on the signal mode.
- The signal mode is identified by the Horizontal/Vertical frequency and the sync. signal polarity, which has almost same values in all the above items might be regarded as the same signal.
- The item “Auto Adjust” cannot be stored. Press  to start auto adjustment as needed.

## MENU OPERATION (continued)

### Function Menu

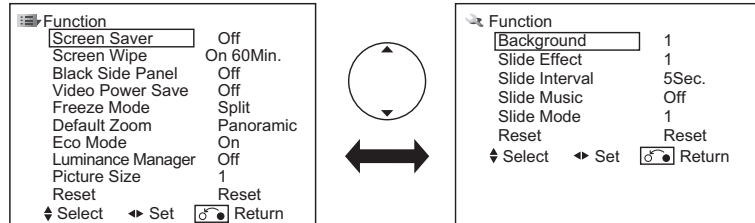

This menu provides various ways to protect your panel, reduce power consumption, and set up utilizing the useful functions, such as Freeze Mode and Photo Input.



Selected Items		Setup hint
<b>Screen Saver</b>	Off	This is one of the initiatives to reduce image retention by moving the displaying screen slightly at set interval. You can select the interval with cursor button.
	5Min.	
	10Min.	
	20Min.	
	40Min.	
	60Min.	
<b>Screen Wipe</b>	On	This displays the white pattern to recover from the image retention. • On : Continuous Operation • 60Min. : Limited Operation for 60 minutes.
	60Min.	
<b>Black Side Panel</b>	Off	This can change the color of sidebars showing up in normal mode. (Off:gray, On:black) It is recommended to set Off to reduce image retention. Please note that it is not available while operating Photo Input function.
	On	
<b>Video Power Save</b>	Off	During AV input, this helps to reduce power consumption when there is no video signal. In case of selecting AV input terminal which does not have signal input, it changes the power status to power save mode in AV1/AV2 and standby mode in other AV input. (See <a href="#">52</a> in details.)
	On	
<b>Freeze Mode</b>	Split	This is the useful function to watch the program in both still and active pictures. (See <a href="#">44</a> in details.) • Split: half sized images • Strobe: thumbnail sized images
	Strobe	
<b>Default Zoom</b>	Panoramic	You can set the display size for TV / AV input screen appearing first when turning the main power On.
	4:3	
	Full	
<b>Eco Mode</b>	Off	This can reduce the power consumption.
	On	

## MENU OPERATION (continued)

### Function Menu (continued)

Selected Items		Setup hint
Luminance Manager	Off	This helps to avoid the image retention such as station logo by lowering the brightness of 4 corners.
	On	
Picture Size	1	In case that the image from TV signal (especially CATV) has a blackened gap in either or both side during Panoramic mode, select [2] so that it can make up for the gap. This is not available when displaying "Cinema" size. This is not available except RF, composite, and component (576i,480i) input. (gray out)
	2	
Reset		Each item on this menu screen can be restored to the original factory settings by pressing  button.
Background	1	This is available only for Photo Input function. Switch the pattern of background. See details on <a href="#">49</a> .
	2	
Slide Effect	Off	This is available only for Photo Input function. You can select the method of switching slides during slide show. See details on <a href="#">47</a> .
	1	
	2	
Slide Interval	5Sec.	This is available only for Photo Input function. You can select the interval time for switching slides during slide show. See details on <a href="#">47</a> .
	10Sec.	
	30Sec.	
Slide Music	Off	This is available only for Photo Input function. You can select the preferred Background Music during slide show. See details on <a href="#">47</a> .
	1	
	2	
Slide Mode	1	This is available only for Photo Input function. You can select where to start the slide show. See details on <a href="#">47</a> .
	2	
Reset		Each item on this menu screen can be restored to the original factory settings by pressing  button.

#### Information

- The item "Screen Wipe" cannot be stored.  
Select "On" or "60 Min." to conduct this function as needed.

## MENU OPERATION (continued)

### Picture Menu (TV/AV mode)

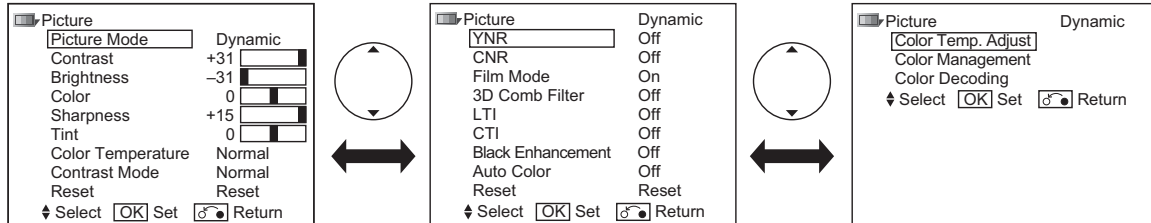

In this menu, you can make specific adjustments for the picture based on your preference.  
By pressing ▼ button at the bottom of each menu page, the next Picture menu page will appear on the screen.



Selected Items		Setup hint
<b>Picture Mode</b>	Dynamic	You can make the better selection from 3 modes depending on the lighting condition and intended use. Dynamic: Suitable for the brighter conditions. Natural : Suitable for the normal lighting condition. Cinema : Suitable for watching movie.
	Natural	
	Cinema	
<b>Contrast*</b>	-31~+31 (+32~+40)	This adjusts the contrast to meet the lighting environment by using ◀▶. • The maximum value can be extended to [+40] by pressing and holding ▶ button at [+31], which changes the color between those numbers from green to magenta. This is the special feature prepared for the dark scene. At the normal condition, it is recommended to set the value less than [+31].
<b>Brightness*</b>	-31~+31	With this function, black is adjusted to change the overall brightness by using ◀▶.
<b>Color*</b>	-31~+31	It can adjust color density based on your preference by using ◀▶.
<b>Sharpness*</b>	-15~+15	Preferred sharpness can be adjusted by pressing ◀ button for Softer image or ▶ button for Sharper image.
<b>Tint*</b>	-31~+31	Pressing ◀ button enhances red and weakens green, while pressing ▶ button weakens red and enhances green. The setup hint is adjusting for the realistic skin color.
<b>Color Temperature*</b>	Cool	You can select from 4 settings (default) depending on the color condition with ◀▶ buttons.
	Normal	
	Warm	
	Black/White	

## MENU OPERATION (continued)

### Picture Menu (TV/AV mode) (continued)

Selected Items		Setup hint
<b>Contrast Mode*</b>	Dynamic	It allows you to choose from 3 modes. Dynamic: Sharpen the gradation to improve the contrast feeling. Normal: Reproduce as faithful gradation as possible. Auto: Adjust to natural brightness without blurred white by detecting the bright parts on images.
	Normal	
	Auto	
<b>Reset</b>		Each item on this menu screen can be restored to the original factory settings by pressing  button.
<b>YNR*</b>	Off	This is a noise reduction system for picture signal.
	Low	
	High	
<b>CNR*</b>	Off	This is a noise reduction system for color signal.
	Low	
	High	
<b>Film Mode*</b>	Off	On: Automatically identify if it is the movie film and faithfully reproduces the original film images. Off: Set to Off if the image does not look natural during turning on.
	On	
<b>3D Comb Filter*</b>	Off	This is available only when receiving NTSC/PAL composite signal. This reduces the dot and color blurring in minute scales so that it can reproduce purer color.
	Low	
	High	
<b>LTI*</b>	Off	Adjusts the sharpness of the picture signals.
	Low	
	Middle	
	High	
<b>CTI*</b>	Off	Adjusts the sharpness of the color signal.
	Low	
	Middle	
	High	
<b>Black Enhancement*</b>	Off	Adjusts the black level compensation.
	Low	
	Middle	
	High	
<b>Auto Color*</b>	Off	This monitors and adjusts the color to maintain constant color levels. It also maintains natural flesh tones while preserving fidelity of background colors. This is available only when receiving an NTSC composite and S.Video signal.
	On	
<b>Reset</b>		Each item on this menu screen can be restored to the original factory settings by pressing  button.



## MENU OPERATION (continued)

### Picture Menu (TV/AV mode) (continued)

Selected Items		Setup hint	
Color Temp. Adjust**	On	Amplitude	On: When you want to set specific adjustments in each of the 4 Color Temperature modes. You can adjust on the amplitude and cut off. The settings reflect on the Color Temperature. Amplitude: subdue the following colors on the brighter parts. Cut off : subdue the following colors on the darker parts.
		Red	
		Green	
		Blue	
		Cut off	
		Red	
		Green	
	Blue		
Off		Off: Remains as default setting.	
Color Management**	On	Magenta	On: Turn On to adjust the balance of each colors depending on the user's preference. The settings reflect in each of the 4 Color Temperature modes. Off: Remains as default setting.
		Red	
		Yellow	
		Green	
		Cyan	
	Blue		
Off			
Color Decoding	RGB/R/G/B	This can adjust R/G/B level and tint to make the color appear naturally for the user's appearance. First, select RGB (multiple color screen) or R/G/B(single color screens) to check the color decoding effects while adjusting. Then, you can adjust the level of color (red and green), color intensity, and tint. Press  to save the setting. The settings reflect in each of the 4 Color Temperature modes.	
	Red**		
	Green**		
	Tint*		

#### Information

The items indicated by “\*” can be stored the setting for each of inputs and picture modes (Dynamic/Natural/Cinema). You can enjoy different setting depending on the selected input such as VCR in AV1.

In addition, the items indicated by “\*\*” can be stored the setting for each of color temperature modes.

## MENU OPERATION (continued)

### Picture Menu (RGB mode)

In this menu, you can make specific adjustments for the RGB picture based on your preference.

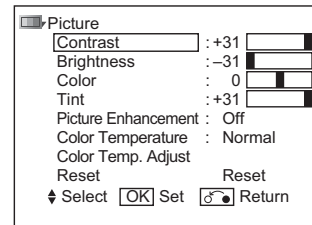

Selected Items		Setup hint
<b>Contrast</b>	-31~+31 (+32~+40)	This adjusts the contrast to meet the lighting environment by using ◀▶. • The maximum value can be extended to [+40] by pressing and holding ▶ button at [+31], which changes the color between those numbers from green to magenta. This is the special feature prepared for the dark scene. At normal condition, it is recommended to set the value less than [+31].
<b>Brightness</b>	-31~+31	With this function, black is adjusted to change the overall brightness by using ◀▶.
<b>Color</b>	-31~+31	It can adjust color density based on your preference by using ◀▶.
<b>Tint</b>	-15~+15	Pressing ◀ button enhances red and weakens green, while pressing ▶ button weakens red and enhances green. The setup hint is adjusting for the realistic skin color.
<b>Picture Enhancement</b>	Off	You can select the preferred sharpness on detailed parts.
	Low	
	Middle	
	High	
<b>Color Temperature</b>	Cool	You can select from 4 settings (default) depending on the lighting condition with ◀▶ buttons.
	Normal	
	Warm	
	Black/White	

## MENU OPERATION (continued)

### Picture menu (RGB mode) (continued)

Selected Items		Setup hint	
Color Temp. Adjust.**	On	Amplitude	On: When you want to set specific adjustments in each of the 4 Color Temperature modes. You can adjust on the amplitude and cut off. The settings reflect on the Color Temperature. Amplitude: subdue the following colors on the brighter parts. Cut off : subdue the following colors on the darker parts.
		Red	
		Green	
		Blue	
		Cut off	
		Red	
		Green	
	Blue		
	Off	Off: Remains as default setting.	
Reset	Each item on this menu screen can be restored to the original factory settings by pressing  button.		

#### Information

There is a useful function to automatically store the setting on menu in almost every item so that you do not have to reset every time. Furthermore, the following items can be stored more specifically.

In addition, the items indicated by “\*\*” can be stored the setting for each of color temperature modes.

## MENU OPERATION (continued)

### Audio Menu

With this menu, you can adjust and customize the audio condition as you like. You can move on to the next menu screen by pressing ▼ button at the bottom.

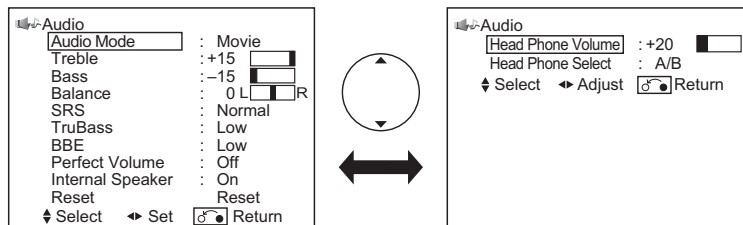

ENGLISH

Selected Items		Setup hint
<b>Audio Mode</b>	Movie	You can select the most suitable sound condition from 4 alternatives according to the contents. If you want to adjust each item value based on your preference, select "Favorite".
	Music	
	Speech	
	Favorite	
<b>Treble**</b>	-15~+15	Adjust the Treble of the sound.
<b>Bass**</b>	-15~+15	Adjust the Bass of the sound.
<b>Balance</b>	-10~+10	Adjust the balance of the sound comes out from right and left side of the speakers.
<b>SRS</b>	Off	This system gives you the dynamic 3D sound. Select it depending on your preference.
	Normal	
	Wide	
<b>TruBass</b>	Off	TruBass gives you the enhanced bass sound. Select it depending on your preference.
	Low	
	High	
<b>BBE</b>	Off	BBE High Definition Sound restores clarity and presence for better speech intelligibility and musical realism. Select it depending on your preference.
	Low	
	High	
<b>Perfect Volume**</b>	Off	It will automatically adjust the volume to its average level each time you change the channel.
	On	
<b>Internal Speaker</b>	Off	This needs to be switched to Off when you want to take audio from external equipment.
	On	It normally sets to On when you operate this unit with the equipped speaker.
<b>Reset</b>		Reset all the set values on this Menu Page to the original factory settings.

## MENU OPERATION (continued)

### Audio Menu (continued)

Selected Items		Setup hint
Headphone Volume	0~63	It allows you to adjust the volume of the headphone. The sound from the speaker will automatically set to MUTE when the headphone is connected to the terminal.
Headphone Select	A/B	Select the either side of the display that you want to hear the sound with headphone during 2-picture mode. (See "Multi Picture Mode" on <a href="#">41</a> ) • A/B : You can select either side A (left side) or side B (right side) which the sound comes into the headphone. The speaker icon will be displayed on the side you select.
	B	• B : You will hear the sound only from the side B (right side) of the display.

#### NOTE

The headphone is NOT available when the image from the RGB or Photo Input is on the screen.

#### Information

There is a useful function to automatically store the setting on menu in almost every item so that you do not have to reset every time. Furthermore, the following items can be stored more specifically.

The items indicated by "★★" can be stored the setting for each of Audio Mode.

### Timer Menu

This allows the unit to turn Off (Standby mode) or On at set time automatically, which you may find useful.

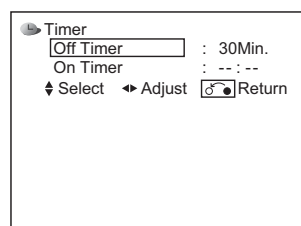

Selected Items		Setup hint
Off Timer	--Min.	This function automatically sets the power to Standby mode when the selected time period has elapsed.
	30Min.	
	60Min.	
	90Min.	
	120Min.	
On Timer	--:--	This function automatically sets the power from standby mode to On when the specified time period has elapsed. Input the desired time within the range of 00:00 to 11:59 by using ▲ ▼ button on the remote control.

# FUNCTION

## Power Swivel

With the optional Desktop stand, you can adjust the angle of the panel side to side by pressing  button on the remote control.

1. Press  button on the remote control.  
The Swivel Display (as shown in the figure on the right) will appear on the screen.
2. Adjust the angle of the panel with ◀ ▶ keys while Swivel Display is on the screen.  
The monitor will be able to move ±30 degrees to each side.

### CAUTION

- When you use the Power Swivel function, make sure that the Power Cord, cord or chain connected to the wall is loose enough to operate the Swivel function securely.
- Do not put hands or faces near the unit while operating the Swivel. It could cause personal injury. Beware especially when small children are around the unit.

### NOTE

- If the stand cable is not connected to the unit, the message "Not Available" will appear on the screen.
- The Swivel Display will automatically disappear when no operation has been made for about 6 seconds.

### CAUTION

- Do not push the panel with your hands while operating the Swivel. It could damage the panel and/or stand.
- Do not allow children to play or hang on the TV. These actions may tip it over, causing personal injury.
- Do not swing the monitor back and forth.
- Do not place any fragile objects around the unit. The monitor would hit the object(s) during the Swivel operation and could cause the breakage of the objects and/or the stand.
- To operate the Swivel function correctly, place the monitor on the stable surface.
- When you use the unit as wall-mounting, disconnect the stand cable from the monitor before installation.

### Information

About Swivel terminal connection

- To connect the Desktop stand to the unit  
Connect the designated stand cable to the Swivel terminal on the rear side of the unit.

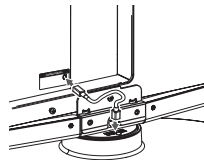

- To disconnect the stand from the unit.  
Before detach the stand from the unit, make sure to disconnect the stand cable from the Swivel terminal on the rear side of the unit.

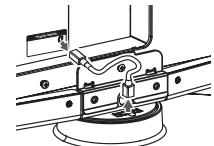

### CAUTION

- When you install the Desktop stand, follow the Instructions of the Manual included with the stand.
- Turn Off the Main Power of the unit when connecting or disconnecting the stand cable to the unit.

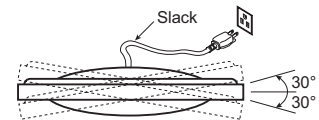
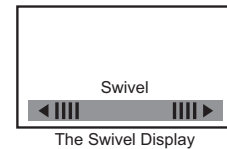
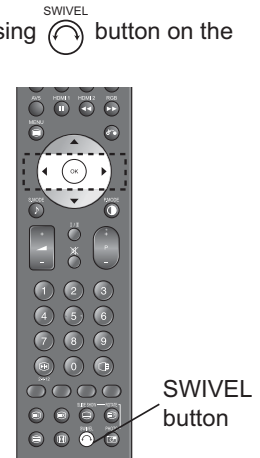

## FUNCTION (continued)

### About Teletext

#### • What is “Teletext”

Teletext is the written information services provided by each TV channel. Most TV channels provide information via Teletext such as:

- TV program schedule
- Weather forecasts
- Sports results
- Newsflash

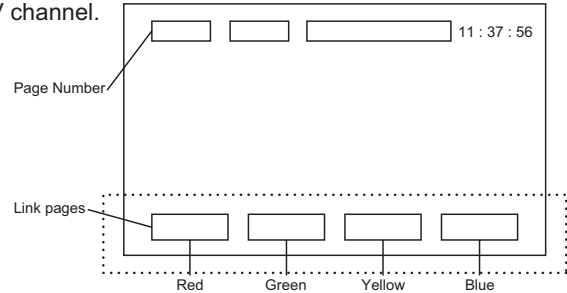









#### • How to operate the Teletext

You can display the Teletext simply by pressing the remote control buttons.



##### NOTE

Select Teletext language from Setup Menu shown on **23**.

Operation	Press
To activate Teletext mode. To exit from the Teletext mode.	 [TV⇔Text]
To split the screen into two and watch both Teletext information and actual broadcast at the same time. Press again to watch Teletext on a single screen.	 [Text⇔TV+Text]
To display Index page.	 [Index]
To access Subtitle service directly (if the channel has the Subtitle service broadcasting).	 [Subtitle]
To display Hidden text. ex. The answers of the Quiz or the Game page. Press again to close the revealed answer.	 [Reveal]
To return to actual broadcast temporarily while searching for the Teletext page you request. When the search is done, the designated page # will be displayed on the upper left of the screen. Press again to return to Teletext page.	 [Cancel]
To access the link pages which are displayed at the bottom of the page. (Select the buttons corresponding to the colors of the letters on screen.)	 [Color]
To hold the text picture.	 2-4-12 [Hold]



#### Information

- Each time the  button is pressed, the screen will be switched from double screen to signal screen.
- Some Teletext pages do not display Link Pages at the bottom of the screen. Press  button to display them.

## FUNCTION (continued)

### Size Switching

Each time  button of the remote control is pressed, the screen display size is switched in sequence, and the status will be displayed at the bottom of the screen.

#### TV/AV signal input

TV/AV1/AV2/AV3/AV4/AV5/HDMI1/HDMI2

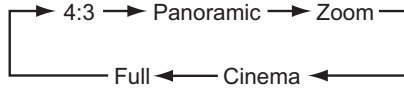



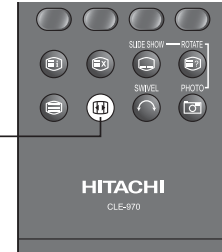

ZOOM button



ENGLISH

You can display the image at optimum condition by selecting display size depending on the current output image as shown below.

Current Output Image (Input Signal)	Display Size	To display suitable screen as follows.
 (4:3 Signal)	4:3	Play a 4:3 image on screen faithfully. Blanking occurs on both sides.
	Panoramic	Play a 4:3 image which enlarges horizontal and vertical size of the middle in equal scales, and displays both sides appearing much wider.
 (Vista)	Zoom	Play a 16:9 image in 4:3 image (Vista size) faithfully. *In some case, slight blanking may remain at the top and bottom.
 (Cinema)	Cinema	Play a 21:9 image in 4:3 image (Cinema size) expanding vertically. *In some case, slight blanking may remain at the top and bottom.
 (Squeeze)	Full	Play a 4:3 image faithfully in the standard vertical size and horizontally squeezed.

#### NOTE

The display size is fixed as follows when receiving 720p or 1080i signal.





- 720p : Full
- 1080i : Full1 and 2 (See "Size Adjustment" on [39](#) about switching between Full1 and 2.)

#### Information

Aspect ratio represents horizontal : vertical ratio on screen.  
For example, vista image is 16:9 in 4:3 image.

#### Position Adjustment

Vertical picture position can be adjusted for **Panoramic**, **Zoom**, and **Cinema** mode as follows.

1. Press   buttons while operating the picture size display.
2. "Position" display will appear.
3. Adjust the position by   buttons.

Adjustment range of each picture size are as shown below.

**Panoramic:** -12 to +12 (The position cannot be adjusted in Panoramic 2 mode.)

**Zoom and Cinema:** -31 to +31

\*When 1080i/60 component signal is received, it can be adjusted only 0 to +1.

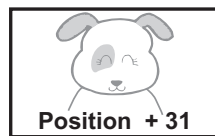
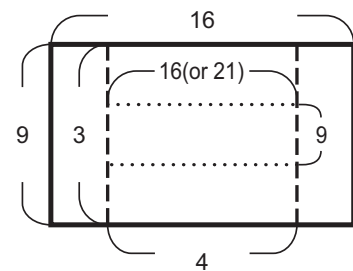

Press 



Press 



## FUNCTION (continued)

### Size Switching (continued)

#### TV/AV signal input

##### • Size Adjustment

###### • Full Mode

While displaying a picture of 1080i format in AV1, AV2, HDMI1, HDMI2, or RGB input, the full mode can be switched further between Full1 and Full2 with  button on the remote control. By selecting Full2, you can see the whole image of 1080i format on the screen display from the input terminals. Depending on the input signal or connecting device, the screen display has unnecessary blanking or noise at the edges. Considering the case, the default setting is Full1 which enlarges the vertical size not to display the blanking and noise.

ZOOM button



#### NOTE

- The screen saver function does not work at Full2 mode.

###### • Panoramic Mode

While displaying a picture except RGB input, the panoramic mode can be switched further between Panoramic 1 and Panoramic 2 with ◀ ▶ buttons on the remote control. By selecting Panoramic 2, the vertical size is scaled down so that you can see the whole image without blanking ; for example, you can see the subtitle at the bottom of screen without lacking.

### CAUTION

#### Using a wide-screen monitor

- This monitor has a screen mode selection feature. If an incompatible screen mode is selected to play certain software, such as a TV program, the image would appear different from the original. Take this into consideration when making screen mode choices.
- Use of the wide feature displaying enlarged pictures in coffee shops, hotel and other establishments for commercial or public viewing purposes could infringe on the copyright holder's right protected by Copyright Law.
- When a normal 4:3 image (not wide screen) is displayed over the entire screen in the Panoramic mode, the peripheral image may disappear partly and/or appear distorted in some cases. Use 4:3 mode to view the image reflecting original intention.

#### RGB signal input

You can select suitable size depending on the resolution.

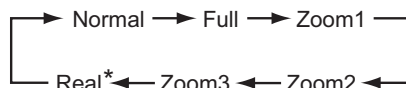

\*Real mode gives the image with same shapes as that of computer monitor.  
This mode is only available for VGA(640x480) and WVGA(864x480).

#### Display Area Selection Diagram

Resolution	Full display	Circular display				
Display	Full	Normal	Real*	Zoom1	Zoom2	Zoom3
640 X 480 (VGA)						
800 X 600 (SVGA)						
1024 X 768 (XGA)						
1280 X 1024 (SXGA)						
1600 X 1200 (UXGA)						

It has been performed processes such as compression (thinning) and enlargement for the above signal display. It may affect flicker to become noticeable on Zoom (1~3) depending on the display contents. To reduce this flicker, turn "Vertical Filter" On from "Setup Menu" (26).

## FUNCTION (continued)

### Multi Picture Mode

With this feature, you can watch different channels simultaneously on one screen in several ways. As for the available signals, please refer to "Recommended Signal List" on [60](#).

**This function is NOT available in HDMI input.**



- To activate Multi Picture mode in either TV, AV, and RGB mode, press  on the remote control.

#### 2-picture mode

You can watch two different pictures side by side. This mode is available in both TV mode and AV mode (AV1~5 Input).

**Control on the side with Speaker Icon**   
Audio is output from the selected picture with the speaker icon. You can switch the Input modes (TV and AV1~5) or change channels only on the side with Speaker icon.



- To shift the speaker icon, press  button.
  - The speaker icon  will be shifted from A to B back-and-forth.
- To change the channel on the selected picture, press .
- To select the Input mode on the selected picture, press **Input Select** buttons on the remote control.

#### NOTE

- In TV mode, you cannot select the same channels on both sides simultaneously.
- You cannot select the same AV input on both sides simultaneously.
- The message "Not Available" will be appeared on the screen when the combinations of the **Input modes** are not acceptable. (See the Table below for details.)

The selected picture with speaker icon

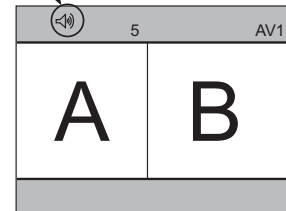

**Table: Mix-and -Match of the Input Modes**

Side A \ Side B	TV	AV1	AV2	AV3	AV4	AV5
TV	○*	○	○	○	○	○
AV1	○	×	○	○	○	○
AV2	○	○	×	○	○	○
AV3	○	○	○	×	○	○
AV4	○	○	○	○	×	○
AV5	○	○	○	○	○	×

\*You cannot select the same TV channels on both sides simultaneously.

## FUNCTION (continued)

### Multi Picture Mode (continued)

#### 2-picture mode (continued)

- To switch to 4-picture mode, press  once.
  - The 4-picture mode is displayed on the screen.

**NOTE** 

Each time  is pressed, the picture mode will be switched by following order.

→ 2-Picture → 2-Picture (1080i)\* → 4-Picture → 12-Picture (TV mode only) →

\* When receiving 1080i format of component signal, there is a mode (2-Picture(1080i)) which sub-screen is displayed inside of the large screen (Main-screen). Please note that you cannot display the picture with component signal on Sub-screen.

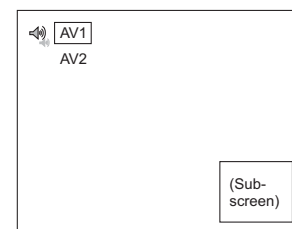

[2-Picture (1080i) Mode]

- To EXIT from the Multi Picture mode, press  button.
  - Next time you press  to activate the Multi Picture mode, it will start from 2-picture mode.

#### 4-picture mode

You can watch 4 different pictures from live broadcasts and/or the external equipments at the same time.

**NOTE** 

- The audio comes out ONLY from side A.
- You can change the channels or change Input modes on the side with ▼ (red triangle) mark.

- To switch the ▼ location
  - Press ◀▶ buttons on the remote control. The ▼ mark will shift to side A and side B back-and-forth.

- To change the channel

Make sure that ▼ mark is located on the side you want to make changes.

Side A: Press  to select channels.

Side B: Select the frame (B1~B3) that you want to make changes with ▲▼ buttons. The selected frame will be highlighted in green.

Press  buttons to select channels.

The selected picture with red triangle mark

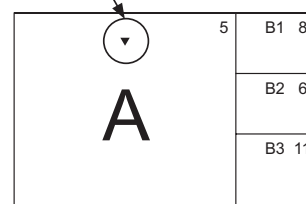

- To change Input mode

Make sure that ▼ mark is located on the side you want to make changes.

Side A: Press **Input Select** buttons on the remote control.

Side B: Select the frame (B1~B3) that you want to make changes with ▲▼ buttons. The selected frame will be highlighted in green. Press **Input Select** buttons on the remote control.



## FUNCTION (continued)

### Multi Picture Mode (continued)

#### 4-picture mode (continued)

**NOTE**

You cannot display the picture with Component signal on Side B screens.

- To EXIT from Multi Picture mode, press  button.
  - Next time you press  to activate the Multi Picture mode, it will start from 4-picture mode.
- To switch to 12-picture mode, press  button.
  - The 12-picture mode is displayed on the screen.

#### 12-picture mode



You can check 12 different live broadcast channels on one screen.

- The channels that are preset in advance (up to 200 channels) will automatically appear in certain intervals.

**NOTE**

- This mode is available only in TV mode.

1	2	3	4
5	6	7	8
9	10	11	12

- To EXIT from the Multi Picture mode, press .
  - Next time you press  to activate the Multi Picture Mode, it will start from 12-picture mode.
- When you press  in this sequence, the 2-picture mode will be displayed.

## FUNCTION (continued)

### Multi Picture Mode (continued)

#### Activate the Multi Picture Mode in RGB Mode

When you activate the Multi Picture mode in RGB Input, the picture will be displayed at the mode which the Sub-screen is displayed inside of the large screen (Main-screen).

- To activate Multi Picture mode, press  on the remote control.

The speaker icon  indicates the following.

- The audio sounds can be heard on the side with the speaker icon.
- When the speaker icon is on the Sub-screen
  - Change channels.
  - Switch the Input modes (TV and AV1~5) on the Sub-screen. (Main-screen is only for RGB Input.)

1. To shift the speaker icon , press  buttons.
  - The speaker icon  will be displayed in front of the Input mode indication.

2. To change the channel of the Sub-screen.
  - Make sure that  mark is located on the Sub-screen.

- Press  to select channels.

3. To change the Input mode of the Sub-screen.
  - Make sure that the speaker icon is located next to the Input mode indication of the Sub-screen (lower).
  - Press **Input Select** buttons on the remote control. (AV1~5 are available)

4. To change the location of the Sub-screen.
  - Press  buttons. The Sub-screen will move up and down.

5. To exit from the Multi Picture mode, press  button.

#### NOTE

- In case that the Input signal for the Sub-screen is either 1080i/50 or 1080i/60 Component signal, select "Movie" in "Frequency mode". (See "Setup Menu" on [26](#) for details)
- When operating Multi Picture mode, the "Power Save mode" is not available even though the Horizontal/Vertical Sync. Signal (or any kind of Video signal) has not input for certain period of time.
- To prevent the image retention of the screen, do not leave the unit with operating Multi Picture mode for long hours.

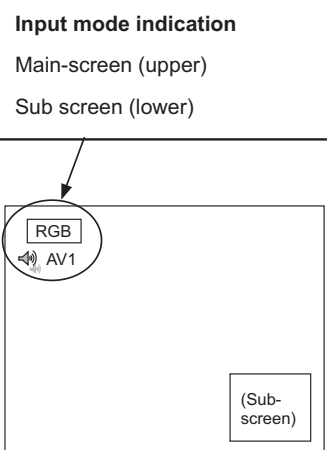

## FUNCTION (continued)

### Picture Freezing

This is the useful function utilizing the characteristics of freezing picture effectively. By pressing  button, you can change to freeze mode easily anytime you like. Press it again to return to normal picture.

FREEZE button



ENGLISH

There are two types of freeze mode as usage. These are possible to select at the "Freeze Mode" from Function Menu. **(27)**

#### Split:

It displays 2 pictures from the same source. One is active (left), while the other is still picture (right). This is very useful in order to avoid missing or take note necessary information, such as ingredients in cooking.

[Split]



#### Strobe:

It displays 12 pictures from the same source. 11 of them are still, while the last picture is active. This can be used to check such movement as swinging of golf club and baseball bat.

[Strobe]

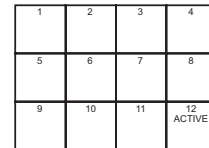



This function is also available in AV input mode besides TV mode. Refer to the table as shown in "Recommended Signal List" on **(60)**.

## FUNCTION (continued)

### Photo Input Function

With this Photo Input function, you can enjoy watching Photos from such devices as Digital Still Camera and SD card on monitor along with useful features such as Slide Show with Background Music and Movie picture.

#### Operating the Photo Input

1. Before operating this function, make sure to turn the power OFF /Standby.
2. Prepare the DSC (Digital Still Camera) / USB card reader/ SD card or MMC as follows.
  - Digital Still Camera : Set up with reference to the content about "connecting to PC" in the user manual of DSC.
  - USB Card Reader : Insert only one memory card.
  - SD Card / MMC : Ensure the card is inserted in the correct direction as indicated near the slot.
3. Connect the USB cable to the input terminal as shown (Right side), or insert the SD card /MMC into the slot (Left side).
4. Turn ON the TV after the USB cable is connected or the SD card / MMC is inserted.
5. Press  button on the remote control to activate Photo Input mode.  
(Then, turn ON the DSC. Refer to the user manual of your DSC for the timing.)
6. Each time  button is pressed, you can switch the mode as follows.

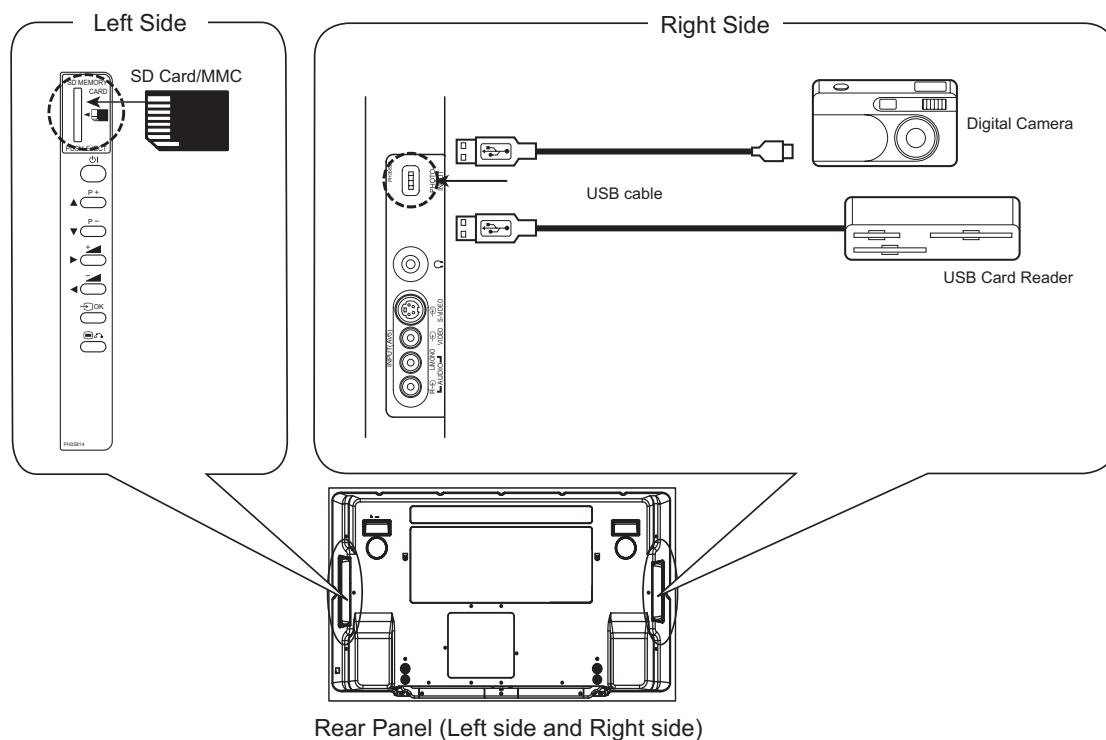
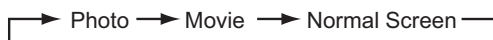

#### NOTE

- Do not insert SD Card/MMC and USB cable at the same time.
- Do not insert anything other than SD Card/MMC into the slot. It could cause malfunction or damage to the slot. Do not allow children to play around the slot.

## FUNCTION (continued)

### Photo Input Function (continued)

#### Displaying Still Picture in Photo Mode

#### Thumbnail-Size Image (Index) to Full-Size Image

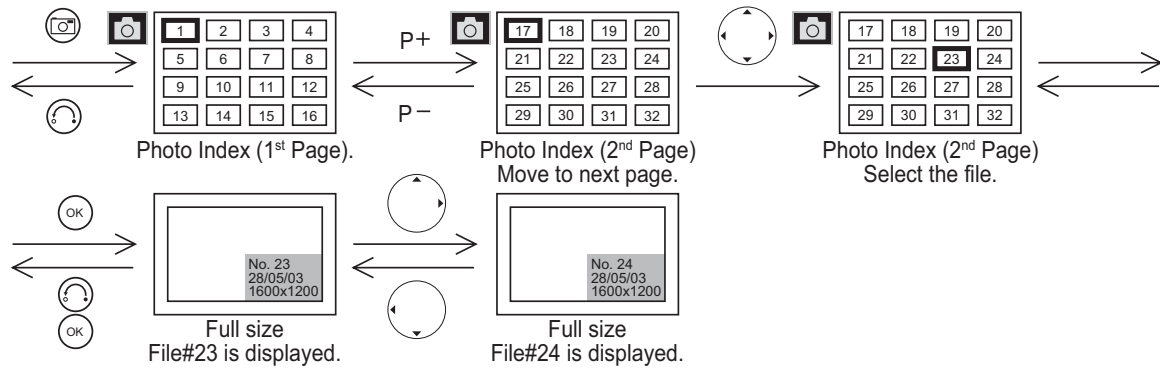

- When you enter the Photo Index mode, the icon appears as the indication.
- You can also select the preferred file in both Thumbnail-size and Full-size image by inputting the file directly with numeric buttons of remote control.

#### Rotation Function

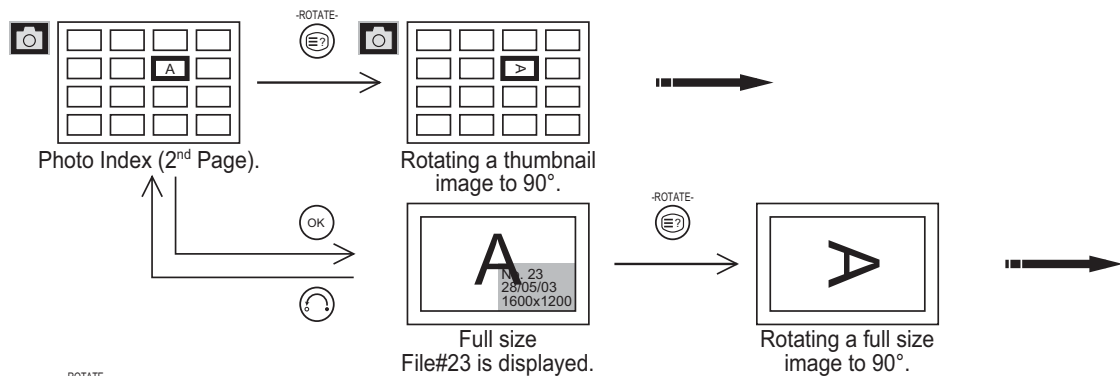

- Each time button is pressed, the picture is rotated in the sequence of the following.

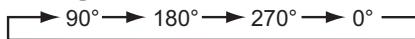



## FUNCTION (continued)

### Photo Input Function (continued)

#### Displaying Still Picture in Photo Mode (continued)

##### Slide Show Function

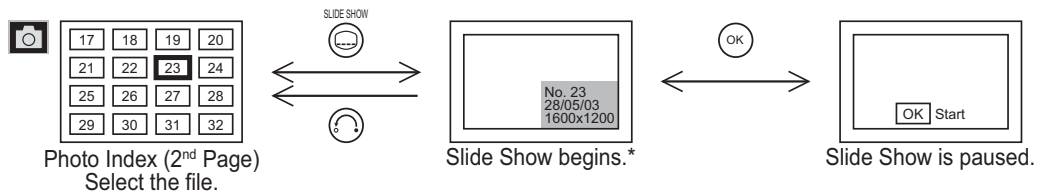

\*You can select where to start Slide Show. See "Slide Mode" in the table 1.

\*You can also start the slide show when displaying the selected full size image, press SLIDE SHOW button by pressing  button.

- If the pause is left for more than a minute, the slide show restarts automatically.
- If you stop the slide show halfway, the photo index page selects the file in which you stopped.
- You can make specific adjustment on "**Slide Effect / Slide Interval / Slide Music / Slide Mode**" from "Function Menu (2<sup>nd</sup> page)". While operating Photo Input function, you can jump to there by pressing  button. Press it again to return to the Photo Input page. (Refer to Table 1 as below.)

#### NOTE

Contrast will decrease automatically to reduce Image Retention if stationary images such as still photos are left on the screen for more than 3 minutes. Please note that it is not malfunction.

• Table 1. Slide Show Adjustment

Function Menu	Selection	Description
<b>Slide Effect</b>	Off→1→2	Select Slide Switching Method. Off: No effect 1: Fade In/Out effect 2: Wipe effect
<b>Slide Interval</b>	5Sec.→10Sec.→30Sec.	Select preferred interval times.
<b>Slide Music</b>	Off→1→2	Select the Background Music. Off: No sound. 1: Slow tempo music. 2: Up tempo music.
<b>Slide Mode</b>	1→2	Select starting point of slide show. 1: Start from the selected file. 2: Start from 1 <sup>st</sup> file.

# FUNCTION (continued)

## Photo Input Function (continued)

### Displaying Movie Picture in Movie Mode

#### Thumbnail-Size Image (Index) to Full-Size Image:

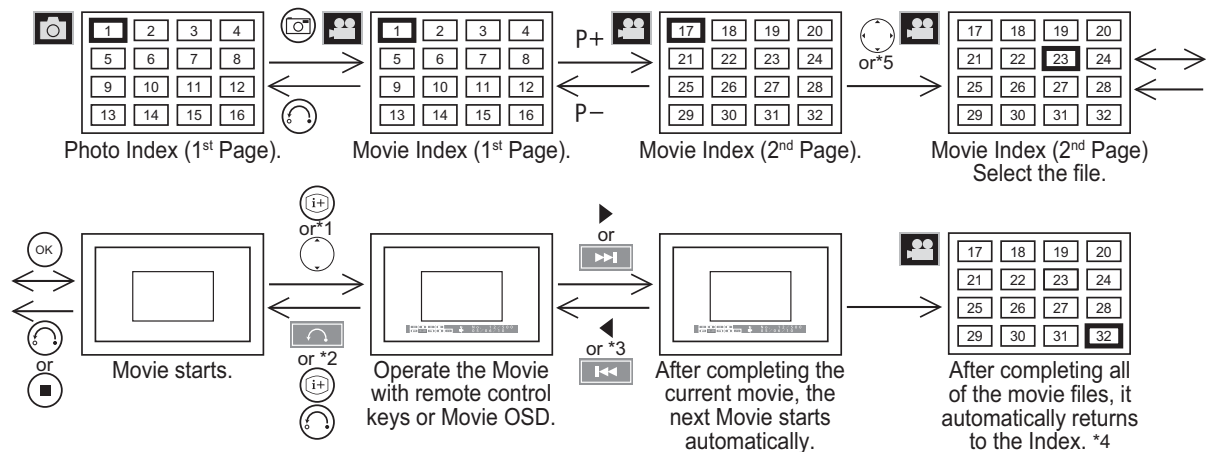

- \*1: Press ▲▼ or (i+) button to display the operation OSD.
- \*2: Press (i+) button in remote control or [ ] button (OSD) to exit from the OSD display.
- \*3: For the Previous button on remote control or OSD, pressing it once starts over the current movie. By pressing it again within 2 seconds after that, you can return to the previous movie.
- \*4: When it moves on the unsupported file, it automatically returns to the Index.
- \*5: You can also select the Thumbnail-Size image by inputting file # with numeric buttons of remote control.

#### [Operating the Movie]

• You can use the following control key to operate the movie.

	Play	Stop	Fast-forward	Rewind	Pause	Next	Previous <sup>*3</sup>	Zoom	Slow Play	Exit
Remote Control	AV4	AV3	RGB	HDMI2	HDMI1					
OSD										

• The movie OSD contains the file information and control keys as below.



• The following indications might appear in Movie Operation OSD.

- : The movie does not have sound, or this function does not support only the sound of movie.
- : This function does not support the movie.

• With (i+) button on the remote control, you can switch the size of movie display between normal and double in full size mode.

#### NOTE

- In case of displaying movie pictures,
  - 1) If your DSC supports SD card/MMC, insert the card to the monitor directly rather than USB.
  - 2) If your DSC is PictBridge-compatible and has a function to switch between PTP and Mass Storage connection, change your setting to Mass Storage and then connect to Photo Input terminal so that it can be available on both Still and Movie pictures. PTP connection can display still pictures but not movie pictures.
  - 3) If your DSC does not support SD card / MMC or Mass Storage connection, use USB card reader to connect with Photo Input terminal. Please note that we do not guarantee all DSC can make either or both Mass Storage and USB card reader connection.
- Comparing to movie pictures through SD card/MMC, the movie pictures using USB might have lower performance such as dropping frames.



## FUNCTION (continued)

### Photo Input Function (continued)

#### Other

- You can select the background pattern on "Background" from "Function Menu."

Function Menu	Selection	Description
Background	1→2	Select preferred background pattern. 1: Striped texture of gray 2: Green checked pattern

- Press  button whenever you want to return from full size image to index.
- The file information is displayed by pressing  button.



Thumbnail-Size Image





Full-Size Image (Still)



Full-Size Image (Movie)\*

\* The size of the image depends on the resolution for the image.

#### To exit from Photo Input...

You can exit from Photo Input when...  
Pressing  button in Photo Index mode, or  
Pressing  button in Movie mode (Index and full).

#### OSD Information

Operation	Message
Accessing	"Loading..." *
Loading Files	"Loading..." *
Normal	no message
Not insert USB/SD/MMC	"! No Connection"
Not available format	"! No Connection"
Abnormal	"! No Connection"
No File	"! No File"

\*The message "Loading..." starts to blink automatically if it is displayed on the screen more than 5 seconds.

#### Specification

Application	① Digital Still Camera corresponding to DCF standard. ② USB Card Reader with the memory containing pictures had taken by ① camera. ③ SD card/MMC card containing picture had taken by ① camera.	
Photo	Max number of photo file	500
	Max number of pixel	8176 x 8176(DCF JPEG format)
Movie	Max number of movie file	500
	Supported Video Format (Extension/Max number of pixel)	Motion JPEG (avi.mov/640*480)
		MPEG1 (mpg/640*480)
		MPEG4 (avi,mov,mp4,asf/352*288)
	Supported Audio Format	PCM (Incompressible format)
		ADPCM
		G.726
μ-LAW PCM		
	MPEG1-LayerII	

## FUNCTION (continued)

### Photo Input Function (continued)

#### CAUTION

- The picture may not be displayed on this monitor in case of copying, viewing or editing by computers, etc.
- Do not connect any apparatus other than DSC, USB card reader, and SD card/MMC to the Photo Input connector. It causes the malfunction.
- Do not connect a DSC and USB card reader with USB HUB. Pictures may not be displayed correctly, or it causes the malfunction.
- Insert only one memory even though the USB card reader has multiple slots for memory card. Pictures in multiple memories cannot be seen at the same time.
- Certain types of DSC, card readers, or SD card/MMC may not work with this Photo Input function.
- DSC with low battery power may not properly display photos in this function.
- Response time might vary depending on each image contents when switching pages, loading files, and playing each movie.
- Contrast will decrease automatically if stationary images such as still photos are left on the screen for more than 3 minutes.
- The OSD message “! No Connection” is displayed in case of the incomplete connection with USB cable or SD card / MMC and connection to a digital still camera or USB card reader without the memory card.
- The menu items other than “Picture,” “Function,” and “Audio” are not available with grayed-out display.
- The functions of the multi picture, CH selection, freeze mode, aspect, mode display, and so on are not available.
- During blinking LED which indicates the access of DSC / USB card reader /SD card/ MMC, or displaying “Loading...”, do not turn the power off/standby mode nor remove/insert USB cable and memory card.
- The picture may not be displayed correctly, depending on the connecting device in case of extending the USB cable.
- PictBridge-compatible DSC can be connected to Photo Input terminal through PTP transfer, which supports still pictures but not movie pictures. Refer to the DSC user manual for PictBridge in details.
- Do not use this function other than private purposes. It might infringe copyright laws.
- Back up all of the data in the memory card in case if data was lost due to unexpected accident. We do not assume any liability for the losses by misuse or malfunction.

## FUNCTION (continued)

### Audio Switching

#### NICAM / Sound Multiplex(including A2) (TV mode)

You can make optimum use of available audio by pressing  bottom of remote control. Audio can be switched only if receiving NICAM and sound multiplex signals; otherwise, pressing this button will have no effect, such as when only mono sound is received.

These can be divided into two main categories: Bilingual/Dual Sound broadcast and Stereo broadcast.

#### Bilingual/Dual Sound broadcast

Bilingual broadcast is the broadcast available on the main and sub languages, while dual sound broadcast is available on the primary and secondary sounds; for example, some sports programs contain broadcast commentary on a game as primary sound, and a commentary about a team as the secondary.

When bilingual program is received, sound mode display appears in yellow as shown. Also, when receiving NICAM signals, NICAM display will appear.

Each time  button is pressed, the display is switched in the sequence of following.

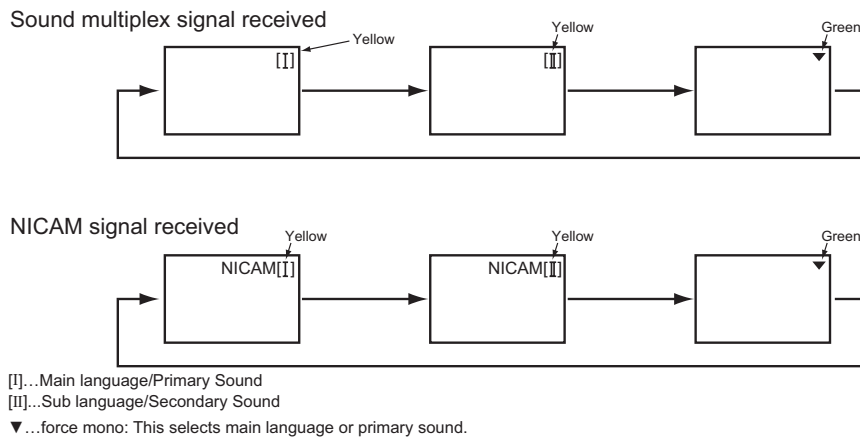

#### Stereo broadcast

With stereo broadcast, you can enjoy different sound from either side.

When a stereo program is received, sound mode display will appear in red as shown. Also, when receiving NICAM signals, NICAM display will appear.

Press  button to switch between stereo and mono sound.

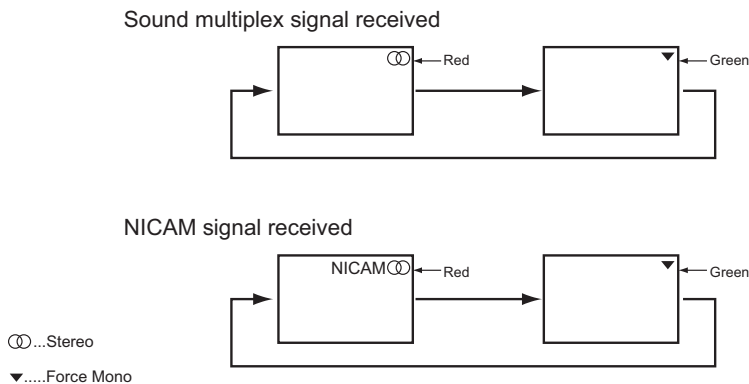

#### NOTE

- Please select ▼ (force mono) in case of poor reception, noise, poor stereo sound due to signal condition so that you can receive a clear mono sound.
-  represents the Mono broadcast.

## FUNCTION (continued)

### Power Save Mode

#### When AV input is selected

- You are provided the function to save power consumption when no signal is detected in AV input. Set to On in "Video Power Save" from Function Menu, which leads to the power save mode in AV1 /AV2 /HDMI1 /HDMI2 and the Standby mode in other AV input. (Please see the table below for details) Refer to [27](#) about "Video Power Save".

	When no signal is detected		When signal is input during On in "Video Power Save"
	Condition	Indicating Lamp	
AV1, AV2, HDMI1, HDMI2	Power Save	Orange	Turns On automatically.
AV3~AV5	Standby	Red	Remains as Standby mode.

#### When the RGB input is selected

- When this unit is connected to a VESA DPMS computer, the Power Save mode (Operation mode : Off) can be set to be activated automatically when the computer is not being used to reduce power consumption by this unit.

RGB sync signal	Horizontal	Yes	No	Yes	No
	Vertical	Yes	Yes	No	No
<b>PC signal</b>	Active (normal display)		Blank (no display)		
<b>Operation mode</b>	On		Off		
<b>Indicating lamp</b>	Lights green		Lights orange		

#### Returning to operating status

- Operate the personal computer, or press either the INPUT SELECT button of the control panel or the RGB button of the remote control.

## FUNCTION (continued)

### DVD Player / STB Selection

You can use this remote control to operate DVD Player and Set Top Box of other makers as well as this set. After pressing (SEL) button, press (or hold) the required buttons to select the maker and type as shown below.

#### Set up hint

Example: HITACHI DVD②

1. Set up the maker.  
Press (SEL) button to indicate the DVD LED on the remote control. While the DVD LED is blinking (Approx. 30 Seconds), press (SEL) and ① buttons.
2. Set up the maker type.  
Release the ① button while keeping (SEL) button depressed. Then press ② button.
3. Confirm the setting.  
After setting the maker and type, press the SUB POWER button on the remote control. If the DVD does not switch ON, repeat step 1 and 2 using other maker types as listed.



#### <<“DVD” Selection>>

Makers of DVD Player	Set Maker	Set type	Makers of DVD Player	Set Maker	Set type
HITACHI	(SEL) ①	①~③	RCA	(SEL) ⑩	(SEL) ①
FUNAI	(SEL) ②	①	Mitsubishi	(SEL) (SEL)	(SEL) ①
Pioneer	(SEL) ③	①~⑥	ONKYO	(SEL) RED	(SEL) ①~③
Panasonic	(SEL) ④	①~④	ZENITH	(SEL) GREEN	(SEL) ①
TOSHIBA	(SEL) ⑤	①~④	THOMSON	(SEL) YELLOW	(SEL) ①
Philips	(SEL) ⑥	①~②	SHINCO	(SEL) BLUE	(SEL) ①
JVC	(SEL) ⑦	①	SKYWORTH	(SEL) (SEL)	(SEL) ①
SAMSUNG	(SEL) ⑧	①	BUBUKO	(SEL) (SEL)	(SEL) ①
Sony	(SEL) ⑨	①~④	DENON	(SEL) (SEL)	(SEL) ①~②
Sharp	(SEL) (SEL) 2-4-12	①~②	YAMAHA	(SEL) (SEL)	(SEL) ①~②

#### <<“SAT” Selection>>

Makers of STB Player	Set Maker	Set type
HITACHI	(SEL) ①	(SEL) ①~②
TOSHIBA	(SEL) ②	(SEL) ①
DGTEC	(SEL) ③	(SEL) ①
Panasonic	(SEL) ④	(SEL) ①



#### NOTE

Please note that not all models of the listed makers can be operated using this remote control.





## TROUBLESHOOTING

Before calling service technician, check the following tables first. If the problem is not be solved with the suggested procedures, contact your local dealer. For your safety, NEVER try to repair the product by yourself.

### When Following Messages Appear on the Screen

Message	Condition / Action	Page
<b>Power Save</b>	This indicates it is in Power Save mode. (in AV/RGB mode) The indicating lamp lights in orange.	<a href="#">27</a> , <a href="#">52</a>
<b>No Sync. Signal</b>	The unit cannot detect any signals from any input terminals. <ul style="list-style-type: none"> <li>• Check if the cable is connected correctly and firmly.</li> <li>• Check if the power of the external equipments is ON.</li> <li>• Check if the input selection matches the connection terminal.</li> <li>• Check if the PC is in Power Save mode or not.</li> </ul>	<a href="#">14</a> ~ <a href="#">16</a>
<b>Invalid Scan Freq.</b>	The unit receives signals not supported by the monitor. <ul style="list-style-type: none"> <li>• Check if the cable is connected correctly and firmly.</li> <li>• Check if the input signal is compatible with the specification of the monitor.</li> </ul>	<a href="#">57</a> , <a href="#">59</a>
<b>Not Available</b>	This shows when the selected operation is not available.	
<b>Please Push [Return] button</b>	This message appears when you select other than  button while Screen Wipe is ON. Press  button when this message appears.	<a href="#">27</a>
<b>Check Antenna</b>	Check the connection status when this message appears.	<a href="#">13</a>
<b>Auto Adjusting</b>	This indicates that it is in the process of auto adjusting. (in RGB mode)	<a href="#">25</a>

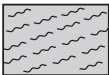

### Symptom and Check List

Symptoms		Check list	Page
No picture - no sound		<ul style="list-style-type: none"> <li>• Check the Indicating lamp status (Off, Red, Green, or Orange).</li> <li>• Check the connection of the Power Cord and/or other cables.</li> <li>• Check if the Main Power of the unit or external equipments is ON.</li> <li>• Check if the TV mode is selected.</li> <li>• Check if the TV is in "Standby mode" or "Power Save mode".</li> <li>• Adjust the values in "Picture menu" and "Audio menu".</li> </ul>	<a href="#">13</a> ~ <a href="#">16</a> <a href="#">18</a> , <a href="#">23</a> , <a href="#">52</a>
Snowy picture-poor sound		<ul style="list-style-type: none"> <li>• Check the antenna connection and direction.</li> <li>• The TV station may have broadcast difficulties. Try another channel.</li> </ul>	<a href="#">13</a>
Multiple images-normal sound		<ul style="list-style-type: none"> <li>• Check the antenna connection and direction.</li> <li>• Fine tuning the TV.</li> <li>• Check the connection of the external equipments.</li> <li>• The TV station may have broadcast difficulties. Try another channel.</li> </ul>	<a href="#">13</a> , <a href="#">22</a>
Intermittent interference		<ul style="list-style-type: none"> <li>• Check if the source of interference is shielded well.</li> <li>• Remove those kinds of electrical devices away from the TV.</li> </ul>	
Normal picture, but no sound		<ul style="list-style-type: none"> <li>• Check the volume level.</li> <li>• Check if the  button has been pressed or not.</li> <li>• Make sure that the headphone is NOT connected.</li> <li>• Check the connection of the external equipments.</li> </ul>	<a href="#">19</a>
No picture - normal sound		<ul style="list-style-type: none"> <li>• Check the value level of "Brightness" and "Contrast" in "Picture Menu".</li> </ul>	<a href="#">29</a> , <a href="#">32</a>
The remote control does not work.		<ul style="list-style-type: none"> <li>• Check if the batteries are installed correctly.</li> <li>• The batteries might be exhausted. Replace them with new ones.</li> <li>• Remove all the obstructions in front of the sensor window on the unit.</li> <li>• Check if you select the correct function by  button on the remote control.</li> <li>• Check if the buttons of the control panel can work.</li> </ul>	<a href="#">10</a> , <a href="#">11</a>
Normal picture but no color-normal sound		<ul style="list-style-type: none"> <li>• Check the connection of the external equipments.</li> <li>• Check the "Color System" in "Setup Menu".</li> </ul>	<a href="#">14</a> ~ <a href="#">16</a>









## TROUBLESHOOTING (continued)

### Symptom and Check List (continued)

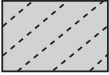
Symptoms	Check list	Page
<ul style="list-style-type: none"> <li>No picture The Indicating lamp → Off</li> </ul>	<ul style="list-style-type: none"> <li>Check if the Power Cord is plugged into the socket firmly.</li> <li>Check if the Main Power is ON.</li> </ul>	17, 18
<ul style="list-style-type: none"> <li>No picture The Indicating lamp → Orange It means that the unit is in "Power Save mode".</li> </ul>	<ul style="list-style-type: none"> <li>Check if all the cables of the external equipments are connected correctly and firmly.</li> <li>Check if the power of the external equipments is ON.</li> <li>Check if the TV/AV mode has been selected correctly.</li> <li>Check if the PC is in Power Save mode or not.</li> <li>Refer to "Power Save mode" and "When following messages appears on the screen".</li> </ul>	52
<ul style="list-style-type: none"> <li>No picture The indicating lamp → Green</li> </ul>	<ul style="list-style-type: none"> <li>Check if the signal cable is connected correctly and firmly.</li> <li>Adjust the level of Brightness and Contrast lower.</li> </ul>	14 ~ 16
<ul style="list-style-type: none"> <li>The top of the monitor and surface of the panel heat up.</li> </ul>	<ul style="list-style-type: none"> <li>It may happen when you use the unit for long hours. Turn off the Main Power of the unit for a while. Please note that this is not malfunction.</li> </ul>	57, 59
<ul style="list-style-type: none"> <li>Image cannot be displayed in the correct position.</li> </ul>	<ul style="list-style-type: none"> <li>Press  button to check if the input signal of the displayed image is compatible with the specification of the monitor.</li> </ul>	25, 57, 59
<ul style="list-style-type: none"> <li>When the VCR is in special playback features (Fast Forward or Rewind), the screen gets dark and cannot see the image at all.</li> </ul>	<ul style="list-style-type: none"> <li>It could happen when the VCR is connected to Component output, such as 480i. This is not malfunction.</li> <li>Try Composite output or S-video output and check the picture again.</li> </ul>	
<ul style="list-style-type: none"> <li>The images are not displayed on sub pictures in "Multi Picture mode"</li> </ul>	<ul style="list-style-type: none"> <li>There are some combinations of input signals that the images are not displayed on sub pictures. Please check the Table of "2-Picture" and "4-picture/2-picture(1080i)" for details.</li> </ul>	41 ~ 43 60
<ul style="list-style-type: none"> <li>Screen display size cannot be switched correctly.</li> </ul>	<ul style="list-style-type: none"> <li>The display size is fixed at "FULL" when the receiving signals are 1080i/60Hz, 1080i/50Hz, 720p/60Hz, or 720p/50Hz.</li> <li>Check the signal status by pressing the  button on the remote control.</li> </ul>	38, 39
<ul style="list-style-type: none"> <li>Cannot be displayed the image from HDMI 1 or 2.</li> </ul>	<ul style="list-style-type: none"> <li>Check if the cables are connected correctly.</li> <li>Check the output format of the equipments.</li> <li>(Please refer to "Connecting Procedure" and "Recommended Signal List".)</li> </ul>	57 ~ 59

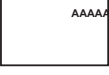
# TROUBLESHOOTING (continued)

## Symptom and Check List (continued)

Symptoms		Check list	Page
<ul style="list-style-type: none"> <li>Cannot display the image from "Photo Input function".</li> </ul>		<ul style="list-style-type: none"> <li>Check the connecting equipments and image format. (Please refer to "Photo Input function".)</li> </ul>	<p><b>45</b>, <b>49</b>, <b>50</b></p>
<ul style="list-style-type: none"> <li>The image on the screen is moving in an oblique direction. (PC input mode only)</li> </ul>		<ul style="list-style-type: none"> <li>Adjust "Horizontal Clock" and "Clock Phase".</li> </ul>	<b>25</b>
<ul style="list-style-type: none"> <li>The coarse horizontal stripes could be seen in full-display mode. (PC input mode only)</li> </ul>		<ul style="list-style-type: none"> <li>Adjust "Horizontal Clock".</li> </ul>	<b>25</b>
<ul style="list-style-type: none"> <li>The part of the image is lacking. (PC input mode only)</li> </ul>		<ul style="list-style-type: none"> <li>Check if the "Screen Saver" is OFF.</li> <li>Try "Auto Adjust".</li> <li>Check if it is in Full2. Set to Full1.</li> </ul>	<b>25</b> , <b>27</b> , <b>38</b> , <b>39</b>
<ul style="list-style-type: none"> <li>The horizontal stripes are moving vertically with flickering screen. (PC input mode only)</li> </ul>		<ul style="list-style-type: none"> <li>Check the Signal status of the PC by pressing (i+) button on the remote control.</li> <li>If the Vertical Frequency of the PC is set to less than 85Hz, adjust its level higher (up to 85Hz).</li> <li>Set "Vertical Filter" to ON. (Please note that you will have lower vertical resolution with this action.)</li> </ul>	<b>26</b>
<ul style="list-style-type: none"> <li>When the characters are displayed on the whole screen, <u>the vertical stripes appear and some of the characters are blurred.</u> (PC input mode only)</li> </ul>		<ul style="list-style-type: none"> <li>Try "Auto Adjust".</li> <li>If the display condition is not improved with Auto Adjust, adjust "Horizontal Clock".</li> </ul>	<b>25</b>
<ul style="list-style-type: none"> <li>When the letter string is displayed in full-screen, <u>all of the characters</u> on the screen are blurred. (PC input mode only)</li> </ul>		<ul style="list-style-type: none"> <li>Try "Auto Adjust".</li> <li>If the condition is not improved with Auto Adjust, adjust "Clock Phase" till you get clearest image.</li> </ul>	<b>25</b>
<ul style="list-style-type: none"> <li>When the small patterns are displayed on the screen, the entire screen is flickering. (PC input mode only)</li> </ul>		<ul style="list-style-type: none"> <li>Try "Auto Adjust".</li> <li>If the condition is not improved with Auto Adjust, adjust "Clock Phase" till you get flicker-free display.</li> </ul>	<b>25</b>
<ul style="list-style-type: none"> <li>The thickness of the letters, lines, etc is <u>not</u> displayed evenly. (PC input mode only)</li> </ul>		<ul style="list-style-type: none"> <li>It could happen when the image with more than 540 lines of vertical resolution is displayed. Please note this is not malfunction.</li> </ul>	<b>59</b>

## PRODUCT SPECIFICATIONS

SPECIFICATION		
Panel	Display dimensions	Approx. 42 inches (922 (H) x 522 (V) mm, diagonal 1059mm)
	Resolution	1024(H) x 1080 (V) pixels
Net dimensions		including Optional Stand: 1134(W)x728(H)x350(D) mm excluding Optional Stand: 1134(W)x648(H)x98(D) mm
Net weight		including Optional Stand: 43.4kg excluding Optional Stand: 37.7kg
Ambient conditions	Temperature	Operating : 5°C to 35°C, Storage : 0°C to 40°C
	Relative humidity	Operating : 20% to 80%, Storage : 20% to 90% (non-condensing)
Power supply		AC100 - 240V, 50/60Hz
Power consumption/ at standby		370W / <3W
Audio output		speaker total 36W
(VIDEO input)		
Input terminals		AV1•2: composite video input terminal (RCA) component video input terminal (RCA) L/R audio input terminal (RCA) AV3•5: composite video input terminal (RCA) S video input terminal. L/R audio input terminal (RCA) AV4 : composite video input terminal (RCA) L/R audio input terminal (RCA) HDMI 1•2 : HDMI input terminal Audio input terminal (3.5mm Stereo Mini Jack) Photo Input : Photo Input terminal / SD card slot
Input signals		Composite video: PAL, SECAM, NTSC3.58, NTSC4.43, PAL60 Component video: 480i, 576i, 480p, 576p, 720p/50, 720p/60, 1080i/50, 1080i/60
Output Signal		OUTPUT (MONITOR): composite video monitor-output terminal (RCA) OUTPUT (MONITOR): L/R audio monitor- output terminal (RCA) OUTPUT (HEADPHONE): L/R audio monitor- output terminal (Mini-pin) OUTPUT (SUB-WOOFER): Woofer output terminal
(RF input)		
Input terminal / Receiving range		ANT : 75Ω Unbalanced / 44~870MHz
RF Video System		PAL B, G, H / I / D, K SECAM B, G / D, K / K1 NTSC-M
(RGB input)		
Input terminals		Analog RGB input terminal (D-sub 15-pin) Audio input terminal (3.5mm Stereo Mini Jack)
Input signals		0.7 V/1.0 Vp-p, analog RGB (Recommended Signal)
Sync signals		H/V separate, TTL level [2KΩ] H/V composite, TTL level [2KΩ] Sync on green, 0.3 Vp-p [75Ω]

- The monitor takes at least 30 minutes to attain the status of optimal picture quality.

## PRODUCT SPECIFICATIONS (continued)

### Signal Input

#### RGB terminal (D-sub 15-pin connector)

Pin	Input signal
1	R
2	G or sync on green
3	B
4	No connection
5	No connection
6	R.GND
7	G.GND
8	B.GND
9	No connection
10	GND
11	No connection
12	[SDA]
13	H. sync or H/V composite sync
14	V.sync. [V.CLK]
15	[SCL]

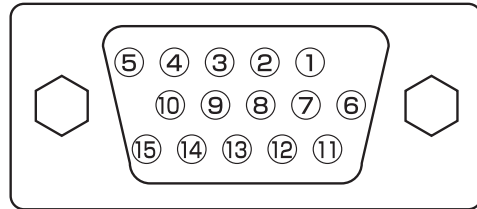

- When different kinds of input signals are simultaneously input to the monitor via a graphics board or the like, the monitor will automatically select the signals in the following priority order:

Sync signal type	Priority
H/V separate sync.	1
H/V composite sync.	2
sync.on Green *	3

- \* Even in the case of the recommended signals shown on the following page, there may be instances when correct display is not possible. In this case, use H/V separate sync, H/V composite sync.

#### S-input connector pin specifications

Pin	Input signal
1	Y
2	Y-GND
3	C
4	C-GND
Frame	GND

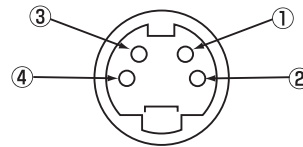

#### Photo-input connector pin specifications

Pin	Input signal
1	5V
2	DM
3	DP
4	GND

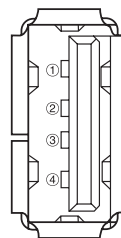

#### HDMI connector pin specifications

Pin	Input signal	Pin	Input signal
1	TMDS Data2+	11	TMDS Clock Shield
2	TMDS Data2 Shield	12	TMDS Clock-
3	TMDS Data2-	13	CEC
4	TMDS Data 1+	14	Reserved(N.C. on device)
5	TMDS Data1 Shield	15	SCL
6	TMDS Data1-	16	SDA
7	TMDS Data0+	17	DDC/CED Ground
8	TMDS Data0 Shield	18	+5V Power
9	TMDS Data0-	19	Hot Plug Detect
10	TMDS Clock+		

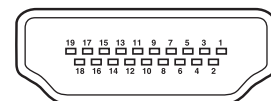

## PRODUCT SPECIFICATIONS (continued)

### Recommended Signal List

#### With HDMI input

No.	Signal mode			Horizontal frequency (kHz)	Dot clock frequency (MHz)	Remarks
	Signal Name	Resolution	Vertical frequency (Hz)			
1	VGA	640 X 480	59.94	31.47	25.18	EIA-861B
2	576i	720(1440) X 576	50.00	15.63	27.00	EIA-861B
3	480i	720(1440) X 480	59.94	15.73	27.00	EIA-861B
4	576p	720 X 576	50.00	31.25	27.00	EIA-861B
5	480p	720 X 480	59.94	31.47	27.00	EIA-861B
6	1080i/50	1920 X 1080	50.00	28.13	74.25	EIA-861B
7	1080i/60	1920 X 1080	60.00	33.75	74.25	EIA-861B
8	720p/50	1280 X 720	50.00	37.50	74.25	EIA-861B
9	720p/60	1280 X 720	60.00	45.00	74.25	EIA-861B

#### With RGB input

No.	Signal mode			Horizontal frequency (kHz)	Dot clock frequency (MHz)	Remarks
	Signal Name	Resolution	Vertical frequency (Hz)			
1	VGA	640 X 400	70.08	31.47	25.18	
2		640 X 480	59.94	31.47	25.18	
3	W-VGA	864 X 480	59.94	31.47	34.24	WVGA type : On
4	VESA	640 X 480	72.81	37.86	31.50	
5		640 X 480	75.00	37.50	31.50	
6		640 X 480	85.01	43.27	36.00	
7		800 X 600	56.25	35.16	36.00	
8		800 X 600	60.32	37.88	40.00	
9		800 X 600	72.19	48.08	50.00	
10		800 X 600	75.00	46.88	49.50	
11		800 X 600	85.06	53.67	56.25	
12		1024 X 768	60.00	48.36	65.00	
13		1024 X 768	70.07	56.48	75.00	
14		1024 X 768	75.03	60.02	78.75	
15		1024 X 768	85.00	68.68	94.50	
16		1152 X 864	75.00	67.50	108.00	
17		1280 X 1024	60.02	63.98	108.00	
18		1280 X 1024	75.03	79.98	135.00	
19		1280 X 1024	85.02	91.15	157.50	
20		1600 X 1200	60.00	75.00	162.00	
21		1600 X 1200	75.00	93.75	202.50	
22	1600 X 1200	85.00	106.25	229.50		
23	Macintosh	640 X 480	66.67	35.00	30.24	
24		832 X 624	74.55	49.72	57.28	
25		1024 X 768	74.93	60.24	80.00	
26		1152 X 870	75.06	68.68	100.00	
27	W-XGA	1280 X 768	59.833	47.986	81.00	
28		1280 X 768	69.997	56.137	94.760	
29	W-XGA	1280 X 768	59.876	47.776	79.50	WXGA Mode : 1280x768
30		1366 X 768	60.015	47.712	85.50	WXGA Mode : 1366x768

- The type of video board or connecting cable used may not allow for correct displays adjustment of Horizontal Position, Vertical Position, Horizontal Clock and Clock Phase.
- The monitor may fail to display an animation image correctly when a signal having a vertical frequency of 85Hz or higher is input to it.
- The monitor differentiates the signal modes according to the horizontal and vertical frequencies and the horizontal and vertical sync signal polarities. Note that different signals having all these elements alike may be handled as the same signal.
- Displaying images with more than 540 lines of vertical resolution at Full display (compressed display) can result in the interpolation of stripes.

## PRODUCT SPECIFICATION (continued)

### Recommended Signal List (continued)

ENGLISH

#### With Multi Picture Function

##### • 2-Picture / (1080i)\*

Input terminal	Sub Main	TV	AV1~AV5			AV1, AV2				TELE TEXT
			PAL SECAM	NTSC3.58 NTSC4.43	576i 576p	480i 480p	720p/50 720p/60	1080i/50 1080i/60		
	TV	○	○	○	○	○	○	○	○	○
AV1 ~AV5	PAL, SECAM	○	○	○	○	○	○	○	○	
	NTSC3.58/4.43	○	○	○	○	○	○	○	○	
AV1 AV2	576i, 576p	○	○	○	○	○	○	○	○	
	480i, 480p	○	○	○	○	○	○	○	○	
	720p/50, 60	○	○	○	○	○	○	○	○	
	1080i/50, 60*	○	○	○	○	○	○	○	○	

(○ : Available)

##### • 4-Picture

Input terminal	Sub Main	TV	AV1~AV5			AV1, AV2				TELE TEXT
			PAL SECAM	NTSC3.58 NTSC4.43	576i 576p	480i 480p	720p/50 720p/60	1080i/50 1080i/60		
	TV	○	○	○						
AV1 ~AV5	PAL, SECAM	○	○	○						
	NTSC3.58/4.43	○	○	○						
AV1 AV2	576i, 576p	○	○	○						
	480i, 480p	○	○	○						
	1080i/50, 60	○	○	○						
	720p/50, 60	○	○	○						

(○ : Available)

#### With Picture Freezing Function

	Split	Strobe
TV	○	○
PAL, SECAM	○	○
NTSC3.58/4.43	○	○
576i	○	○
480i	○	○
576p	○	
480p	○	
720p/50, 60	○	
1080i/50, 60	○	
HDMI		
RGB		

(○ : Available)