

# HITACHI

## PLASMA TELEVISION

AVC (Audio Video Control Center) & Plasma Display Monitor

### 32HDX60

### 42HDX60

### 50HDX60

## OPERATING GUIDE



**IMPORTANT SAFETY INSTRUCTIONS** 2-3



**FIRST TIME USE** 4-23

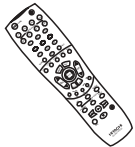

**THE REMOTE CONTROL** 24-41



**ON-SCREEN DISPLAY** 42-66



**USING THE RGB INPUT OF THE PLASMA TV** 67-76



**USEFUL INFORMATION INDEX** 77-85



# IMPORTANT SAFETY INSTRUCTIONS

## SAFETY POINTS YOU SHOULD KNOW ABOUT YOUR HITACHI PLASMA TELEVISION

Our reputation has been built on the quality, performance, and ease of service of HITACHI Plasma Televisions.

Safety is also foremost in our minds in the design of these units. To help you operate these products properly, this section illustrates safety tips which will be of benefit to you. Please read it carefully and apply the knowledge you obtain from it to the proper operation of your HITACHI Plasma Television.

Please fill out your warranty card and mail it to HITACHI. This will enable HITACHI to notify you promptly in the improbable event that a safety problem should be discovered in your product model.

Follow all warnings and instructions marked on this plasma television. Plasma television consists of AVC center and display monitor.

	<p><b>CAUTION</b></p> <p>RISK OF ELECTRIC SHOCK DO NOT OPEN</p>			<p>The lightning flash with arrowhead symbol, within an equilateral triangle, is intended to alert the user to the presence of uninsulated "dangerous voltage" within the product's enclosure that may be of a sufficient magnitude to constitute a risk of electric shock to persons.</p>
<p>CAUTION: TO REDUCE THE RISK OF ELECTRIC SHOCK, DO NOT REMOVE COVER (OR BACK). NO USER SERVICEABLE PARTS INSIDE. REFER SERVICING TO QUALIFIED SERVICE PERSONNEL.</p>				<p>The exclamation point within an equilateral triangle, is intended to alert the user to the presence of important operating and maintenance (servicing) instructions in the literature accompanying the appliance.</p>

**WARNING:**

- TO PREVENT FIRE OR SHOCK HAZARD, DO NOT EXPOSE THIS PLASMA TELEVISION TO RAIN OR MOISTURE.
- THE PLASMA TELEVISION SHOULD NOT BE EXPOSED TO DRIPPING OR SPLASHING AND OBJECTS FILLED WITH LIQUIDS, SUCH AS VASES, SHOULD NOT BE PLACED ON THE TELEVISION.

**NOTE:**

- There are no user serviceable parts inside the AVC center/display monitor.
- Model and serial numbers are indicated on back side of the AVC center/display monitor.

**CAUTION:** Adjust only those controls that are covered in the instructions, as improper changes or modifications not expressly approved by HITACHI could void the user's authority to operate the Plasma Television.



**MODIFICATIONS:** The FCC requires the user to be notified that any changes or modifications made to this device that are not expressly approved by Hitachi America, Ltd. Home Electronics Division may void the user's authority to operate the equipment.

**POWER SOURCE**

**THIS PLASMA TELEVISION IS DESIGNED TO OPERATE ON 120 VOLTS 60Hz, AC CURRENT. INSERT THE AVC CENTER AND DISPLAY MONITOR POWER CORD INTO A 120 VOLT 60Hz OUTLET.**

**TO PREVENT ELECTRIC SHOCK, DO NOT USE THE PLASMA TELEVISION'S (POLARIZED) PLUG WITH AN EXTENSION CORD, RECEPTACLE, OR OTHER OUTLET UNLESS THE BLADES AND GROUND TERMINAL CAN BE FULLY INSERTED TO PREVENT BLADE EXPOSURE.**

**NEVER CONNECT THE AVC CENTER/DISPLAY MONITOR TO 50Hz, DIRECT CURRENT, OR ANYTHING OTHER THAN THE SPECIFIED VOLTAGE.**

**NOTE:** This Plasma Television will display television closed captioning, ( or ) , in accordance with paragraph 15.119 of the FCC rules.

 **CAUTION:** Never remove the back cover of the AVC center/display monitor as this can expose you to very high voltages and other hazards. If the television does not operate properly, unplug the Plasma Television and call your authorized dealer or service center.

# IMPORTANT SAFETY INSTRUCTIONS



## Read before operating equipment

Follow all warnings and instructions marked on this television.

1. Read these instructions.
2. Keep these instructions.
3. Heed all warnings.
4. Follow all instructions.
5. Do not use this apparatus near water.
6. Clean only with a dry cloth.
7. Do not block any ventilation openings. Install in accordance with the manufacturer's instructions.
8. Do not install near any heat sources such as radiators, heat registers, stoves, or other apparatus (including amplifiers) that produce heat.
9. Do not defeat the safety purpose of the polarized or grounding-type plug. A polarized plug has two blades with one wider than the other. A grounding type plug has two blades and a third grounding prong. The wide blade or the third prong are provided for your safety. If the provided plug does not fit into your outlet, consult an electrician for replacement of the obsolete outlet.
10. Protect the power cord from being walked on or pinched particularly at plugs, convenience receptacles, and the point where they exit from the apparatus.
11. Only use the attachments/accessories specified by the manufacturer.
12.  Use only with the cart, stand, tripod, bracket, or table specified by the manufacturer, or sold with the apparatus. When a cart is used, use caution when moving the cart/apparatus combination to avoid injury from tip-over.
13. Unplug this apparatus during lightning storms or when unused for long periods of time.
14. Refer all servicing to qualified service personnel. Servicing is required when the apparatus has been damaged in any way, such as power-supply cord or plug is damaged, liquid has been spilled or objects have fallen into apparatus, the apparatus has been exposed to rain or moisture, does not operate normally, or has been dropped.

15. Televisions are designed to comply with the recommended safety standards for tilt and stability. Do not apply excessive pulling force to the front, or top, of the cabinet which could cause the product to overturn resulting in product damage and/or personal injury.
16. Follow instructions for wall, shelf or ceiling mounting as recommended by the manufacturer.
17. An outdoor antenna should not be located in the vicinity of overhead power lines or other electrical circuits.
18. If an outside antenna is connected to the receiver be sure the antenna system is grounded so as to provide some protection against voltage surges and built up static charges. Section 810 of the National Electric Code, ANSI/NFPA No. 70-1984, provides information with respect to proper grounding for the mast and supporting structure, grounding of the lead-in wire to an antenna discharge unit, size of grounding connectors, location of antenna-discharge unit, connection to grounding electrodes and requirements for the grounding electrode.

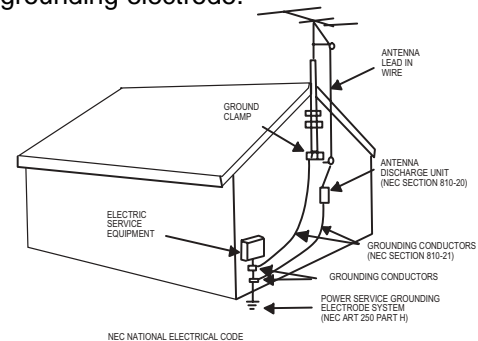

Note to the CATV system installer: This reminder is provided to call the CATV system installer's attention to Article 820-40 of the NEC that provides guidelines for proper grounding and, in particular, specifies that the cable ground shall be connected to the grounding system of the building, as close to the point of cable entry as practical.

**This product contains lead. Dispose of this product in accordance with applicable environmental laws. For product recycling and disposal information, contact your local government agency or the Electronic Industries Alliance at [www.eiae.org](http://www.eiae.org) (in the US) or the Electronic Product Stewardship Canada at [www.epsc.ca](http://www.epsc.ca) (in Canada). For more information, call "1-800-HITACHI."**

**Do not place any objects on the top of the television which may fall or cause a child to climb to retrieve the objects.**

## **PREVENTION OF SCREEN BURN**

Continuous on-screen displays such as video games, stock market quotations, computer generated graphics, and other fixed (non-moving) patterns can cause permanent damage to television receivers. Such "SCREEN BURNS" constitute misuse and are **NOT COVERED** by your HITACHI Factory Warranty.

## **PUBLIC VIEWING OF COPYRIGHTED MATERIAL**

Public viewing of programs broadcast by TV stations and cable companies, as well as programs from other sources, may require prior authorization from the broadcaster or owner of the video program material.



# ACCESSORIES

Check to make sure you have the following accessories before disposing of the packing material.

FIRST TIME USE

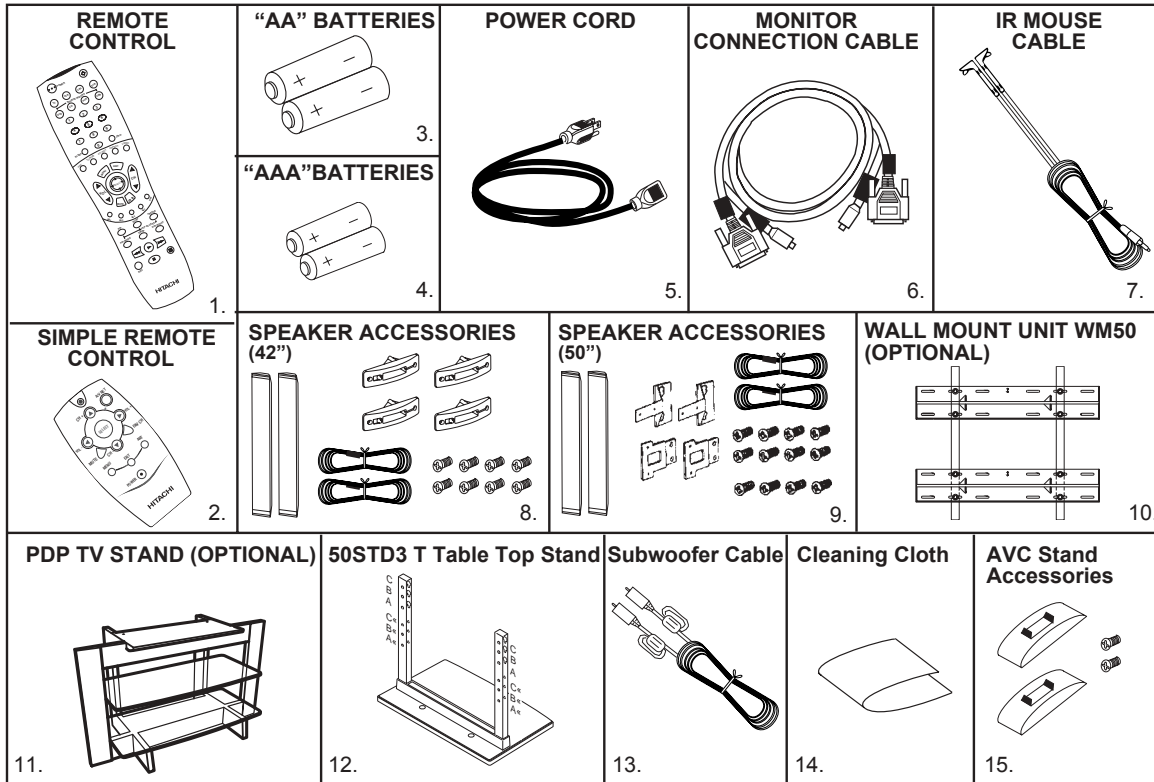

- CAUTION:**
- The plasma display wall mount unit WM50 is for use only with Hitachi model 32HDX60, 42HDX60 and 50HDX60.
  - Ceiling mounting is not recommended. Mounting the panel on the ceiling does not provide adequate ventilation for the electronics or proper support for the front glass panel. This plasma television product is designed for a maximum tilting angle of 45 degrees from vertical.
  - This SPD321 PDP stand for use only with Hitachi 32HDX60. Use with other apparatus is capable of resulting in instability causing possible injury.
  - This SPD421 PDP stand for use only with Hitachi 42HDX60 Use with other apparatus is capable of resulting in instability causing possible injury.
  - This 50STD3 T stand for use only with Hitachi 50HDX60. Use with other apparatus is capable of resulting in instability causing possible injury. See important marking located on bottom of stand.

- Remote Control Unit CLU-5726TSI (P# HL01826).
- Simple Remote Control Unit CLU-120S (P#HL01861).
- Two "AA" size, 1.5V batteries (P# FQ00021).
- Two "AAA" size, 1.5V batteries (P# FR00061).
- Power Cord:
 

	32"/42"	50"
Plasma Monitor	EV01841	EV01861
AVC	EV01841	EV01841
- Monitor Connection Cable (P#EW07883).
- Two IR Mouse cables (P# EY01641).
- Speaker Accessories (42" only) (P#GM01196).
- Speaker Accessories (50" only) (P#GM01234).
- Wall Mount Unit WM50 (Optional) (P#QX00563).
- 32" Stand (SPD321 P# H520443) (Optional).  
42" Stand (SPD421 P# H520444) (Optional).
- 50" Table Top Stand (50STD3 T) (P#QD35633).
- Sub Woofer Cable (P# VZ11701).
- Cleaning Cloth (P#MS00803).
- AVC Stand Accessories (P#QJ01081).

## REMOTE CONTROL BATTERY INSTALLATION AND REPLACEMENT

- Open the battery cover of the remote control by pushing the notched part of the cover with your fingers and pulling the cover off.
- Insert two new "AA" and "AAA" size batteries for the remote control and simple remote control respectively. When replacing old batteries, push them towards the springs and lift them out.
- Match the batteries to the (+) and (-) marks in the battery compartment.
- Replace the cover.

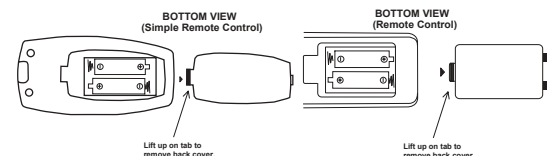

**CAUTION:** Danger of explosion if battery is incorrectly replaced. Replace with the same or equivalent type.

# HOW TO SETUP YOUR NEW HITACHI PLASMA TELEVISION



## SPEAKER INSTALLATION 42"

1. Screw the speaker holder to the speakers as shown below.

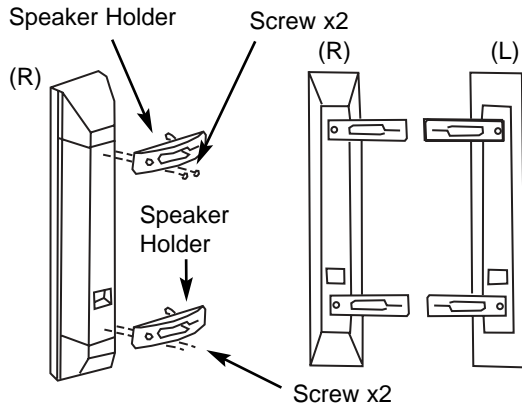

2. Loosen 4 screws (A) (two on the left and two on the right).
3. Completely unscrew 4 screws (B) (two on the left and two on the right).
4. Hook the speaker holders to the loosened screws (A).
5. Screw the speaker holders to the Display Monitor with screws (B).
6. Tighten screws (A).

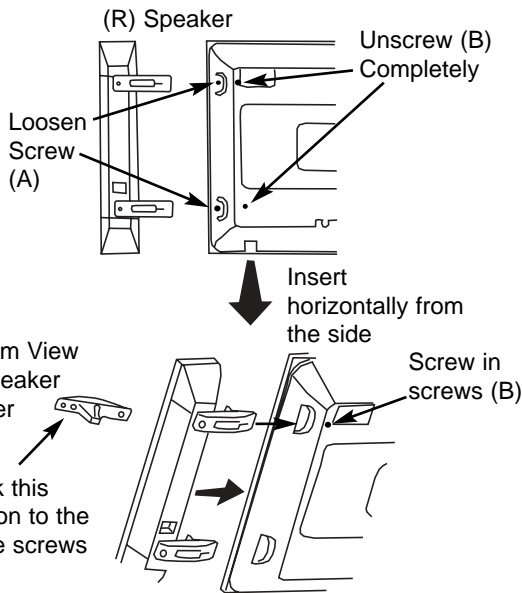

7. Connect the speaker wires as shown below, make sure the core is toward the display monitor side.

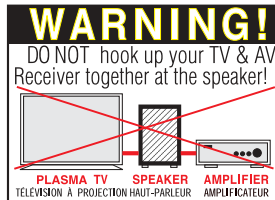
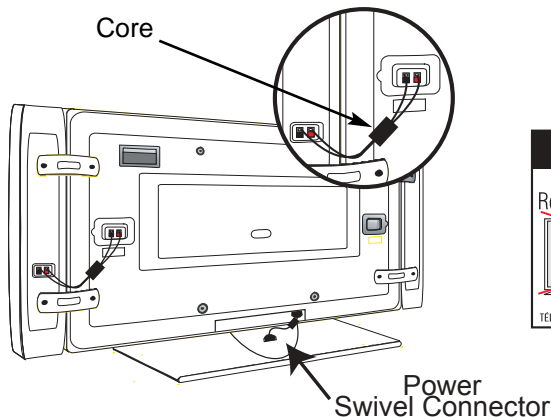

## SPEAKER INSTALLATION 50"

1. Screw the speaker holder to the speakers as shown below.

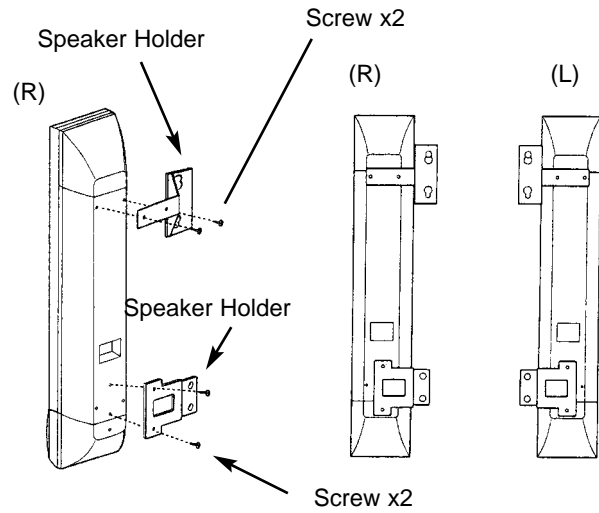

2. Screw in screw (C).
3. Hook the upper speaker holder to the screw in (C).
4. Screw in the lower speaker holder (D).
5. Tighten screws (C) and (D).

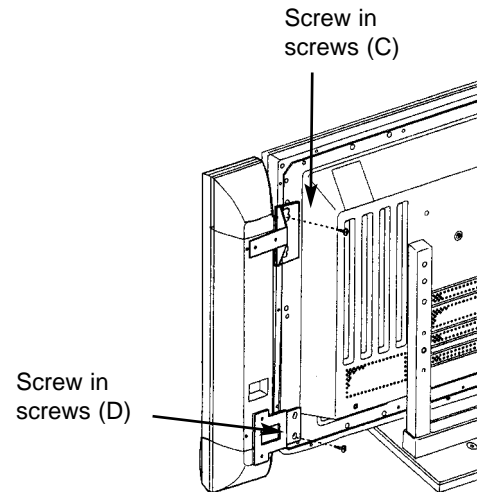

6. Connect the speaker wires as shown below, make sure the core is toward the display monitor side.

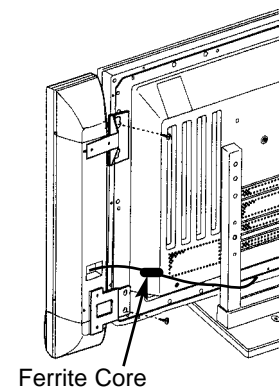

**NOTES:** Do not connect speakers simultaneously to the speaker terminal of the Plasma TV and an external amplifier.



# HOW TO SETUP YOUR NEW HITACHI PLASMA TELEVISION

FIRST TIME USE

To take measures to prevent the Plasma Display from tipping over and prevent possible injury it is important to mount the unit in a stable place.

## Securing to a table-top

1. Using wood screws (two) fasten the set to the clamping screw holes on the rear of the Plasma Display stand as shown below.
2. Using commercially available wood screws, secure the set firmly in position.

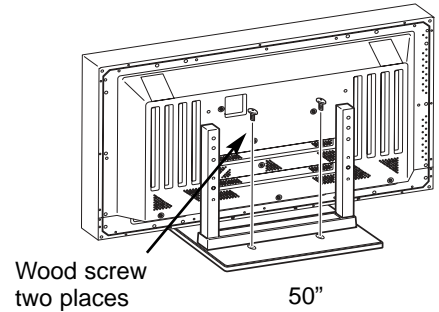
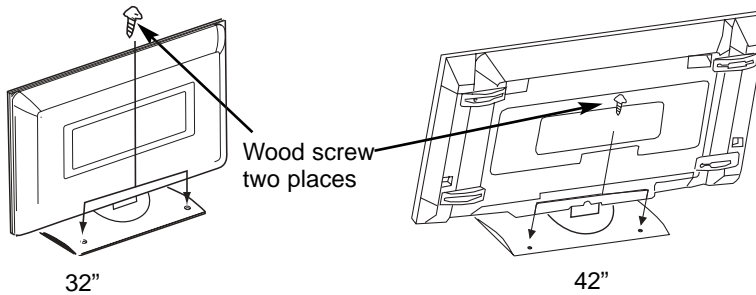

## Securing to a wall

1. Keep the Plasma Display monitor four inches away from the wall except those hung to the wall mount bracket.
2. Secure the monitor to the wall as shown below.

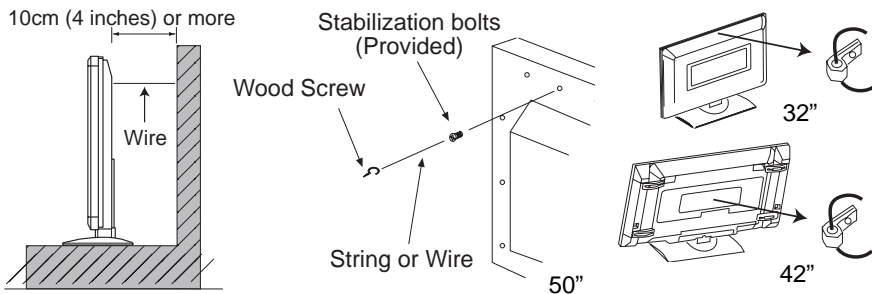

## AVC Vertical Position (Using AVC Stand)

1. Install AVC Stand with screws provided.
2. AVC ventilation holes should be facing out.

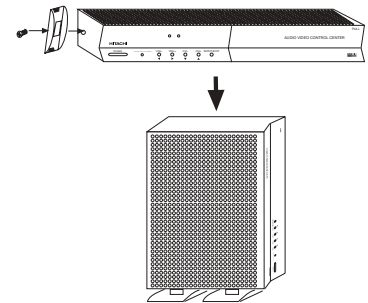

- NOTES:**
1. Do not block the ventilation holes of the Plasma Display monitor or the AVC center. Blocking the ventilation holes might cause fire or defect.
  2. The plasma television has two AC cords, one on the AVC center and the other on the Plasma Display monitor. In case of an abnormal symptom, unplug both AC cords.
  3. If you purchased the wall mount bracket option, please ask for professional installer. Do not install by yourself.

## Caution when moving the main unit

As this product is heavy, whenever it is moved, two people are required to transport it safely. Whenever the unit is moved it should be lifted forward using the two handgrips at the back for the 42", and at the top and base on both sides of the 32" and 50" for stability. When moving the Display Monitor, lift the handles and the bottom frame as shown below. Do not grab the speakers or the back cover when lifting.

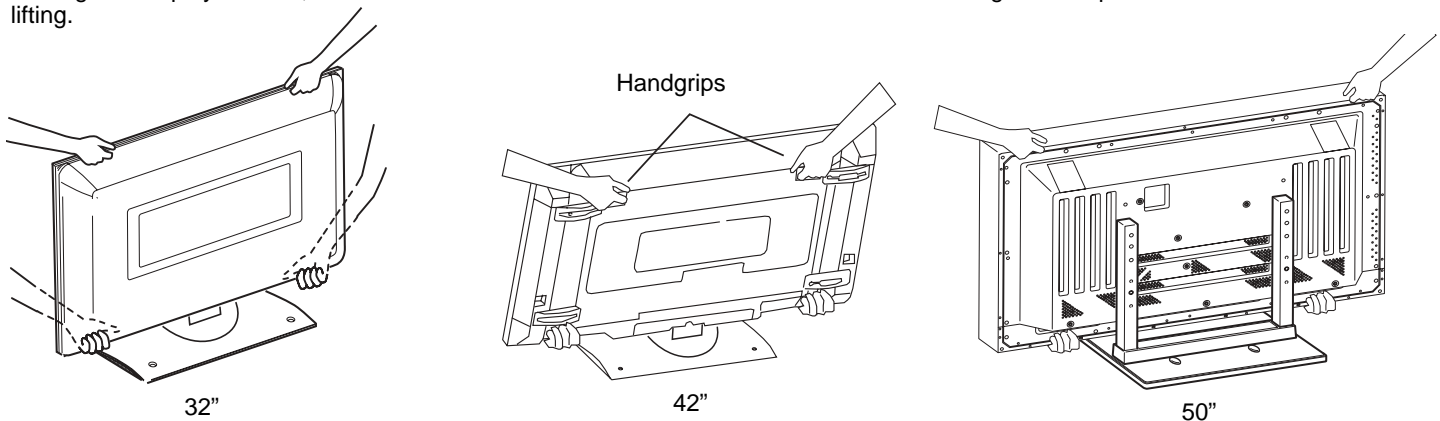

## ANTENNA

Unless your Plasma Television is connected to a cable TV system or to a centralized antenna system, a good outdoor color TV antenna is recommended for best performance. However, if you are located in an exceptionally good signal area that is free from interference and multiple image ghosts, an indoor antenna may be sufficient.

## LOCATION

Select an area where sunlight or bright indoor illumination will not fall directly on the picture screen. Also, be sure that the location selected allows a free flow of air to and from the perforated back cover of the set.

To avoid cabinet warping, cabinet color changes, and increased chance of set failure, do not place the TV where temperatures can become excessively hot, for example, in direct sunlight or near a heating appliance, etc.



# HOW TO SET UP YOUR NEW HITACHI PLASMA TELEVISION



## VIEWING

The major benefit of the HITACHI Plasma Television is its large viewing screen. To see this large screen at its best, test various locations in the room to find the optimum spot for viewing. The best picture is seen by sitting directly in front of the TV and about 8 to 18 feet from the screen.

During daylight hours, reflections from outside light may appear on the screen. If so, drapes or screens can be used to reduce the reflection or the TV can be located in a different section of the room.

If the TV's audio output will be connected to a Hi-Fi system's external speakers, the best audio performance will be obtained by placing the speakers equidistant from each side of the receiver cabinet and as close as possible to the height of the picture screen center. For best stereo separation, place the external speakers at least four feet from the side of the TV, place the surround speakers to the side or behind the viewing area. Differences in room sizes and acoustical environments will require some experimentation with speaker placement for best performance.

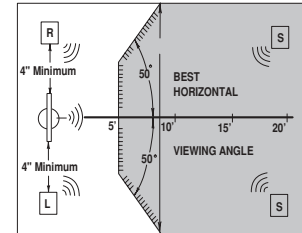
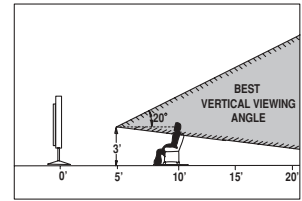

## IMPORTANT NOTES

No.	Items	Notes
1	Arching sound from plasma display monitor's panel.	A buzzing sound might be heard when the plasma display monitor is turned on in a very quiet room. This is due to the plasma panel drive circuit when it is functioning. This arching sound is normal and it is not a malfunction.
2	Interference for infrared equipment.	Some infrared rays are emitted from the plasma display monitor's panel that might affect other infrared controlling equipment.
3	Bright and dark spots	High-precision technology is used to manufacture the plasma display panel; But in some cases, there are minor defects in some parts of the screen. Points that do not light, points with brightness different from that of the periphery, points with color different from that of the periphery, etc. Some pixels will always be on or always off. Please note that this is not a malfunction.
4	Picture Image (Spectrum)	When receiving still picture signals, (e.g. channel number indication or clock indication) for a while, you can see image-like when the picture varied. This is not a defect.
5	Display panel surface temperature is too high	The plasma display panel is lighting the phosphors by the discharge of internal radiation. In some cases, this may cause the temperature of the panel surface to increase. Please note that this is not a malfunction. The Plasma TV surface temperature is higher than a Cathode-ray-tube.
6	Plasma Surface	The plasma panel is made from glass. Heavy shock on the front panel might damage it.
7	Transportation	When the PDP monitor is transported horizontally, the glass panel has the possibility of being broken or increasing the picture defects. At the time of transportation, horizontal style is prohibited. More-over, please treat the plasma panel with great care because of a precision apparatus. Please instruct transporters so that it should be put into the packing box at the time of shipment (there is a possibility that breakage of the panel or defects will increase). Rough transportation might cause damage to the panel and pixel failure.
8	Image retention	The plasma monitor illuminates phosphor to display images. The phosphor has a finite illumination life. After extended periods of illumination, the brightness of the phosphor will be degraded to such extent that stationary images would burn-in that part of the screen as grayed-out images. For 50" only, brightness will decrease automatically during still and slightly moving pictures. This is not a failure. This is a special feature to avoid image retention. Tips to prevent such image retention are: - Do not display images having sharp brightness differences or hi-contrast images, such as monochrome characters and graphic patterns, for long. - Do not leave stationary images appearing for long, but try to refresh them at appropriate intervals of time, or try to move them using screen saver function. - Turn down the contrast and brightness controls.
9	Luminosity and contrast	PDP television has luminosity and low contrast compared with CRT television.
10	Granular spots	When a screen is seen at point-blank range, a random fine grain may be visible to a dark part.
11	Disturbance to video apparatus	If an apparatus (VCR, etc.) antenna line is arranged near the monitor, the image may shake, or disturbance may be received.
12	Lip Sync	There is some time lag between the picture and the sound. You can see lip motion that is delayed compared to the sound.
13	About the use environment of PDP television (temperature)	Electric discharge/luminescence characteristic of the PDP panel also changes with peripheral temperature. Moreover, since there is also high power consumption value, a specified temperature environment is required.
14	Caution on prolonged storage	Storing the plasma television for a period of more than 2 to 3 months without use might cause an unstable picture when the set is turned on.
15	Operating	Operating altitude: 800 to 1,114hPa (6,194ft to -2,484ft). Operating temperature: 41°F to 95°F.
16	Storage	Storage Altitude: 300 to 1114hPa (31,912ft to -2,484ft). Storage temperature: 5°F to 140°F.
17	Power ON or OFF	Frequent use of the Power ON or OFF might trigger the power protection circuit. If the TV does not turn ON, please wait a little before turning ON again.



# HOOKUP CABLES

FIRST TIME USE

Most video/audio connections between components can be made with shielded video and audio cables that have phono connectors. For best performance, video cables should use 75-Ohm coaxial shielded wire. Cables can be purchased from most stores that sell audio/video products. Below are illustrations and names of common connectors. Before purchasing any cables, be sure of the output and input connector types required by the various components and the length of each cable.

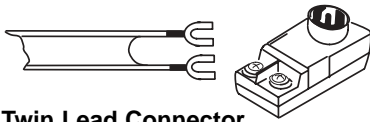

### 300-Ohm Twin Lead Connector

This outdoor antenna cable must be connected to an antenna adapter (300-Ohm to 75-Ohm).



### Phono Connector

Used on all standard video and audio cables which connect to inputs and outputs located on the rear jack panel and front control panel.

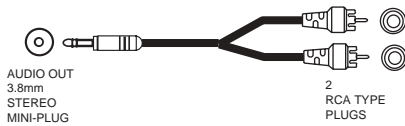

### Stereo Cable (3.5 mm plug to 3.5 mm plug)

This cable is used to connect from external audio out to the audio input of the AVC Center (ex. RGB Input).

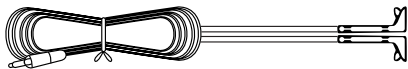

### IR Mouse Cable (Provided)

Connect the IR Mouse to the IR output on your AVC center when A/V Network is used. You must place the IR mouse in front of the corresponding IR window of your cable box and VCR. This connection allows your TV to control your cable box and VCR.

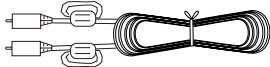

### Subwoofer Cable (Provided)

This cable is used to connect an external audio component input to the subwoofer output of the Display Monitor.



### "F" Type 75-Ohm Coaxial Antenna Connector

For connecting RF signals (antenna or cable TV) to the antenna jack on the television.



### S-Video (Super Video) Connector

This connector is used on camcorders, VCRs and laser-disc players with an S-Video feature in place of the standard video cable to produce a high quality picture.

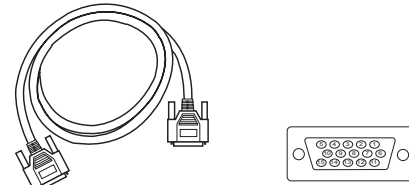

### D-SUB MINI 15-Pin Cable

This cable is used to connect a computer output to the D-SUB input located on the rear panel of the AVC Center. The resolution should be set correctly to display the signal on the Plasma Television.

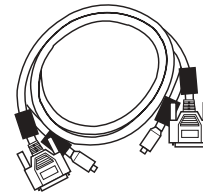

### Monitor Connection Cable (Provided)

This cable is used to connect the Display Monitor to the AVC Center.

## ANTENNA CONNECTIONS TO REAR JACK PANEL

### VHF (75-Ohm) antenna/CATV (Cable TV)

When using a 75-Ohm coaxial cable system, connect the outdoor antenna or CATV coaxial cable to the ANT A (75-Ohm) terminal. If you have a second antenna or cable TV system, connect the coaxial cable to the ANT B terminal.

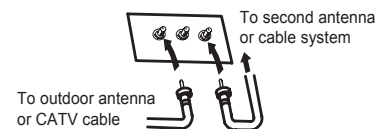

### VHF (300-Ohm) antenna/UHF antenna

When using a 300-Ohm twin lead from an outdoor antenna, connect the VHF or UHF antenna leads to screws of the VHF or UHF adapter. Plug the adapter into the antenna terminal on the TV.



### When both VHF and UHF antennas are connected

Attach an optional antenna cable mixer to the TV antenna terminal, and connect the cables to the antenna mixer. Consult your dealer or service store for the antenna mixer.

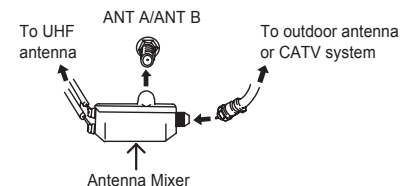



# FRONT PANEL CONTROLS



## FRONT VIEW

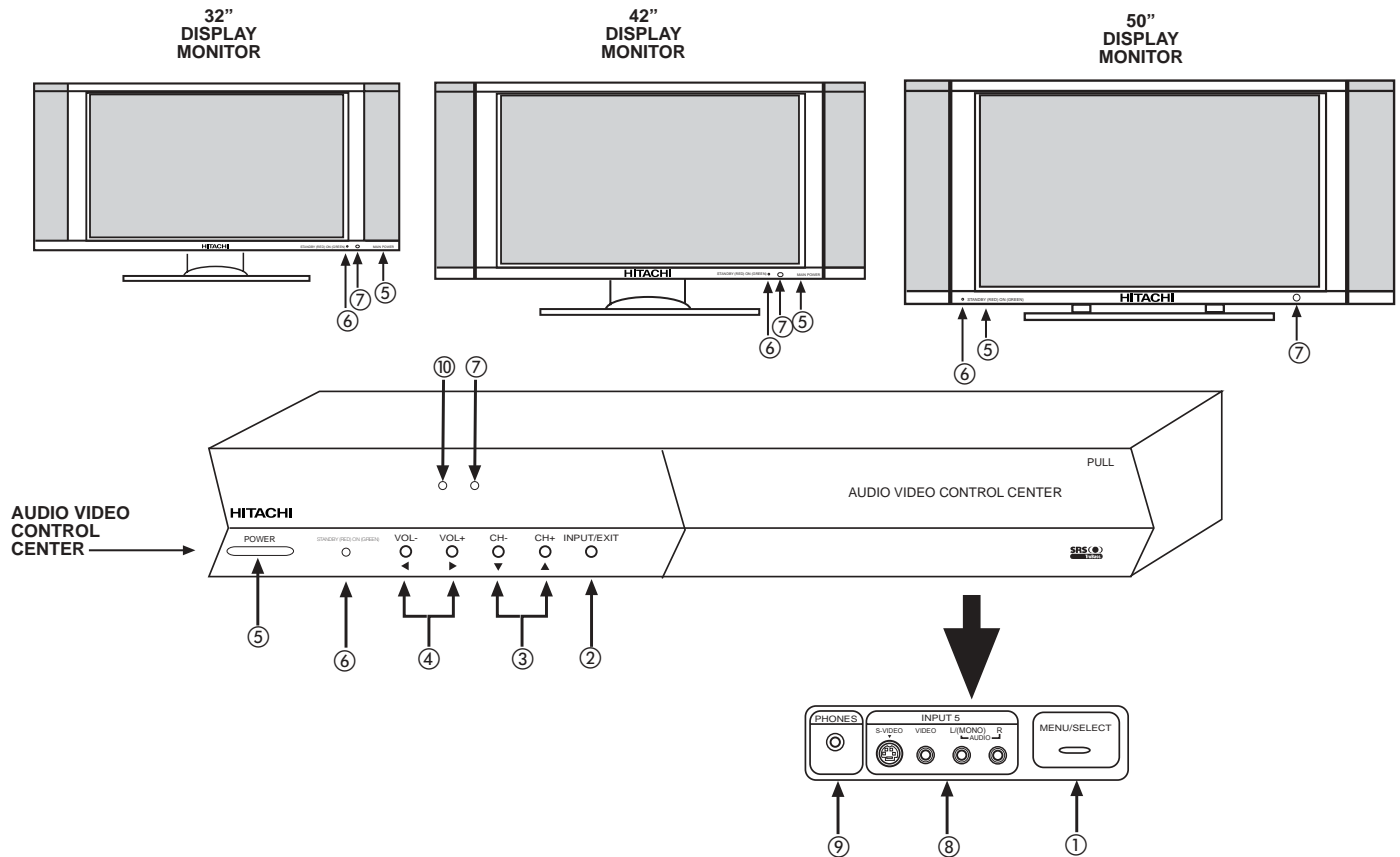

FIRST TIME USE

### ① MENU/SELECT button

This button allows you to enter the MENU, making it possible to set TV features to your preference without using the remote. This button also serves as the SELECT button when in MENU mode.

### ② INPUT/EXIT button

Press this button to select the desired input, VIDEO 1 to 5, RGB, or Ant A/B source. Your selection is shown in the top right corner of the screen. This button also serves as the EXIT button when in MENU mode.

**NOTES:** Your remote control does not have an INPUT button. To change to video inputs, press VID1~VID5 buttons depending on the input you wish to switch to (see page 31). Press TV/RGB button on the remote control to toggle between TV and RGB (ANALOG INPUT).

### ③ CHANNEL selector

Press these buttons until the desired channel appears in the top right corner of the TV screen. These buttons also serve as the cursor down (▼) and up (▲) buttons when in MENU mode.

### ④ VOLUME level

Press these buttons to adjust the sound level. The volume level will be displayed on the TV screen. These buttons also serve as the cursor left (◀) and right (▶) buttons when in MENU mode.



# FRONT PANEL CONTROLS

FIRST TIME USE

## ⑤ POWER button

### Display Monitor "MAIN POWER" button

This power button is for the complete system, and must be turned ON/OFF manually. It is recommended to leave the "MAIN POWER" to ON condition (lights red) for stand-by mode.

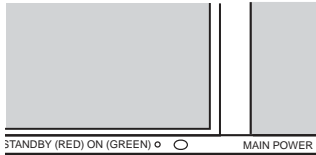

32"/42"

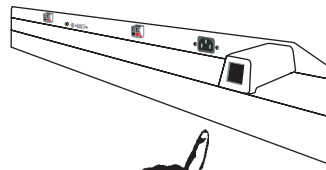

or

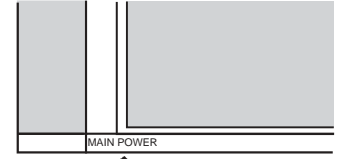

50"



## AVC POWER button

The AVC power can be turned ON/OFF manually or by remote control. Turning on the AVC Power will only turn on the AVC box if the "MAIN POWER" of the display monitor is off.

## ⑥ POWER light indicator

To turn the monitor ON, press the main power switch located on the lower right side of the monitor (lower left for 50"). A red stand-by indicator lamp located on the lower right corner of the front bezel will illuminate (lower left for 50"). The PDP is now ready for remote on/off operation.

Indicating Lamp	Power Status	Operating
Off	Off	When the main power switch is set OFF.
Lights Red	Off (Stand-by)	When the main power switch on the display monitor is ON, and the AVC Center is OFF.
Lights Green	On	Display monitor MAIN POWER is ON and AVC Center power is ON.
Lights Orange (Flashing)	Off (Power Saving)	Display monitor MAIN POWER is ON and AVC Center power is ON, with no signal input except antenna (no sync. signal).

## ⑦ REMOTE CONTROL sensor

Point your remote at this area when selecting channels, adjusting volume, etc.

## ⑧ FRONT INPUT JACKS (for VIDEO: 5)

Use these audio/video jacks for a quick hook-up from a camcorder or VCR to instantly view your favorite show or new recording. press the VID5 button on the remote control button and VIDEO: 5 appears in the top right corner of the TV screen. If you have mono sound, insert the audio cable into the left audio jack.

## ⑨ PHONES JACK

Use this jack for your head-phones. The TV's internal speakers can also be heard. Turn off the internal speakers (see page 48) if you wish to listen to the head-phones only.

## ⑩ LEARNING AV NET Sensor

Point your equipment's remote control at this area while using the AV NET Learning Wizard.

- NOTES:**
- Your HITACHI Plasma TV will appear to be turned OFF (lights orange) if there is no video input when VIDEO: 1, 2, 3, 4, 5, or RGB is selected. Check the Power Light to make sure the Display Monitor is turned off or in Stand-by mode (lights red) when not in use.
  - Remote Control can not turn ON/OFF the "MAIN POWER" of the display monitor.

# REAR PANEL JACKS



FIRST TIME USE

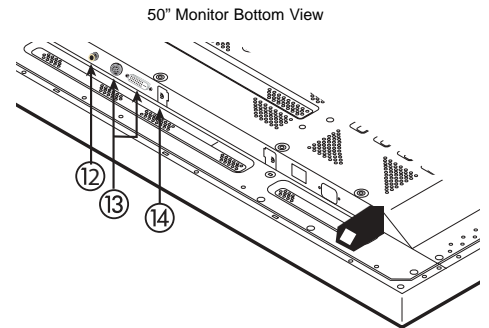
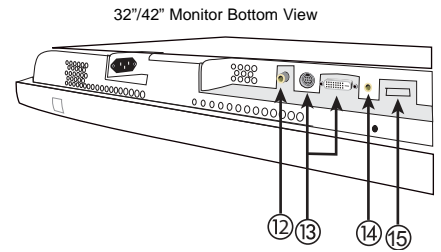
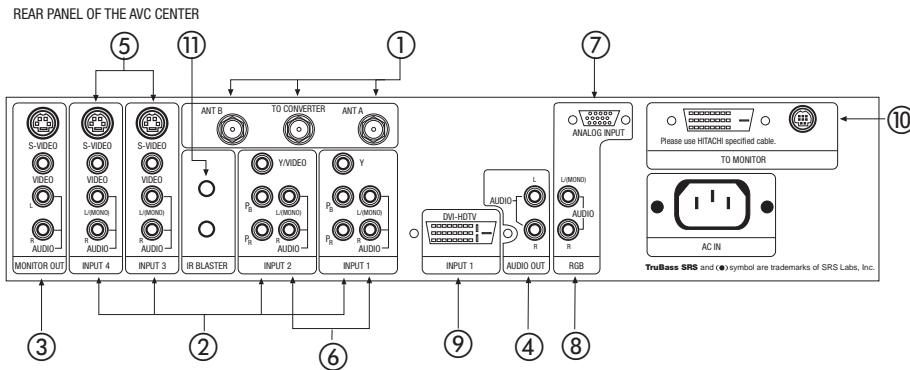

## ① Antenna Input/Output

The remote control allows you to switch between two separate 75-Ohm RF antenna inputs, ANT A and ANT B. ANT A input can be displayed as a main picture or sub-picture. ANT B can only be displayed as a main picture (ANT B cannot be displayed as a sub-picture). The antenna output labeled "TO CONVERTER" allows the ANT A connection to pass directly to a different source such as a cable box, only when ANT B is displayed as a main picture.

## ② Audio/Video Inputs 1, 2, 3 and 4

The VID1~VID4 buttons will select each video source each time they are pressed. Use the audio and video inputs to connect external devices, such as VCRs, camcorders, laserdisc players, DVD players etc. (if you have mono sound, insert the audio cable into the left audio jack).

## ③ MONITOR OUT

These jacks provide fixed audio and video signals (ANT A/B, INPUT 2~5) which are used for recording. Use the S-VIDEO Output for high quality video output. Component signal to Input 1 and 2, RGB and DVI-HDTV inputs will not have monitor output.

## ④ AUDIO OUT

These jacks provide fixed audio output for all audio sources (ANT A/B, INPUT1~5, and RGB) to a separate stereo amplifier.

## ⑤ S-VIDEO Inputs 3 and 4

Inputs 3 and 4 provide S-VIDEO (Super Video) jacks for connecting equipment with S-VIDEO output capability.

- NOTES:**
1. You may use VIDEO or S-VIDEO inputs to connect to INPUT 3 and 4, but only one of these inputs may be used at a time.
  2. S-VIDEO output may be used for recording, only when the input is of S-VIDEO type.

## ⑥ Component: Y-P<sub>B</sub>P<sub>R</sub> Inputs

Inputs 1 and 2 provide Y-P<sub>B</sub>P<sub>R</sub> jacks for connecting equipment with this capability, such as a DVD player or Set Top Box. You may use composite video signal for INPUT 2. INPUT 1 does not accept composite video signal.

- NOTES:**
1. DO NOT connect composite VIDEO and S-VIDEO to Input 3, 4 or 5 at the same time. S-Video has a higher priority over video input.
  2. Your component outputs may be labeled Y, B-Y, and R-Y. In this case, connect the components B-Y output to the AVC Box's P<sub>B</sub> input and the components R-Y output to the AVC Box's P<sub>R</sub> input.
  3. Your component outputs may be labeled Y-C<sub>B</sub>C<sub>R</sub>. In this case, connect the component C<sub>B</sub> output to the AVC Box's P<sub>B</sub> input and the component C<sub>R</sub> output to the AVC Box's P<sub>R</sub> input.
  4. It may be necessary to adjust TINT to obtain optimum picture quality when using the Y-P<sub>B</sub>P<sub>R</sub> inputs (See page 45).
  5. To ensure no copyright infringement, the MONITOR OUT output will be abnormal, when using the Y-P<sub>B</sub>P<sub>R</sub> jacks, RGB and DVI-HDTV inputs.

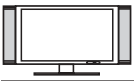

⑦ **RGB - Analog Input**  
Use this 15-pin D-Sub input for your external devices with RGB output (see page 22).

⑧ **RGB - Audio Input**  
Connect audio for RGB input (if you have mono sound, insert the audio cable into the left audio jack).

⑨ **DVI - HDTV - Digital Input**  
Use this DVI Digital input for your external devices with digital output capability, such as a Set-Top-Box, high band DTV decoders and DVD players with digital content protection (see page 22). DVI is INPUT 1 and has priority over component input. When DVI is used, hook up audio to INPUT 1.

**NOTE:** When using a Set-Top-Box, it is recommended to use a 1080i or 720p input signal.

⑩ **To Monitor**  
Connect the Monitor Connection Cable to the AVC center's "TO MONITOR" connector, and to the display monitor's "FROM AVC" connector.

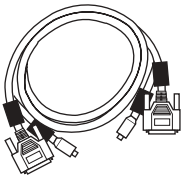

⑪ **IR Blaster**  
This jack provides IR output to your external components (VCR, Cable box, DVD player, etc.). With this connection, your external components can automatically be controlled by the A/V network feature. This connection will allow you to control the external components with your Plasma Television's remote control in TV mode.

⑫ **Subwoofer Out**  
Connect this SUB WOOFER OUT output to the external audio component input using the sub woofer cable provided.

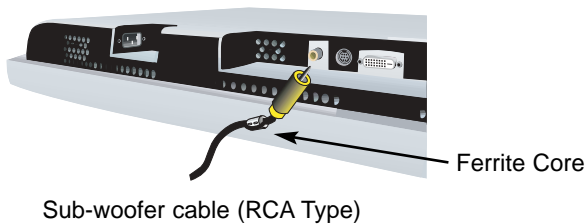

⑬ **To AVC**  
Connect the Monitor Connection cable from the AVC center's "TO MONITOR" to these connectors ("FROM AVC").

⑭ **SUB-POWER button**  
This power is for serviceman usage.

⑮ **To Power Swivel base (32" and 42" Only)**  
Connects the plasma monitor to the power swivel base using a connection cable.

**NOTES:** 1. Squeeze both ends of the cable connector before inserting or disconnecting from the monitor and power swivel base.  
2. The monitor base and the power swivel connection cable must be disconnected before wall mount installation.

# CONNECTING PLASMA DISPLAY MONITOR TO AVC BOX

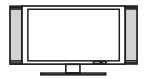

1. From the owner's accessory you will find the Monitor Connector cable.
2. Firmly, and securely insert the Monitor Connection Cable to the rear panel of the AVC box "TO MONITOR" connectors.
3. Insert the other ends of the Monitor Connection Cable to the display monitor rear panel "FROM AVC" connectors.

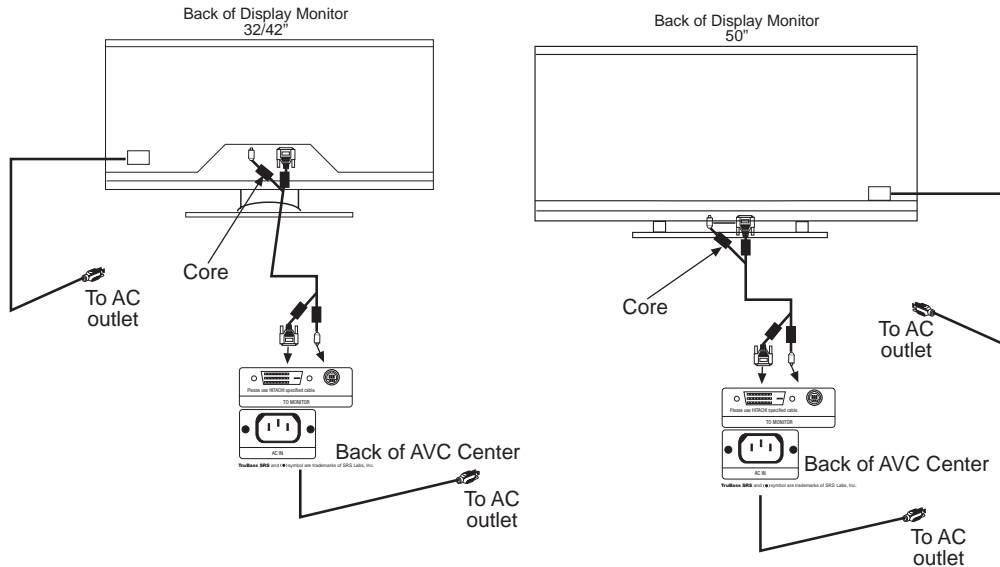

FIRST TIME USE

**NOTE:** The Display Monitor and the AVC Center have their own AC Power. Both AC cords must be completely plugged in to the AVC Center and the display monitor, then plug them in to the AC outlets.

# CONNECTING EXTERNAL VIDEO SOURCES

The front panel jacks are provided as a convenience to allow you to easily connect a camcorder or VCR as shown in the following examples:

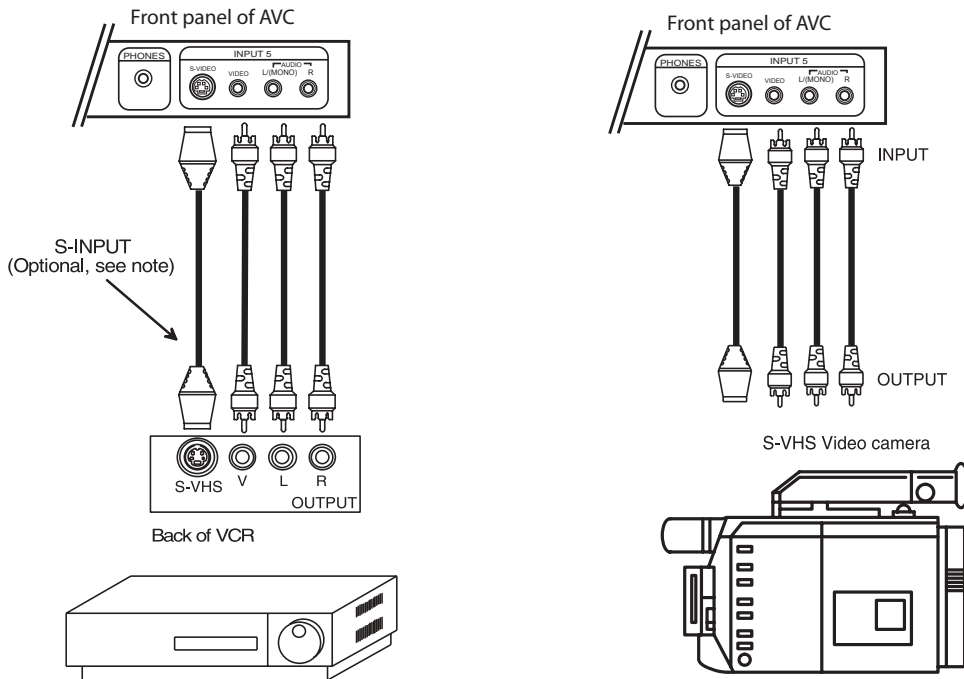

- NOTES:**
1. Completely insert connection cord plugs when connecting to front panel jacks. If you do not, the played back picture may be abnormal.
  2. If you have a S-VHS VCR, use the S-INPUT cable in place of the standard video cable.
  3. If you have a mono VCR, insert the audio cable into the left audio jack of your AVC box.
  4. S-VIDEO input takes priority over VIDEO input.
  5. If you have a VHS or 8mm camcorder, use the S-VIDEO cable in place of the VIDEO cable.



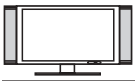

# CONNECTING EXTERNAL VIDEO SOURCES

FIRST TIME USE

The exact arrangement you use to connect the VCR, camcorder, laserdisc player, DVD player, or HDTV Set Top Box to your Plasma TV is dependent on the model and features of each component. Check the owner's manual of each component for the location of video and audio inputs and outputs.

The following connection diagrams are offered as suggestions. However, you may need to modify them to accommodate your particular assortment of components and features. For best performance, video and audio cables should be made from coaxial shielded wire.

## Before Operating External Video Source

The input mode is changed when the VID1~VID5 button is pressed as shown below. Connect an external source to the INPUT terminal, then press the VID1~VID5 button as necessary to view the input source (see page 31).

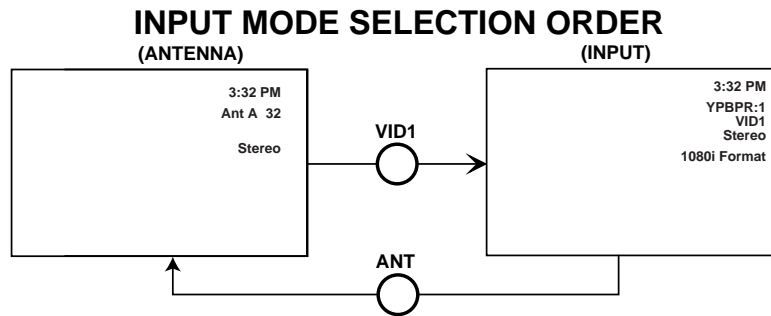

## CONNECTING A MONAURAL AUDIO SOURCE TO INPUT2~INPUT5

1. Connect the cable from the VIDEO OUT of the VCR or the laserdisc player to the INPUT (VIDEO) jack, as shown on the AVC Center below.
2. Connect the cable from the AUDIO OUT of the VCR or the laserdisc player to the INPUT (MONO)/L(AUDIO) jack.
3. Press the VID2~VID5 button to view the program from the VCR or the laserdisc player. The VIDEO mode disappears automatically after approximately four seconds.
4. Press the ANT button to return to the previous channel.

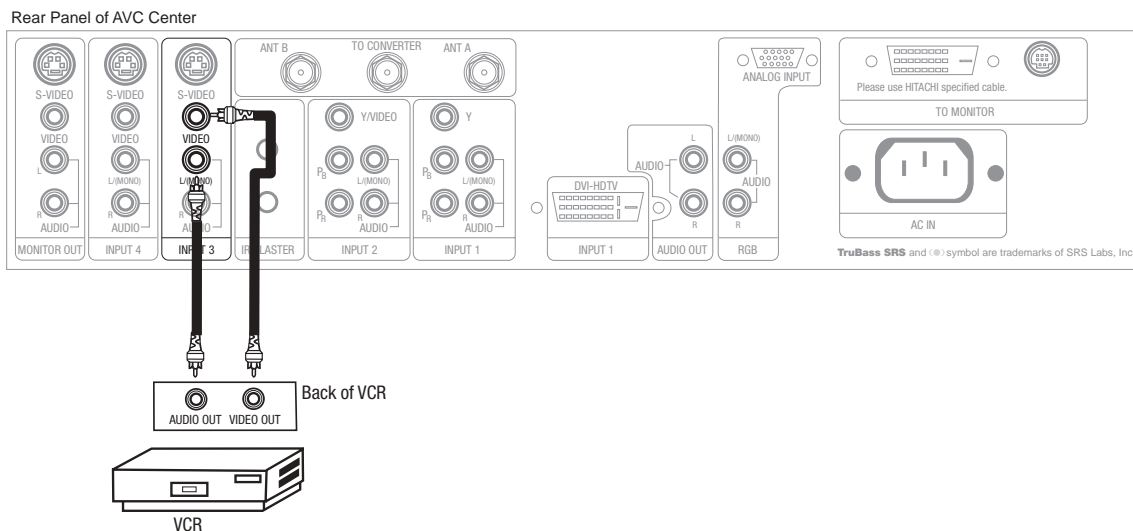

# CONNECTING EXTERNAL VIDEO SOURCES

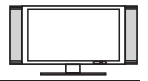

## CONNECTING A STEREO VCR OR STEREO LASERDISC PLAYER

1. Connect the cable from the VIDEO OUT of the VCR or the laserdisc player to the INPUT (VIDEO) jack, as shown on the AVC Center below.
2. Connect the cable from the AUDIO OUT R of the VCR or the laserdisc player to the INPUT (AUDIO/R) jack.
3. Connect the cable from the AUDIO OUT L of the VCR or the laserdisc player to the INPUT (AUDIO/L) jack.
4. Press the VID2~VID5 button to view the program from the VCR or laserdisc player. The VIDEO label disappears automatically after approximately four seconds.
5. Press the ANT button to return to the previous channel.

Rear Panel of AVC Center

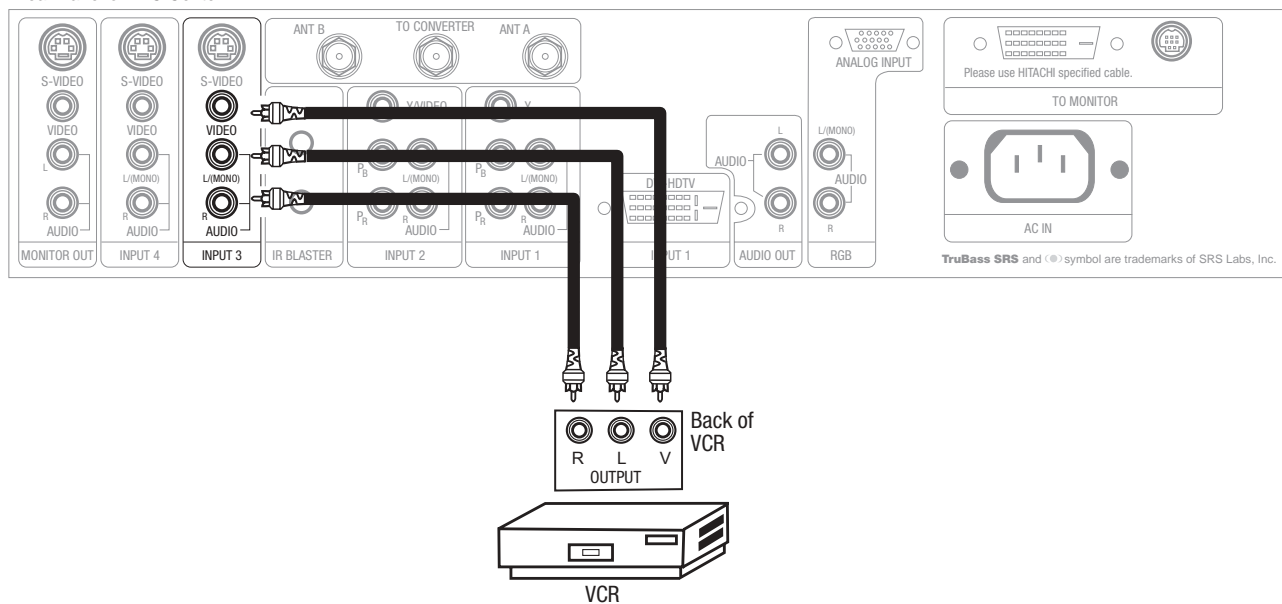

- NOTES:**
1. Completely insert the connection cord plugs when connecting to rear panel jacks. The picture and sound that is played back will be abnormal if the connection is loose.
  2. A single VCR can be used for VCR #1 and VCR #2, but note that a VCR cannot record its own video or line output (INPUT: 4 in example on page 22). Refer to your VCR operating guide for more information on line input-output connections.



# CONNECTING EXTERNAL VIDEO SOURCES

## CONNECTING S-VIDEO VCR OR LASERDISC PLAYER

1. Connect the cable from the S-VIDEO OUT of the S-VHS VCR or the laserdisc player to the INPUT (S-VIDEO) jack, as shown on the AVC Center below.
2. Connect the cable from the AUDIO OUT R of the VCR or the laserdisc player to the INPUT (AUDIO/R) jack.
3. Connect the cable from the AUDIO OUT L of the VCR or the laserdisc player to the INPUT (AUDIO/L) jack.
4. Press the VID3~VID5 button to view the program from the VCR or laserdisc player. The VIDEO label disappears automatically after approximately four seconds.
5. Press the ANT button to return to the previous channel.

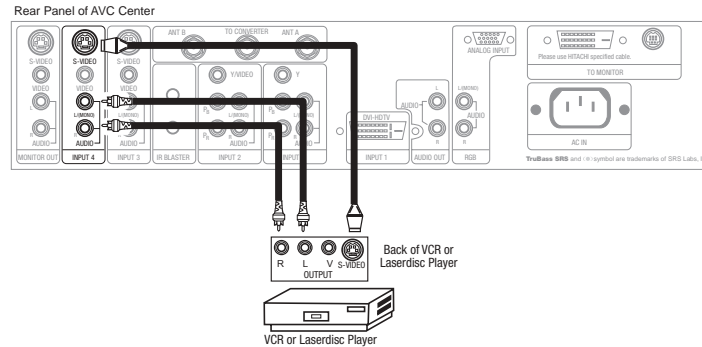

- NOTES:**
1. Completely insert the connection cord plugs when connecting to rear panel jacks. The picture and sound that is played back will be abnormal if the connection is loose.
  2. A single VCR can be used for VCR #1 and VCR #2, but note that a VCR cannot record its own video or line output (INPUT: 4 in example on page 22). Refer to your VCR operating guide for more information on line input-output connections.

## CONNECTING A COMPONENT SOURCE WITH DVI-HDTV CAPABILITY TO INPUT 1

1. Connect the DVI connection cable from the output of the HDTV set top box or DVD player to the DVI-HDTV input as shown on the AVC Center below.
2. Connect the cable from the AUDIO OUT R of the HDTV set top box or DVD player to the INPUT (AUDIO/R) jack.
3. Connect the cable from the AUDIO OUT L of the HDTV set top box or DVD player to the INPUT (AUDIO/L) jack.
4. Press the VID1 button to view the program from the HDTV set top box or DVD player. The VIDEO OSD label disappears automatically after approximately four seconds.
5. Press the ANT button to return to the previous channel.

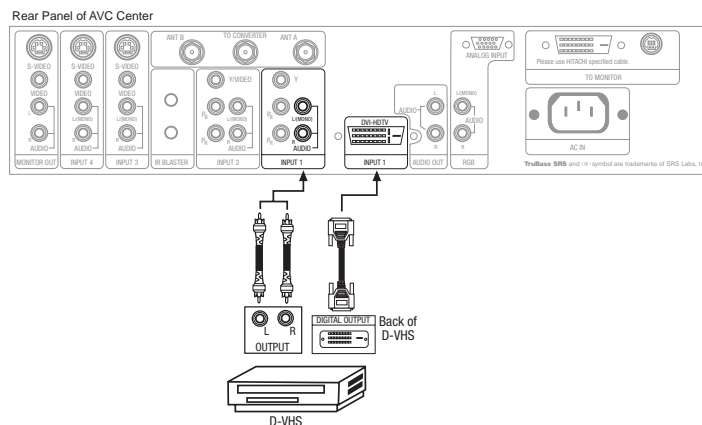

- NOTES:**
1. Completely insert the connection cord plugs when connecting to rear panel jacks. The picture and sound that is played back will be abnormal if the connection is loose.
  2. The DVI-HDTV input on INPUT 1 contains the copy protection system called High-bandwidth Digital Content Protection (HDCP). HDCP is a cryptographic system that encrypts video signals when using DVI connections to prevent illegal copying of video contents.
  3. DVI is not a "NETWORK" technology. It establishes a one-way point-to-point connection for delivery of uncompressed video to a display.
  4. The connected digital output device controls the DVI interface so proper set-up of device user settings determines final video appearance.

# CONNECTING EXTERNAL VIDEO SOURCES



## CONNECTING A STEREO LASERDISC/DVD PLAYER OR HDTV SET TOP BOX TO INPUT 1 OR 2 COMPONENT: Y-P<sub>B</sub>P<sub>R</sub>.

1. Connect the cable from the Y OUT of the Laserdisc/DVD player or HDTV set top box to the INPUT (Y) jack, as shown on the AVC Center below.
2. Connect the cable from the C<sub>B</sub>/P<sub>B</sub> OUT or B-Y OUT of the Laserdisc/DVD player or HDTV set top box to the INPUT (P<sub>B</sub>) jack.
3. Connect the cable from the C<sub>R</sub>/P<sub>R</sub> OUT or R-Y OUT of the Laserdisc/DVD player or HDTV set top box to the INPUT (P<sub>R</sub>) jack.
4. Connect the cable from the AUDIO OUT R of the Laserdisc/DVD player or HDTV set top box to the INPUT (AUDIO/R) jack.
5. Connect the cable from the AUDIO OUT L of the Laserdisc/DVD player or HDTV set top box to the INPUT (AUDIO/L) jack.
6. Press the VID1/VID2 button, to view the program from the Laserdisc/DVD player or HDTV set top box. The VIDEO label disappears automatically after approximately four seconds.
7. Press the ANT button to return to the previous channel.

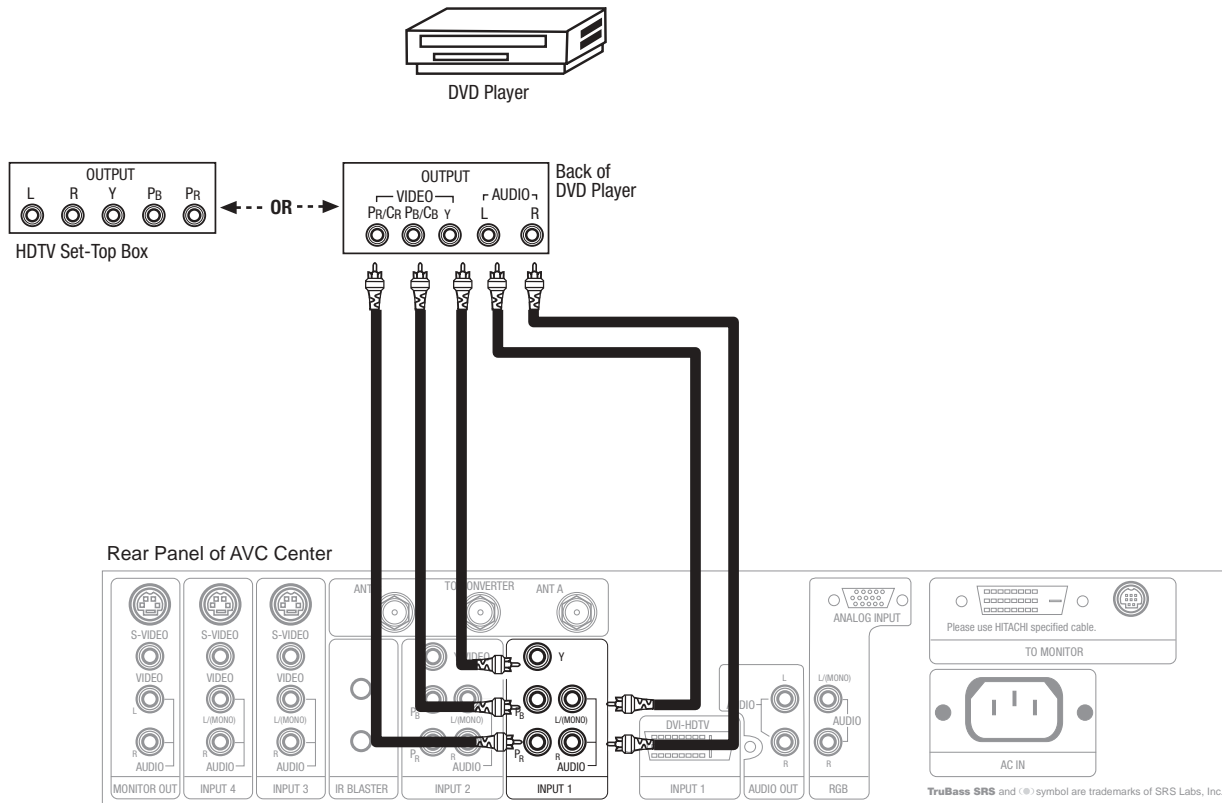

- NOTE:**
1. Completely insert the connection cord plugs when connecting to rear panel jacks. The picture and sound that is played back will be abnormal if the connection is loose.
  2. See page 23 for tips on REAR PANEL CONNECTIONS.

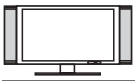

# CONNECTING EXTERNAL AUDIO/VIDEO DEVICES

FIRST TIME USE

## CONNECTING EXTERNAL AUDIO AMPLIFIER

To monitor the audio level of the Plasma TV to an external audio amplifier, connect the system as shown below. The "AUDIO OUT" from the AVC center is a fixed output. The Volume of the amplifier is controlled by the amplifier, not by the Plasma Television. The AUDIO OUT terminal outputs all audio sources (ANT A/B, INPUT 1~5 and RGB).

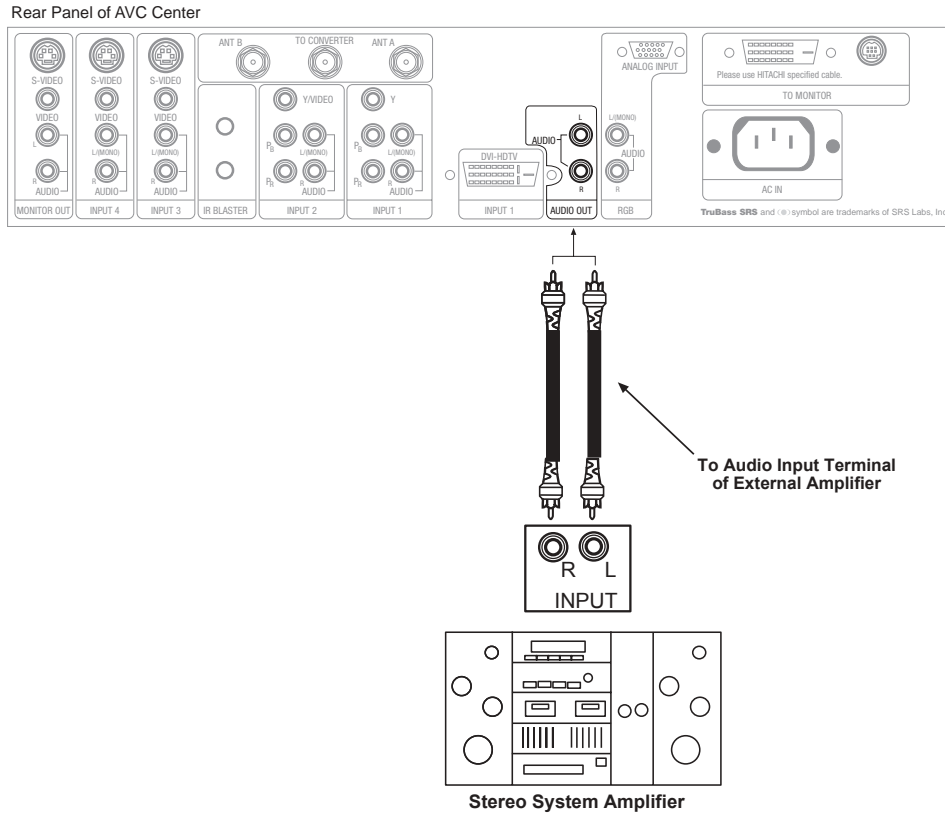

The MONITOR OUT terminal outputs video and audio of ANT A/B and INPUT2~5 only. It does not output component video, DVI-HDTV or RGB. If a component device is input to INPUT2, no monitor out is available for this output.

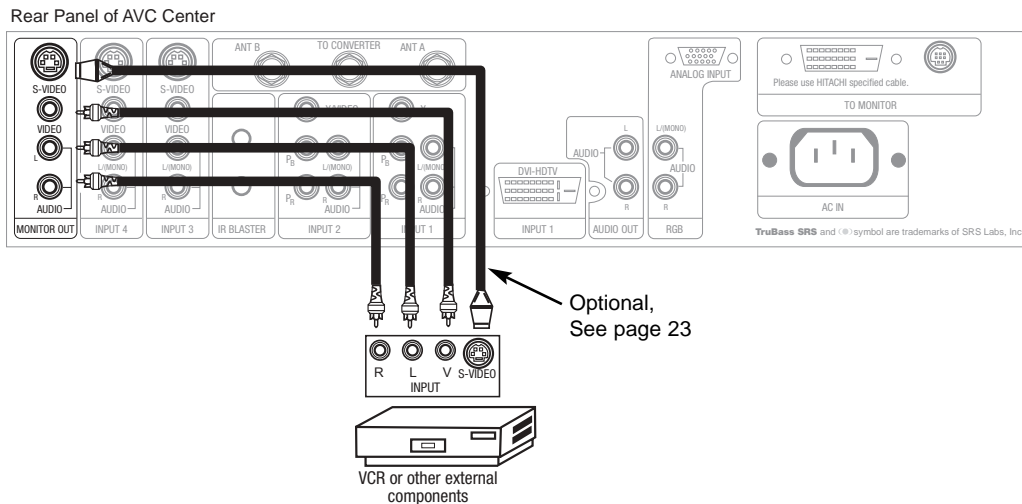



# CONNECTING AV NETWORK

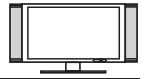

FIRST TIME USE

Your Hitachi Plasma Television is equipped with an AV Network feature. This feature helps to control your external Audio/Video equipment (VCR, Set Top Box, DVD, etc.). Once this is setup, it allows your IR Mouse connector to control your equipment using your Hitachi Plasma TV Remote Control. You can use your Hitachi remote control to control the Audio/Video equipment command without the equipment's remote control.

The Plasma Television AVC Center has 2 IR BLASTER jacks. Each IR Mouse cable can connect up to 2 external Audio/Video components. Therefore, you can connect the Plasma Television with up to four components. Please see the following example of an AV Network setup between your Hitachi Plasma Television and external Audio/Video equipment (VCR and DVD Player).

## CONNECTING EXTERNAL AUDIO/VIDEO COMPONENTS TO IR BLASTER FOR AV NETWORK

1. Connect your external Audio/Video components to the AVC Center shown on pages 13~18.
2. Connect the IR Mouse cable to the IR BLASTER output of the AVC Center.
3. Place the IR mouse in front of the infrared sensor of the external components you wish to control.

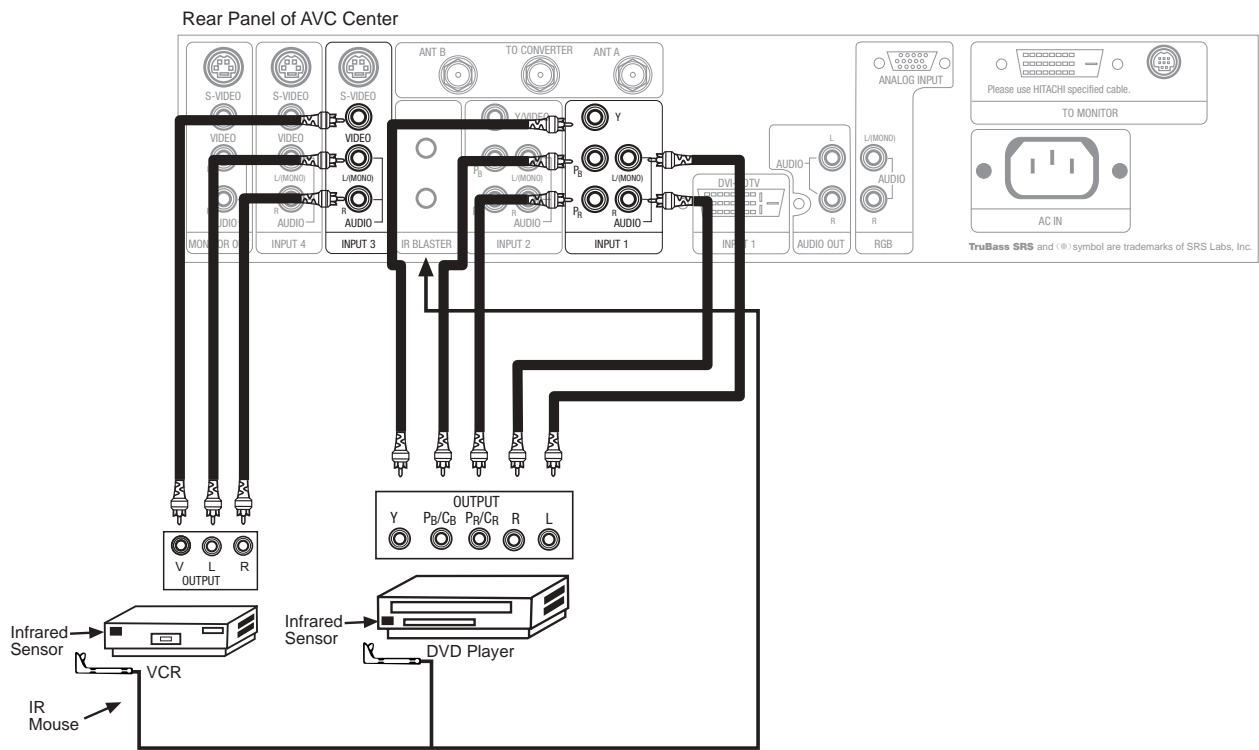

4. Press the AV NET button on the remote control. Use THUMB STICK ▲ or ▼ to highlight the component you wish to set up. Use THUMB STICK ► to enter component's "SOFT KEY" control button. The AV Network Setup Wizard will automatically start upon the very first use. You can access the Setup Menu Wizard again in the future by pressing the AV net button and then pressing the INFO button.

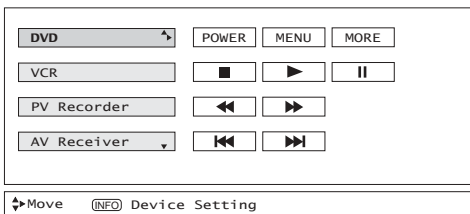

**NOTES:**

1. The AVC Center has two IR BLASTER outputs which can control up to a total of four external components.
2. The IR Mouse must be placed in front of the external components infrared sensor for the AV Network to work.
3. The correct codes must be entered for each of the Audio/Video components for the AV Network to function properly.
4. Audio/Video component codes for AV network are on page 21.



# AV NETWORK SETUP WIZARD

FIRST TIME USE

5. Follow the steps below to setup your AV network (See page 21 for AV Network Codes).

There are six steps in the setup procedure (DVD setup example below).

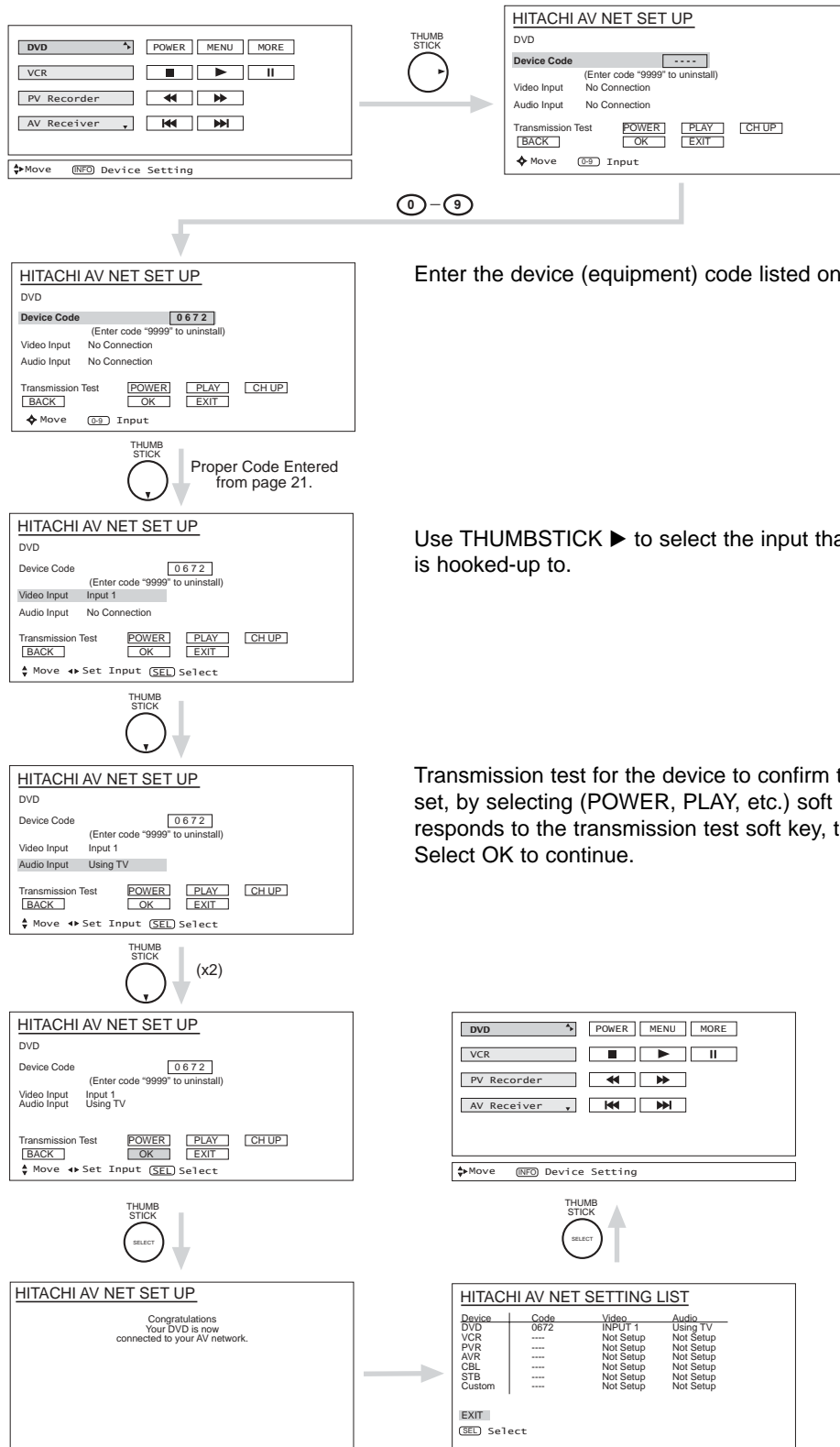

Enter the device (equipment) code listed on page 21.

Use THUMBSTICK ► to select the input that the device (equipment) is hooked-up to.

Transmission test for the device to confirm that the proper code was set, by selecting (POWER, PLAY, etc.) soft keys shown. If the device responds to the transmission test soft key, then it is properly set up. Select OK to continue.

- 6. To uninstall or change device (equipment), press INFO button on the remote control when the device (DVD, VCR, etc.) is highlighted.
- 7. See Remote Control AV NET button usage on pages 27 and 28.

# AUDIO/VIDEO CODES FOR AV NETWORK (not for remote control)



<b>VCR BRAND</b> .....	<b>CODE</b>	Shogun .....	0240	Supercable .....	0276	Marantz .....	1089, 1189, 0039, 0128, 0189
Admiral .....	0048, 0209	Singer .....	0072	Tocom .....	0012	Modulaire .....	0195
Adventura .....	0000	Sonic Blue .....	0614, 0616	Torx .....	0003	Musimagic .....	1089
Aiko .....	0278	Sony .....	0035, 0032, 0000, 0033, 0636, 1032, 1232	Toshiba .....	0000	NAD .....	0320
Aiwa .....	0000, 0037	Sylvania .....	0035, 0081, 0000, 0043, 1781	Zenith .....	0000, 0525, 0899	NEC .....	0235
Akai .....	0041	Symphonic .....	0000			Nakamichi .....	0097, 0347
America Action .....	0278	TMK .....	0240			Onkyo .....	0100, 0135, 0380, 0842, 1298
American High .....	0035	Tatung .....	0041			Optimus .....	1023, 0042, 0080, 0177, 0181, 0186, 0219, 0531, 0670, 0738, 0801, 1074
Asha .....	0240	Teac .....	0000, 0041			Panasonic .....	0367, 0518, 1288, 1350
Audiovox .....	0037, 0278	Technics .....	0035, 0162			Penney .....	0195
Beaumarck .....	0240	Teknika .....	0000, 0035, 0037			Philips .....	1089, 1189, 1269, 0189, 0391, 1120, 1268, 1283
Bell & Howell .....	0104	Thomas .....	0000			Pioneer .....	1023, 0014, 0080, 0150, 0244, 0531, 0630, 1343, 1384
Broksonic .....	0121, 0184, 0002, 0209, 0479, 1479, 0278	Tivo .....	0618, 0636			Polk Audio .....	0189
CCE .....	0072, 0278	Toshiba .....	0045, 0043, 845			Proscan .....	1254
Calix .....	0037	Totevision .....	0037, 0240			Quasar .....	0039
Canon .....	0035	Unitech .....	0240			RCA .....	1023, 1254, 0054, 0080, 0346, 0360, 0530, 0531, 1074, 1154, 1390, 1609
Carver .....	0081	Vector .....	0045			Radio Shack .....	0189
Cineral .....	0278	Vector Research .....	0038			Realistic .....	0163, 0181, 0195
Citizen .....	0278, 0037, 1278	Video Concepts .....	0045			Samsung .....	1295
Colt .....	0072	Video Magic .....	0037			Sansui .....	0189, 1089, 0193, 0346
Craig .....	0037, 0072, 0047, 0240	Videosonic .....	0240			Sanyo .....	0219, 0801, 1251
Curtis Mathes .....	0035, 0041, 0060, 0162, 0760, 1035	Wards .....	0060, 0035, 0048, 0047, 0081, 0240, 0000, 0042, 0072, 0149, 0760			Scott .....	0163, 0322
Cybernex .....	0240	White Westinghouse .....	0072, 1278, 0209			Sharp .....	0186
Daewoo .....	0278, 1278, 0045	XR-1000 .....	0072, 0000, 0035			Sherwood .....	0062, 0491, 0502, 1653
Denon .....	0042	Yamaha .....	0038			Sony .....	0168, 0474, 1042, 1458, 1758
Dynatech .....	0000	Zenith .....	0039, 0000, 0209, 0033, 0479, 1479, 0033, 0034, 0209, 0479			Soundesign .....	0670
Electrohome .....	0037					Stereophonics .....	1023
Electrohome .....	0037					Sunfire .....	1313, 0313, 0314, 1052
Emerex .....	0032					Teac .....	0463, 0163, 1074
Emerson .....	0184, 0002, 0209, 0121, 0000, 0037, 0043	<b>DVD BRAND</b> .....	<b>CODE</b>			Technics .....	0039, 0208, 0309, 0518
Fisher .....	0104, 0047	Aiwa .....	0641			Thorens .....	1189
Fuji .....	0033, 0035	Apex .....	0672, 0717, 0755, 0794, 0795, 0796, 0797, 0830			Victor .....	0074
Funai .....	0000	Audiologic .....	0736			Wards .....	0014, 0054, 0080, 0158, 0189
GE .....	0035, 0060, 0240, 0760, 0807, 1035, 1060	B & K .....	0655, 0662			Yamaha .....	0176, 0186, 1176
Garrard .....	0000	Blue Parade .....	0571			Zenith .....	0195, 0857
Go Video .....	0432	Broksonic .....	0695				
GoldStar .....	0037, 0038, 1237	DVD2000 .....	0521				
Gradiente .....	0000	Daewoo .....	0784				
Hi-Q .....	0047	Denon .....	0490, 0634				
Harley Davidson .....	0000	Emerson .....	0591				
Harman/Kardon .....	0038, 0081	Enterprise .....	0591				
Harwood .....	0072	Fisher .....	0670				
Hitachi .....	0000, 0041, 0042	GE .....	0522, 0717, 0815				
Hughes Network Systems .....	0042	GPX .....	0699, 0769				
JVC .....	0067, 0041	Go Video .....	0715				
Jensen .....	0041	Gradiente .....	0651				
KEC .....	0037, 0278	Greenhill .....	0717				
KLH .....	0072	Harman/Kardon .....	0582, 0702				
Kenwood .....	0041, 0067, 0038	Hitachi .....	0490, 0573, 0664				
Kodak .....	0035, 0037	Hitek .....	0672				
LXI .....	0037	JBL .....	0702				
Lloyd's .....	0000	JVC .....	0623, 0558, 0867				
Logik .....	0072	KLH .....	0717				
MEI .....	0035	Kenwood .....	0490, 0534, 0682				
MGA .....	0043, 0240	Konka .....	0711, 0719, 0721				
MGN Technology .....	0240	Koss .....	0651				
MTC .....	0000, 0240	Lasonic .....	0503, 0675				
Magnasonic .....	1278	Magnavox .....	0782				
Magnavox .....	0035, 0081, 0563, 0000, 0039, 0149, 1781	Malata .....	0539				
Magnin .....	0240	Marantz .....	0522				
Marantz .....	0081, 0035	Microsoft .....	0717				
Marta .....	0037	Mintek .....	0521				
Matsushita .....	0035, 0162, 0454	Mitsubishi .....	0717				
Memorex .....	0047, 0037, 0104, 0209, 0454, 0048, 0039, 0240, 0000, 0479, 1037, 1162, 1237, 1262	Nesa .....	0627, 0503				
Minolta .....	0042	Onkyo .....	0651				
Mitsubishi .....	0807, 0043, 0067	Orion .....	0490, 1362, 0632				
Motorola .....	0035, 0048	Panasonic .....	0503, 0539, 0646, 0854				
Multitech .....	0000, 0072	Philips .....	0525, 0571, 0632				
NEC .....	0038, 0041, 0067, 0104	Pioneer .....	0539				
Nikko .....	0037	Polk Audio .....	0674				
Noblex .....	0240	Princeton .....	0522				
Olympus .....	0035	Proscan .....	0522				
Optimus .....	1062, 0162, 0037, 0048, 0104, 0432, 0454, 1048, 1162, 1262	RCA .....	0522, 0571, 1022, 0717				
Orion .....	0184, 0209, 0002, 0479, 1479	Samsung .....	0573, 0820				
Panasonic .....	1062, 0035, 01625, 0225, 0454, 0616, 1035, 1162, 1262	Sansui .....	0695				
Penney .....	0035, 0037, 0240, 0042, 0038, 1035, 1237	Sanyo .....	0670				
Pentax .....	0042	Sharp .....	0630				
Philco .....	0035, 0209, 0479	Sherwood .....	0633				
Philips .....	0081, 0035, 0618, 1081, 1181	Sony .....	0533				
Pilot .....	0037	Sylvania .....	0675				
Pioneer .....	0067	Technics .....	0490				
Polk Audio .....	0081	Techwood .....	0692				
Proffronic .....	0240	Theta Digital .....	0571				
Proscan .....	0060, 0760, 1060	Toshiba .....	0503, 0695				
Protac .....	0072	Urban Concepts .....	0503				
Pulsar .....	0039	Yamaha .....	0490, 0545, 0539				
Quasar .....	0035, 0162, 0454, 1035, 1162	Zenith .....	0591, 0503				
RCA .....	0060, 0240, 0042, 0149, 0760, 0807, 1035, 1060						
Radio Shack .....	0000, 1037	<b>CABLE BRAND</b> .....	<b>CODE</b>				
Radix .....	0037	ABC .....	0003, 0008, 0014, 0017				
Randex .....	0037	Americast .....	0899				
Realistic .....	0035, 0037, 0048, 0047, 0000, 0104	Bell & Howell .....	0014				
ReplayTV .....	0614, 0616	Bell South .....	0899				
Runco .....	0039	Director .....	0476				
STS .....	0042	General Instrument .....	0003, 0476, 0276, 0810				
Samsung .....	0045, 0240	GoldStar .....	0144				
Sanky .....	0039, 0048	Hamlin .....	0009, 0273				
Sansui .....	0000, 0067, 0209, 0041, 0479, 1479	Jerrold .....	0476, 0003, 0276, 0012, 0014, 0810				
Sanyo .....	0047, 0240, 0104	Memorex .....	0000				
Scott .....	0184, 0045, 0121, 0043	Motorola .....	0476, 1106, 0276, 0810				
Sears .....	0035, 0037, 0047, 0000, 0042, 0104, 1237	Pace .....	0237				
Semp .....	0045	Panasonic .....	0107, 0000				
Sharp .....	0048, 0807, 0848	Philips .....	0305, 0317				
Shintom .....	0072	Pioneer .....	0144, 0533, 0877, 1877				
		Pulsar .....	0000				
		Quasar .....	0000				
		Regal .....	0273, 0279				
		Runco .....	0000				
		Samsung .....	0144				
		Scientific Atlanta .....	0877, 0008, 0017, 0477, 1877				
		Sony .....	1006				
		Starcom .....	0003				

FIRST TIME USE

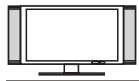

# REAR PANEL CONNECTIONS

FIRST TIME USE

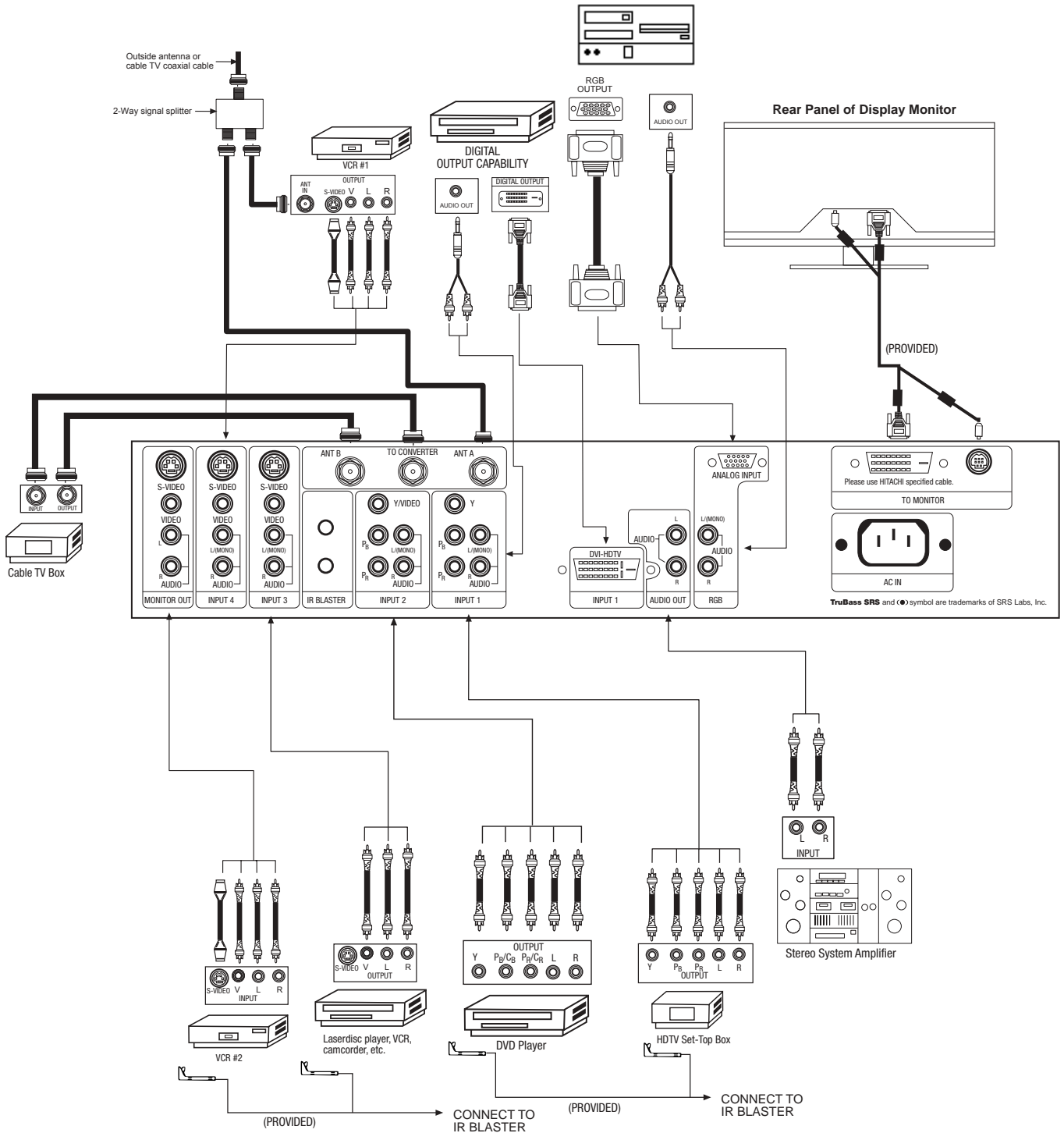

**NOTE:** Cables are optional, except when specified.

# TIPS ON REAR PANEL CONNECTIONS



- S-VIDEO connections are provided for high performance laserdisc players, VCRs etc. that have this feature. Use these connections in place of the standard video connection if your device has this feature.
- If your device has only one audio output (mono sound), connect it to the left audio jack on the AVC Center.
- Refer to the operating guide of your other electronic equipment for additional information on connecting your hook-up cables.
- A single VCR can be used for VCR #1 and VCR #2, but note that a VCR cannot record its own video or line output (INPUT: 4 in the example on page 22). Refer to your VCR operating guide for more information on line input-output connections.
- Connect only 1 component (VCR, DVD player, camcorder, etc.) to each input jack.
- COMPONENT: Y-P<sub>B</sub>P<sub>R</sub> (Input 1 & 2) connections are provided for high performance components, such as DVD players and set-top-boxes. Use these connections in place of the standard video connection if your device has this feature.
- Your component outputs may be labeled Y, B-Y, and R-Y. In this case, connect the components B-Y output to the TV's P<sub>B</sub> input and the components R-Y output to the TV's P<sub>R</sub> input.
- Your component outputs may be labeled Y-C<sub>B</sub>C<sub>R</sub>. In this case, connect the components C<sub>B</sub> output to the TV's P<sub>B</sub> input and the components C<sub>R</sub> output to the TV's P<sub>R</sub> input.
- It may be necessary to adjust TINT to obtain optimum picture quality when using the Y-P<sub>B</sub>P<sub>R</sub> inputs. (See page 45)
- To ensure no copyright infringement, the MONITOR OUT output will be abnormal, when using the Y-P<sub>B</sub>P<sub>R</sub>, RGB and DVI-HDTV input jacks.
- Input 1 can accept component Y-P<sub>B</sub>P<sub>R</sub> signal and DVI signal (No composite signal).
- Input 2 can accept both component Y-P<sub>B</sub>P<sub>R</sub> and composite video signal.
- You may use VIDEO or S-VIDEO inputs to connect to INPUT 3, 4 or 5, but only one of these, VIDEO or S-VIDEO, may be used at a time for each input. S-VIDEO has priority over VIDEO.
- S-VIDEO monitor output may be used for recording only when the input is of S-VIDEO type.
- When using a DVI input from a Set-Top-Box, it is recommended to use a 1080i or 720p input signal.





# REMOTE

In addition to controlling all the functions on your HITACHI Plasma TV, the new remote control is designed to operate different types of VCRs, CATV (Cable TV) converters, set-top-box, satellite receiver, DVD players, and other audio/video equipment with one touch. Basic operation keys are grouped together in one area.

To operate your Plasma TV, point the remote control at the remote sensor of the AVC box/Display Monitor and press the TV button. The TV button will blink, indicating that the remote will now control your television.

To operate your VCR, point the remote at the remote sensor of the VCR and press the VCR button. The VCR button will blink, indicating that the remote will now control your VCR (see page 35 for instructions on how to program the remote to control your VCR).

To operate your cable box, point the remote at the remote sensor of the cable box and press the CABLE (CBL) button. The CBL button will blink, indicating that the remote will now control your cable box (see page 36 for instructions on how to program the remote to control your cable box).

To operate your set-top-box or satellite receiver point the remote at the remote sensor of the set-top-box and press the SET-TOP-BOX (STB) button. The STB button will blink, indicating that the remote will now control your set-top-box. If you have a satellite receiver, use this button to program your satellite receiver (see page 37 for instructions on how to program the remote to control your set-top-box).

To operate your DVD player, point the remote at the remote sensor of the DVD player and press the DVD button. The DVD button will blink, indicating that the remote will now control your DVD player (see page 38 for instructions on how to program the remote to control your DVD player).

To operate additional audio equipment, point the remote at the remote sensor of the component you wish to control and press the CD, PVR or AMP button. This button will blink, indicating that the remote will now control the desired component (see page 39 for instructions on how to program the remote to control additional Audio equipment).

## THE REMOTE CONTROL

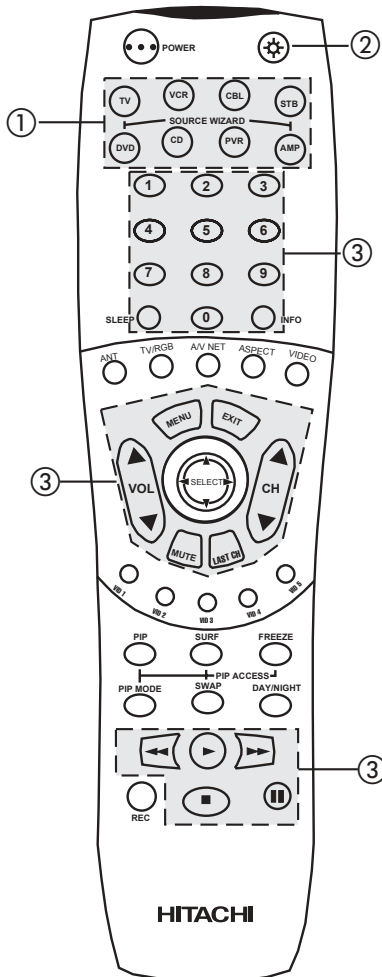

① These buttons allow the remote to control your TV, VCR, cable box, satellite receiver, DVD player, or other Audio equipment depending on which mode is chosen, as explained above.

### ②,③ LIGHT BUTTON

When you are in a dark room, press the light button ② on the remote to light up the buttons shown in ③ and the source button will blink. The light will stay on for about 8 seconds if the light button is not pressed again. These buttons will not appear to illuminate if the room is too bright.

# HOW TO USE THE REMOTE TO CONTROL YOUR PLASMA TV

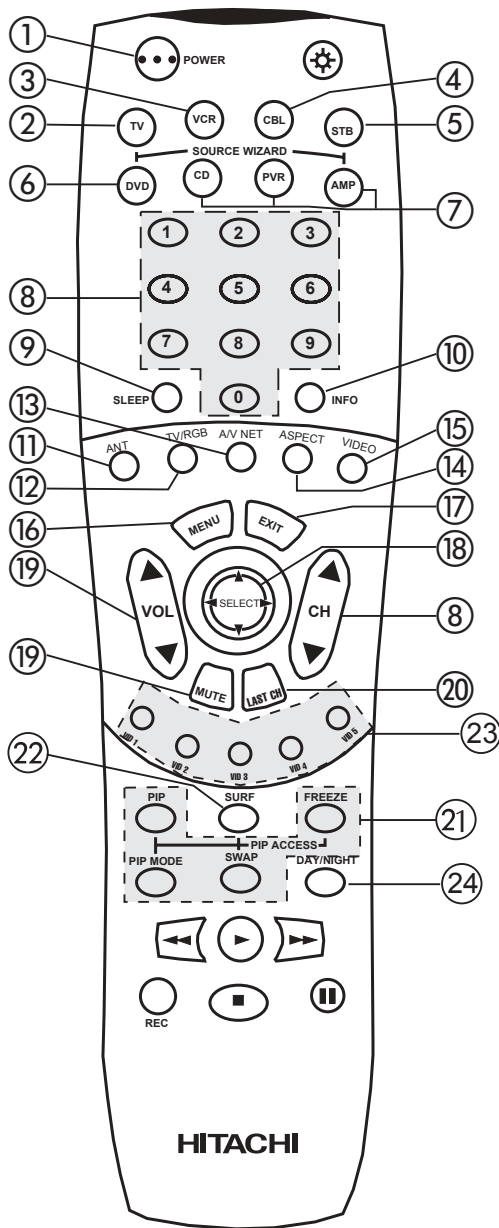

THE REMOTE CONTROL

- ① POWER button**  
Press this button to turn the Plasma TV on or off when the remote is in TV mode (see page 24 for instructions on how to set the remote control to TV mode).
- ② TV button**  
When the TV button is pressed, it will blink, to indicate the remote is in TV mode.
- ③ VCR button**  
When the VCR button is pressed, it will blink to indicate the remote is in VCR mode (see page 35).
- ④ CABLE (CBL)**  
When the CABLE button is pressed, it will blink to indicate the remote is in CABLE mode (see page 36).
- ⑤ SET-TOP-BOX (STB)**  
When the STB button is pressed, it will blink to indicate the remote is in STB mode (see page 37).  
If you have a Satellite receiver, use this button to program your Satellite receiver (see page 37).
- ⑥ DVD button**  
When the DVD button is pressed, it will blink to indicate the remote is in DVD mode (see page 38).



# HOW TO USE THE REMOTE TO CONTROL YOUR PLASMA TV

## 7 CD, PVR, AMP buttons

When pressed, each of these buttons will blink to indicate the remote is in Audio mode or PVR mode (see page 39).

## 8 CHANNEL selector buttons

CHANNEL selector buttons are used to select channels, lock access code, etc.

Enter one, two, or three numbers to select channels. Enter "0" first for channels 1 to 9, or simply press the single digit channel you wish to tune then wait a few seconds for the TV to tune. For channels 100 and above, press the "1" button, wait until two dashes appear next to the channel display on your TV, then enter the remaining two numbers using the number buttons.

Channel selection may also be performed by pressing CH up (▲) or down (▼).

**NOTE:** The Plasma TV may not receive some channels if you are not in the correct ANTENNA/CABLE mode (see page 50).

## 9 SLEEP button

Press this button to display the sleep timer in the lower center of the screen. Every subsequent press of this button will add 15 minutes to this timer, up to a maximum of three hours. Once set, use INFO when you want to view time remaining. If the SLEEP button is pressed while the timer is set, it will reset to the original condition.

## 10 INFO button

Press this button when you want to check the channel being received, the picture source, if the channel has stereo (ST) or second audio program (SAP), the time, CHANNEL ID and if the SLEEP timer is set.

THE REMOTE CONTROL

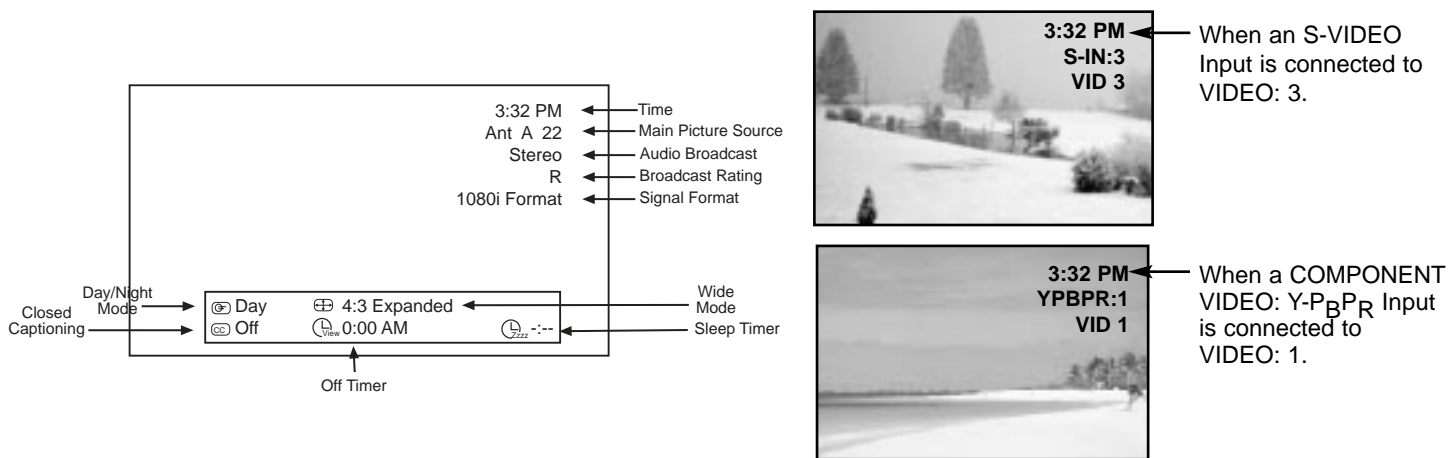

## 11 ANTENNA button

The ANT button will select between Antenna A and Antenna B each time the button is pressed.

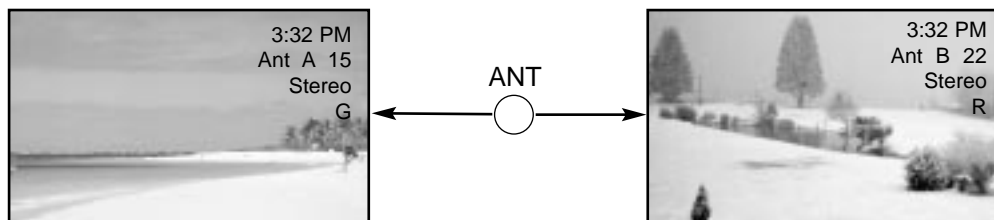

## 12 TV/RGB button

Press this button to toggle between RGB (Analog) mode and TV mode.

# HOW TO USE THE REMOTE TO CONTROL YOUR PLASMA TV



## 13 AV NET button

Press this button to access the Audio/Video network (AV Net) menu. The AV Net allows the user to control external components with the Plasma TV's remote control. When you press the AV NET button, the following window will pop up within the Display Monitor screen. The window will disappear after 30 seconds if you don't press any buttons.

The AV Net Setup Wizard will automatically start upon the very first use. (see page 19-21).

THUMBSTICK ▲ or ▼ to highlight the equipment you wish to control or setup and then press THUMBSTICK ►.

Use THUMBSTICK ▲, ▼, ◀, ▶ to navigate and SELECT to select button. The command on the button is passed through the IR mouse and onto the AUDIO/VIDEO equipment. These on-screen buttons are called "Soft Keys".

Customize your Audio/Video equipment list and soft keys by selecting the "Custom" icon and following the instructions of the AV NET learning wizard (see page 28).

This window shows the available Audio/Video equipment soft keys. The equipment list will scroll up or down.

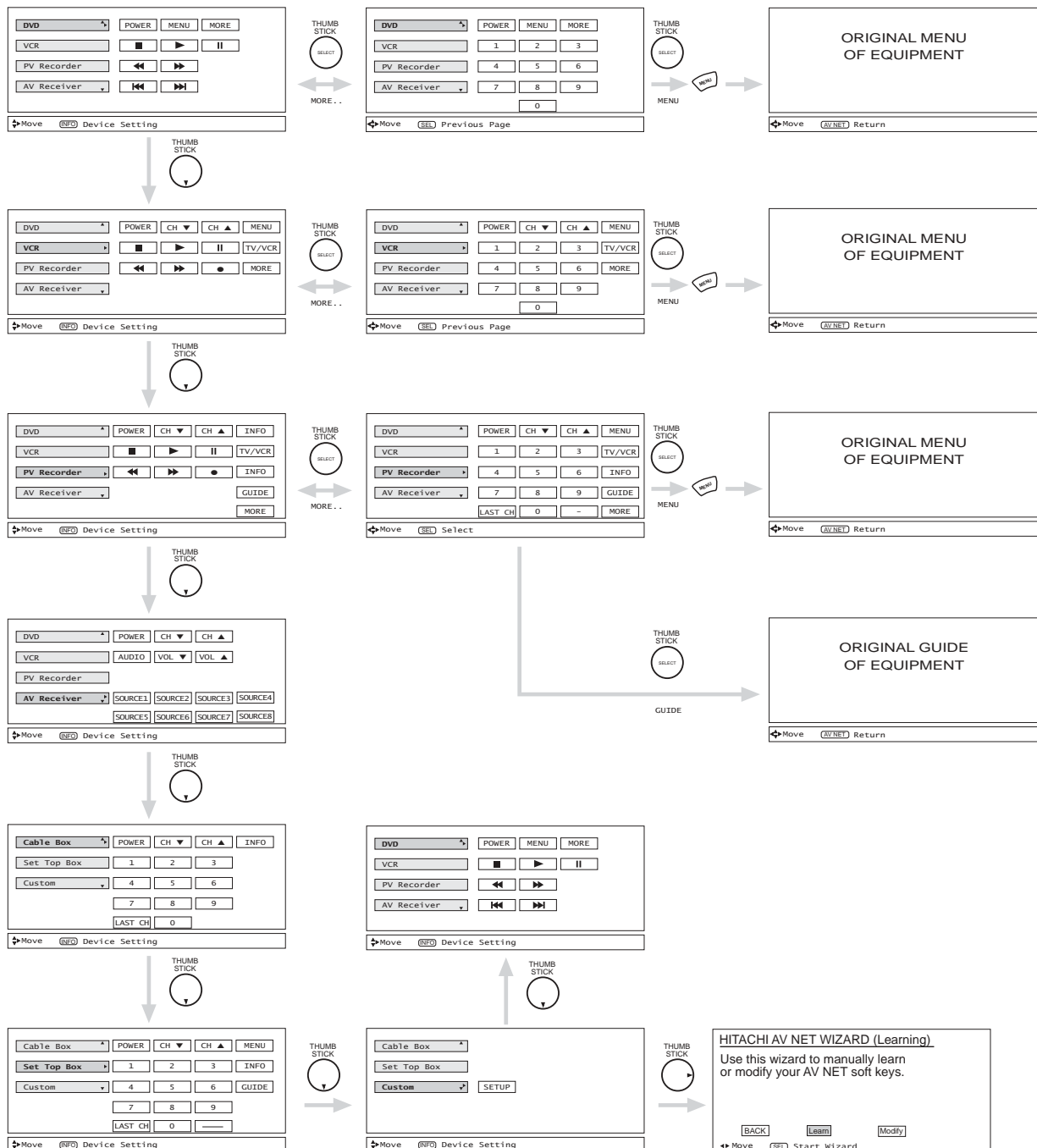

THE REMOTE CONTROL

**NOTE:** To access the cursor function of a specific equipment (Ex. DVD), select the "MENU" soft key on OSD, and press the MENU button of the Plasma TV remote control. Then THUMBSTICK and EXIT button of the Plasma TV remote control is available to control the cursor of the equipment.



# HOW TO USE THE REMOTE TO CONTROL YOUR PLASMA TV



## 14 ASPECT button

Press this button to quickly change the picture format ASPECT ratio.

Depending on the input signal, the picture format ratio allows you to adjust the images through the following options.

- 4:3 Standard Use this aspect mode to display conventional (4:3) images. Side panels (gray areas) are placed to the left and right of the image to preserve the original aspect ratio of the source. Note: Use this mode for only 15% of your total viewing time to prevent uneven aging of the phosphors. Phosphors in the lighted area of the picture will age more rapidly than the black areas.
- 4:3 Expanded use this aspect mode to display conventional (4:3) sources by expanding the outer edges of the image to fill the 16:9 screen. The center of the image remains unaltered.
- 4:3 Zoom1/Zoom2 Use these aspect modes to zoom in on conventional (4:3) sources.
- 16:9 Standard Use this aspect mode to display 16:9 sources like HDTV and DVD's preserving the original 16:9 aspect ratio.
- 16:9 Zoom Use this aspect mode to zoom 16:9 images.

### (1) NTSC/480i/480p Input

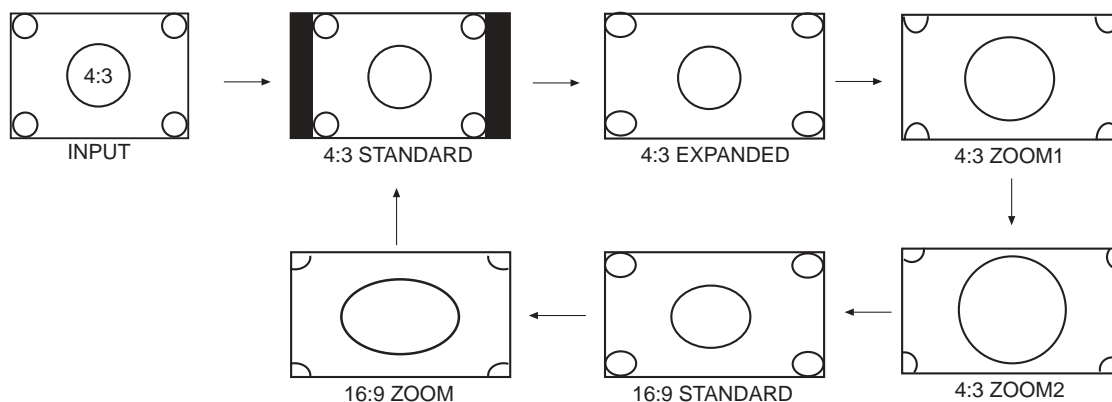

### (2) 480i/480p INPUT

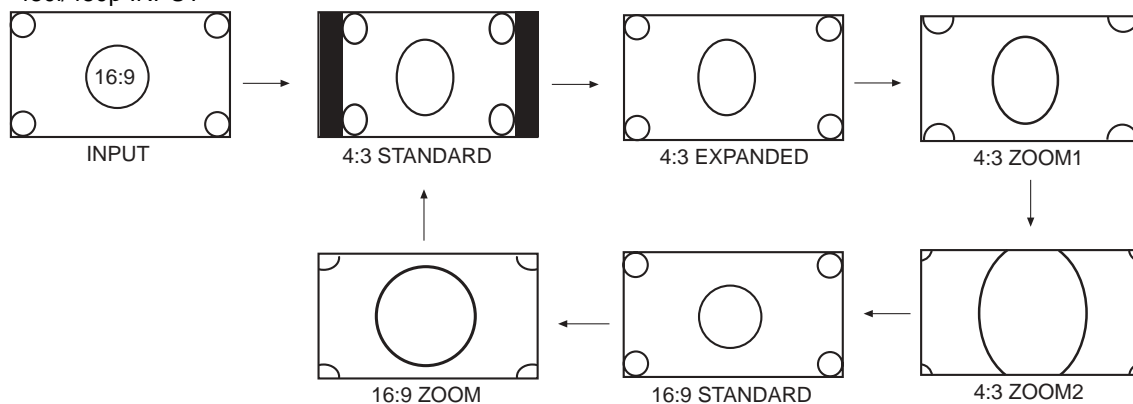

### (3) 720p/1080i INPUT

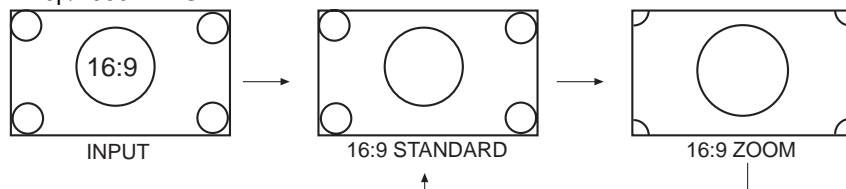

**NOTE:** The Aspect Style setting you select for an ANT input will automatically be set for the other ANT inputs. However, all five video inputs have independent Aspect Style settings.

THE REMOTE CONTROL



# HOW TO USE THE REMOTE TO CONTROL YOUR PLASMA TV

## (4) RGB (Analog Input) ASPECT DISPLAY MODE.

RGB (Analog) INPUT SIGNAL						
ASPECT MODE	Others	SVGA/XGA(4)	VGA	480p	720p	1080i
		X	REAL	REAL	REAL(1)	X
AVAILABILITY	NORMAL	NORMAL	NORMAL	NORMAL(1)	X	X
	FULL	FULL	FULL	FULL(1)	FULL(2,3)	FULL(2,3)

For numbers in ( ), please see corresponding note below.

- NOTES:**
1. Lack of raster can be seen in RGB (Analog) when a 480p signal is input.
  2. AUTO ADJUST function (see page 73) is not available in 720p and 1080i input signal.
  3. FULL aspect mode, only 95% of information can be displayed (5% is treated as overscan).
  4. 50" Only.

THE REMOTE CONTROL

### 15 VIDEO button

Press this button to directly access the VIDEO adjustment menu.

### 16 MENU button

The MENU button will start the On-Screen Display.

### 17 EXIT button

When in MENU mode, this button will exit all On-Screen Displays.

### 18 THUMB STICK/SELECT button

All the On-Screen Display features can be set or adjusted by using the THUMB STICK (Except for numeric entries). The THUMB STICK will highlight functions or adjust and set different features. Press the THUMB STICK toward desired direction and press down to SELECT.

When no on-screen displays are on the TV screen, use THUMB STICK ◀ or ▶ to access the Favorite Channels feature.

To add channels to Favorite Channels, use the number keys to enter the channel number. Use THUMB STICK ▶ to highlight "Add", then press SELECT to store the channel to the Favorite Channel feature. A maximum of 14 channels can be registered to memory. When registering more than 14 channels, the oldest registered channel will be the first to be deleted.

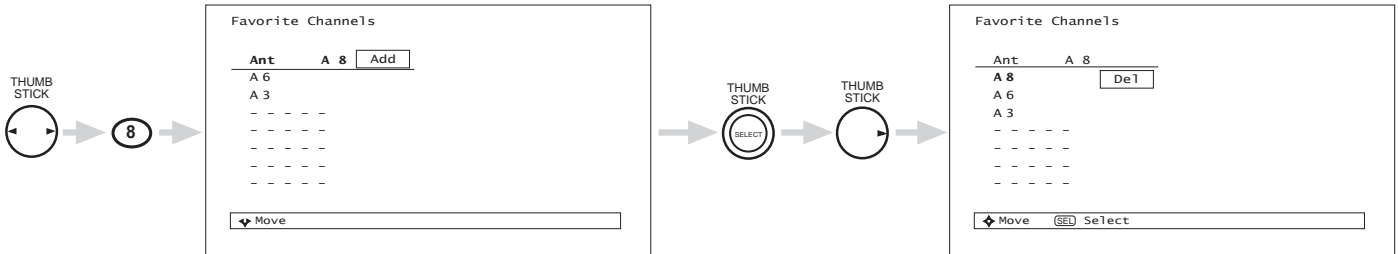

To delete (Del) the channel from the Favorite Channel, use THUMB STICK ▲ , ▼ to highlight the channel, then THUMB STICK ▶ to highlight Delete (Del) and press SELECT to delete.

To view a Favorite Channel use THUMB STICK ▲ , ▼ to highlight the channel and press SELECT to view.

### 19 VOLUME, MUTE button

Press the VOLUME up (▲) or down (▼) button until you obtain the desired sound level.

To reduce the sound to one half of normal volume (SOFT MUTE) to answer the telephone, etc., press the MUTE button. Press the MUTE button again to turn the sound off completely (MUTE). To restore the sound, press the MUTE button one more time, or press the VOLUME Up (▲) button.



Closed Captioning will display when MUTE/SOFT MUTE is on and Closed Caption is set to AUTO (See page 65).



# HOW TO USE THE REMOTE TO CONTROL YOUR PLASMA TV



## 20 LAST CHANNEL (LAST CH) button

Use this button to select between the last two channels viewed (good for watching two sporting events, etc.).

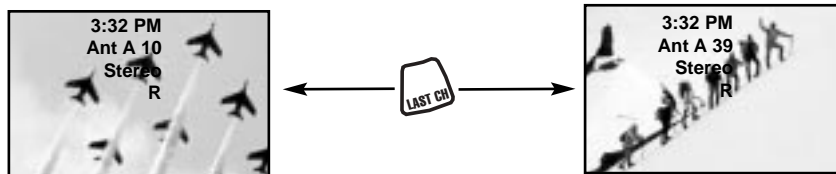

## 21 PICTURE-IN-PICTURE buttons

See separate section on pages 32~34 for a description.

## 22 SURF button

Press the SURF button to automatically scan all active channel numbers (those set in memory) and display them as PIP sub-pictures. Press the SURF button a second time to remove the sub-pictures from the screen.

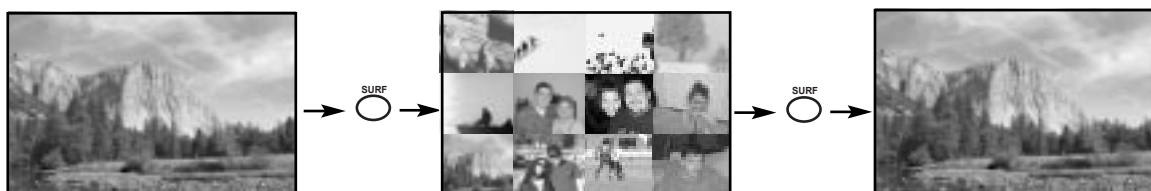

- NOTES:**
1. If no buttons are pressed when in SURF mode, auto-scanning will continuously scan channels in memory (see page 51).
  2. If a channel is changed during this SURF scanning, sub-pictures will be removed from the screen.
  3. If MOVIE/TV RATINGS LOCK setting is ON, PIP SURF mode will be deactivated.
  4. CLOSED CAPTION will not appear when PIP SURF mode is on.
  5. The SURF button will only work in ANT A and ANT B.

## 23 VID1 ~ VID5

When the remote control is in TV mode, press these buttons to directly select the video input sources between the five video inputs.

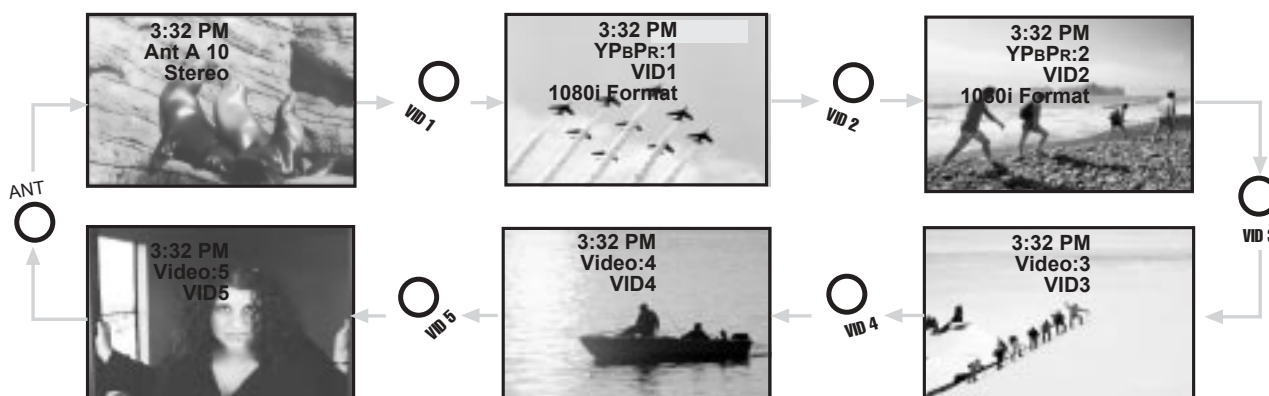

## 24 DAY/NIGHT button

Press this button to toggle between Day and Night picture mode settings. Select Day for day time viewing with more brightness and contrast to compete with room light. Select Night for night time viewing with less brightness and contrast for a more detailed picture.



# PICTURE-IN-PICTURE (PIP)

Your HITACHI Plasma TV incorporates Dual Tuner technology designed for improved viewing enjoyment. This Dual Tuner feature allows you to view antenna inputs on both the main picture and sub-picture simultaneously, with separate tuning control for each. The Dual Tuner can operate with only one input (ANT A only) or two inputs (ANT A and ANT B).

ANT A input can be viewed as both the main picture and the sub-picture simultaneously. ANT B can only be viewed as a main picture. To select between main picture and PIP sub-picture tuning, press the SWAP button on the remote. The highlighted channel display will move with every press of the SWAP button. When the top channel display is highlighted, channel tuning is for the main picture. When the lower channel display is highlighted, channel tuning is for the PIP sub-picture.

The Picture-in-Picture feature is convenient when you want to watch more than one program at the same time. You can watch a TV program while viewing other programs from the ANT A source or any of the video inputs.

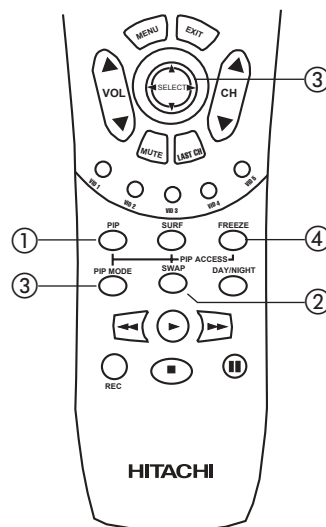
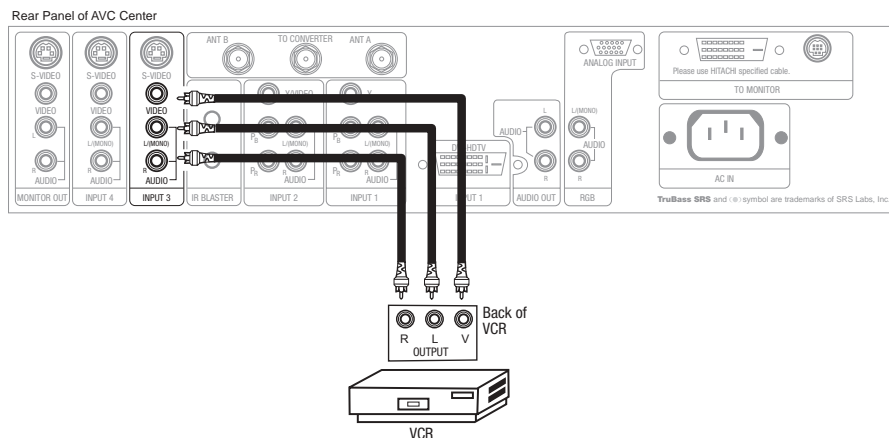

THE REMOTE CONTROL

Use above connection to view VCR program as a sub-picture while viewing another program as main picture (ANT A, ANT B, V:1 V:2, V:4, or V:5). You may also view the VCR program as a main picture while viewing another program as a sub-picture (ANT A, V:1 V:2, V:4, or V:5).

## ① PIP button

Press the PIP button and a sub-picture will appear in one of the available modes (SPLIT, POP or PIP), depending on the last selection of the PIP mode. To change the PIP mode, use the PIP MODE button to cycle through the available modes.

**NOTE:** Using the Picture-in-Picture feature can cause damage and leave a permanent ghost image (screen burns) on the picture if left for long periods of time. It is recommended to use the PIP feature on only 15% of your total viewing time.

## SPLIT MODE PIP

Press the PIP button and a sub-picture appears in one of the available modes (SPLIT, POP or PIP), depending on the last selection of the PIP mode. Press the PIP button again to remove the sub-picture from the screen. Use the SWAP button to select between main and sub-picture tuning control (indicated by green highlighted border around the picture). Press the VID1, VID2, VID3, VID4 or VID5 button when sub-picture channel tuning is being controlled, to change between VIDEO 1 to VIDEO 5 and ANT:A source. (ANT B source cannot be viewed as a sub-picture.)

Split mode PIP displays the main picture and sub-picture evenly on the screen.



- NOTES:**
1. PIP picture quality is not as good as the Main picture quality.
  2. Sound from the Main or Sub-picture can be chosen by using the SWAP button. The Audio will be heard from the picture with the green border.



# PICTURE-IN-PICTURE (PIP)

## POP MODE PIP

This feature displays a sub-picture outside of the main picture. Press the PIP button a second time to remove the sub-pictures from the screen.



## PIP MODE PIP

This feature is only available with a 1080i input signal (Component and DVI-HDTV).

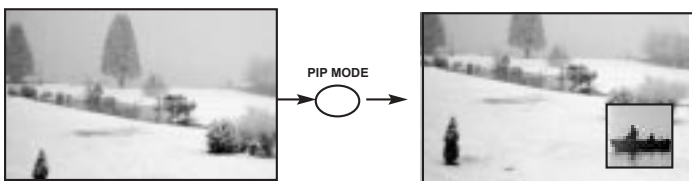

## ② SWAP button (with PIP ON)

Press this button to toggle between the Main and Sub picture which is highlighted with a green border around the picture. Picture sound and channel can be controlled when it is highlighted.

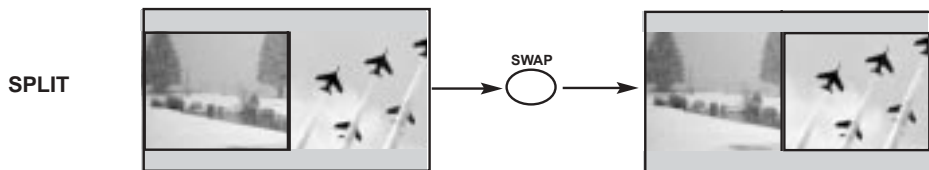

## ③ PIP MODE button

To change between the available PIP modes (moving picture - SPLIT, POP or PIP; freeze picture - SPLIT, STROBE, MAIN and SUB) press the PIP MODE button when PIP is ON. Each press of this button will change PIP to a different mode. Pressing this button two times will cycle through both PIP modes.

### a) Moving Picture

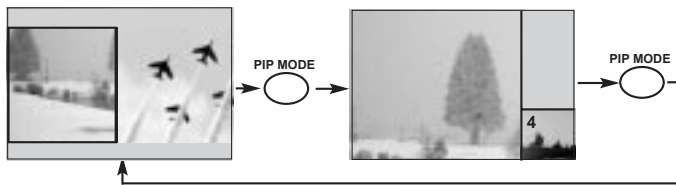

### PICTURE-IN-PICTURE (PIP) MODES

	POP	PIP	SPLIT
NTSC (ANT A/B)	YES	x	YES
480i	YES	x	YES
480p	x	x	YES
720p	x	x	YES
1080i	x	YES	YES

**NOTE:** PIP modes will depend on the type of signal format received.

### b) Freeze Picture

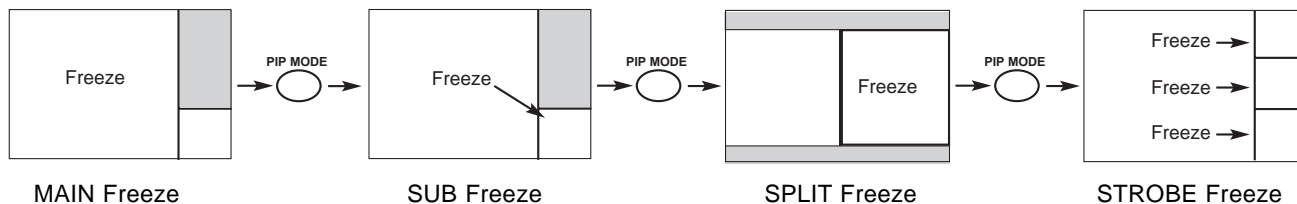

THE REMOTE CONTROL



# PICTURE-IN-PICTURE (PIP)

## ④ FREEZE button (With PIP OFF)

Press the FREEZE button to freeze the picture, depending on the PIP mode selected (SPLIT, STROBE, MAIN and SUB). This is convenient when trying to write down the address for a mail order company, recording statistics for a sporting event, etc. To return the picture to motion, press the FREEZE button again.

To change FREEZE modes, use the PIP MODE button to cycle through the four modes.

### SPLIT FREEZE(with PIP off)

PIP FREEZE should be in SPLIT mode. Press the FREEZE button to freeze the picture you are currently viewing (only the right sub-picture will freeze). Press this button again or PIP to return to normal viewing.

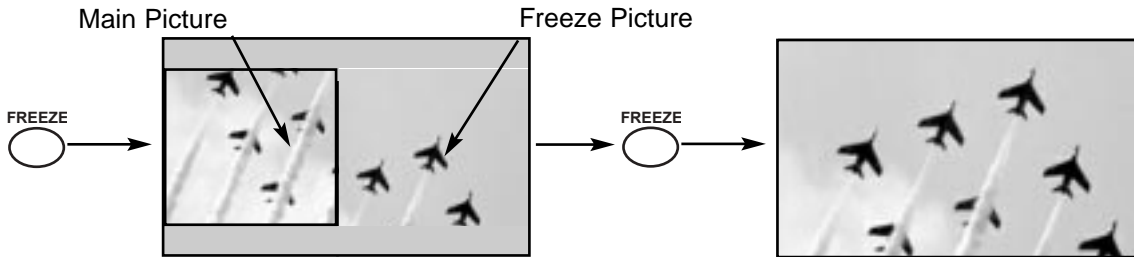

### STROBE FREEZE(with PIP OFF)

PIP FREEZE should be in STROBE mode. Press the FREEZE button to freeze three frames of the picture you are currently viewing. Press this button again or PIP to return to normal viewing. This feature is useful for viewing a moving picture that has many details, for example, a close play in a sporting event or a golf swing.

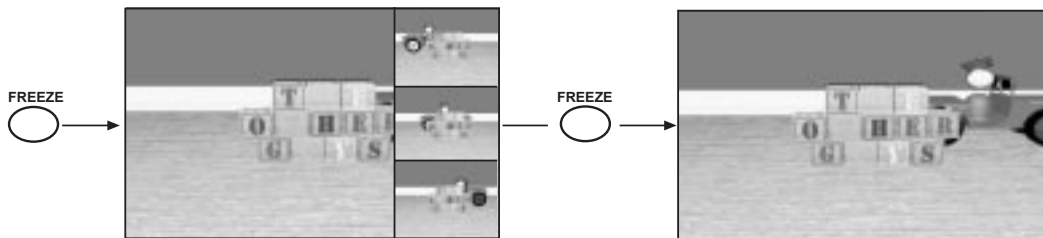

**NOTE:** Each freeze frame is delayed about 0.1 (1/10) second.

### POP MAIN FREEZE (with PIP OFF)

PIP FREEZE should be in POP Main mode. Press the FREEZE button to freeze one frame of the picture you are currently viewing and the frozen frame will show in the Main Picture. Press this button again or PIP to return to normal viewing. This feature is useful for freezing a picture frame with addresses.



### POP SUB FREEZE (with PIP OFF)

PIP FREEZE should be in POP Sub mode. Press the FREEZE button to freeze the sub-picture. Press the FREEZE button again or the PIP button to return to normal viewing.



**NOTE:** For 50" only, brightness will decrease automatically during Freeze Framed or non-moving pictures. This is not a failure. It is a special feature to avoid image retention.

# USING THE REMOTE TO CONTROL VCR FUNCTIONS



## Operating the precoded function for your VCR.

This remote is designed to operate different types of VCRs. You must first program the remote to match the remote command set of your VCR (refer to page 41 for pre-codes).

1. Turn ON your VCR.
2. Aim the remote control at the front of your VCR.
3. Press and release the VCR button to switch to VCR pre-coded mode.
4. Hold down the VCR button on the remote and enter the two digit preset code that matches your VCR, as shown on page 41. The VCR button light will flash 3 times if the code was accepted.
5. Aim the remote at the VCR and press the POWER button. The remote will turn off your VCR if the correct two digit preset code is entered. When this occurs, the remote control is programmed for your VCR. If the VCR does not turn off, try a different two digit preset code.
6. The remote will now control your VCR.

### NOTES:

1. If your VCR cannot be operated after performing the above procedures, your VCR's code has not been precoded into the remote.
2. In the unlikely event that your VCR cannot be operated after performing the above procedures, please consult your VCR operating guide.
3. The remote control will remember the codes you have programmed until the batteries are removed from the remote control. After replacing the batteries repeat the entire programming procedure as stated above.
4. The MENU button will act as the VCR MENU button for HITACHI VCRs.
5. The LAST CH button will act as your VCR ENTER button if required.
6. The SLEEP button will act as your VCR '100' button if required.

### ① VCR Button

This button allows the remote to control your VCR by setting it to VCR mode.

### ② PRECODED VCR Buttons

These buttons transmit the chosen precoded VCR codes. For some VCRs, you must press the RECORD button twice to record a program.

### ③ EXCLUSIVE TV Buttons

These buttons are for operating the TV.

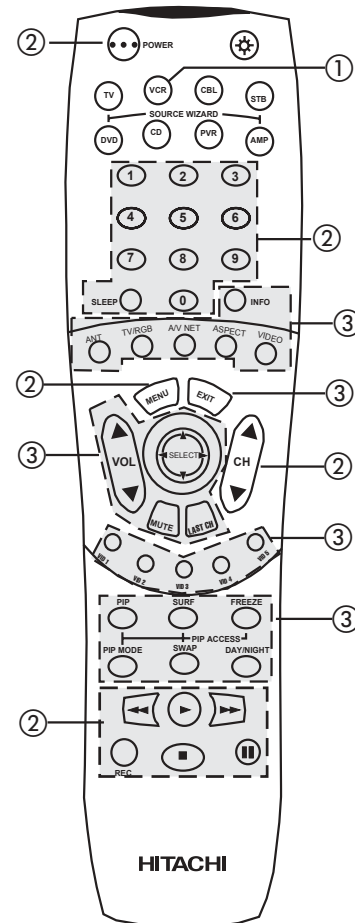

THE REMOTE CONTROL

MY VCR CODE IS: \_\_\_\_\_

**NOTE:** Refer to instruction manual of the VCR for operation of the buttons exclusively for the VCR.



# USING THE REMOTE TO CONTROL CABLE BOX FUNCTIONS

## Operating the precoded function for your cable box.

This remote is designed to operate different types of cable boxes. You must first program the remote to match the remote command set of your cable box (refer to page 41).

1. Turn ON your cable box.
2. Aim the remote control at the front of your cable box.
3. Press and release the Cable (CBL) button to switch to Cable pre-coded mode.
4. Hold down the CBL button on the remote and enter the two digit preset code that matches your cable box as shown on page 41. The CBL button light will flash 3 times if the code was accepted.
5. Aim the remote at the cable box and press the POWER button. The remote will turn off your cable box if the correct two digit preset code is entered. When this occurs, the remote control is programmed for your cable box. If the cable box does not turn off, try a different two digit preset code.
6. The remote will now control your Cable box.

### NOTES:

1. If your cable box cannot be operated after performing the above procedures, your cable box code has not been precoded into the remote.
2. In the unlikely event that your cable box cannot be operated after performing the above procedures, please consult your cable box operating guide.
3. The remote control will remember the codes you have programmed until the batteries are removed from the remote control. After replacing the batteries repeat the entire programming procedure as stated above.
4. The LAST CH button will act as the cable box ENTER button if required.
5. The SLEEP button will act as your cable box '100' button if required.
6. The ANT button will act as the TV/STB button when in STB mode.

THE REMOTE CONTROL

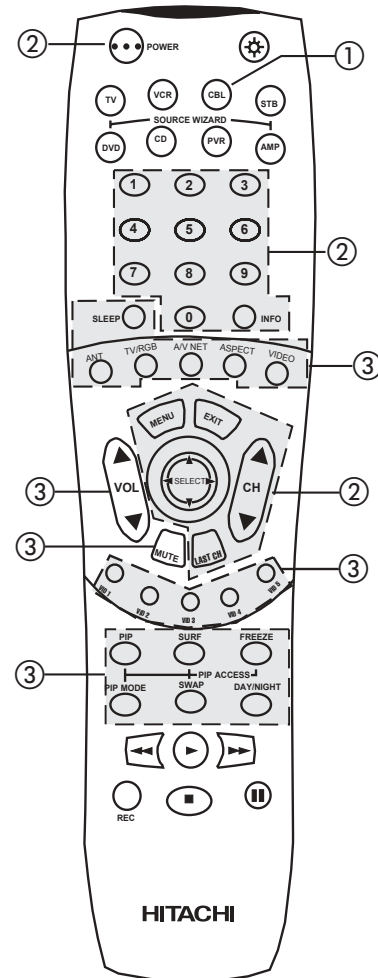

- ① **CABLE (CBL) button**  
This button allows the remote to control your cable box by setting it to CABLE mode.
- ② **PRECODED CABLE BOX buttons**  
These buttons transmit the chosen precoded cable codes.
- ③ **EXCLUSIVE TV buttons**  
These buttons are for operating the TV.

MY CABLE BOX CODE IS: \_\_\_\_\_

**NOTE:** Refer to instruction manual of the Cable Box for operation of the buttons exclusively for the Cable Box.



# USING THE REMOTE TO CONTROL SET-TOP-BOX/SATELLITE RECEIVER FUNCTIONS



## Operating the precoded function for your set-top-box/satellite receiver.

This remote is designed to operate different types of set-top-box/satellite systems. You must first program the remote to match the remote command set of your set-top-box/satellite systems (refer to page 41).

1. Turn ON your set-top-box/satellite systems.
2. Aim the remote control at the front of your set-top-box/satellite systems.
3. Press and release the SET-TOP-BOX (STB) button to switch to set-top-box/satellite pre-coded mode.
4. Hold down the STB button on the remote and enter the two digit preset code that matches your set-top-box/satellite receiver as shown on page 41. The STB button light will flash 3 times if the code was accepted.
5. Aim the remote at the set-top-box/satellite receiver and press the POWER button. The remote will turn off your set-top-box/satellite receiver if the correct two digit preset code is entered. When this occurs, the remote control is programmed for your set-top-box/satellite receiver. If the set-top-box/satellite receiver does not turn off, try a different two digit preset code.
6. The remote will now control your set-top-box/satellite receiver.

### NOTES:

1. If your set-top-box/satellite receiver cannot be operated after performing the above procedures, your set-top-box/satellite receiver code has not been precoded into the remote.
2. In the unlikely event that your set-top-box/satellite receiver cannot be operated after performing the above procedures, please consult your set-top-box/satellite receiver operating guide.
3. The remote control will remember the codes you have programmed until the batteries are removed from the remote control. After replacing the batteries repeat the entire programming procedure as stated above.
4. The ANT button will act as the TV/STB button when in STB mode.

- ① **SET-TOP-BOX (STB) button**  
This button allows the remote to control your satellite receiver by setting it to SET-TOP-BOX/SATELLITE mode.
- ② **PRECODED SET-TOP-BOX/SATELLITE RECEIVER buttons**  
These buttons transmit the chosen precoded set-top-box/satellite codes.
- ③ **EXCLUSIVE TV buttons**  
These buttons are for operating the TV.

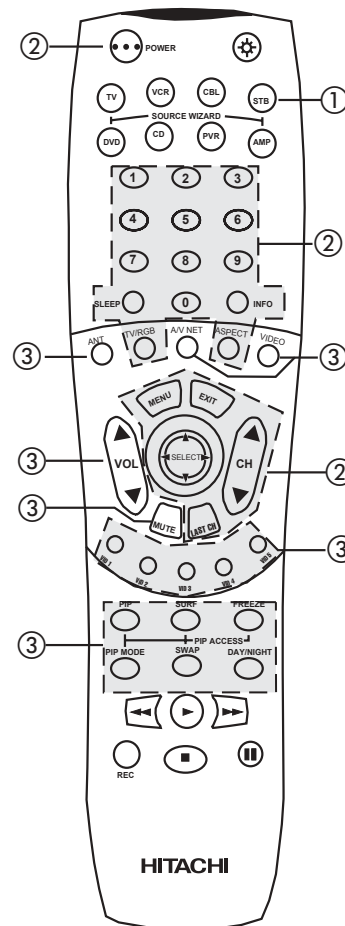

THE REMOTE CONTROL

**MY SATELLITE RECEIVER/STB CODE IS: \_\_\_\_\_**

**NOTE:** Refer to instruction manual of the set-top-box/satellite receiver for operation of the buttons exclusively for the set-top-box/satellite receiver.





# USING THE REMOTE TO CONTROL DVD FUNCTIONS

## Operating the precoded function for your DVD player.

This remote is designed to operate different types of DVD players. You must first program the remote to match the remote command set of your DVD player (refer to page 41 for pre-codes).

1. Turn ON your DVD player.
2. Aim the remote control at the front of your DVD player.
3. Press and release the DVD button to switch to DVD pre-coded mode.
4. Hold down the DVD button on the remote and enter the two digit preset code that matches your DVD player, as shown on page 41. The DVD button light will flash 3 times if the code was accepted.
5. Aim the remote at the DVD player and press the POWER button. The remote will turn off your DVD player if the correct two digit preset code is entered. When this occurs, the remote control is programmed for your DVD player. If the DVD player does not turn off, try a different two digit preset code.
6. The remote will now control your DVD player.
7. You will need to set the Display Type of your DVD player to 16:9 Widescreen.

THE REMOTE CONTROL

### NOTES:

1. If your DVD player cannot be operated after performing the above procedures, your DVD player's code has not been precoded into the remote.
2. In the unlikely event that your DVD player cannot be operated after performing the above procedures, please consult your DVD player operating guide.
3. The remote control will remember the codes you have programmed until the batteries are removed from the remote control. After replacing the batteries repeat the entire programming procedure as stated above.

- ① **DVD Button**  
This button allows the remote to control your DVD player by setting it to DVD mode.
- ② **PRECODED DVD Buttons**  
These buttons transmit the chosen precoded DVD codes.
- ③ **EXCLUSIVE TV Buttons**  
These buttons are for operating the TV.

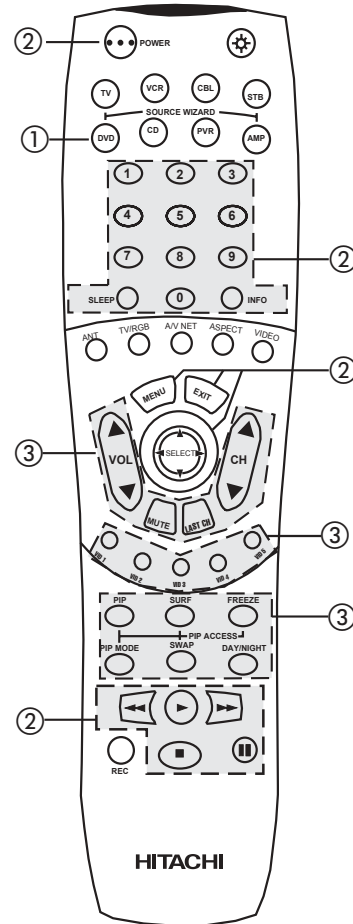

MY DVD PLAYER CODE IS: \_\_\_\_\_

**NOTE:** Refer to instruction manual of the DVD player for operation of the buttons exclusively for the DVD player.

# USING YOUR REMOTE TO CONTROL ADDITIONAL AUDIO EQUIPMENT AND PVR



## Operating the precoded function for your Audio component.

This remote is designed to operate different types of Audio component. You must first program the remote to match the remote command set of your Audio component (refer to page 41 for pre-codes).

1. Turn ON your Audio component you wish to control with the Remote.
2. Aim the remote control at the front of your Audio component.
3. Press and release the CD, PVR, or AMP button to switch to Audio component pre-coded mode.
4. Hold down the CD, PVR, or AMP button on the remote and enter the two digit preset code that matches your Audio component, as shown on page 41. The CD, PVR or AMP button light will flash 3 times if the code was accepted.
5. Aim the remote at the Audio component and press the POWER button. The remote will turn off your Audio component if the correct two digit preset code is entered. When this occurs, the remote control is programmed for your Audio component. If the Audio component does not turn off, try a different two digit preset code.
6. The remote will now control your Audio component.
7. Repeat steps 1 - 6 if you wish to program the remote to control another Audio component. Be sure to use a different Audio button on the remote, since only one component can be programmed per button.

### NOTES:

1. If your Audio component cannot be operated after performing the above procedures, your Audio component's code has not been precoded into the remote.
2. In the unlikely event that your Audio component cannot be operated after performing the above procedures, please consult your Audio equipment operating guide.
3. The remote control will remember the codes you have programmed until the batteries are removed from the remote control. After replacing the batteries repeat the entire programming procedure as stated above.

- ① **CD, PVR, AMP Buttons**  
These buttons allow the remote to control your Audio equipment by setting it to Audio mode.
- ② **PRECODED AUDIO Buttons**  
These buttons transmit the chosen precoded Audio component codes.
- ③ **PRECODED PVR Buttons**  
These buttons transmit the chosen precoded PVR codes.
- ④ **EXCLUSIVE TV Buttons**  
These buttons are for operating the Plasma TV.

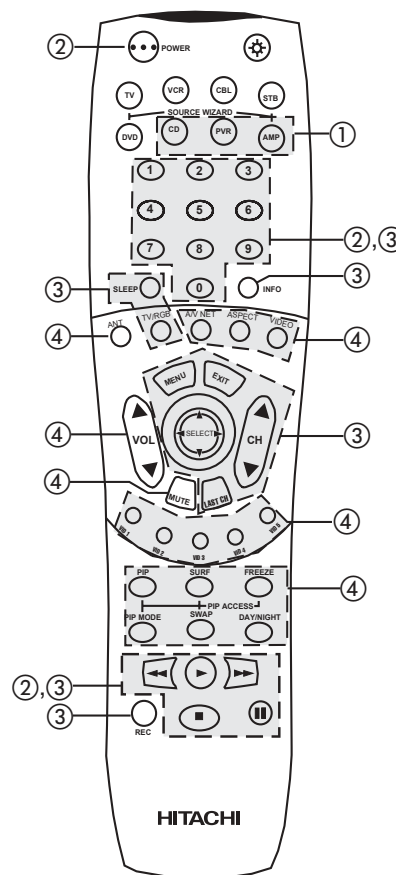

THE REMOTE CONTROL

**MY PVR CODE IS:**

PVR \_\_\_\_\_

**MY AUDIO EQUIPMENT CODE IS:**

CD \_\_\_\_\_  
AMP/RCVR \_\_\_\_\_

**NOTE:** Refer to instruction manual of the Audio equipment for operation of the buttons exclusively for the Audio equipment.



# THE SIMPLE REMOTE CONTROL

HITACHI has provided a second remote control for your convenience. The Simple Remote Control has the basic features that are most often used.

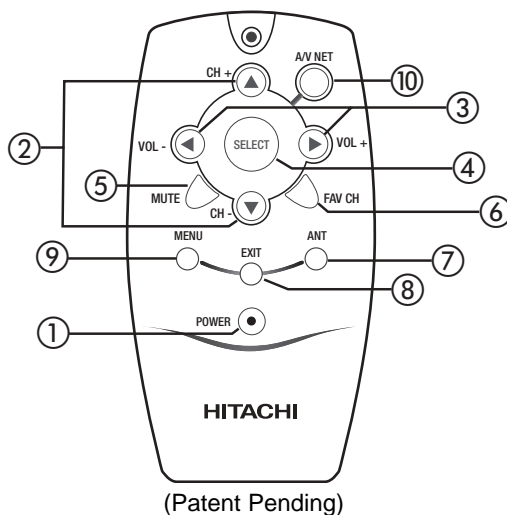

## THE REMOTE CONTROL

- (Patent Pending)
- ① **POWER button**  
Press Power button to turn the Plasma TV ON or OFF.
  - ② **CH+ (▲), CH- (▼)**  
Press the CH+ (▲) up or CH- (▼) down buttons to select desired channel or to navigate the on screen display features when in AV NET mode.
  - ③ **VOL- (◀), VOL+ (▶)**  
Press the VOL- (◀) down or VOL+ (▶) up buttons to select desired sound level or to navigate the on screen display features when in AV NET mode.
  - ④ **SELECT button**  
Press SELECT button to Select when in MENU and AV NET mode.
  - ⑤ **MUTE button**  
To reduce the sound to one half of normal volume (SOFT MUTE) to answer the telephone, etc., press the MUTE button. Press the MUTE button again to turn the sound off completely (MUTE). To restore the sound, press the MUTE button one more time, or press the VOLUME Up (▶) button. (See complete explanation and example on page 30, Item ⑩.)
  - ⑥ **FAV CH button**  
Press FAV CH button to access your favorite channels.
  - ⑦ **ANT button**  
The ANT button will select between Antenna A and Antenna B each time the button is pressed. (See example on page 26, item ⑩.)
  - ⑧ **EXIT button**  
When in MENU mode, this button will exit all On-Screen Displays.
  - ⑨ **MENU button**  
Press the MENU button to start the On-Screen Display.
  - ⑩ **AV NET**  
Press this button to access the Audio/Video network (AV Net) menu. The AV Net allows the user to control external components with the TV's remote control. (See complete explanation and example on page 27, item ⑬.)

**NOTE:** The Simple Remote cannot be programmed to control external components.

# AUDIO/VIDEO CODES FOR REMOTE CONTROL ONLY



VCR BRAND.....	CODE
Adventura .....	01
Aiko .....	09
Aiwa .....	01
Akai .....	02, 47, 48
American High.....	23
Asha .....	44
Audiovox .....	24
Beaumarck .....	44
Bell & Howell.....	32
Broksonic.....	33, 34, 41
Calix .....	24
Canon .....	23
Carver .....	31
CCE .....	09
Citizen .....	09, 24
Craig .....	19, 24, 44
Curtis Mathes .....	02, 23, 46
Cybernex .....	44
Daewoo .....	09, 17
Dynatech .....	01
Electrohome .....	24
Electroponic.....	24
Emerex .....	08
Emerson .....	01, 09, 13, 16, 24, 27, 28, 33, 34, 36, 41, 47
Fisher .....	19, 21, 32
Fuji .....	10, 23
Funai .....	01
Garrard .....	01
GE .....	04, 23, 40, 46
Goldstar .....	24, 25, 43
Gradiente .....	01
Harley Davidson .....	01
Harmon/Kardon .....	25
Headquarter .....	18
Hi-Q .....	19
Hitachi .....	01, 02, 03, 04, 05
Jensen .....	02
JVC .....	02, 14, 26
KEC .....	09, 24
Kenwood .....	02, 25, 26
KLH .....	30
Kodak .....	23, 24
Lloyd .....	01
Lloyd's .....	27
LXI .....	24
Magnavox .....	15, 23, 31, 35
Magnin .....	44
Marantz .....	23, 31
Marta .....	24
Matsushita .....	23
MEI .....	23
Memorex .....	01, 15, 18, 19, 20, 23, 24, 32, 44
MGA .....	16, 47
MGN Technology .....	44
Minolta .....	03, 05
Mitsubishi .....	16, 26, 39, 47, 48
Motorola .....	20, 23
MTC .....	01, 44
Multitech .....	01
NEC .....	02, 25, 26, 32
Nikko .....	24
Noblex .....	44
Olympus .....	12, 23
Optimus .....	20, 24, 32
Panasonic .....	11, 12, 23, 38
Penney .....	03, 23, 24, 25, 44
Pentax .....	03, 04, 05
Philco .....	23
Phillips .....	23, 31
Pilot .....	24
Pioneer .....	26
Pulsar .....	15

Quarter .....	18
Quartz .....	18
Quasar .....	23
Radio Shack .....	01, 24
Radix .....	24
Randex .....	24
RCA .....	03, 04, 05, 35, 40, 46
Realistic .....	01, 18, 19, 20, 21, 23, 24, 32, 44
Ricoh .....	22
Runco .....	15
Samsung .....	17, 44
Sanky .....	15, 20
Sansui .....	02, 26
Sanyo .....	18, 19, 32, 44
Scott .....	16, 17, 33, 34, 36, 41
Sears .....	03, 05, 18, 19, 21, 23, 24, 32
Sharp .....	20
Shintom .....	30
Shogun .....	44
Sony .....	08, 10, 22, 23
STS .....	03
Sylvania .....	01, 16, 23, 31
Symphonic .....	01
Tatung .....	02
Teac .....	01, 02
Technics .....	23, 38
Teknika .....	01, 23, 24
TMK .....	27, 44
Toshiba .....	16, 17, 21, 36
Totvision .....	24, 44
Unitech .....	44
Vector .....	17
Vector Research .....	25
Video Concepts .....	17, 47
Video sonic .....	44
Wards .....	01, 03, 19, 20, 23, 35, 36, 44, 46
XR-1000 .....	01, 23
Yamaha .....	25
Zenith .....	10, 15, 22

DVD BRAND.....	CODE
APEX .....	15
Denon .....	04
Go Video .....	14
Hitachi .....	07, 12, 13
JVC .....	01
Kenwood .....	04, 16
Magnavox .....	05
Mitsubishi .....	10
Panasonic .....	04
Phillips .....	06
Pioneer .....	03
RCA (Proscan).....	09, 17
Samsung .....	12
Sanyo .....	13
Sony .....	02
Toshiba .....	05
Yamaha .....	08
Zenith .....	05, 11

CABLE BRAND .....	CODE
ABC .....	01, 07, 08, 17, 18, 20, 36, 37, 49
Antronix .....	39
Archer .....	11, 24, 39
Belcor .....	32
Cable Star .....	32
Century .....	11
Citizen .....	11
Colour Voice .....	30, 42
Comtronics .....	25, 28
Contec .....	21

Dae Ryung .....	20
Eastern .....	14
Electricord .....	31
Everquest .....	51
Focus .....	52
Garrard .....	11
GC Electronics.....	32, 39
Gemini .....	05, 38, 43, 51
General Instrument .....	01, 12
Goldstar .....	10, 25
Hamlin .....	04, 13, 22, 23
Hitachi .....	01
Hytex .....	36
Jasco .....	11
Jerrold .....	01, 08, 12, 37, 49, 50, 51
Macom .....	35
Magnavox .....	15
Memorex .....	03
Movie Time .....	29, 31, 33
NSC .....	29, 33, 38
Oak .....	21, 36, 46
Panasonic .....	02, 03, 09
Paragon .....	03
Phillips .....	11, 15, 16, 26, 30, 42, 43, 44
Pioneer .....	06, 10, 19, 55
Popular Mechanics .....	52
Pulsar .....	03
RCA .....	02
Realistic .....	39
Recoton .....	52
Regal .....	04, 22, 34
Regency .....	14
Rembrandt.....	01, 38
Runco .....	03
Samsung .....	10, 25
Scientific Atlanta .....	17, 20, 41, 45, 55
Signal .....	25, 51
Signature .....	01
SL Marx .....	25
Sprucer .....	02
Starcom .....	37, 49, 51
Stargate .....	25, 51
Starquest .....	51
Starsight .....	53, 54
Sylvania .....	18
Televue .....	25
Texscan .....	18
Tocom .....	07, 27, 50
Toshiba .....	03
Tusa .....	51
TV 86 .....	29
Unika .....	11, 39
United Artists .....	36
United Cable .....	49
Universal .....	11, 24, 31, 32, 34, 39
Video way .....	47
Viewstar .....	15, 28, 29, 40
Zenith .....	03, 48
Zentek .....	52

SATELLITE BRAND .....	CODE
Echostar .....	04
Hitachi .....	01
Hughes .....	05
RCA .....	02
Sony .....	03

SET-TOP-BOX .....	CODE
Panasonic .....	06
RCA .....	07
Samsung .....	08
Zenith .....	09

AMPLIFIER BRAND .....	CODE
Aiwa .....	05, 06
Carver .....	01, 06, 08
Denon .....	10
Fisher .....	08, 11
Hitachi .....	12
JVC .....	13
Kenwood .....	14, 15, 17, 18
Magnavox .....	01, 06
Marantz .....	01, 06, 16
MCS .....	16
Optimus .....	03, 04, 11, 15, 20
Panasonic .....	16
Philips .....	01, 06
Pioneer .....	03, 04, 20, 21, 22
Quasar .....	16
Sansui .....	06
Sanyo .....	11
Sharp .....	15
Sony .....	05
Technics .....	02, 16, 23, 24, 25
Victor .....	13
Wards .....	03, 05, 06, 08, 20, 21
Yamaha .....	15, 26

CD BRAND.....	CODE
Adcom .....	01
Aiwa .....	02
California Audio Lab .....	03
Carver .....	02
Denon .....	04
DKK .....	05
Emerson .....	01
Fisher .....	06
Genexxa .....	07
Hitachi .....	01, 07, 08, 09, 10, 11, 12
JVC .....	13
Kenwood .....	06, 14, 15
Krell .....	02
Magnavox .....	02
Marantz .....	02, 03
MCS .....	03
Mission .....	03
NSM .....	02
Onkyo .....	16
Optimus .....	05, 07, 17
Panasonic .....	03
Philips .....	02
Pioneer .....	07, 17
Proton .....	02
QED .....	02
Quasar .....	03
RCA .....	01, 21
Realistic .....	01
Rotel .....	02
SAE .....	02
Sansui .....	02
Scott .....	01
Sony .....	05, 18
Technics .....	03, 19, 20
Victor .....	13

PVR BRAND.....	CODE
Tivo .....	01
Replay .....	02

# OSD (On-Screen Display)

1. Press MENU on the remote control to display the different features on your HITACHI Plasma TV.
2. Use the THUMB STICK to navigate to a different menu item.
3. Press EXIT on the remote control to quickly exit from a menu.
4. Press AV NET on the remote control to access the AV Network menu to control external components.

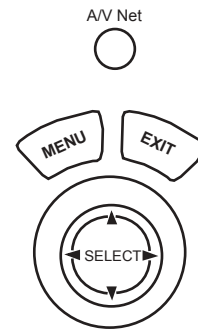

This part of the screen shows which selections are available.

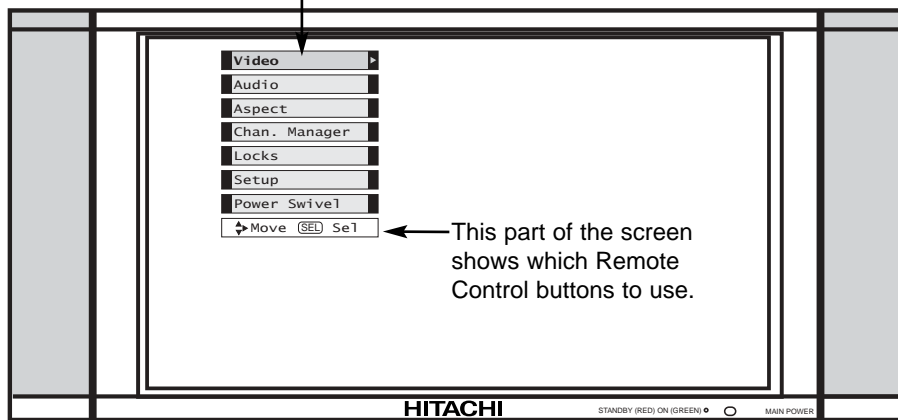

**32"/42" Only**

This part of the screen shows which selections are available.

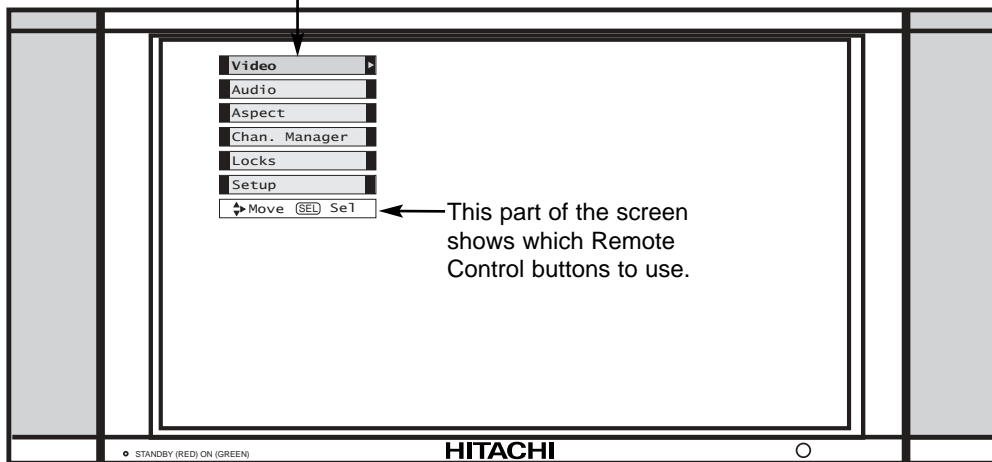

**50" Only**

ON-SCREEN DISPLAY

- NOTES:**
1. The Power Swivel OSD will not be available for the 50" model.
  2. When the Power Swivel connection cable is disconnected, the Power Swivel OSD will disappear.

# OSD (On-Screen Display)

Video	Picture Mode	Select between the two picture modes; Day and Night.
	Contrast	Adjust contrast.
	Brightness	Adjust brightness.
	Color	Adjust color.
	Tint	Adjust tint.
	Sharpness	Adjust sharpness.
	Color Temperature	Set this to High for less intense color with more blue, set to Medium for natural color, set to Standard for standard colors or Black and White for more reddish color.
	Black Enhancement	Adjust shadow detail in dark screens.
	Contrast Mode	Choose Automatic Contrast settings.
	Reset Video Settings	Choose the Reset Video settings.
	Color Management	Adjust and balance individual colors to make either deeper or more pure according to preference.
	Color Decoding	Adjust the percentage of Red, Green and Color according to preference.
	Auto Color	The AUTO COLOR function automatically monitors and adjusts the color to maintain constant color levels even after a program or channel changes. It also maintains natural flesh tones while preserving fidelity of background colors.
Noise Reduction	Reduces conspicuous noise in the picture.	
Auto Movie Mode	Turn ON/OFF the 3:2 Pulldown detection feature.	
Audio	Treble	Adjust the treble.
	Bass	Adjust the bass.
	Balance	Adjust the balance.
	SRS TruBass	Select TruBass and Matrix surround settings.
	Matrix Surround	Improve sound performance.
	Audio Source	Select between three Audio Sources.
	Internal Speakers	Select internal or external speakers.
	Auto Noise Cancel	Eliminates the noise between stations.
	Perfect Volume	Adjust volume in fixed setting.
Aspect	Mode	Choose the picture format aspect ratio.
Chan. Manager	Ant A	View/edit Channel ID, Scan, and Lock settings in antenna A.
	Ant B	View/edit Channel ID, Scan, and Lock settings in antenna B.
Locks	Change Access Code	Change Lock access code.
	Engage Lock	Choose to lock channel, video input, and front panel.
	TV Time Lock	Set specific time to Lock TV.
	Movie Ratings	Block various types of movies and video types based on motion picture ratings.
	TV Ratings parental guide ratings.	Block various types of movies and television programming based on a
	Canadian Ratings (ENG)	Block various types of movies and television programming based on the Canadian ratings system.
Canadian Ratings (FRN)	Block various types of movies and television programming based on the Canadian French ratings system.	
Setup	Menu Preference	Choose English, French, or Spanish text.
	Screen Saver	Set Screen Saver to prevent screen burn.
	Set The Clock	Set the TV clock. It must be set before using the Lock feature.
	Set The Inputs	Label Video Inputs , VCR, DVD, etc.
	Set The Color System	Set tint and color coordinates for DTV programs.
	Set Black Side Panel	Set the gray side bars on/off when watching 4:3 signals in standard mode.
	Set Event Timer	Turn TV on and off once, daily, or weekly.
	Set Closed Captions	Feature to display dialogue/text.
Power Swivel	Power Swivel	Controls the motorized stand for 32"/42" models.

## Video

Select VIDEO to adjust picture settings and improve picture quality. You can customize each of the Video Inputs to your preference to increase viewing performance and pleasure depending upon the video program being viewed. If RESET is selected, only the selected mode will reset to initial conditions.

## Picture Mode

Use this function to choose from automatic picture settings to optimize your TV's performance.

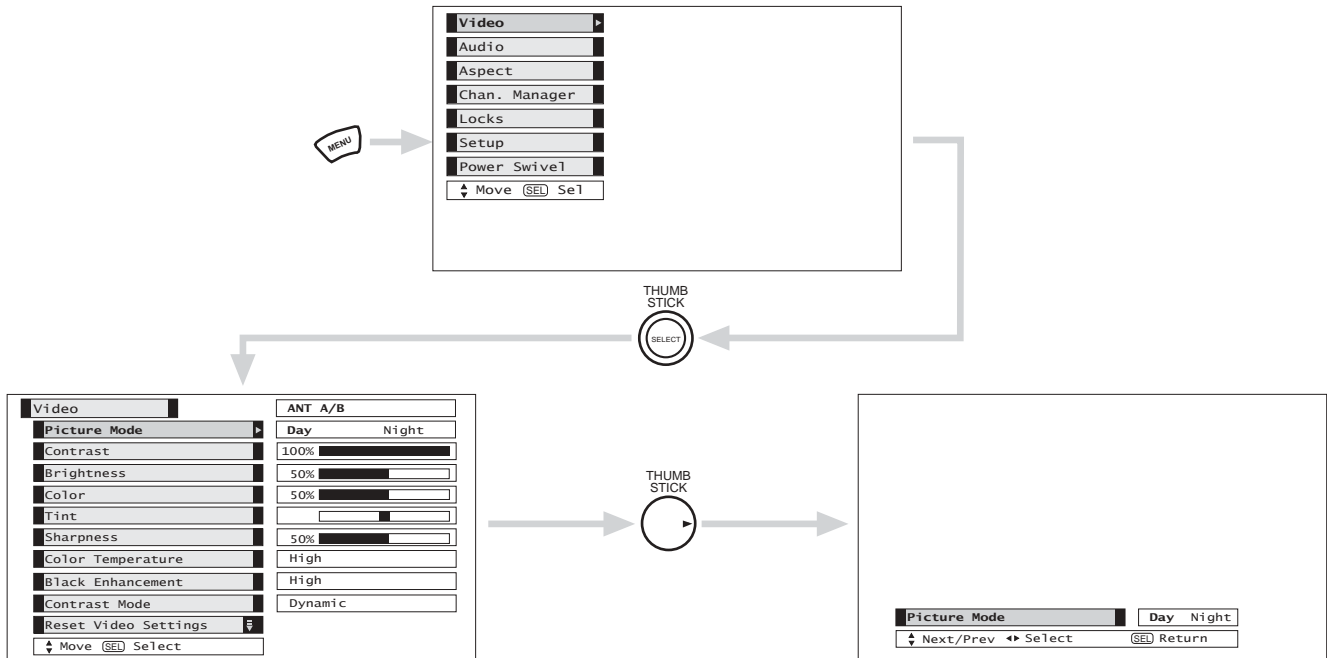

Use THUMB STICK ▲ or ▼ to highlight Picture Mode settings.

Function	Day	Night	Reset
Contrast	100%	91%	Reset the video menu settings on current input to the Day or Night conditions depending on the selected VIDEO mode.
Brightness	50%	60%	
Color	50%	16%	
Tint	50%	58%	
Sharpness	50%	40%	
Color Temperature	High	Standard	
Black Enhancement	Middle	Off	
Contrast Mode	Dynamic	Normal	
Auto Color	Off	Off	
Noise Reduction	Low	Off	
Color Management (Set User Colors)	Off	On	
Auto Movie Mode (TV/Cinema Detection)	Off	On	

Press EXIT to quit menu or select PICTURE MODE to return to previous menu.



# VIDEO

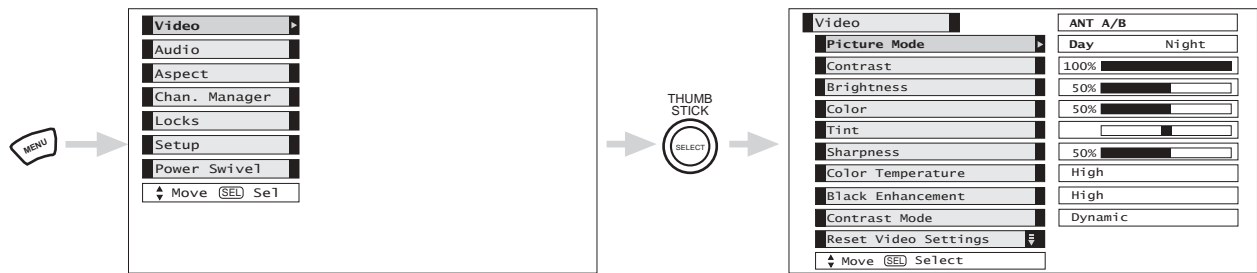

Use the THUMB STICK ▲ or ▼ to highlight the function to be adjusted.  
 Press down on THUMB STICK to select the function settings.  
 Press the THUMB STICK ◀ or ▶ to adjust the function.  
 Press MENU to return to main menu.  
 Press EXIT to quit menu.

- |                          |   |
|--------------------------|---|
| <b>Contrast</b>          | Use this function to change the contrast between black and white levels in the picture. Contrast can be set up to 110% if THUMBSTICK ▶ is pressed and held for 3 seconds. |
| <b>Brightness</b>        | Use this function to adjust overall picture brightness.   |
| <b>Color</b>             | Use this function to adjust the level of color in the picture.  |
| <b>Tint</b>              | Use this function to adjust flesh tones so they appear natural.   |
| <b>Sharpness</b>         | Use this function to adjust the amount of fine detail in the picture.   |
| <b>Color Temperature</b> | Set this to High for cooler color with more blue, set to Medium for more natural color, set to Standard for accurate color or set to Black/White for more reddish color.  |
| <b>Black Enhancement</b> | Use this function to enhance the shadow detail in dark scenes using the settings off, low, middle and high.   |
- NOTES:**

  1. If CONTRAST is selected, you are adjusting CONTRAST. The additional menu items BRIGHTNESS, COLOR, TINT, and SHARPNESS can be selected and adjusted in the same manner.
  2. It may be necessary to adjust TINT to obtain optimum picture quality when using the COMPONENT VIDEO Y-P<sub>B</sub>P<sub>R</sub> input jacks.
- |                      |   |
|----------------------|---|
| <b>Contrast Mode</b> | Use this function to choose between 3 Contrast Mode settings. Set to Dynamic for darker images more in the level of Black, set to Normal for a balanced White to Black level, and set to Auto for automatic Contrast selection. |
|----------------------|---|

## Reset Video Settings

This function allows you to Reset the Video Menu Settings of the present input and return it to the Day or Night conditions depending on the selected VIDEO mode.

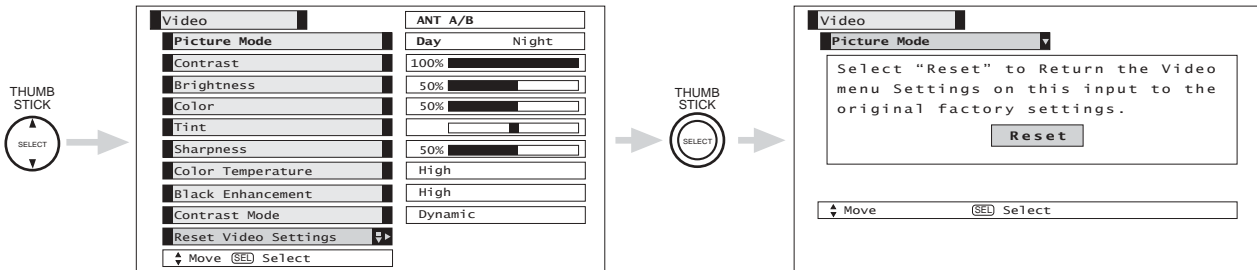

Use THUMB STICK to highlight functions.  
Press down on THUMB STICK to select Reset Video Settings.

Use THUMBSTICK ▼ to access other video settings.

You can customize each of the Video Inputs to your preference to increase viewing performance and pleasure, depending upon the video program being viewed. If RESET is selected, only the selected mode will reset to the initial conditions as explained above.

If RESET is selected in Video:1 mode, only Video:1 mode will return to factory conditions.

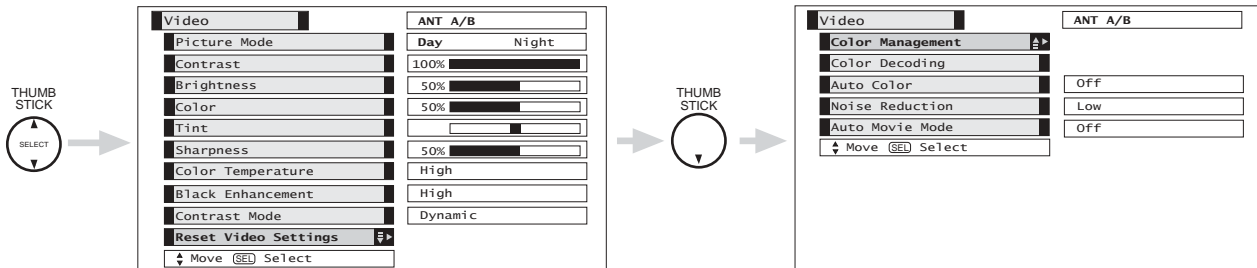

## Color Management

Use this function to adjust and balance the listed individual colors to make them either deeper or more pure depending on the user's preference.

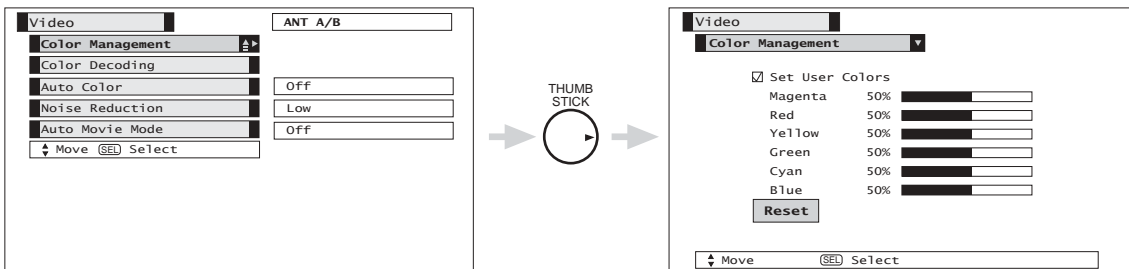

Use THUMBSTICK to highlight function.  
Press down to select the User Colors setting. When the function has a "✓" in the box, it is ON.  
Press THUMBSTICK ◀, ▶, ▼, ▲, to highlight and adjust individual colors.  
Use THUMBSTICK to highlight and select "Reset" to return all colors to default settings.

**NOTE:** When the Set User Colors box is not checked off, the listed colors will be grayed out.

# VIDEO

## Color Decoding

Use this function to adjust the percentage of Red, Green and Color according to the user's preference. Use TINT to adjust flesh tones so they appear natural.

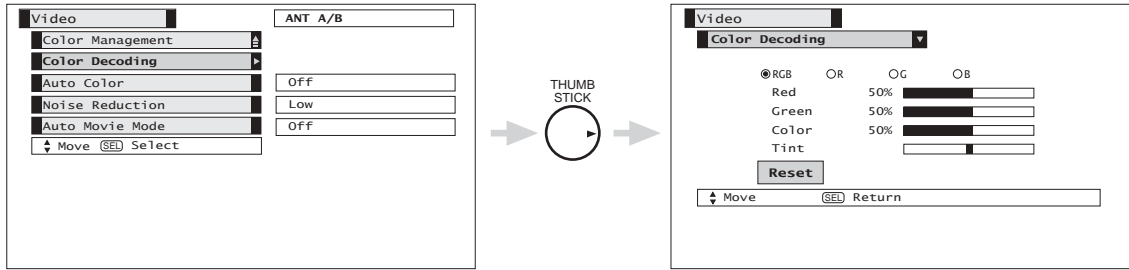

Use THUMBSTICK to highlight function.  
 Press down to select from 4 menu items.  
 Press THUMBSTICK ◀, ▶, ▼, ▲, to highlight and adjust Red, Green, Color and Tint.  
 Use THUMBSTICK to highlight and select "Reset" to return all settings to default.

**NOTE:** Color Decoding settings are independently stored in each of the 4 Color Temperature settings.

## Auto Color

The AUTO COLOR function automatically monitors and adjusts the color to maintain constant color levels even after a program or channel changes. It also maintains natural flesh tones while preserving fidelity of background colors.

**NOTE:** When using Component or DVI-HDTV input, Auto Color will not be available (grayed out).

## Noise Reduction

The NOISE REDUCTION function automatically reduces conspicuous noise in the picture without degrading picture quality. Set NOISE REDUCTION to OFF if the TV experiences picture blocking.

## Auto Movie Mode

The Auto Movie Mode function turns ON or OFF the 3:2 PULLDOWN DETECTION SPECIAL FEATURE. Theatrical movies are shot on film at 24 frames or still pictures per second, instead of 30 frames or 60 fields like video. When film is transferred to video for television viewing, the disparity between the two frame rates must be reconciled. This involves a process known as 3:2 pulldown.

When Auto Movie Mode is turned ON from the VIDEO menu, your Hitachi Plasma Television will activate the circuitry for this special feature to improve video performance when watching film based sources.

**NOTE:** When using Progressive Scan Component or DVI-HDTV input (Ex. 480p, 720p), Auto Movie Mode will not be available (grayed out). Please see table below for additional information.

	ANT A/B, VIDEO, 480i	480p/720p	1080i
50"	AVAILABLE	GRAYED OUT	AVAILABLE
32"/42"	AVAILABLE	GRAYED OUT	GRAYED OUT

**NOTE:** All Video settings are independent of each other based on it's input (ANT A/B, Inputs 1-5).

## Audio

Select AUDIO to adjust the TV to your preference and to improve the sound quality.

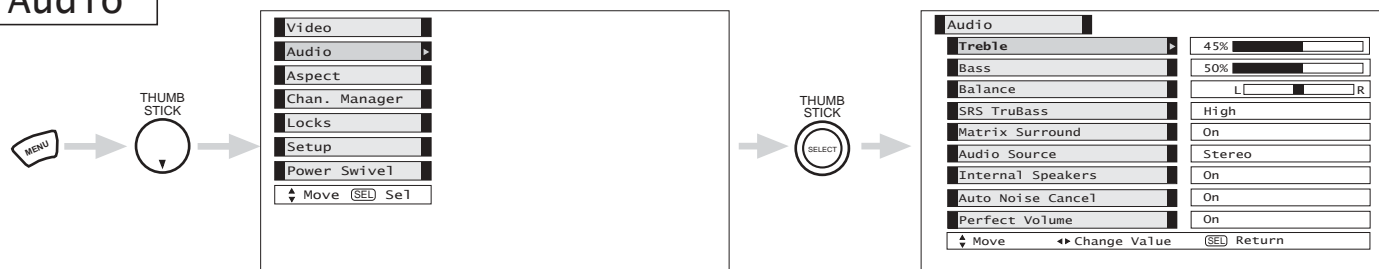

Press THUMB STICK ▲, ▼, to select menu item.  
 Press THUMB STICK ◀ or ▶ to adjust the function.  
 Press EXIT to quit the MENU, or select Audio to return to the main menu.

**NOTE:** If TREBLE is selected you are adjusting treble. The additional menu items Bass and Balance can be selected and adjusted in the same manner.

### Treble

This function controls the high frequency audio to all speakers.

### Bass

This function controls the low frequency audio to all speakers.

### Balance

This function will control the left to right balance of the Plasma TV internal speakers.

### TruBass<sup>®</sup> by SRS (S)

TruBass is an audio enhancement technology from SRS Labs that provides deep, rich bass on any speaker system without the need for a subwoofer or additional extra physical components. For systems with a subwoofer, TruBass complements and enhances the bass performance. This feature can be set to Off, Low, Medium and High.

**NOTES:** TruBass and the (S) symbol are trademarks of SRS Labs, Inc. TruBass technology is incorporated under license from SRS Labs, Inc.

### Matrix Surround

The Matrix Surround features the spacious sound effects of a stadium that can be turned ON or OFF.

### Audio Source

Multi-Channel Television Sound will allow you to select STEREO (a stereo broadcast), MONO (monaural sound) used when receiving a weak stereo broadcast or 2nd Audio Prog (SAP) which may be a secondary language, weather report, etc. The sources received will be displayed at the top right edge of the TV. The source you select will be displayed above the sources received. See example below for each selection when both stereo and second audio are received (monaural is always received).

#### STEREO SELECTED



#### SAP SELECTED

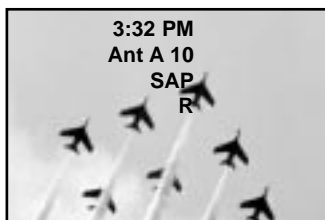

#### MONO SELECTED

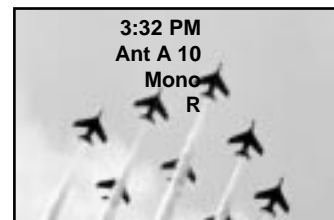

ON-SCREEN DISPLAY

### Internal Speaker

This function is useful when setting up the external speakers. If you prefer to use only speakers from a separate stereo system, turn this feature OFF. When set to OFF, the Plasma TV speakers and the sub-woofer output are OFF. Also, set to OFF, if you prefer to use only your head-phones.

### Auto Noise Cancel

This function eliminates the noise between stations. If a channel is tuned and is noisy, this function will automatically eliminate the audio for that channel.

### Perfect Volume

This function will automatically adjust volume so each channel and input has the same average volume level.

# ASPECT

---

## Aspect Mode

Use this function to select the Picture Format Aspect Ratio.

### Auto Aspect

Automatically adjust the Aspect Ratio depending on the input signal to fill the screen.

Press THUMB STICK ▲, ▼, to select menu item.

Press down on THUMBSTICK to select. A “√” in the box indicates that the feature is ON.

**NOTE:** See page 29 for Aspect Mode availability.

### Vertical Position

This function allows you to select when aspect style is either 4:3 EXPANDED/ZOOM1/ZOOM2 or 16:9 ZOOM. Vertical position can be changed with these modes. For example, it will be useful for centering the picture area at both the top and bottom of the picture with 480i/480P signal. Adjustable range is -10 (video center is toward bottom of screen) to +10 (video center is toward top of screen).

Press THUMB STICK ▲, ▼, to select menu item.

Press THUMB STICK ◀ or ▶ to adjust the function.

Press EXIT to quit the MENU, or select Aspect to return to the main menu.

**NOTE:** Vertical Position will not be available in 4:3 Standard and 16:9 Standard modes.

## Chan. Manager

Select ANTENNA if you are using an indoor or outdoor antenna. Select Cable if you have cable TV.

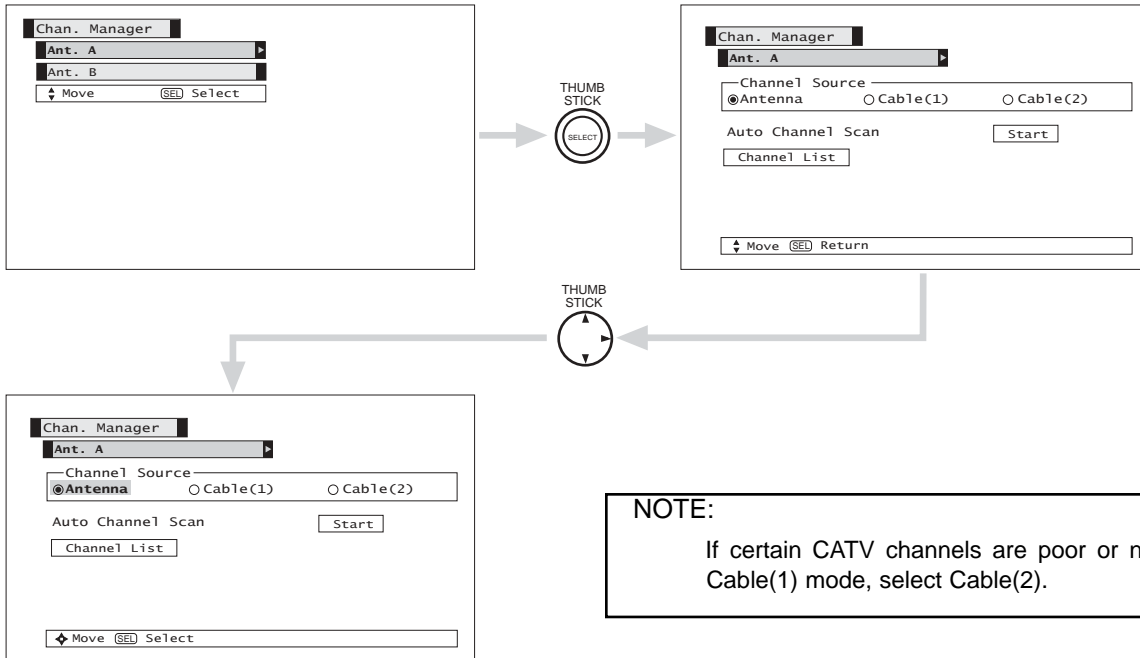

### NOTE:

If certain CATV channels are poor or not possible in Cable(1) mode, select Cable(2).

Use THUMB STICK ◀, ▶ to highlight the correct Channel Source.  
Press the THUMB STICK to select highlighted source.  
Press EXIT to quit the MENU.

RECEPTION BAND		
AIR	CATV 1 OR CATV 2	
	CATV CHANNEL	Indicated on the screen
VHF 2 ~ 13ch UHF 14 ~ 69ch	VHF 2~13	2 ~ 13
	Mid band A~1	14 ~ 22
	A-5 ~ A-1	95 ~ 99
	Super band J~W	23 ~ 36
	Hyper band	37 ~ 64
	W + 1 ~ W + 28	65 ~ 125
	Ultraband	65 ~ 125
	W + 29 ~ W + 84	

Reception channels for each mode are shown at the left.

Refer to your cable or TV guide for channel identification standards.

# CHANNEL MANAGER

## Auto Channel Scan

This feature will automatically store active TV channels in Auto Channel Scan. This will allow you to skip unused channels when using CHANNEL UP (▲) or DOWN (▼).

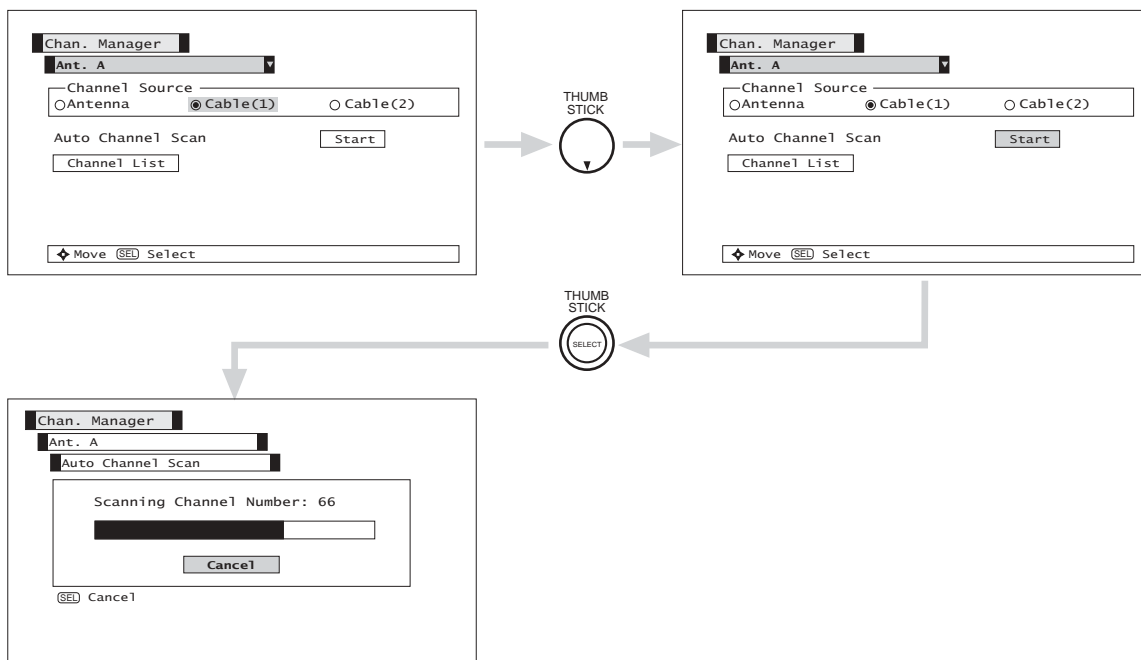

If the EXIT button is pressed while AUTO CHANNEL SCAN function is engaged, programming will stop. If two antennas are connected, switch antenna inputs and repeat AUTO CHANNEL SCAN for the second antenna input.

Remember to select the correct ANTENNA/CABLE mode before using AUTO CHANNEL SCAN. See CHANNEL MANAGER - SCAN to add or to erase additional channels.



## Channel List

This function allows you to review which channels are labeled (CH ID), which have been added to Channel Memory (SCAN), and which are protected by LOCK.

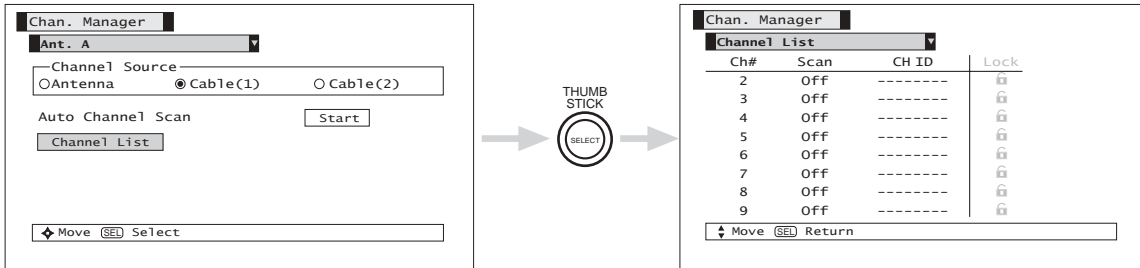

Press THUMB STICK ▲ or ▼ to review more channels.  
Press EXIT to quit the menu.

## Scan

Use this feature after Auto Channel Scan is completed to add (On) or skip (Off) additional channels to the remote control channel ▲ or ▼ buttons.

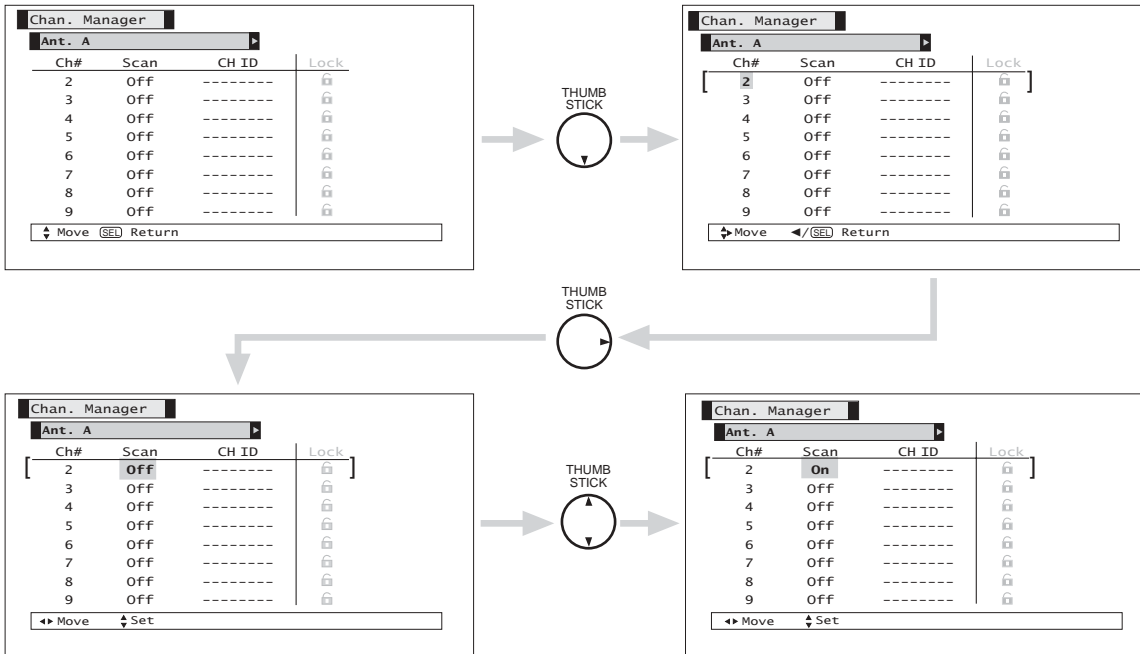

ON-SCREEN DISPLAY

To add (Scan-On) or skip (Scan-Off) additional channels while in Channel Manager, THUMB STICK ◀ to highlight the channel number, then THUMB STICK ▲ or ▼ to highlight other channels. Once the desired channel is highlighted, THUMB STICK ▶ to scan column, then THUMB STICK ▲ or ▼ to select ON or OFF.

**NOTE:** Lock feature cannot be selected or set in CHANNEL MANAGER.

# CHANNEL MANAGER

## Channel ID

This section contains advanced features which will make TV viewing easier and more enjoyable. Use this feature to give up to 20 channels a name when ANTENNA signal source is selected and up to 60 channels a name when CATV signal source is selected.

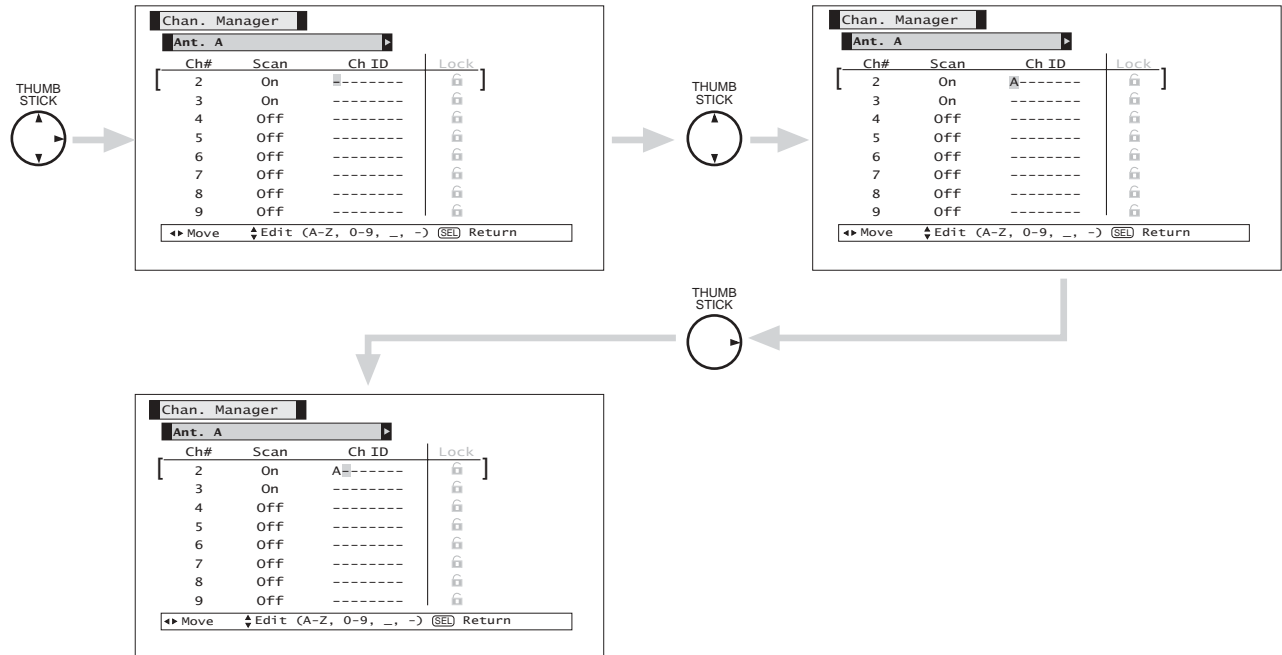

- NOTES:**
1. If ANT A and ANT B are in the same ANTENNA/CABLE mode, the CHANNEL ID for both antenna inputs will be the same.
  2. CHANNEL ID will not be displayed when PIP is ON.

## Locks

This function will block out the picture and sound of the selected channel or video input. It can also be used to keep the TV from being viewed for a scheduled time period that you set.

The code to enter the Locks feature is a four digit secret code number. The factory preset code is 0000. Use the number buttons to select secret code.

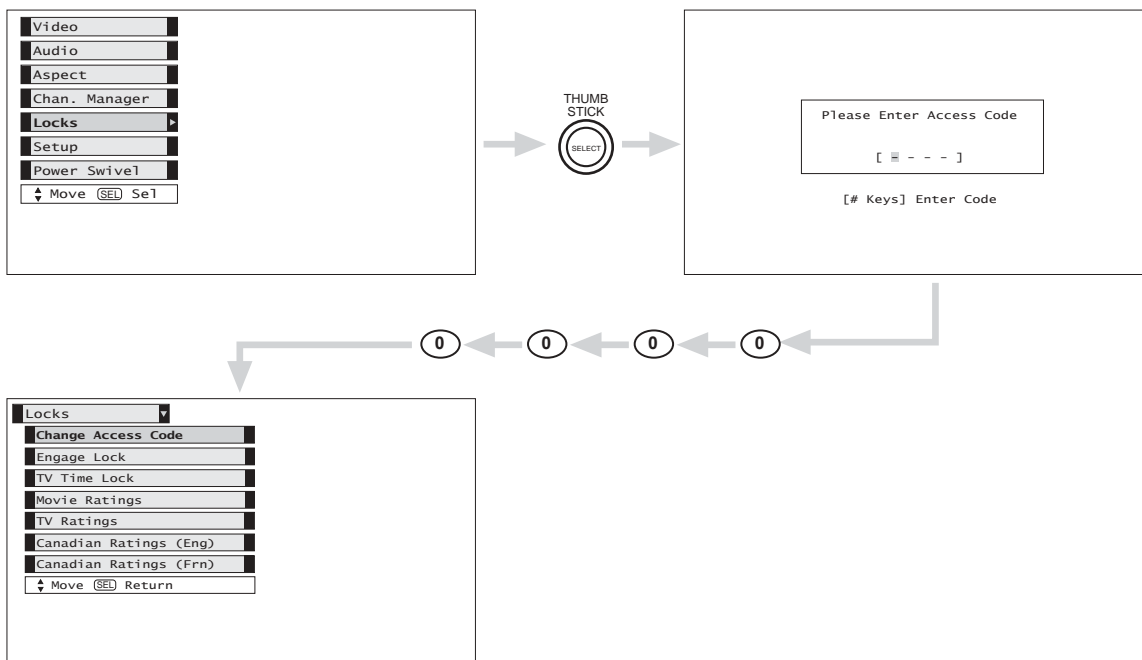

Use THUMB STICK ▲ or ▼ to highlight function and then press SELECT button.

To change the secret code number, select Change Access Code. Enter a new four digit key number you prefer.

Select CHANGE ACCESS CODE to change the factory preset code (0000) to your preference.

When ENGAGE LOCK is selected, SET CHANNEL LOCK, SET INPUT LOCK, and SET FRONT PANEL LOCK can be set individually.

When SET CHANNEL LOCK is turned on, the picture and sound for the chosen channel will be blocked out.

When SET INPUT LOCK is turned on, the picture and sound for all video inputs and the picture and sound for channels 3, 4 will be blocked out.

When FRONT PANEL LOCK is turned on, all buttons on the Front Panel will be deactivated, except the Power button.

When TV TIME LOCK is turned on (☑ TIME LOCK) you can set the BEGIN and END times (THUMB STICK ►) and the TV cannot be viewed during that time period (Set clock first). Use CURSOR ▲ or ▼ to highlight ONCE (TV will time out one time only), DAILY (TV will time out every day), WEEKLY (TV will time out one time a week).

When MOVIE RATINGS is selected, you can block various types of movies and video tapes based on motion picture ratings. Picture-in-Picture will also be blocked automatically (see page 55).

When TV RATINGS is selected, various types of television programming based on a parental guide ratings will be blocked. Picture-in-Picture will also be blocked automatically (see page 56).

Use CANADIAN RATINGS to block various types of movies and television programs based on the two rating systems used in Canada that you feel may be inappropriate due to its content (see pages 57-58).

If you forget your secret code, use the factory code 7777 to erase your key number. This will reset the secret code number back to the factory preset 0000.

Press EXIT to quit the menu.

- NOTE:**
1. If ANT A and ANT B are in the same signal source mode (see page 50), when a channel is locked, it is locked on both antenna inputs.
  2. When using TV TIME LOCK make sure the clock is set (see page 61).
  3. Text appears on the screen to indicate that TV TIME LOCK is activated.
  4. If MOVIE/TV Ratings Lock function settings are ON, SURF will be deactivated.

# LOCKS

## Movie Ratings

Use MOVIE RATINGS to prevent viewing of any movie that you feel may be inappropriate due to its content.

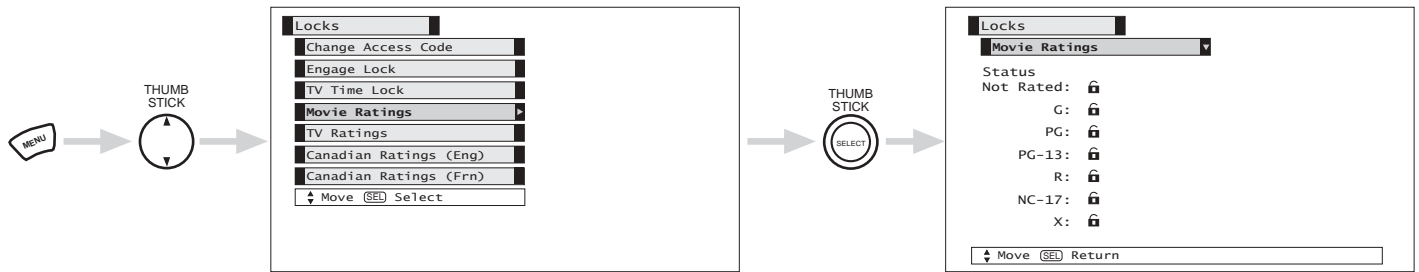

Use THUMB STICK ▲ or ▼ to select the MOVIE RATING category that you want to block. Press SELECT to block the MOVIE RATING that you have selected. Once rating is selected, for example PG-13, all movies rated PG-13 and higher (R, NC-17, and X) will be blocked. Press EXIT to quit the menu or select MOVIE RATING to return to the previous menu.

## Motion Picture Ratings Chart

G	<b>General audiences.</b> All ages admitted.
PG	<b>Parental guidance suggested.</b> Some material may not be suitable for children.
PG-13	<b>Parents strongly cautioned.</b> Some material may be inappropriate for children under 13.
R	<b>Restricted.</b> Under 17 requires accompanying parent or adult guardian.
NC-17	<b>No one 17 and under admitted.</b>
X	<b>Adults only</b>
NOT RATED (NR)	<b>Contains no rating. Not Rated (NR) and Not Applicable (NA) programs.</b> Movie has not been rated or ratings do not apply.

- NOTES:**
1. A movie rating is dependent upon the movie that is viewed. If the movie does not carry a rating, the TV will not block it.
  2. Blocking "NOT RATED (NR)" programs may block emergency programming, sports, news, public service announcements, religious programs and weather.

## TV Ratings

Use TV RATINGS to prevent the viewing of any TV program that you feel may be inappropriate due to its content.

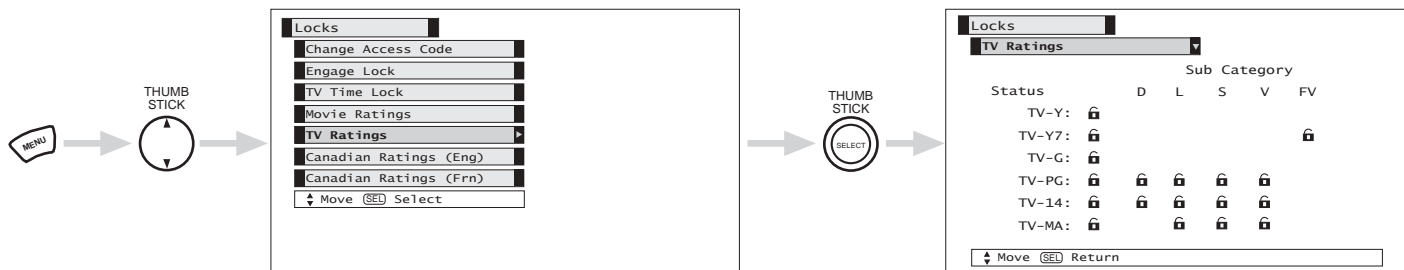

Use THUMB STICK ▲ or ▼ to highlight the category that you want to block.  
 Press select to block the TV RATINGS that you have selected.  
 Press EXIT to quit the menu or select TV RATINGS to return to the previous menu.

## TV Parental Guide Ratings Chart

N/A	None.
TV-Y	<b>All children.</b> The themes and elements in this program are specifically designed for a very young audience, including children from ages 2-6.
TV-Y7	<b>Directed to older children.</b> Themes and elements in this program may include mild physical or comedic violence, or may frighten children under the age of 7.
TV-G	<b>General audience.</b> It contains little or no violence, no strong language, and little or no sexual dialogue or situations.
TV-PG	<b>Parental guidance suggested.</b> The program may contain infrequent coarse language, limited violence, some suggestive sexual dialogue and situations.
TV-14	<b>Parents strongly cautioned.</b> This program may contain sophisticated themes, intense sexual situation, more intense violence and intensely suggestive dialogue.
TV-MA	<b>Mature audiences only.</b> This program may contain mature themes, indecent language, graphic violence, and explicit sexual content.
FV	<b>Fantasy Violence</b>
V	<b>Violence</b>
S	<b>Sexual Situation</b>
L	<b>Adult Language</b>
D	<b>Sexually Suggestive Dialogue.</b>

### NOTES:

1. If you Block TV-14D, you will still permit TV MA programs; If you block TV-14DV, you will automatically block TV-MAV programs, but you will still permit TV-MALS programs. This means that the TV will block violence in TV-14 and higher (TV-MA), but not language and sex.
2. TV program ratings are dependent on the broadcaster. If the program is not rated, the TV will not block it.

# LOCKS

## Canadian Ratings (Eng)

Use Canadian Ratings (Eng) to block various types of movies and television programs used in Canada that you feel may be inappropriate due to its content.

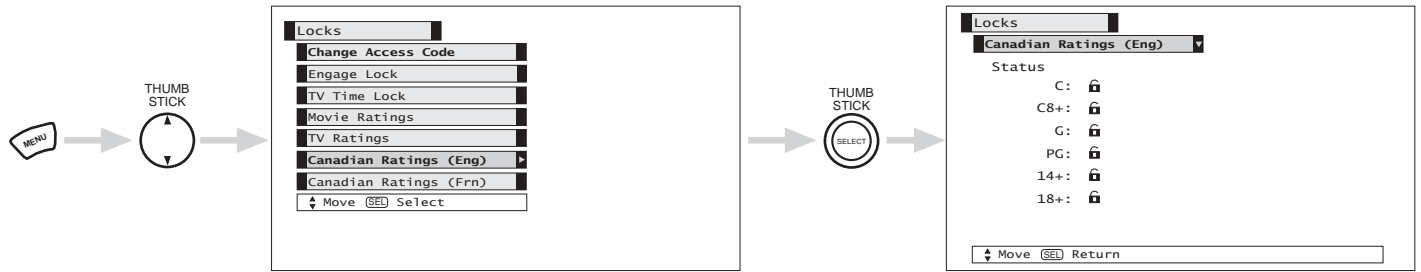

Use THUMB STICK ▲ or ▼ to select the CANADIAN RATINGS (Eng) category that you want to block. Press SELECT to set the CANADIAN RATINGS (Eng) that you have selected. Once rating is selected, for example C8+, all movies and television programs rated C8+ and higher (G, PG, 14+ and 18+) will be blocked automatically. Press EXIT to quit the menu.

## Canadian Ratings English Chart

C	<b>Programming intended for children under age 8</b> - Violence Guidelines: Careful attention is paid to themes, which could threaten children's sense of security and well-being. There will be no realistic scenes of violence. Depictions of aggressive behaviour will be infrequent and limited to portrayals that are clearly imaginary, comedic or unrealistic in nature. Other Content Guidelines: There will be no offensive language, nudity or sexual content.
C8+	<b>Programming generally considered acceptable for children 8 years and over to watch on their own</b> - Violence Guidelines: Violence will not be portrayed as the preferred, acceptable, or only way to resolve conflict; or encourage children to imitate dangerous acts which they may see on television. Any realistic depictions of violence will be infrequent, discreet, of low intensity and will show the consequences of the acts. Other Content Guidelines: There will be no profanity, nudity or sexual content.
G	<b>General Audience</b> - Violence Guidelines: Will contain very little violence, either physical or verbal or emotional. Will be sensitive to themes which could frighten a younger child, will not depict realistic scenes of violence which minimize or gloss over the effects of violent acts. Other Content Guidelines: There may be some inoffensive slang, no profanity and no nudity.
PG	<b>Parental Guidance</b> - Programming intended for a general audience but which may not be suitable for younger children. Parents may consider some content inappropriate for unsupervised viewing by children ages 8-13. Violence Guidelines: Depictions of conflict and/or aggression will be limited and moderate; may include physical, fantasy, or supernatural violence. Other Content Guidelines: May contain infrequent mild profanity, or mildly suggestive language. Could also contain brief scenes of nudity.
14+	<b>Programming contains themes or content which may not be suitable for viewers under the age of 14</b> - Parents are strongly cautioned to exercise discretion in permitting viewing by pre-teens and early teens. Violence Guidelines: May contain intense scenes of violence. Could deal with mature themes and societal issues in a realistic fashion. Other Content Guidelines: May contain scenes of nudity and/or sexual activity. There could be frequent use of profanity.
18+	<b>Adult</b> - Violence Guidelines: May contain violence integral to the development of the plot, character or theme, intended for adult audiences. Other Content Guidelines: May contain graphic language and explicit portrayals of nudity and/or sex.

## Canadian Ratings (Frn)

Use CANADIAN RATINGS (FRN) to block Canadian French programs according to various program ratings that you feel may be inappropriate due to its content.

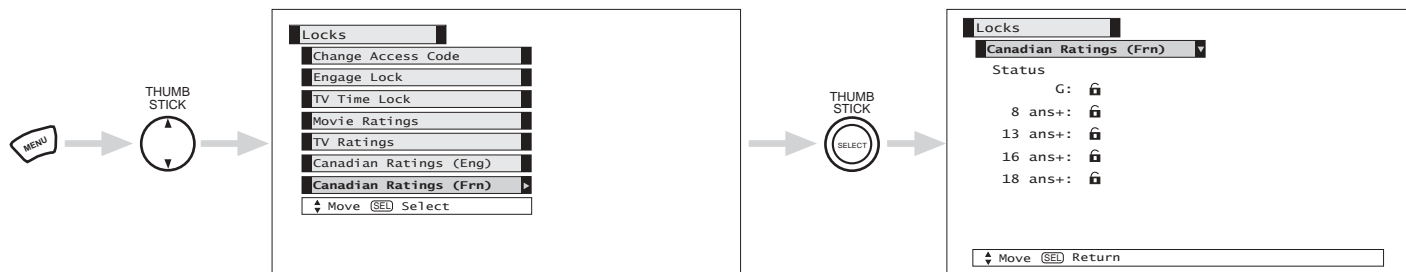

Use THUMB STICK ▲ or ▼ to highlight the category that you want to block.

Press SELECT to set the CANADIAN RATINGS (FRN) that you have selected.

Once rating is selected, for example 8 ans+, all movies and television programs rated 8 ans+ and higher (13 ans+, 16 ans+, 18 ans+) will be automatically blocked.

Press EXIT to quit the menu.

## Canadian Ratings French Chart

G	<b>General</b> - Programming intended for audiences of all ages. Contains no violence, or the violence content is minimal or is depicted appropriately with humor or caricature or in an unrealistic manner.
8 ans +	<b>8 + General - Not recommended for young children</b> - Programming intended for a broad audience but contains light or occasional violence that could disturb young children. Viewing with an adult is therefore recommended for young children (under the age of 8) who cannot differentiate between real and imaginary portrayals.
13 ans +	<b>Programming may not be suitable for children under the age of 13</b> - Contains either a few violent scenes or one or more sufficiently violent scenes to affect them. Viewing with an adult is therefore strongly recommended for children under 13.
16 ans +	<b>Programming is not suitable for children under the age of 16</b> - Contains frequent scenes of violence or intense violence.
18 ans +	<b>Programming restricted to adults</b> - Contains constant violence or scenes of extreme violence.

# SETUP

## Setup

Select SETUP when setting up your TV for the first time. Use the THUMB STICK ▲ or ▼ on the remote to highlight the function desired.

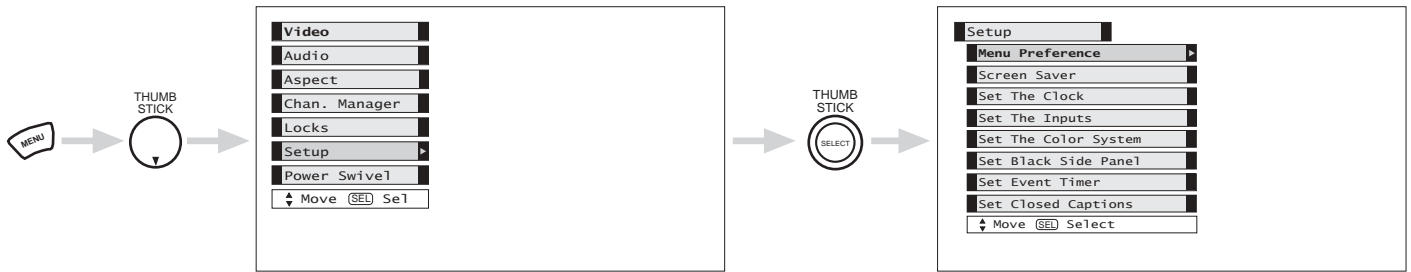

Use THUMB STICK ▲ or ▼ to select the sub-menu of your choice.

## Menu Preference

This feature will allow you to select any one of three different languages for all on-screen displays.

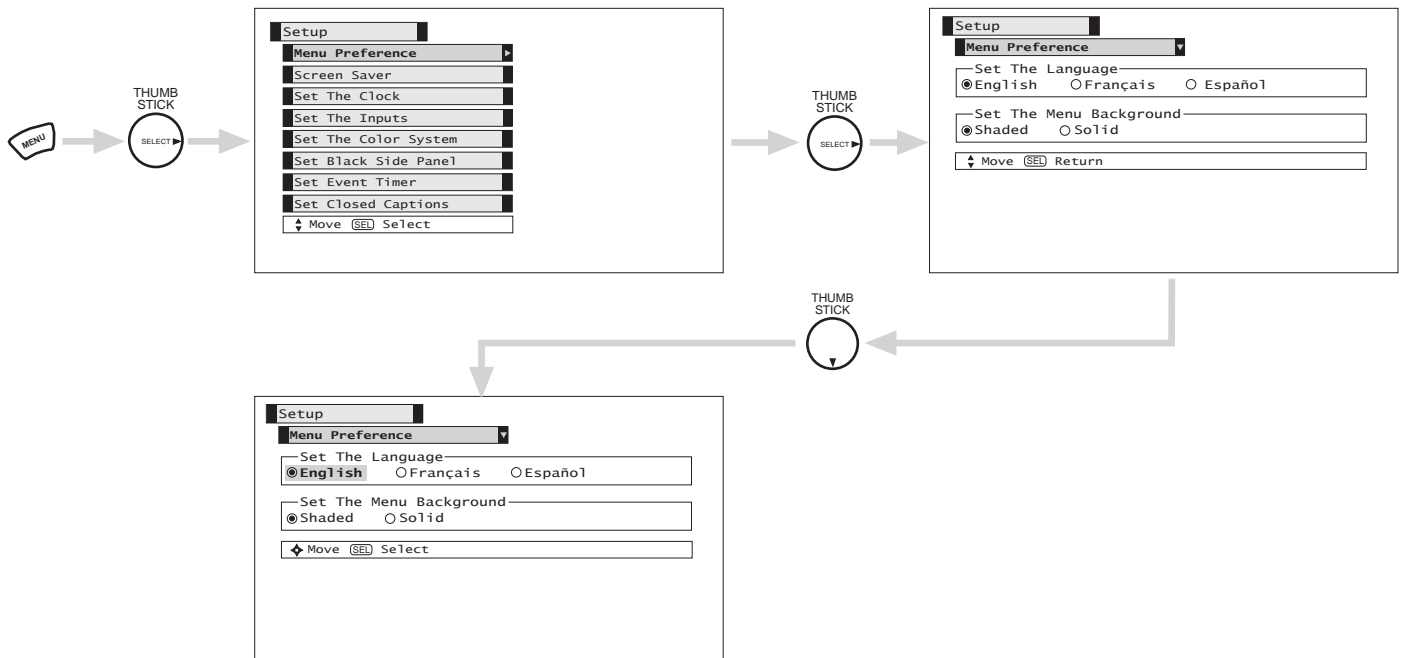

Use THUMB STICK ◀, ▶ to highlight the language of your choice. Press SELECT to select the highlighted language. Press EXIT to quit the menu.



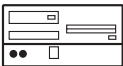

## Menu Background

This function allows you to choose from two menu backgrounds.

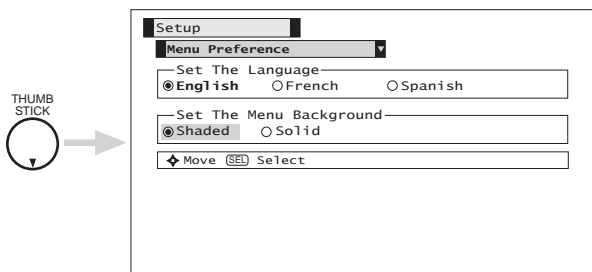

Use THUMB STICK ◀, ▶ to highlight SET THE MENU BACKGROUND (shaded or solid), and press down on THUMB STICK to select the setting.

Press EXIT to quit the menu.

Select SOLID and background is visible (no picture can be seen behind menu screen), select SHADED and a light background is visible.

## Screen Saver

Continuous on-screen displays such as video games, stock market quotations, computer generated graphics, and other fixed (non-moving) patterns can cause permanent damage to Plasma Television. Use the SCREEN SAVER feature to hide screen burn.

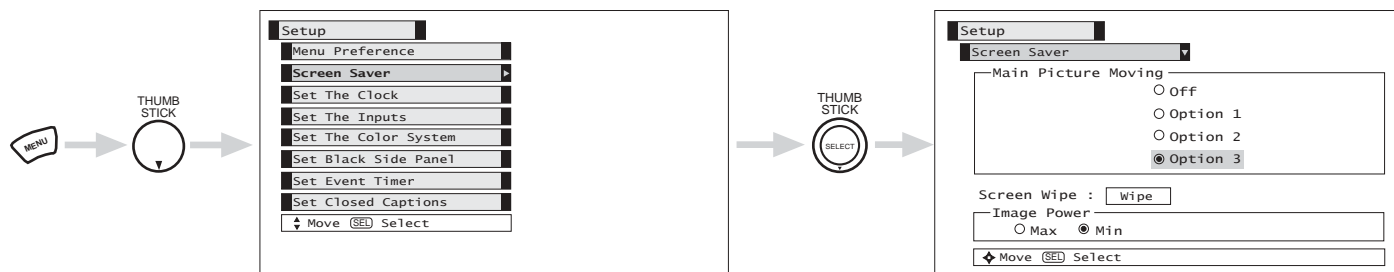

Use THUMB STICK ▲, ▼ to highlight Screen Saver's Main Picture Moving options. Press down on THUMB STICK to select and EXIT to quit.

### Option 1

The whole picture will shift every 20 minutes by two pixels.

### Option 2

The whole picture will shift every 40 minutes by two pixels.

### Option 3

The whole picture will shift every 60 minutes by two pixels.

### Screen Wipe

If pattern mark occurs, use Screen Wipe (White Field Signal) for at least 10 minutes to refresh any damage that may have occurred from a pattern mark. Screen Wipe can resolve pattern mark to a certain degree, if caution is not used, permanent damage may occur. Press the EXIT button to return to normal viewing.

### Screen Saver Picture's Movement

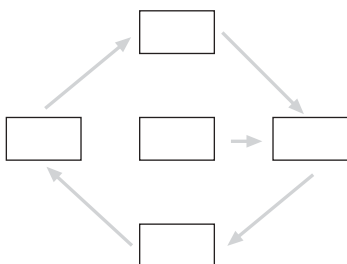

## Image Power

(50" Model Only)

This function allows you to choose Power Consumption reduction.

# SETUP

## Set The Clock

The time must be set before you can Set Event Timer or TV Time Out.

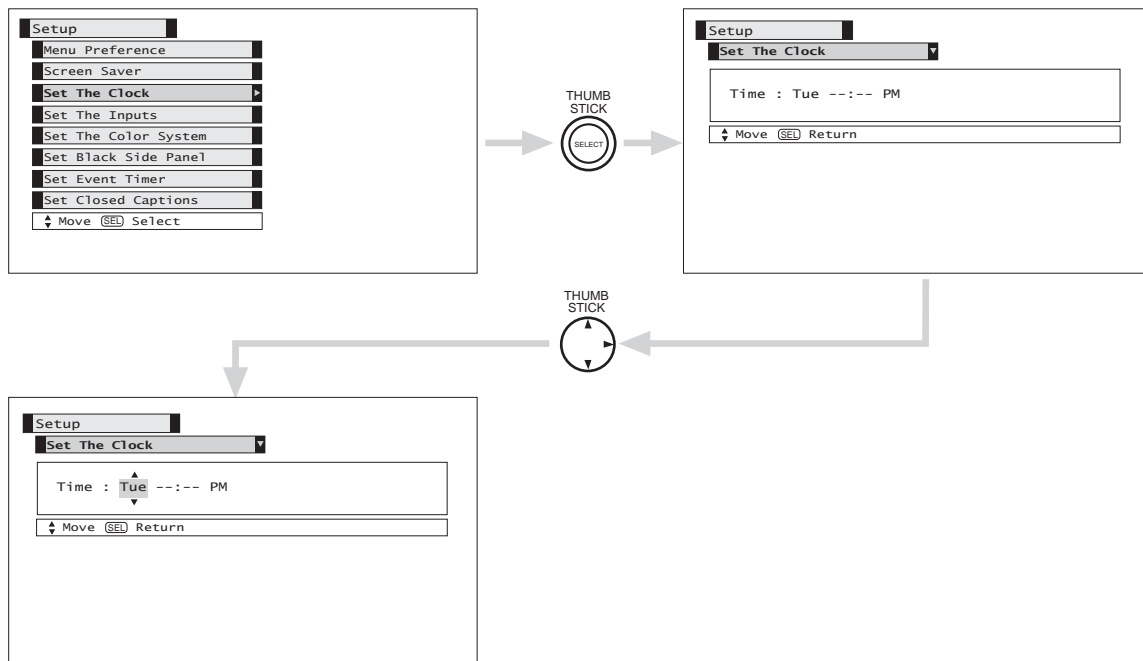

Use THUMB STICK ▲ or ▼ to set the time, and day of the week.  
Press THUMB STICK ◀ or ▶ to change position.  
Press EXIT to quit the menu.

## Set The Inputs

Use this feature to give a name to any of the five video inputs.

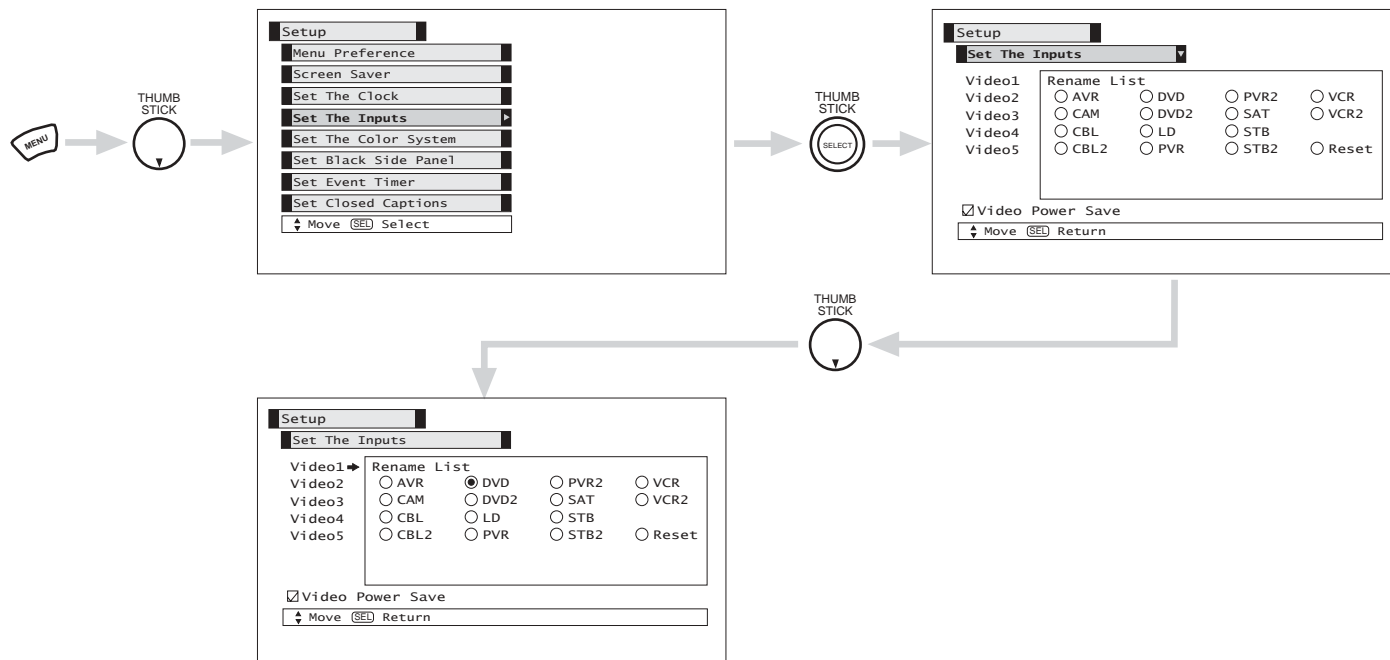

Press THUMB STICK ▲, ▼ to highlight the name of the video inputs.  
Press down on THUMB STICK to select desired input name.

Select RESET to set video names to original factory preset condition.

**NOTE:** The video input name will be displayed only when video input is displayed as main picture.

## Video Power Save

Use this feature to reduce power consumption for video input when there is no video input signal. In RGB mode, this feature will always be on.

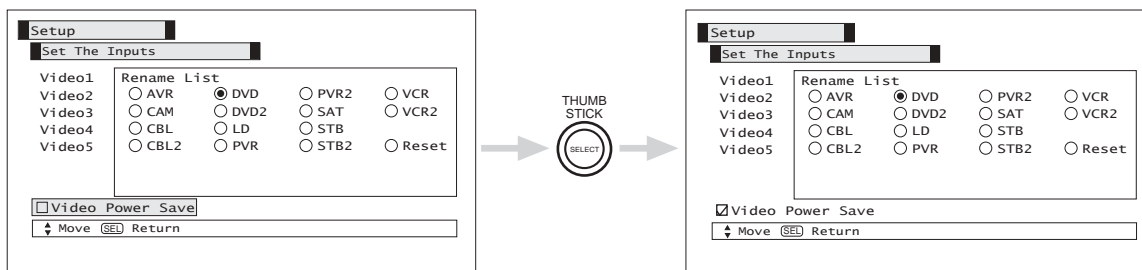

Press THUMB STICK ▼ to highlight VIDEO POWER SAVE.  
Press down on THUMB STICK to select.

# SETUP

## Video 2 Auto Link

Use this function to automatically turn the TV on and tune to Video 2 when it detects a video signal to input 2.

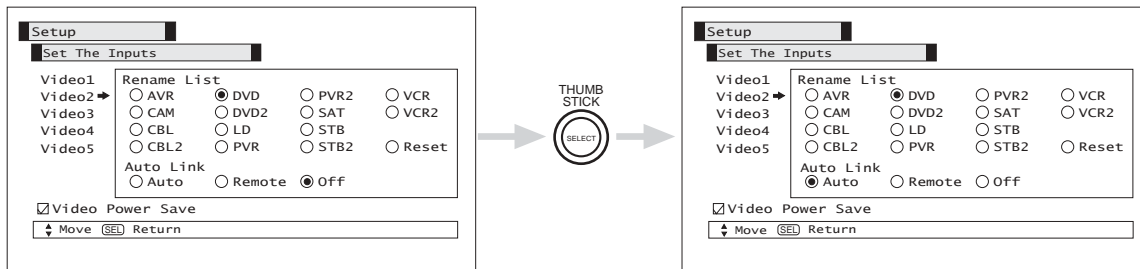

Use THUMB STICK ▲, ▼, ◀, ▶ then press down on THUMB STICK to change AUTO LINK setting.

When AUTO is selected, the TV will turn on and switch to Video2 automatically, when the Video2 input device is turned on. This is convenient when you want to watch a movie with your VCR, laserdisc player, or DVD player.

When REMOTE is selected, the TV will turn on and switch to Video2 automatically when the Video2 input device is turned on (VCR, laserdisc, or DVD) and any of the buttons on your remote control is pressed.

Select Off to disable this function.  
Press EXIT to quit the menu.

- NOTES:**
1. Once the TV has been turned on using the AUTO LINK feature, it must be reset before AUTO LINK is used again. To do this, turn your VCR, laserdisc, or DVD player OFF. This feature is now reset and will turn on your TV as described above.
  2. When using REMOTE mode, any remote control button will substitute for your video input device play button. However, intended operation is for use with your VCR, laserdisc, or DVD play button.
  3. If no remote control button is pressed after the TV is turned on by AUTO LINK, the TV will automatically turn off after three hours.

## Set The Color System

This function allows you to automatically change tint and color coordinates for DTV programs.  
AUTO - Automatically determines the color system for the input signal.  
HDTV - High Definition Television - Use for High Definition Signal Y-P<sub>B</sub>P<sub>R</sub> from HDTV Set-Top Box.  
SDTV/DVD - Standard Definition Television or DVD (Digital Versatile Disc Player) Y-C<sub>B</sub>C<sub>R</sub>.

- NOTES:**
1. If Color System is set improperly (does not match actual input signal), the color and tint of the main picture will be abnormal.
  2. All component color system settings will affect only color component input you are currently viewing. If you are using both sets of component input jacks, be sure to set the color system feature for both inputs.

## Set Black Side Panel

The BLACK SIDE PANEL function turns the gray side bars on/off when watching 4:3 signals in Standard mode.  
When the Plasma Television is powered OFF, BLACK SIDE PANEL feature will be set to OFF automatically when the TV is powered ON. BLACK SIDE PANEL feature needs to be set every time the TV is turned ON.  
The top/bottom gray bar will appear in SPLIT MODE PIP and SPLIT FREEZE.

**NOTE:** To prevent screen burn when watching 4:3 signal, turn off the BLACK SIDE PANEL. It is recommended to watch 4:3 signal with gray side bar.

## Set Event Timer

This function will automatically turn the Plasma TV on and off, one time only, every day, or once a week.

If the clock is not set, you can not use this function and the screen below will appear. The message on the screen will disappear after 3 seconds, then the screen automatically goes to the clock setup mode (see page 61).

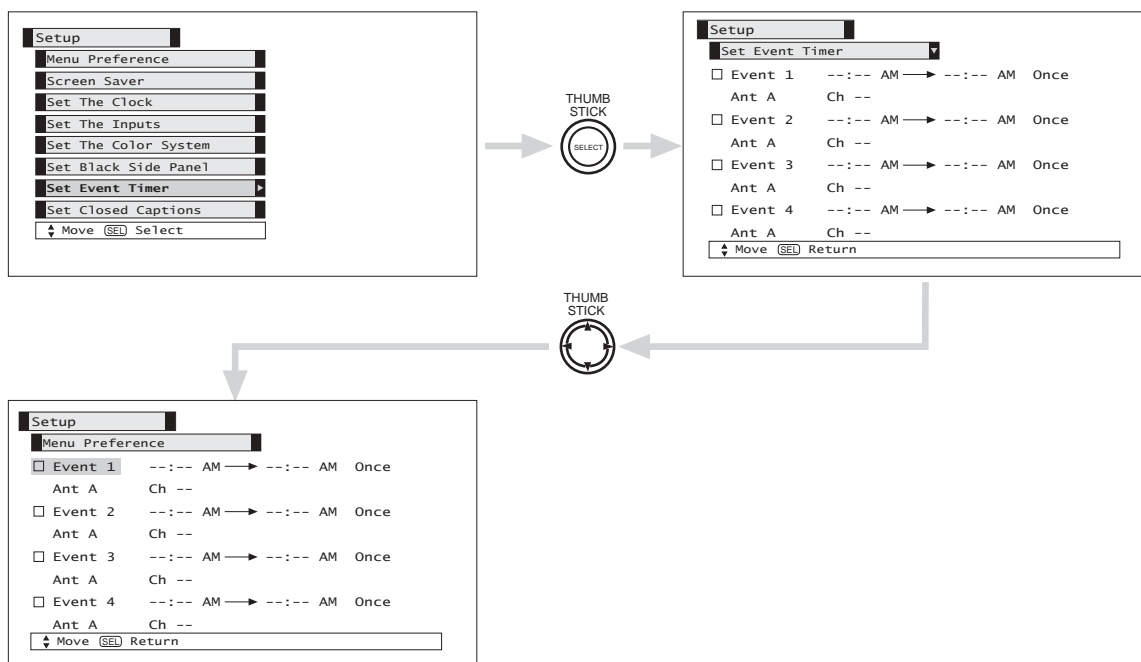
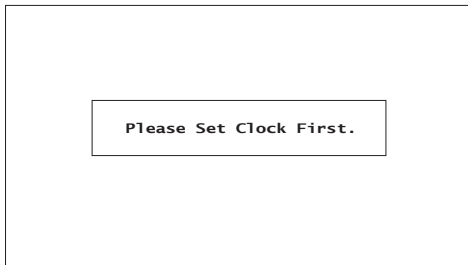

- Use THUMB STICK ▼ to select Event 1, 2, 3 or 4.
- Use THUMB STICK ► to change position of On time, Off time, Antenna, Channel, and On/Off Frequency.
- Use THUMB STICK ▲ or ▼ to select the time the TV will turn on and off.
- Use THUMB STICK ▲ or ▼ to select the day of the week you want the timer to turn on TV.
- Use number buttons to set the channel the TV will tune to when it automatically turns on.
- Use THUMB STICK ▲ or ▼ to select mode Once (TV will turn on/off one time only), Daily (TV will turn on/off at the same time every day), or Weekly-Sun (TV will turn on/off at same time every week).
- Press EXIT to quit the menu.



**CAUTION:** Do not use your TV as a deterrent when away from home by using the On and Off Timers. For safety, the TV should be turned off when you are away from home.

**NOTE:** If your TV is ON when an Event is triggered, it will remain ON after the Event has finished. If your TV is OFF (Stand-by Mode) when the Event is triggered, it will automatically turn OFF when the Event Timer reaches it's turn OFF time.

# SETUP

## Closed Caption

Closed Captions are the dialogue, narration, and/or sound effects of a television program or home video which are displayed on the Plasma Television screen. Your local TV program guide denotes these programs as **CC** or .

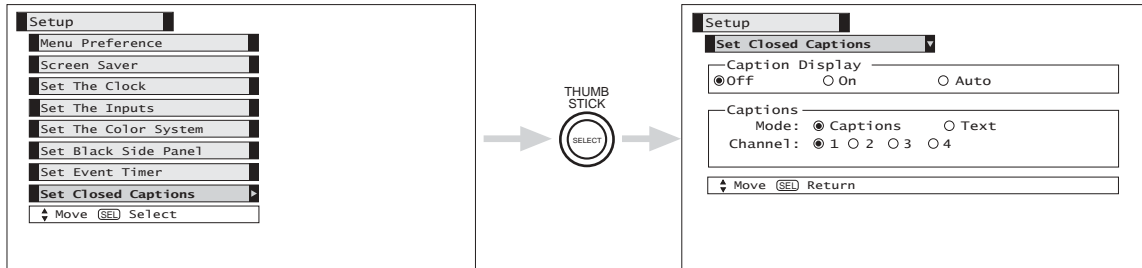

**Caption Display:** **On/Off** will turn the **CC** display on or off.

**Auto** will turn the **CC** display on when Mute/Soft Mute is on.

**Captions Mode:** **Captions** is for the program you are viewing.

**Text** is for additional information such as news reports or a TV program guide. This information covers the entire screen and viewing the TV program is not possible. Text may not be available with every **CC** program.

**Captions Channel:** 1 is used for the primary language (usually English).  
2 is sometimes used for a second language (may vary by region).  
3 is sometimes used for a third language (may vary by region).  
4 is sometimes used for a fourth language (may vary by region).

Use THUMB STICK ▲, ▼ to highlight the function to change then press THUMB STICK to change the function. Press EXIT to quit menu or THUMB STICK ◀ to return to previous menu.

- NOTES:**
1. CAPTION DISPLAY will not work when viewing a 480P, 720P, or 1080i input via the COMPONENT: Y-P<sub>B</sub>P<sub>R</sub> or DVI-HDTV inputs.
  2. When PIP Surf Mode is on, Closed Caption will not work.

## Power Swivel

This feature controls the motorized stand for the 32" and 42" models. It allows the customer to turn the plasma display left or right using the remote control.

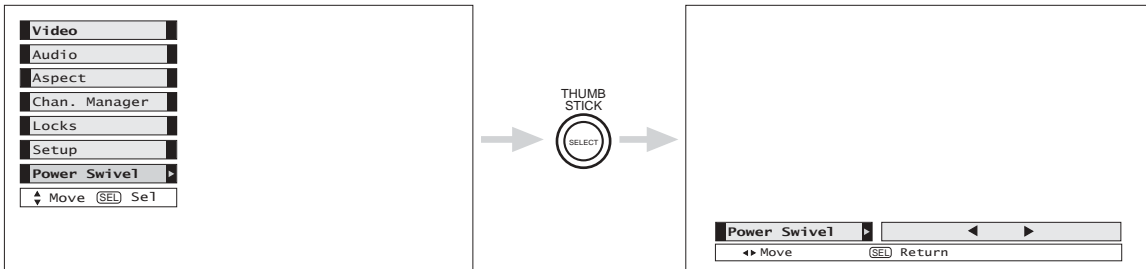

Use THUMB STICK ► to rotate the TV to the right.  
Use THUMB STICK ◀ to rotate the TV to the left.  
Release the THUMBSTICK to stop rotation.

- NOTES:**
1. The Power Swivel has a maximum turning radius of 30° (left and right).
  2. Do not place any objects on the path of the monitor when using the power swivel feature.
  3. Before using the power swivel feature, please make sure that the path of the monitor is clear of any fingers, hands or any other body parts to avoid causing injury.

# RGB ON SCREEN DISPLAY

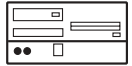

**IMPORTANT:** TURN OFF THE AVC BOX, THE DISPLAY MONITOR AND THE EXTERNAL COMPONENT BEFORE CONNECTING OR DISCONNECTING ANY CABLES.

1. AVC rear panel connection to an external component with an analog RGB output.

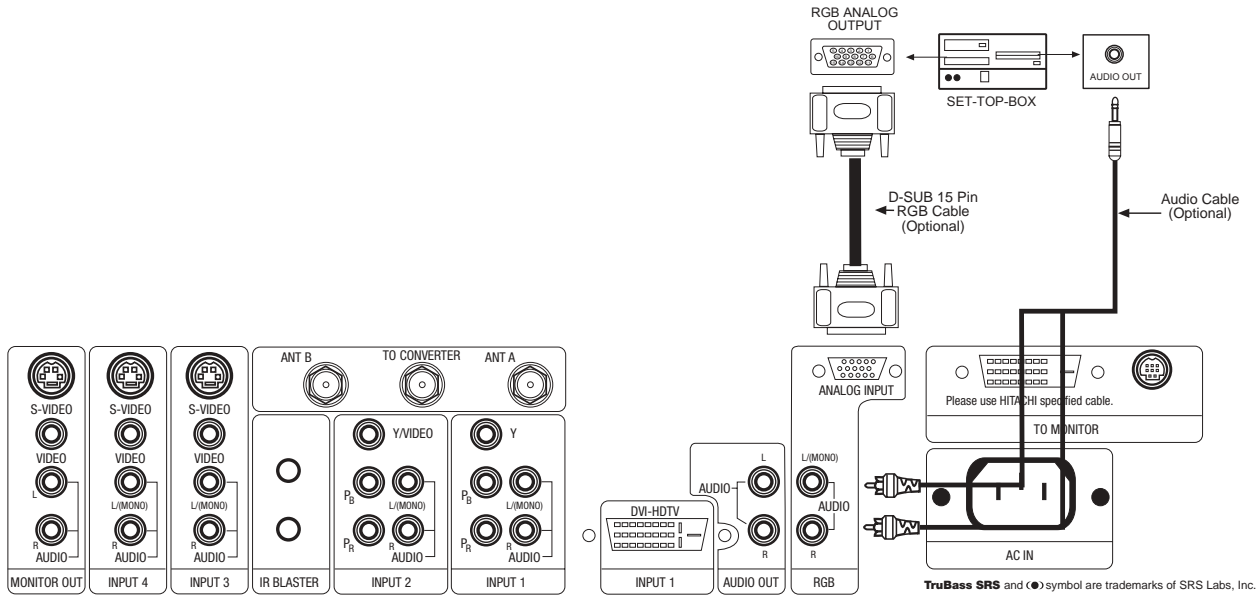

This Plasma Television can automatically detect and display the signal format below.

- 1. RGB input signal.  
This Plasma Television can accept the following signal formats.

Recommended Signal List

No.	Signal Mode			Horizontal Frequency (kHz)
	Signal Name	Resolution	Vertical Frequency (Hz)	
1	VESA	640 x 400	70.09	31.47
2	VGA	640 x 480	59.94	31.47
3	VESA	640 x 480	72.81	37.86
4		640 x 480	75.00	37.50
5		800 x 600	56.25	35.16
6		800 x 600	60.32	37.88
7		800 x 600	72.19	48.08
8		800 x 600	75.00	46.88
9		1024 x 768	60.00	48.36
10		1024 x 768	70.07	56.48
11		1024 x 768	75.03	60.02
12		1280 x 1024	60.02	63.98
13	1280 x 1024	75.03	79.98	
14	1080i	1080	59.94	33.72
15	720p	720	59.94	44.96
16	480p	480	59.94	31.47

**NOTE:** 1. Dots correspond to the true resolution in Real Mode of aspect ratio, when you select VGA 640 x 480 signal from the table above. (One dot corresponds to one pixel). In addition, XGA (1024 x 768) and SVGA (800 x 600) for 50".  
2. Always reset AUTO ADJUST feature when setting new display setting or when changing to a new computer (see page 74).



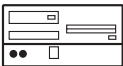

## RGB ON SCREEN DISPLAY

2. The new setting (horizontal position, vertical position, clock, and phase) of the signal will be stored. The monitor can store up to 13 settings in addition to the 15 pre-set signal timing. Any additional new settings (more than 15) will over-write the first user's setting, second setting and so on.
3. Operation in RGB mode in relation to TV functions are shown below.

No.	Item	Operation
1	Event Timer	Only power on is available.
2	Video Control	Contrast and brightness work separately, however, other picture controls are not available.
3	AV Net	Available.
4	Audio Settings	Not available.
5	Closed Caption	Not available.
6	Clock	Clock indication is available.
7	Sleep Timer	Available.
8	Monitor Out	Both picture and audio are not available.
9	Lock	Not available.
10	Front Panel Lock	Available.
11	Auto Link	Turn on to TV mode.
12	Menu Background	Available.

# RGB ON SCREEN DISPLAY

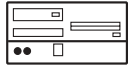

- 4. Other signal formats may not be displayed correctly. Use AUTO ADJUST to automatically adjust the horizontal position, vertical position, clock, and phase. We recommend you use a signal, which has more than 50% of amplitude of white area at each corner of the picture, when performing Auto Adjustment. It may not work correctly with dark picture (see page 74).
- 5. Input signal level.

SYNC	TTL level H/V separate signal
RGB INPUT	0.7Vpp/1.0Vpp

**NOTE:** Interlaced signal is not available.

- 6. RGB input signal will not appear at all when receiving a signal which is not supported by this product. If the setting is wrong, the Display Monitor will display:



NO SYNC. SIGNAL

Without sync

POWER SAVING mode will come on after 10 seconds.



INVALID SCAN FREQ.

Either horizontal or vertical frequency is inappropriate or out of range.

INVALID SCAN FREQ. will disappear after 60 seconds.

**NOTE:** 1. If the Display Monitor cannot display a signal, please try AUTO ADJUST to display the signal. This is used to initialize the MultiScan Converter.  
2. Not all signals have AUTO ADJUST feature (see page 74).  
3. Set-Top-Box and DVD player input signal does not have AUTO ADJUST feature.

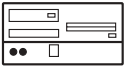

# RGB ON SCREEN DISPLAY

## USING THE RGB INPUT

1. Press TV/RGB button on the remote control to switch between TV and RGB modes.
2. Press MENU on the remote control to display the different features in RGB MODE.
3. Press the THUMB STICK ▲, ▼, ◀, ▶ buttons to highlight a different feature.
4. Press EXIT on the remote control to quickly exit from a menu.

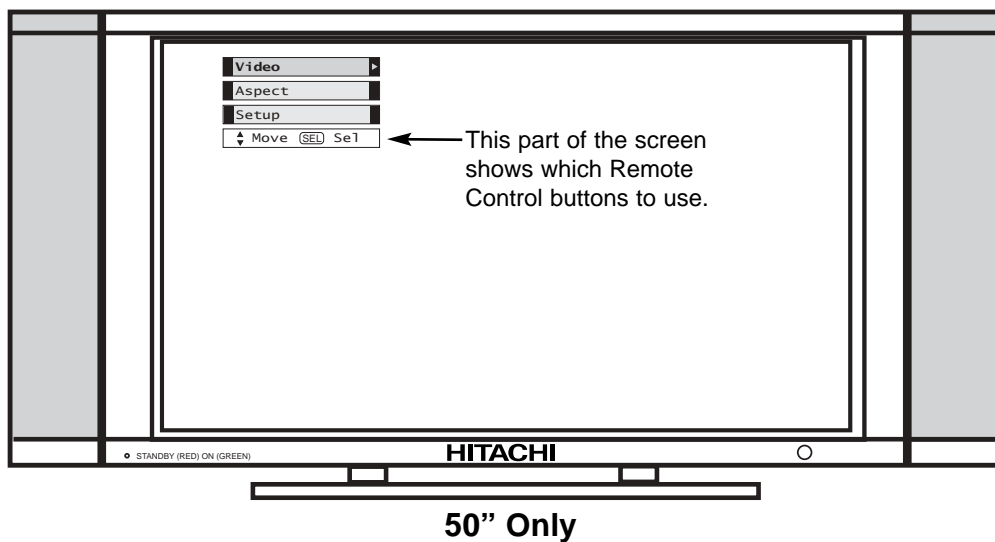
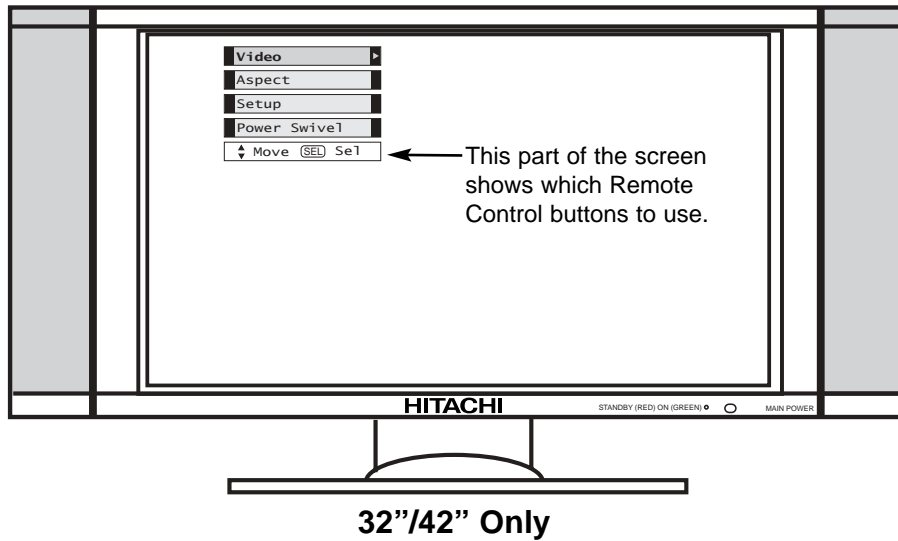
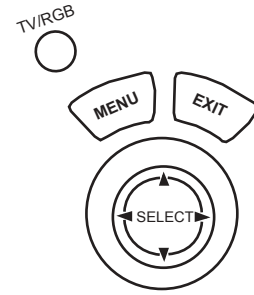

- NOTES:**
1. The Power Swivel OSD will not be available for the 50" model.
  2. When the Power Swivel connection cable is disconnected, the Power Swivel OSD will disappear.

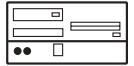

Video	Contrast	Change the contrast between black and white levels in the picture.
	Brightness	Adjust overall picture brightness.
	Color Temperature	Select between HIGH (9,300K), MEDIUM (7,500K), STANDARD (6,500K), or Black/White (5,400K).
	Enhancer	Enhance picture details (Off, Low, Medium or High).
	Reset	Recall the factory preset data of the RGB Video Settings.
Aspect	Real	Aspect as it is presented in its true resolution.
	Normal	Aspect in 4:3 standard.
	Full	Aspect in 16:9 standard.
Setup	Auto Adjust	Automatically adjust the geometry to fit the screen.
	Horizontal Position	Adjust horizontal position.
	Vertical Position	Adjust vertical position.
	Horizontal Clock	Adjusts the dot clock frequency to reduce the vertical stripe.
	Clock Phase	Adjusts the phase to correct blurred or unstable images.
	Reset	Recall the factory preset data of the RGB setup settings.
	Input Level	Set the preferred input signal level.
Black Side Panel	Turns the gray side bars ON/OFF when watching Aspect in Real and Normal signals in standard mode.	
Power Swivel	Power Swivel	Controls the motorized stand for 32"/42" models.

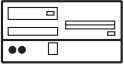

# RGB ON SCREEN DISPLAY

## VIDEO ADJUSTMENTS

The following adjustments are independent of the TV mode:

- Press MENU in RGB mode for on screen display.
- Press THUMB STICK ▲ or ▼ to highlight the item to be adjusted.
- Press SELECT to select the highlighted item.

### CONTRAST

This feature allows you to adjust the contrast in RGB mode.

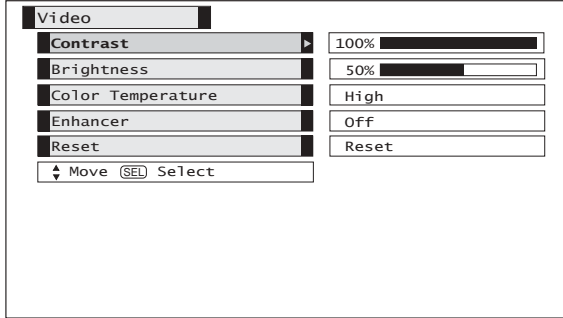

Use THUMB STICK ◀ or ▶ to adjust contrast. Press MENU button to return to RGB MODE MENU and EXIT to quit.

**NOTES:**

1. Contrast can be set up to 110% if THUMBSTICK ▶ is pressed and held for more than 3 seconds.
2. See TV contrast feature for additional information regarding contrast.

### BRIGHTNESS

This feature allows you to adjust brightness in RGB Mode.

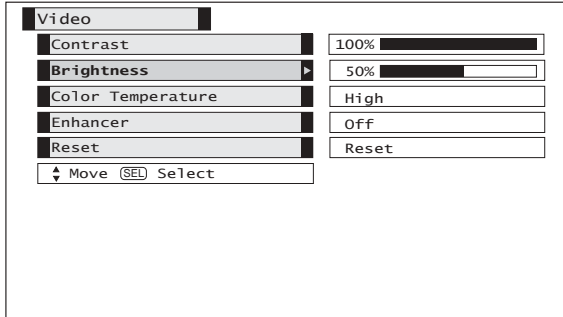

Use THUMB STICK ◀ or ▶ to adjust brightness. Press MENU button to return to RGB MODE MENU and EXIT to quit.

### COLOR TEMPERATURE

Use the CURSOR to change the COLOR TEMPERATURE. Set this to HIGH for cooler with more blue (9,300K), set to MEDIUM for more natural color (7,500K), or set to STANDARD for accurate color (6,500K), or Black/White (5,400K).

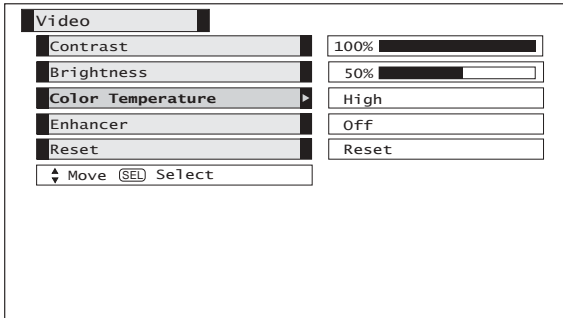

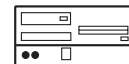

## ENHANCER

Enhances the picture detail.

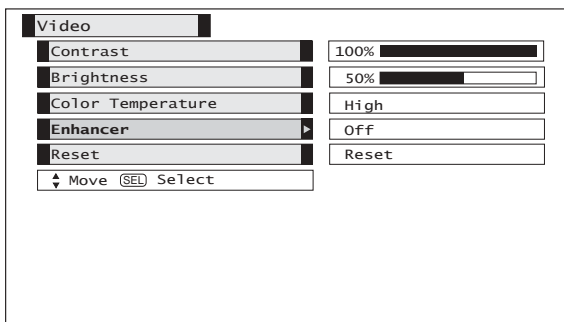

Use THUMB STICK ▲, ▼ to set ENHANCER Off, Low, Medium or High. Press SELECT button to ACCEPT and EXIT to quit.

## RESET

Set CONTRAST, BRIGHTNESS, COLOR TEMPERATURE, and ENHANCER to factory preset condition.

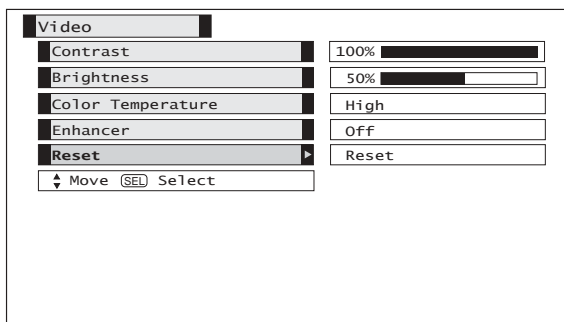

Press down on THUMB STICK to RESET to factory preset settings.

## ASPECT

Use this function to select the picture format aspect ratio while using RGB input.

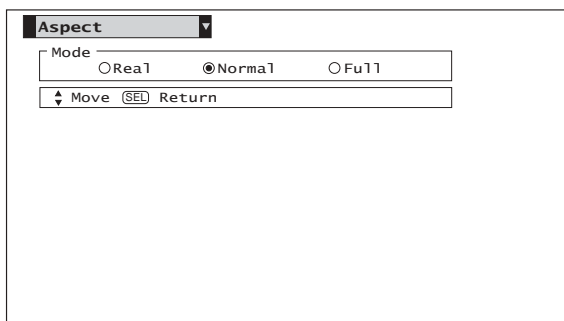

Use THUMB STICK ▲, ▼ to select Aspect Mode. Press SELECT button to set and EXIT button to quit.

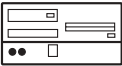

# RGB ON SCREEN DISPLAY

## AUTO ADJUST

HORIZONTAL POSITION, VERTICAL POSITION, HORIZONTAL CLOCK and CLOCK PHASE for current RGB format are adjusted automatically.

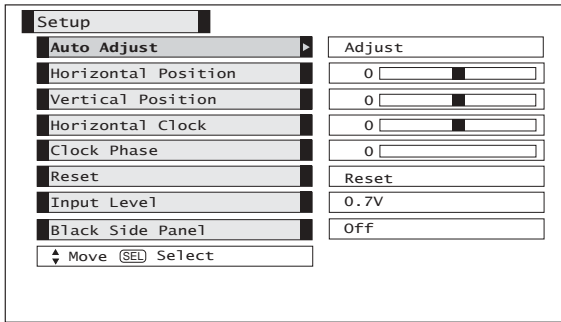

Press SELECT to select AUTO ADJUST.

- NOTE:**
- Press SELECT to AUTO ADJUST the RGB mode.
  - The other functions do not operate while AUTO ADJUST is in progress.
  - Allow the Plasma TV to warm up for 20 minutes before performing AUTO ADJUST.
  - Select a bright image for display while AUTO ADJUST takes place.
  - If AUTO ADJUST terminates unsuccessfully, try AUTO ADJUST again. If AUTO ADJUST fails several times in succession, try using manual adjustment to adjust Vertical Frequency, Aspect Ratio, Timing Frequency and Picture.
  - Always reset AUTO ADJUST when setting new display setting or when changing to a new external component.

## H POSITION

This feature allows you to adjust the horizontal position of the display.

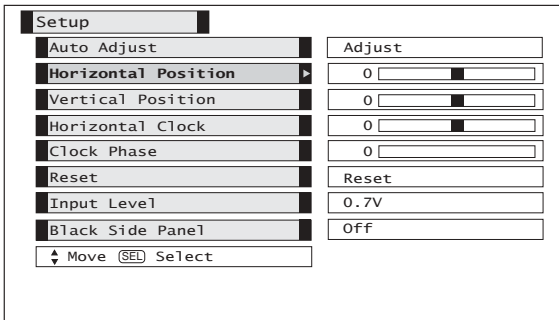

Use Left/Right cursors to adjust the horizontal position. Press the MENU button to return to previous menu item. Press EXIT to quit.

## V POSITION

This feature allows you to adjust the vertical position in RGB mode.

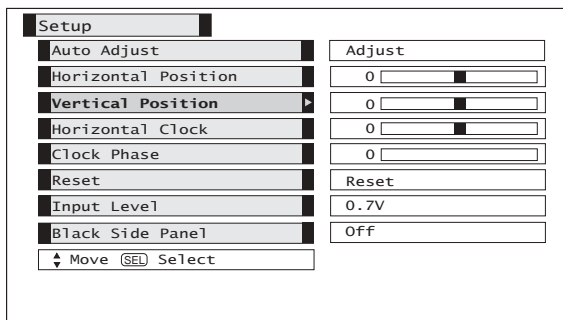

Use THUMB STICK ◀, ▶ to adjust the vertical position. Press MENU button to return to previous menu item. Press EXIT to quit.

# RGB ON SCREEN DISPLAY

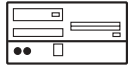

## HORIZONTAL CLOCK

Adjusts the pixel clock frequency to reduce the vertical stripe.

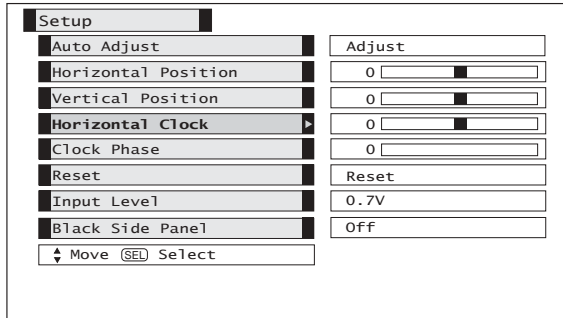

Use THUMB STICK ◀, ▶ to adjust the horizontal clock. Press the MENU button to return to previous menu. Press EXIT to quit.

**NOTE:** Due to varying signal content, you may see vertical or horizontal lines bend occasionally in RGB mode. However, this phenomenon is not a defect. It's caused by a lack of picture content due to under-scanning in RGB mode.

## CLOCK PHASE

Adjusts the phase to correct blurred or unstable images.

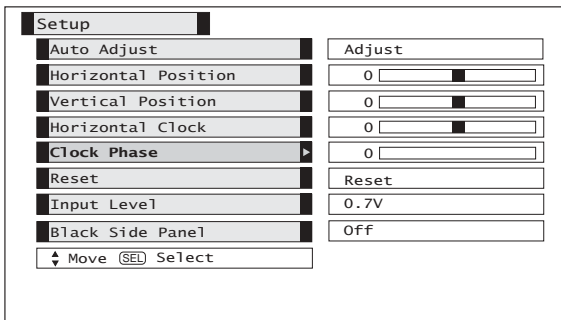

Use THUMB STICK ◀, ▶ to adjust the clock phase. Press the MENU button to return to previous menu item. Press EXIT to quit.

## RESET

Set HORIZONTAL POSITION, VERTICAL POSITION, HORIZONTAL CLOCK and CLOCK PHASE to factory preset, for current RGB format.

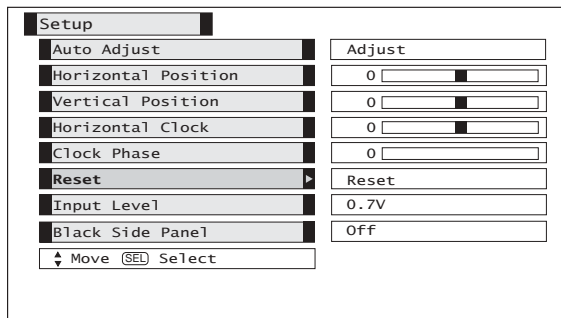

Press down on THUMB STICK to RESET to factory preset settings.



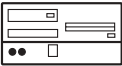

# RGB ON SCREEN DISPLAY

## RGB ASPECT DISPLAY MODE.

ASPECT MODE AVAILABILITY	RGB (Analog) INPUT SIGNAL					
	Others	SVGA/XGA(4)	VGA	480p	720p	1080i
	X	REAL	REAL	REAL(1)	X	X
	NORMAL	NORMAL	NORMAL	NORMAL(1)	X	X
	FULL	FULL	FULL	FULL(1)	FULL(2,3)	FULL(2,3)

For numbers in ( ), please see corresponding note below.

- NOTES:**
1. Lack of raster can be seen in RGB when a 480p signal is input.
  2. AUTO ADJUST function (see page 74) is not available in 720p, 1080i, and 480p input signal.
  3. FULL aspect mode, only 95% of information can be displayed (5% is treated as overscan).
  4. 50" only.

## INPUT LEVEL

Select the Input Level voltage between 0.7V and 1.0V.

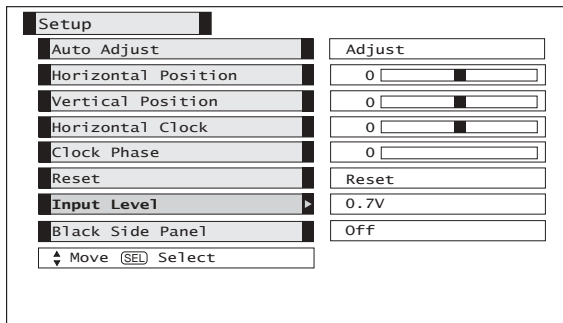

Use THUMB STICK ◀, ▶ to select between 0.7V and 1.0V depending on the amount of brightness in the picture.

## BLACK SIDE PANEL

The BLACK SIDE PANEL function turns the gray side bars ON/OFF when watching Aspect in Real and Normal signals in Standard Mode.

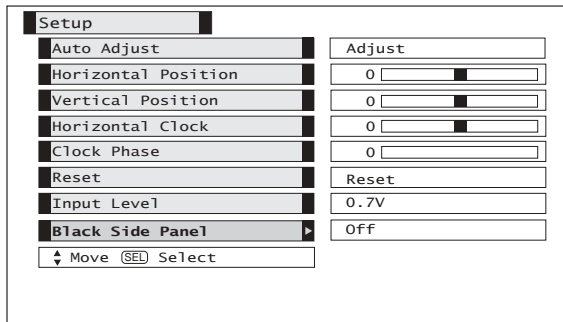

Press down on THUMB STICK to select BLACK SIDE PANEL ON/OFF.

- NOTE:** To prevent the plasma phosphor from burning when watching Aspect in Real and Normal signal, turn off the BLACK SIDE PANEL. It is recommended to watch 4:3 signal with gray side bar.

## POWER SWIVEL

Controls the motorized stand for 32"/42" displays.

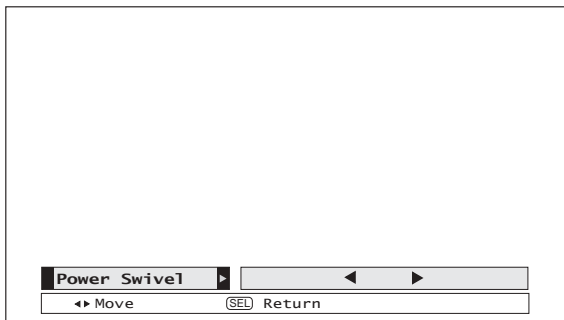

Use THUMB STICK ▶ to rotate the TV to the right. Use THUMB STICK ◀ to rotate the TV to the left. Release the THUMBSTICK to stop rotation.

- NOTES:**
1. The Power Swivel has a maximum turning radius of 30° (left and right).
  2. Do not place any objects on the path of the monitor when using the power swivel feature.
  3. Before using the power swivel feature, please make sure that the path of the monitor is clear of any fingers, hands or any other body parts to avoid causing injury.

# CARE OF YOUR HITACHI PLASMA DISPLAY AND YOUR REMOTE CONTROL



## DO

Dust the screen and frame with a cleaning cloth from the accessories pack.

Clean the screen and frame with a soft cloth moistened in warm water and dry with a soft cloth. A mild soap may be used if the screen is extremely dirty.

Place your Plasma Television away from extreme heat, humidity, and extremely dusty places.

Remove the plug (AVC Center/Display Monitor) from the wall outlet if your Plasma Television will not be used for a long period of time, for instance, when you go on vacation.

## DO NOT

Do not clean your screen with strong cleaners, polishes or a chemically treated cloth.

Do not place rubber or vinyl products or cellophane tape on your Plasma Television.

Avoid repeatedly touching the screen.







Do not subject the remote control to shocks such as dropping it on the floor, etc. This may cause physical damage to the precision parts.

Avoid placing the remote control in a high humidity place or getting it wet. Do not leave it on or near a heater. Excessive heat or moisture may cause the remote control unit to fail.

When the batteries run down, remote control operation will become erratic or become unresponsive. Replace the old batteries with two new "AA" or "AAA" size batteries. Do not use an old battery with a new battery.

Exposing the screen to direct sunlight for a long period of time or heat may cause damage to the plasma screen.

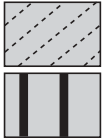

	<ul style="list-style-type: none"> <li>• <b>IGNITION NOISE:</b> Black spots or horizontal streaks may appear, picture may flutter or drift. Usually caused by interference from automobile ignition systems, neon lamps, electrical drills, and other electrical appliances.</li> </ul>
	<ul style="list-style-type: none"> <li>• <b>GHOSTS:</b> Ghosts are caused by the television signal following two paths. One is the direct path and the other is reflected from tall buildings, hills or some other objects. Changing the direction or position of the antenna may improve reception. Ghosting may also be caused by defects in the antenna system such as unshielded leads or connecting several sets to the same antenna without using multiple antenna couplers.</li> </ul>
	<ul style="list-style-type: none"> <li>• <b>SNOW:</b> If your receiver is located in the fringe area of a television station where the signal is weak, your picture may be marred by the appearance of small dots. When the signal is extremely weak, it may be necessary to install a special antenna to improve the picture.</li> </ul>
	<ul style="list-style-type: none"> <li>• <b>RADIO FREQUENCY INTERFERENCE:</b> The interference produces moving ripples or diagonal streaks, and in some cases, causes loss of contrast in the picture.</li> <li>• <b>PREVENTION OF AN OBSTACLE TO RADIO RECEIVERS</b> This monitor has been designed pursuant to the FCC class B Rules. This is to prevent a problem to Radio receivers. If this monitor causes a problem to Radio receivers, then take the following steps: <ul style="list-style-type: none"> <li>- Keep the monitor away from Radio.</li> <li>- Adjust Radio antennas in order for the monitor not to receive interference.</li> <li>- The antenna cable of Radio should be kept away from the monitor.</li> <li>- Use a coaxial cable for antenna.</li> </ul> </li> </ul> <p>You can check if this monitor influences Radio receivers by turning off all other equipment other than the monitor.</p> <p>If you find a problem receiving Radio when using the monitor, check the instructions mentioned above.</p>
<ul style="list-style-type: none"> <li>• The display image appears scrolling diagonal.</li> <li>• Text displayed across the screen appears vertically streaked, with the characters in vertical columns blurred.</li> </ul> 	<ul style="list-style-type: none"> <li>• Adjust the horizontal clock and clock phase. (Adjust the horizontal clock first, the clock phase next.) (RGB input)</li> </ul>
<ul style="list-style-type: none"> <li>• Text displayed across the screen appears blurred.</li> <li>• A fine pattern flickers when displayed on the screen.</li> </ul> 	<ul style="list-style-type: none"> <li>• Adjust the clock phase for the clearest viewing. (RGB input)</li> </ul>
<ul style="list-style-type: none"> <li>• Vertical stripes appear, depending on the screen contents.</li> </ul>	<ul style="list-style-type: none"> <li>• The plasma display panel is lighting the phosphors by the discharge of internal radiation. Depending on the screen contents, in rare cases this may cause vertical stripes to appear because of failure to light. Please note that this is not a malfunction.</li> </ul>
<ul style="list-style-type: none"> <li>• Coarse horizontal stripes appear in FULL display.</li> </ul>	<ul style="list-style-type: none"> <li>• Adjusting the clock phase will reduce the horizontal stripes. (RGB input)</li> </ul>
<ul style="list-style-type: none"> <li>• The display dims to make the picture invisible during special playback of a VCR (FF, REW).</li> </ul>	<ul style="list-style-type: none"> <li>• This condition may occur when the unit is connected to a VCR with component output, such as 480i, but it is not a failure. But when it occurs, switch to composite output or S1 (S2) output).</li> </ul>



SYMPTOMS	CHECK THESE ITEMS AND TRY THESE ADJUSTMENTS												
	Be sure external connection is correct	Be sure power cord is plugged in	Be sure TV is switched "ON"	Try another channel (station trouble)	Check antenna connections (back of TV)	Check outside antenna	Check for local interference	Adjust Contrast control	Adjust Brightness control	Adjust Color control	Adjust Tint control	Adjust Volume control	Check power swivel cable (back of TV)
No Picture, no sound	●	●	●	●	●	●	●						
Sound OK, picture poor	●			●	●	●	●	●	●				
Picture OK, sound poor	●			●	●	●	●	●				●	
Picture blurred	●			●	●	●	●	●					
Lines or streaks in picture				●	●	●	●	●					
Poor reception on some channels				●	●	●	●	●					
Picture rolls vertically				●				●					
No color	●			●	●	●	●			●			
Poor color	●			●	●	●	●			●	●		
Power Swivel not working													●



This Plasma Television complies with VESA DDC2B specifications, Plug & Play is a system with computer, peripherals (including monitors) and operating system. It works when the monitor is connected to a DDC ready computer that is running an operating system software that is capable for the plug & play.

When a Plug and Play PC is powered on, it sends a command to the Monitor requesting identification. The Monitor sends back a string of data including its characteristics.



## TRADEMARK ACKNOWLEDGMENT

DDC™ is a trademark of Video Electronics Standard Association.

IBM PC/AT and VGA are registered trademarks of International Business Machines Corporation of the U.S.A.

Apple and Macintosh are registered trademarks of Apple Computer, Inc.

VESA is a trademark of a nonprofit organization, Video Electronics Standard Association.



This Class B digital apparatus meets all requirements of the Canadian Interference-Causing Equipment Regulations.

This Class B digital apparatus complies with Canadian ICES-003.

Cet appareil numérique de la classe B est conforme à la norme NMB-003 du Canada.

Cable Compatible Television Apparatus- Télévision câblocompatible, Canada.

### Notes on Closed Caption:

This Plasma Television receiver will display television closed captioning, (  or  ), in accordance with paragraph 15.119 of the FCC rules.



## AGENCY REGULATORY INFORMATION

### Federal Communications Commission Notice

This equipment has been tested and found to comply with the limits for a Class B digital device, pursuant to Part 15 of the FCC Rules. These limits are designed to provide reasonable protection against harmful interference in a residential installation. This equipment generates, uses and can radiate radio frequency energy and if not installed and used in accordance with the instructions, may cause harmful interference to radio communications. However, there is no guarantee that interference will not occur in a particular installation. If this equipment does cause harmful interference to radio or television reception, which can be determined by turning the equipment off and on, the user is encouraged to try to correct the interference by one or more of the following measures:

- Reorient or relocate the receiving antenna.
- Increase the separation between the equipment and the receiver.
- Connect the equipment into an outlet on a circuit different from that to which the receiver is connected.
- Consult the dealer or an experienced radio/television technician for help.

### Modifications

The FCC requires the user to be notified that any changes or modifications made to this device that are not expressly approved by Hitachi Home Electronics (America), Inc. may void the user's warranty.

### Cables

Connections to this device must be made with shielded cables with metallic RFI/EMI connector hoods to maintain compliance with FCC Rules and Regulations.

Any cables that are supplied with the system must be replaced with identical cables in order to assure compliance with FCC rules. Order Hitachi spares as replacement cables.

### Declaration of Conformity

This device complies with Part 15 of the FCC Rules. Operation is subject to the following two conditions: (1) this device may not cause harmful interference and (2) this device must accept any interference received, including interference that may cause undesired operation.

For questions regarding this declaration, contact:

Hitachi America, LTD.  
Home Electronics Division  
900 Hitachi Way  
Chula Vista, CA 91914-3556  
Tel. 1-800-448-2244 (1-800-HITACHI)  
ATTN: CUSTOMER RELATIONS



## Features:

- New Easy-to-Use On-Screen Menu Control (3 Language)
- New AV Network System Control
  - Control up to 4 components with one remote
  - 2 IR Mouse cables included
  - Control Codes Stored in AV Control Center
- Two Tuner Split Screen except RGB modes.
- Illuminated and Preprogrammed Remote Control
- Power Management: ON/OFF via signal detection
- Menu Control Keys accessible from AV Control Center
- Picture Enhancement
- Input Signal Identification
- Extra Simple Remote Control for easy basic functions
- Power Swivel stand for 32"/42".

## Video:

- 1280 x 768 Display Resolution (50")
- 1024 x 1024 Display Resolution (42")
- 852 x 1024 Display Resolution (32")
- ALiS (Alternate Lighting of Surfaces Technology) (32",42")
- High-Contrast Pure-Color Glass Shield
- Wide Viewing Angle: More than 160°
- 4 Color Temperature Presets: Black/White-5400K, Standard-6500K, Medium-7500K, High-9300K.
- Multiple Screen Fill Modes (4:3 Standard/Expanded/Zoom1/Zoom2/16:9 Standard/Zoom)<sup>1</sup>
- 4MB 10-bit 3D Y/C Comb Filter
- Picture Modes (Day and Night)
- Computer Display: VGA, (SVGA, XGA, SXGA-scaled)

## Inputs:

- Power Input . . . . .AC 120V, 60Hz
- Power Consumption
  - Refer to rear panel at the back of the Plasma Monitor and AVC Center
- Antenna input impedance . . . . .75 Ohm
- Channel coverage . . . . .181ch.
  - VHF-Band . . . . .2 ~ 13
  - UHF-Band . . . . .14 ~ 69
  - CATV Mid Band . . . . .A-5 ~ A-1
  - . . . . .A-I
  - Super Band . . . . .J-W
  - Hyper Band . . . . .W+1 - W+28
  - Ultra Band . . . . .W+29 - W+84
- Video . . . . .1.0Vp-p, 75 Ohm
- S-Video
  - Luminance (Y) . . . . .1.0Vp-p, 75 Ohm
  - Chrominance (C) . . . . .0.286Vp-p, 75 Ohm
- Component Video
  - Luminance (Y) . . . . .1.0Vp-p, 75 Ohm
  - Chrominance (P<sub>B</sub>/P<sub>R</sub>) . . . . .0.7Vp-p, 75 Ohm
- Audio input Impedance . . . . .47k Ohm
- Average input level . . . . .470mVrms
- RGB . . . . .0.7Vp-p, 75 Ohm

## Outputs:

- Video . . . . .1.0Vp-p, 75 Ohm
- Audio . . . . .470mVrms, 1k Ohm

## Audio:

- MTS Stereo/SAP
- TruBass and Matrix Surround
- 10W+10W (42HDX60/50HDX60)
- 7W+ 7W (32HDX60)
- Soft Mute (50% and 100%)

## Supplied Accessories:

- Illuminated Preprogrammed Remote Control
- Batteries
- 9' Monitor Connection Cable
- 6' AC Cable (2)
- Subwoofer Cable
- IR Mouse Cable
- Speaker Accessories (42"/50")
- Refer to page 4 for complete list.

## Optional Accessories:

- 42" stand, 32" stand
- Wall Mount Bracket

## INPUTS/OUTPUTS

• Inputs: . . . . .	RGB, VIDEO 1-5
• Wideband Component Y, Pb,Pr . . . . .	2
• RGB: Analog Input . . . . .	1
• Composite Video . . . . .	4
• S-Video . . . . .	3
• Antenna (RF) Inputs . . . . .	2
• Converter Box Output . . . . .	1
• Audio Output . . . . .	1
• Monitor Output . . . . .	1
• Headphone Output . . . . .	1
• Subwoofer Output . . . . .	1
• DVI-HDTV . . . . .	1

## SPECIFICATIONS

- Multi-Scanning: . . . . .24-109kHz (h), 50-85Hz (v)
- Pixel Pitch(50HDX60) . . . . .0.86(horiz.) x 0.81(vert.) mm
- Pixel Pitch(42HDX60) . . . . .0.90(horiz.) x 0.51(vert.) mm
- Pixel Pitch(32HDX60) . . . . .0.84(horiz.) x 0.39(vert.) mm
- FCC class: . . . . .B for Consumer Use
- Power Requirements: . . . . .108-132V, 60Hz

## DIMENSIONS

Monitor without stand and speakers (42" and 50")

	32"	42"	50"
• Width	38 7/16"	40 9/16"	48
• Height	19 3/16"	25 1/16"	28 1/8
• Depth	3 3/4"	3 3/4"	4 1/8
• Weight	58 lbs.	86 lbs.	108 lbs.

## Audio Video Control Center

- Width . . . . .16 15/16"
- Height . . . . .3 3/8"
- Depth . . . . .9 1/2"
- Weight . . . . .9 lbs.

<sup>1</sup> Screen mode availability varies by input format

HDTV Monitors display HDTV when combined with an HDTV Tuner and Source. All specifications, weights, and dimensions are subject to change without prior notice. Please access [www.hitachi.com/tv](http://www.hitachi.com/tv) for detailed specifications and dimensions for custom installations.

UltraVision Digital is a registered trademark of Hitachi Home Electronics (America), Inc.

TruBass and the SRS (●)® symbol are trademarks of SRS Labs, Inc. TruBass technology is incorporated under license from SRS Labs, Inc.



# HITACHI

*Service  
hotline*

To locate an authorized  
HITACHI service facility  
in the continental U.S.A.  
and Canada,

**DIAL TOLL FREE**

7 days a week, 24 hours a day

**800 HITACHI**  
**(1-800-448-2244)**

## **Hitachi America, LTD. Home Electronics Division**

Hitachi has made every effort to assure you hours of trouble free operation from your unit. However, should you require service, a network of Hitachi Authorized Service Facilities has been established in all 50 states and Puerto Rico. Each facility will provide you with convenient and expedient assistance. Our service hotline operator will direct you to the Hitachi Authorized Service Facility nearest you. Just present proof of purchase and/or delivery receipts to the Hitachi Authorized Service Facility, and service will be rendered in accordance with the terms of the limited warranty as stated on your warranty card or operating guide.

***Should you have any questions regarding warranty, service, operation, or technical assistance, please contact:***

**Hitachi America, LTD.  
Home Electronics Division  
900 Hitachi Way  
Chula Vista, CA 91914-3556**





**Hitachi Canada, LTD.  
Digital Media Division**

*Should you have any questions regarding warranty, service, operation, or technical assistance, please contact:*

**In Canada:  
1-800-HITACHI  
(1-800-448-2244)**

**Monday - Friday EST 9:00am - 7:00pm  
Saturday EST 9:00am - 5:00pm**

*Look for your French Manual on the outside of the box.  
If the manual is missing, call*

**1-800-HITACHI  
(1-800-448-2244)**

*for a copy.*

*Pour de plus amples renseignements sur le service durant la période couverte par la garantie, sur le fonctionnement ou pour de l'assistance technique communiquez avec:*

**Au Canada:  
1-800-HITACHI  
(1-800-448-2244)**

**Lundi - Vendredi L'EST 9:00am - 7:00pm  
Samedi L'EST 9:00am - 5:00pm**

*La version française de votre manual se trouve à l'extérieur de la boîte.  
Si le manuel est manquant, coposez le*

**1-800-HITACHI  
(1-800-448-2244)**

*pour obtenir votre copie.*

**HITACHI CANADA, LTD.  
6740 Campobello Road  
Mississauga, ON L5N 2L8**



# INDEX

<b>A</b>	
Accessories, . . . . .	4
Antennas (Connecting), . . . . .	8
Aspect Ratio, . . . . .	29
Audio (Sound Enhancement)	
TruBass . . . . .	48
Audio Settings . . . . .	48
Audio Source . . . . .	48
Auto Adjust (RGB Input) . . . . .	74
Auto Noise Cancel . . . . .	48
A/V Network . . . . .	19-21,27-28
<b>B</b>	
Balance . . . . .	48
Bass . . . . .	48
Black Enhancement . . . . .	45
Black Side Panel . . . . .	63
Brightness . . . . .	45
<b>C</b>	
Caution and Safety Tips . . . . .	2-3
Channel Manager . . . . .	50-53
Channel Setup . . . . .	50
Auto Channel Scan . . . . .	51
Clock	
Phase . . . . .	74
Time . . . . .	61
Closed Captions	
Captions . . . . .	65
Color Management . . . . .	46
Color Decoding . . . . .	47
Color System . . . . .	63
Color Temperature . . . . .	45
Color . . . . .	45
Contrast . . . . .	45
Contrast Mode . . . . .	45
<b>E</b>	
Event Timer . . . . .	64
External Video Source . . . . .	13-18
<b>F</b>	
Favorite Channel . . . . .	30
Freeze . . . . .	34
<b>I</b>	
Input Setup . . . . .	62-63
Installation (Speakers/Monitor) . . . . .	5-6
<b>L</b>	
Language	
Menu Language . . . . .	59
Locks	
Change Access Code . . . . .	54
Channel Lock . . . . .	54
Locks (Continued)	
Front Panel Lock . . . . .	54
Input Lock . . . . .	54
Movie Ratings . . . . .	55
TV Ratings . . . . .	56
TV Ratings (Canadian - English) . . . . .	57
TV Ratings (Canadian - French) . . . . .	58
TV Time Out . . . . .	64
<b>M</b>	
Matrix Surround . . . . .	48
Menu Preference	
Language . . . . .	59
Background . . . . .	60
Monitor Out . . . . .	11
<b>N</b>	
Noise Cancel . . . . .	48
<b>P</b>	
Perfect Volume . . . . .	48
Picture Mode . . . . .	44
Picture-in-Picture (PIP) . . . . .	32-34
Position (RGB Input)	
Horizontal . . . . .	74
Vertical . . . . .	74
Power Swivel . . . . .	66, 76
<b>R</b>	
Remote Control	
Functions . . . . .	24-41
Programming Codes . . . . .	35-39, 41
Installing Batteries . . . . .	4
R/G/B . . . . .	30,67-76
<b>S</b>	
Screen Saver . . . . .	60
Sharpness . . . . .	45
Sound Enhancement . . . . .	48
Speakers . . . . .	48
Connecting External Speakers . . . . .	7,11,22
Internal . . . . .	48
Split Mode . . . . .	32
Stand . . . . .	4
Surf Button . . . . .	31
<b>T</b>	
Time . . . . .	61
Tint . . . . .	45
Treble . . . . .	48
<b>V</b>	
Video Settings . . . . .	44-47





**HITACHI**