

ST09-10C1 9.6" Liquid Crystal Display TV

This guide is designed as a reference to help you start using your LCD TV quickly. Please refer to the User's Manual for more detailed installation and safety instructions.

Front View

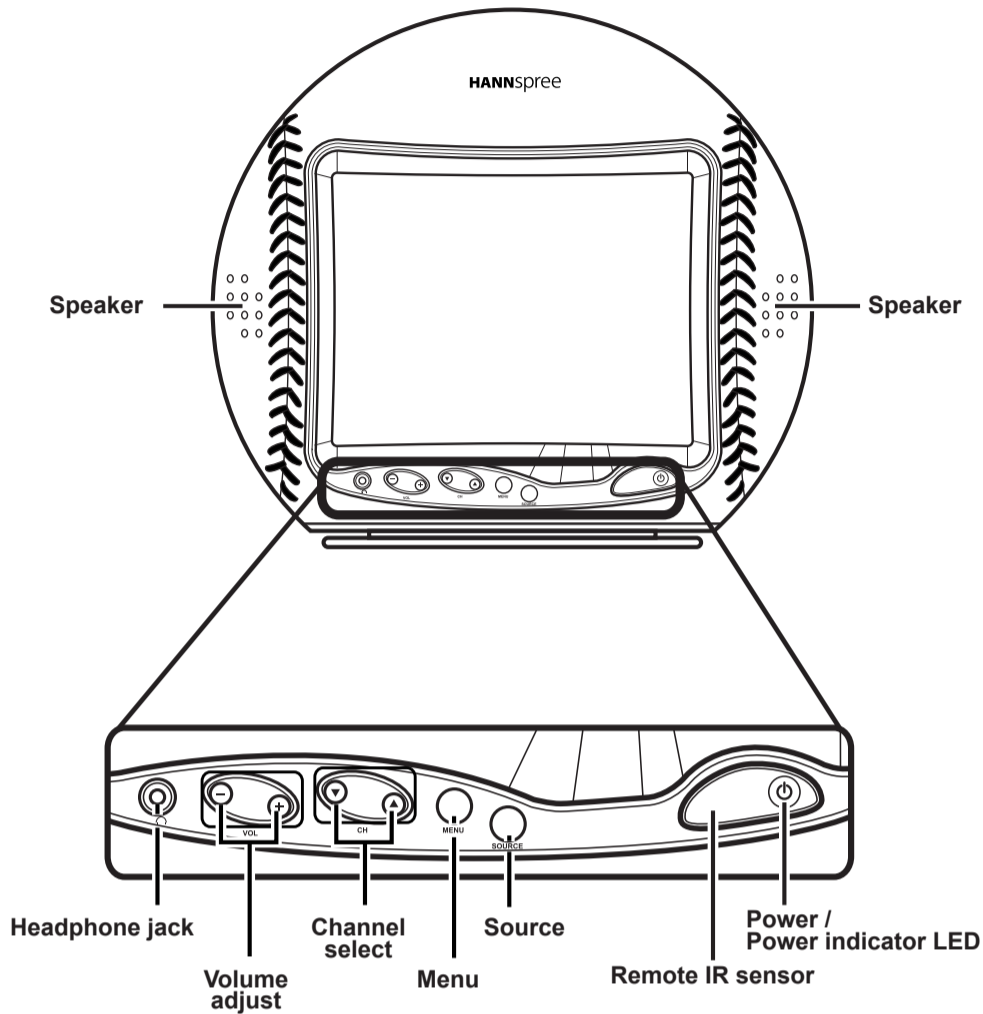

Rear View

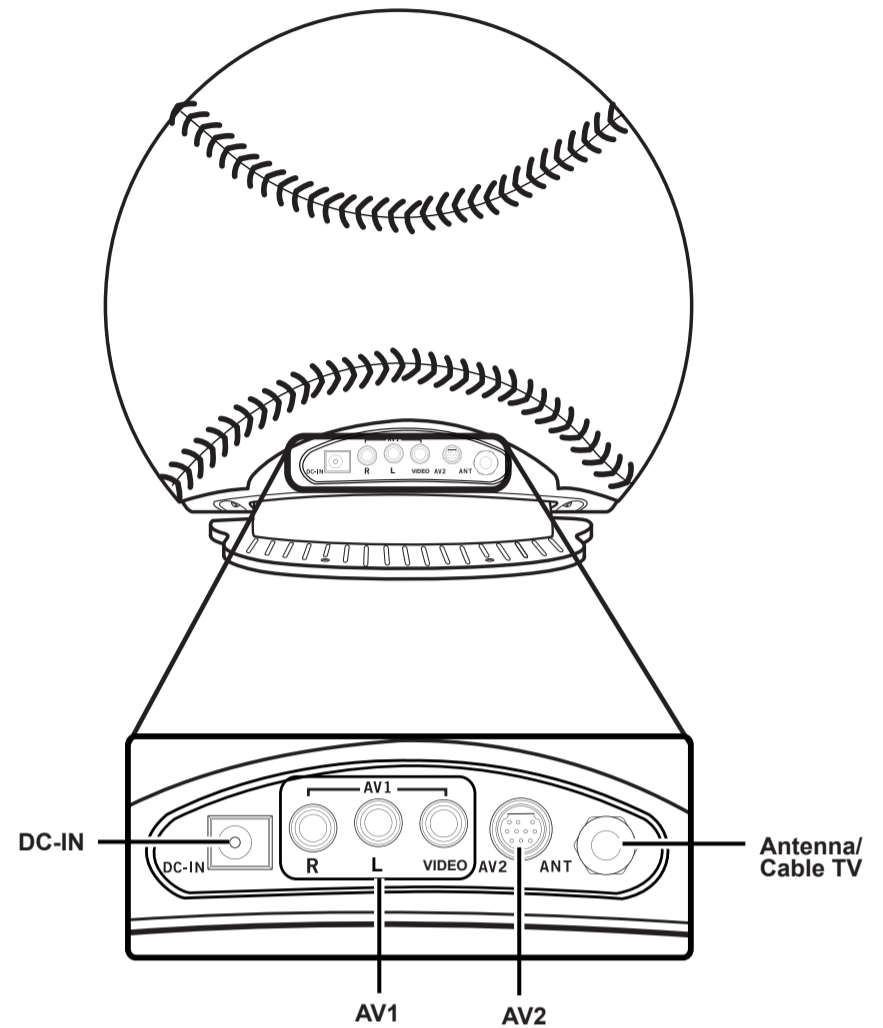

Making Connections

Connecting to Antenna/Cable TV

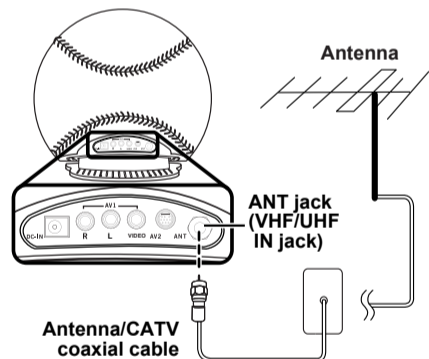

1. Connect one end of the VHF/UHF (Antenna) or CATV cable to ANT Jack (VHF/UHF IN Jack) on the back of the TV.
2. Connect the other end of the VHF/UHF (Antenna) or CATV cable to the Antenna or CATV socket.

Connecting to a VCR, VCD, DVD Player, or Video Game Console

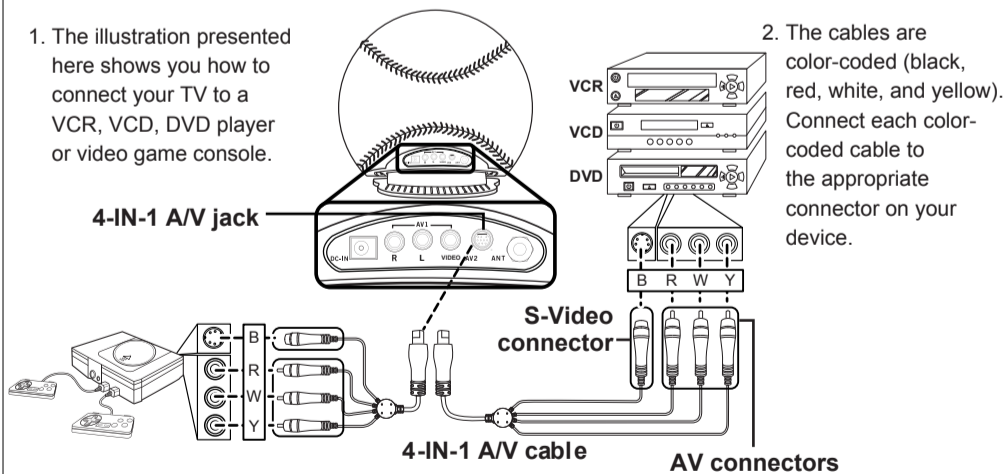

1. The illustration presented here shows you how to connect your TV to a VCR, VCD, DVD player or video game console.

2. The cables are color-coded (black, red, white, and yellow). Connect each color-coded cable to the appropriate connector on your device.

Connecting the Power Adapter

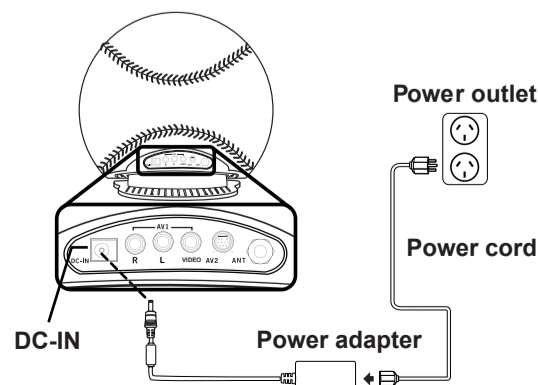

1. Connect the power cord to the power adapter as illustrated.
2. Plug the power adapter connector into the DC-IN input jack on the rear panel of the TV.
3. Insert the three-pronged plug at the other end of the power cord into a power outlet.

Note : Images are for illustration only and may vary by model or region.

A/V and Channel Setup

Selecting A/V Sources

1. Make sure your TV is turned on and a device such as a DVD player is connected.
2. Press the **SOURCE** button on the control panel to select different source signals. TV channel number, AV or AVs appear on the screen.

Note : AVs only appears on the screen when S-Video is connected.

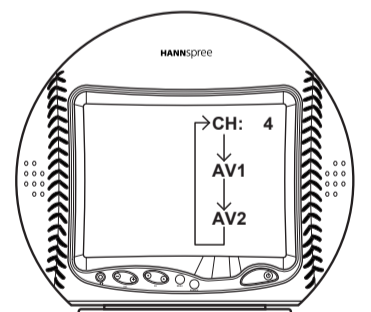

Auto Channel Setup

Please follow the instructions by using the control panel.

1. Press the **MENU** button to enter the OSD menu.
2. Use the **CH** button to select "TV".
3. Press the **VOL +** button to enter the TV setting.
4. Press the **CH** button until the "Auto Program" feature is selected.
5. Press the **VOL +** button to begin "Auto Program".
6. Your television will begin automatically memorizing the available channels.

Auto Program

