Contents

Introduction.....	1
Notational conventions	2
Important notes.....	2
Safety notes.....	2
Cleaning	4
Transport	4
Power cable.....	4
CE marking.....	4
Disposal and recycling	5
Preparing for use.....	5
Unpacking and checking the delivery.....	5
Preparing remove control	6
Inserting batteries.....	6
Replacing batteries.....	6
Removing the foot (when using a wall bracket).....	7
Installing plasma TV	8
Connections on plasma TV	9
Connecting plasma TV	12
Switching plasma TV on/off.....	13
Switching plasma TV on/into standby mode	13
Setting language of the OSD menu.....	14
Carrying out programme search.....	14
Adjusting programme settings.....	15
Arranging programmes.....	16
Changing programme properties.....	16
Deleting program.....	18
Selecting signal source	18
Changing programme.....	18
Operation.....	19
Operating elements on the device.....	19
Changing the device settings with the buttons of the control panel	20
Remote control	21
Teletext.....	22
Buttons for editing programme list.....	22
PIP (Picture in Picture).....	22
Changing device settings with remote control.....	23
Description of menus.....	23
PICTURE menu - picture settings	24
SOUND menu - sound settings	25
SETUP menu - advanced settings	27
TIME menu - time settings	29
TV menu - programme settings.....	30
Display modes.....	31
Main display mode	31
PIP mode (Picture in Picture).....	32

Contents

Technical data	33
VESA-DDC-compatible VGA interface	35
Preset operating modes (PC)	35
Power consumption	35
PC Analogue (D-SUB)	36
PC Digital (DVI-D).....	36
SCART (Half/Full)	37
S-Video	37
Colour and transmission system by country	38
Troubleshooting	40

Introduction

Your new plasma TV MYRICA P42-1AH / P42-2H / P50-2H possesses a whole range of useful features and functions, e.g.:

- analogue tuner for VHF, UHF and cable programmes
- connections for SCART (video and RGB), video and S-Video
- minimal space requirements thanks to slim casing
- optimum ergonomic characteristics (totally distortion-free and colour purity right into the corners)
- high degree of brightness and good contrast
- high resolution for operation on a PC
- easy-to-operate remote control
- convenient operation via integrated OSD (On-Screen-display) menu
- 2 tuner picture in picture
- picture size changeover: full-screen, panorama, zoom 1 and zoom 2
- power management for reducing power consumption when the computer is not in use
- integrated dual-channel loudspeakers
- integrated NICAM/IGR sound decoder for stereo and two-channel sound
- automatic switch-off function
- teletext

This operating manual contains important information you require to start up and run your device.

For TV operation with the integrated tuner, a terrestrial antenna or a cable connection is required. As an alternative, a satellite receiver can be connected to one of the SCART jacks.

When you put the device into operation for the first time, you should carry out a programme search (see "Preparing for use").

Target group

You don't need to be an "expert" to perform the operations described here. Do, however, read the "Important notes" chapter in the operating manual of the computer and in this operating manual.

In the event of any problems occurring, please contact your sales outlet or our help desk.

Additional information

Details of how you set the resolution and refresh rate are provided in the documentation on your screen controller/the associated driver software.

Notational conventions

The meanings of the symbols and fonts used in this manual are as follows:



Pay particular attention to text marked with this symbol. Failure to observe this warning endangers your life, destroys the device, or may lead to loss of data.



Supplementary information, remarks, and tips follow this symbol.

► Text which follows this symbol describes activities that must be performed in the order shown.

"Quotation marks" indicate names of chapters or terms.

Texts in italics indicate filenames and menu items.

Important notes

In this chapter you will find information regarding safety which is essential to take note of with your plasma TV.



Avoid still images on the screen for longer periods, e.g. still images from videos, sender label etc. (maximum of 1 hour).

This pictures may remain visible! Also avoid longer operation in a picture mode in which black bars are visible (operation in the 4:3 picture format). These black bars can also remain visible.



This product from Fujitsu Siemens Computers contains intellectual property of third parties. Any tampering with or modification of the product will void the warranty and may lead to legal prosecution to the full extent of the law.

Safety notes

This device meets the relevant safety requirements for audio, video and TV devices.

If you have any questions, contact your sales outlet or our help desk.

- The display surface of the plasma TV is sensitive to pressure and scratches. You should therefore be careful with the display surface so as to avoid lasting damage (Newton rings, scratches).
- If the device is brought into the installation site from a cold environment, condensation can form. Before operating the device, wait until it is absolutely dry and has reached approximately the same temperature as the installation site.
- During installation and before operating the device, please observe the instructions on environmental conditions in the "Technical data" chapter as well as the instructions in the "Preparing for use" chapter.

- To ensure sufficient ventilation, the intake and exhaust air openings of the device must never be blocked.
- The device automatically sets itself to the correct voltage within the range from 100 V to 240 V. Ensure that the local mains voltage lies within these limits.
- This device may only be connected to a grounded socket.
- Ensure that the power socket on the device or the earthed mains outlet is freely accessible.
- The ON/OFF switch does not disconnect the device from the mains voltage. To completely disconnect the mains voltage, remove the power plug from the socket.
- Lay all cables so that nobody can stand on them or trip over them. When attaching the device, observe the relevant notes in the "Preparing for use" chapter.
- No antenna or data transfer cables should be connected or disconnected during a thunderstorm.
- Make sure that no objects (e.g. jewellery chains, paper clips, etc.) or liquids get inside the device (danger of electric shock, short circuit).
- Objects filled with liquids, e.g. vases, must not be placed on the device. The device is not waterproof! Protect the device from spray water (rain, sea water).
- In emergencies (e.g. damaged casing, elements or cables, penetration of liquids or foreign matter), switch off the unit, disconnect the power plug and contact your sales outlet or our help desk.
- The device must be disposed of in accordance with the local regulations for disposal of special waste. During handling and disposal, the safety regulations applicable to fluorescent materials must be observed.
- Only qualified technicians should repair the device. Unauthorised opening and incorrect repair may greatly endanger the user (electric shock, fire risk).
- You may set only those resolutions and refresh rates specified in the "Technical data" chapter. Otherwise you may damage your monitor. If you are in any doubt, contact your sales outlet or our help desk.
- Use a screen saver with moving images in PC mode and activate the power management for your monitor to prevent still images from "burning in".
- Keep this operating manual together with your device. If you pass on the device to third parties, you should include this manual.

Cleaning

- Remove the power plug before cleaning the device.
- Do not clean any interior parts yourself, leave this job to a service technician.
- Do not use any cleaning agents that contain abrasives or may corrode plastic.
- Ensure that no liquid will run into the system.
- Ensure that the ventilation areas of the device are free.
- The display surface of the device is sensitive to pressure and scratches. Clean it only using a soft, slightly moistened cloth.

Wipe the device casing with a dry cloth. If the monitor is particularly dirty, use a cloth which has been moistened in mild domestic detergent and then carefully wrung out.

Transport

- Transport the device with care and only in its original packaging or another corresponding packaging to protect it from knocks and jolts.
- Never drop the device (danger of glass breakage).

Power cable

To guarantee safe operation, use the cable supplied. Use the following guidelines if it is necessary to replace the original cable set.

- The female/male receptacles of the cord set must meet IEC60320/CEE-22 requirements.
- The cable has to be HAR-certified or VDE-certified. The mark HAR or VDE will appear on the outer sheath.
- For devices which are mounted on a table, type SVT or SJT cable sets may be used. For devices which sit on the floor, only SJT type cable sets may be used.
- The cable set must be selected according to the rated current for your device.

CE marking

 The shipped version of this device complies with the requirements of the EEC directives 89/336/EEC "Electromagnetic compatibility" and 73/23/EEC "Low voltage directive".

Disposal and recycling

This device has been manufactured to the highest possible degree from materials which can be recycled or disposed of in a manner that is not environmentally damaging. The device may be taken back after use to be recycled, provided that it is returned in a condition that is the result of normal use. Any components not reclaimed will be disposed of in an environmentally acceptable manner.

If you have questions on disposal, please contact your point of sale, our Help Desk or obtain information at: www.fujitsu-siemens.com/recycling

Preparing for use

Unpacking and checking the delivery



The display surface of the device is sensitive to pressure and scratches. Always hold the device by the casing!

- ▶ Unpack all the individual parts.
- ▶ Check the delivery for damage incurred during transportation.
- ▶ Check whether the delivery agrees with the details in the delivery note.
The complete device package includes:
 - one plasma TV
 - one power cable
 - one remote control
 - two batteries type AAA
 - one Warranty Booklet
 - one "Getting Started" manual (two volumes)
 - this operating manual (two volumes)

Should you discover that the delivery does not correspond to the delivery note, notify your local sales outlet immediately.



We recommend that you keep the original packaging material. Keep it for future transportation.

Preparing remove control

Inserting batteries

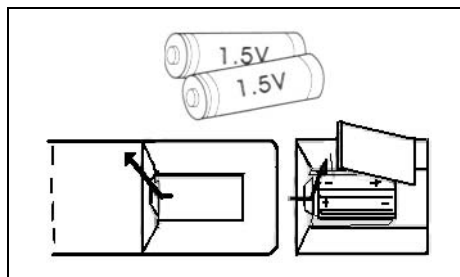

- ▶ Open the back cover of the remote control by sliding it in the direction of the arrow.
- ▶ Place the batteries supplied in the battery compartment. Ensure correct polarity.
- ▶ Close the battery compartment by sliding the cover back on until you hear and feel it click into place.



Remove the batteries when not using the remote control for longer periods.
Handle the remote control with care. Do not drop the remote control on the floor.
Do not expose the remote control to moisture, direct sunlight or high temperatures.

Replacing batteries

- ▶ When the batteries are used up (indicator no longer lights up), replace them with two batteries of the same type (type AAA).



Do not throw batteries or accumulators into the household waste. Batteries or accumulators must be disposed of in accordance with local regulations concerning special waste.

Removing the foot (when using a wall bracket)

Before you can use a wall bracket, the foot must first be removed:



The wall bracket is not included in the consignment of the TV.

The foot is shown as an example in the following illustrations. The delivered foot may differ from the illustration.

- ▶ Carefully lay the plasma TV on a smooth, clean work surface with the front facing downward. Ask someone to help you.



Even small knocks can damage the device.

Make sure that no objects are lying on the work surface, as otherwise the frame or display surface could be damaged.

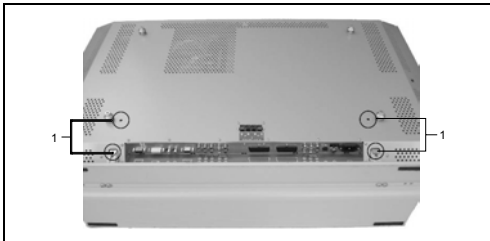

- ▶ Remove the four screws (1) that secure the foot to the device.

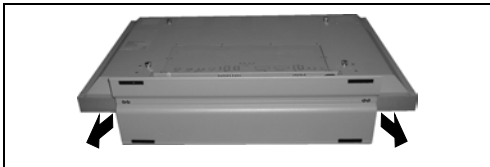

- ▶ Pull the foot away from the device.
- ▶ Mount the wall bracket as described in the wall bracket documentation.

Installing plasma TV

Ventilation



To ensure sufficient ventilation, the intake and exhaust air openings of the device must never be blocked.

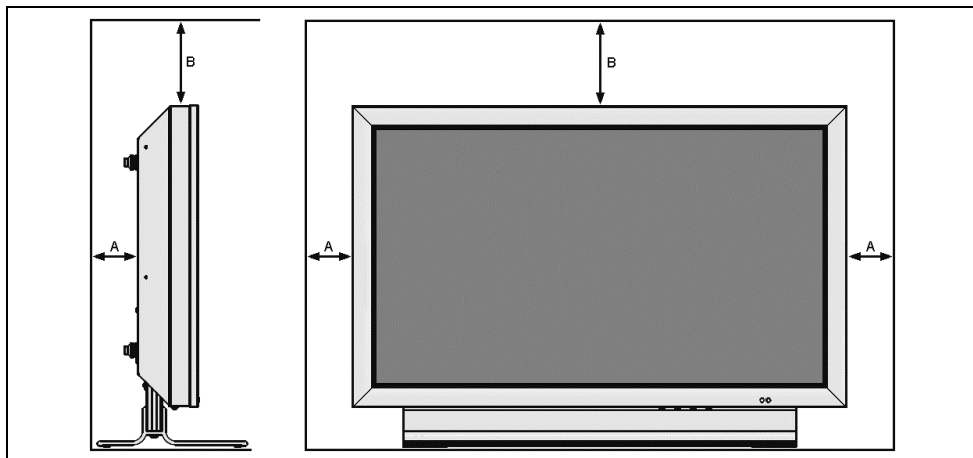

When installing the TV in niches, maintain the minimum distance for sufficient ventilation of the device: 10 cm from the side and back, 20 cm from the top.

Connections on plasma TV



Observe the safety precautions in the "Important notes" chapter in this operating manual.

Do not cover the ventilation openings of the monitor.

Never open the housing of the power supply unit. There is extreme danger from an electrical shock with the housing open. There are no components requiring cleaning or repairs in the interior.

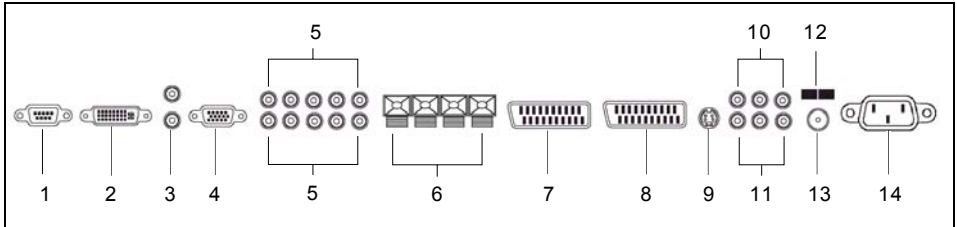

1 = RS-232 port

2 = DVI port

3 = AUDIO ports (LINE)

4 = PC-IN port (VGA)

5 = COMPONENT ports (2x)

6 = Loudspeaker ports

7 = SCART1 port (Half)

8 = SCART2 port (Full)

9 = S-VIDEO port

10 = AV ports (OUT)

11 = AV ports (IN)





12 = ON/OFF switch



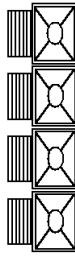

13 = Antenna port

14 = Power connector

The following devices can be connected to this plasma TV:

	RS-232 (black)	Serial port For customer service, e.g. for updating the firmware
	DVI IN (white)	Connection for digital video input signals e.g. a PC with a digital output (DVI-D) or for HDTV devices
	AUDIO IN white (left) red (right)	Connection for audio input signals (LINE IN) e.g. for a PC or for HDTV devices

	<p>PC IN (blue)</p>	<p>Connection for analogue VGA input signals e.g. for a PC with an analogue output (D-SUB)</p>
	<p>COMPONENT 1 COMPONENT 2 Y - green Pb - blue Pr - red AUDIO white (left) red (right)</p>	<p>Connections for component video and audio input signals e.g. for HDTV decoder, HDTV video recorder or HDTV player</p>
	<p>SPEAKER red/right/+ black/right/- black/left/- red/left/+</p>	<p>Connection terminals for external loudspeakers</p>
	<p>SCART 1 (Half)</p>	<p>Connection for AV (CVBS) and audio input signals e.g. for satellite receiver, DVD player, video recorder, decoders or a gaming console</p>
	<p>SCART 2 (Full)</p>	<p>Connection for AV (CVBS, RGB) and audio input signals e.g. for satellite receiver, DVD player, video recorder, camcorder or a gaming console</p>

	S-VIDEO IN	Connection for S-VIDEO input signals e.g. for DVD player, video recorder or film camera with S-Video connection
	AV: VIDEO yellow AUDIO white (left) red (right)	Connections for video and audio input signals e.g. for DVD player, video recorder, film camera with video port or gaming console
	TV-ANT.	antenna cable port
	AC INPUT	Connector for the power cable

Connecting plasma TV

Connecting antenna

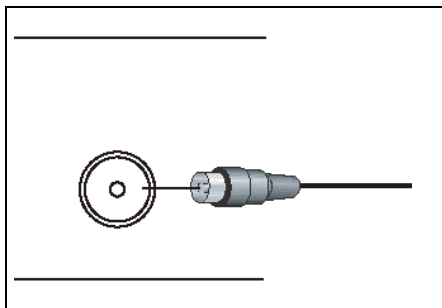

- ▶ Connect an antenna cable to the antenna connection of the plasma TV and to the TV antenna socket.

Connecting the power supply

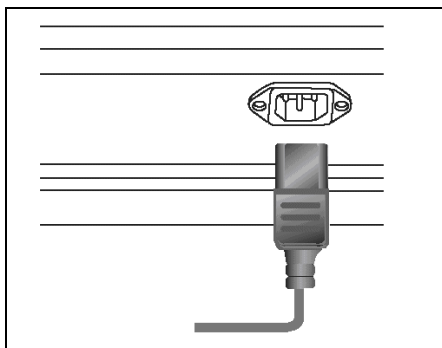

- ▶ Plug the power cable supplied into the power connector of the plasma TV.
You will find the power connector on the back of the plasma TV.
- ▶ Connect the connector of the power cable supplied into a properly earthed mains outlet and ensure a secure connection.

Switching plasma TV on/off

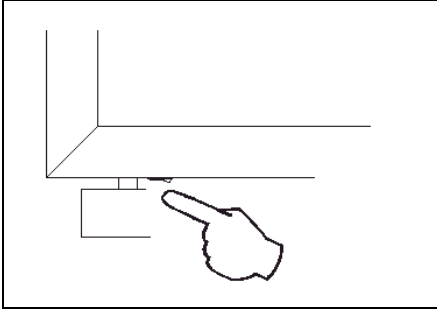

- ▶ Press the ON/OFF switch at the left on the back of the plasma TV.

Switching plasma TV on/into standby mode

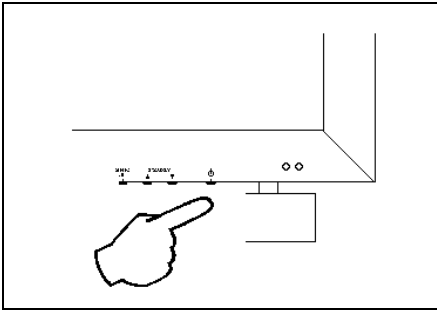

- ▶ Press the Standby button at the right on the underside of the plasma TV.

From the indicator at the lower right on the front of the plasma TV you can recognise whether the device is in operation, in the standby mode or switched off.





- Green = The device is switched on.
- Red = The device is in standby mode.
- Dark = The device is switched off.

Setting language of the OSD menu

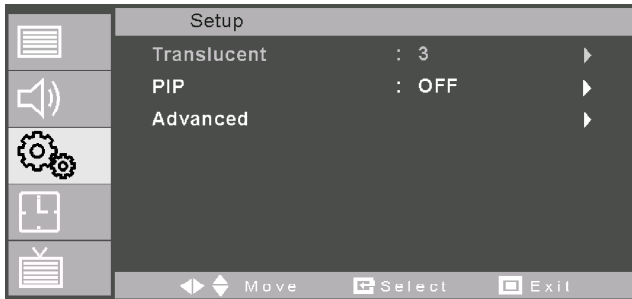
After switching on the device, set the language of the OSD (On Screen Display) menu according to your needs. English is the set as the default setting. If you want to use a different language, change this setting with the OSD menu.

- ▶ Switch the plasma TV on with the ON/OFF switch.
- ▶ Press the POWER button.
- ▶ Press the MENU button to open the OSD menu.
- ▶ Choose the *Setup* menu item using the  button.
- ▶ Press the MENU button to activate the menu item.



- ▶ Choose the *Advanced* menu item using the  button.
- ▶ Press the MENU button to activate the menu item.
- ▶ Choose the *Language* menu item using the  button.
- ▶ Press the MENU button to activate the menu item.
- ▶ Select the language to be shown in the OSD menu with the buttons  / .
- ▶ Press the Menu button. The OSD menu will be changed over to the selected language.

Carrying out programme search

A programme search must be carried out to put the plasma TV into operation. Use the supplied remote control.

- ▶ Switch the plasma TV on with the ON/OFF switch.
- ▶ Press the POWER button.

First the signal source must be set to the TV mode.

- ▶ Press the SOURCE button.
- ▶ Choose the *TV* option using the  button.
- ▶ Press the MENU button to activate the menu item.

Then you automatically start the programme search.

- ▶ Press the MENU button to open the OSD menu.
- ▶ Choose the *TV* menu item using the  button.

- ▶ Press the MENU button to activate the menu item.

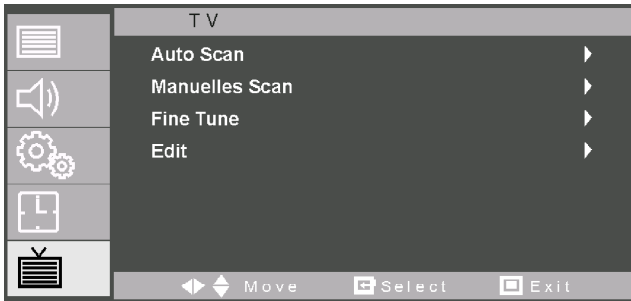

- ▶ Select the *Auto Scan* menu item using the button.
- ▶ Press the MENU button to activate the menu item.
- ▶ Select your country with the button.
- ▶ Press the MENU button to start the programme search.

Wait until the programme search is completed. Then the device shows the first programme found.



The programmes will be entered in the programme list in the order in which they are found. However, you can change the order of the programmes later (see "Arranging programmes").

Adjusting programme settings

After the programme search, you can change various programme settings later, e.g. the order of the programmes in the programme list, the programme names or the frequency of a channel. The following sections contain a description of how to change the settings.

- ▶ Press the MENU button to open the OSD menu.
- ▶ Choose the *TV* menu item using the button.
- ▶ Press the MENU button to activate the menu item.
- ▶ Choose the *Edit* menu item using the button.
- ▶ Press the MENU button to activate the menu item.

The screenshot shows the 'TV >> Edit' menu. It displays a table of 8 programmes. The columns are: PR, Name, CH, Picture, Sound, Skip, and FAV. The first programme (PR 1) has a name that is mostly obscured by a grey bar.

PR	Name	CH	Picture	Sound	Skip	FAV
[1]	-----	C00	AUTO	AUTO	No	No
2	-----	C00	AUTO	AUTO	No	No
3	-----	C00	AUTO	AUTO	No	No
4	-----	C00	AUTO	AUTO	No	No
5	-----	C00	AUTO	AUTO	No	No
6	-----	C00	AUTO	AUTO	No	No
7	-----	C00	AUTO	AUTO	No	No
8	-----	C00	AUTO	AUTO	No	No





At the bottom, there are navigation buttons: 'Move/Edit' (left and right arrows) and 'Exit' (a square with a right arrow).

The programme list will be displayed with the first 8 programmes found. If a programme name was detected during the programme search, it will be displayed.





Arranging programmes

With the OSD menu you can rearrange the order of the programmes according to your personal preferences.

Moving programme

- ▶ Select the programme you want to move with the buttons  / .
- ▶ Press the INSERT button (yellow) to mark the programme to be moved.
- ▶ Select the position at which you want to insert the programme with the buttons  / .
- ▶ Press the INSERT button (yellow). The programme will be inserted at the selected position.

Swapping position of two programmes

- ▶ Select the programme you want to move with the buttons  / .
- ▶ Press the REPLACE button (blue) to mark the programme to be swapped.
- ▶ Mark the programme with which the programme is to be swapped with the buttons  / .
- ▶ Press the REPLACE button (blue). The selected programmes swap their positions.

Changing programme properties

You can change the following properties of a programme:







- Change the programme name displayed in the programme list
- Set the channel of a programme
- Select or automatically assign a different TV standard
- Select the sound standard
- "Hide" a programme in the programme list
- Select a programme as a favourite



All changes are stored automatically.

Changing programme name







Five characters are available for the programme name.

- ▶ Select the programme for which you want to set the name with the buttons  / .
- ▶ Mark the position for the character you want to change under *Name* with the buttons  / .
- ▶ Select the desired character at this position with the buttons  / .







Repeat this procedure until you have entered the desired programme name.

Setting channel of a programme







This function is used when a programme is transmitted on a new station frequency.

- ▶ Select the programme for which you want to set another channel with the buttons  / .
- ▶ Mark the property *CH* with the buttons  / .
- ▶ Select the desired channel with the  /  buttons.



Selecting TV standard



- ▶ Select the programme for which you want to set the TV standard with the buttons  / .
- ▶ Mark the property *Picture* with the buttons  / .
- ▶ Select the desired TV standard with the buttons  /  or assign the suitable TV standard (Pal, Secam; Auto) automatically.

Selecting sound standard

- ▶ Select the programme for which you want to set the sound standard with the buttons  / .
- ▶ Mark the property *Sound* with the buttons  / .
- ▶ Select the desired sound standard (B/G, D/H, L, I, Auto) with the buttons  / .







Hiding programme in programme list

If you want to hide a programme in the programme list (*SKIP=Yes*), the programme is skipped when you change the programmes with the buttons  / .



- ▶ Select the programme you want to hide in the programme list with the buttons  / .
- ▶ Press the SKIP button (green). The selected programme is hidden in the programme list.

Selecting programme as favourite

In the TV mode it is possible to change directly to programmes marked as favourites by pressing the FAVORITE button.

- ▶ Select the program you want to select as a favourite with the buttons  / .
- ▶ Mark the property *FAV* with the buttons  / .
- ▶ Select the value *Yes* with the buttons  / .

Deleting programme

- ▶ Select the programme you want to delete with the buttons  / .
- ▶ Press the ERASE button (red). The selected programme is deleted from the programme list.

Selecting signal source



Selecting signal source for main display

- ▶ Press the SOURCE button in the upper section of the remote control.
- ▶ Choose the signal source you require using the  button.
- ▶ Press the MENU button to activate your selection.

Selecting signal source for PIP display

- ▶ Press the ON/OFF button to activate the PIP mode.
- ▶ Press the SOURCE button in the lower section of the remote control (in the PIP field).
- ▶ Choose the signal source you require using the  button.
- ▶ Press the MENU button to activate your selection.

Changing programme

- ▶ Press the  button to change to the next programme in the programme list.
- ▶ Press the  button to change to the previous programme in the programme list.

Operation

Controls are provided on the device and the remote control for operating the plasma TV.

Operating elements on the device

The operating controls of the plasma TV are located in the underside of the device. With these buttons you can operate the basic functions of the plasma TV.

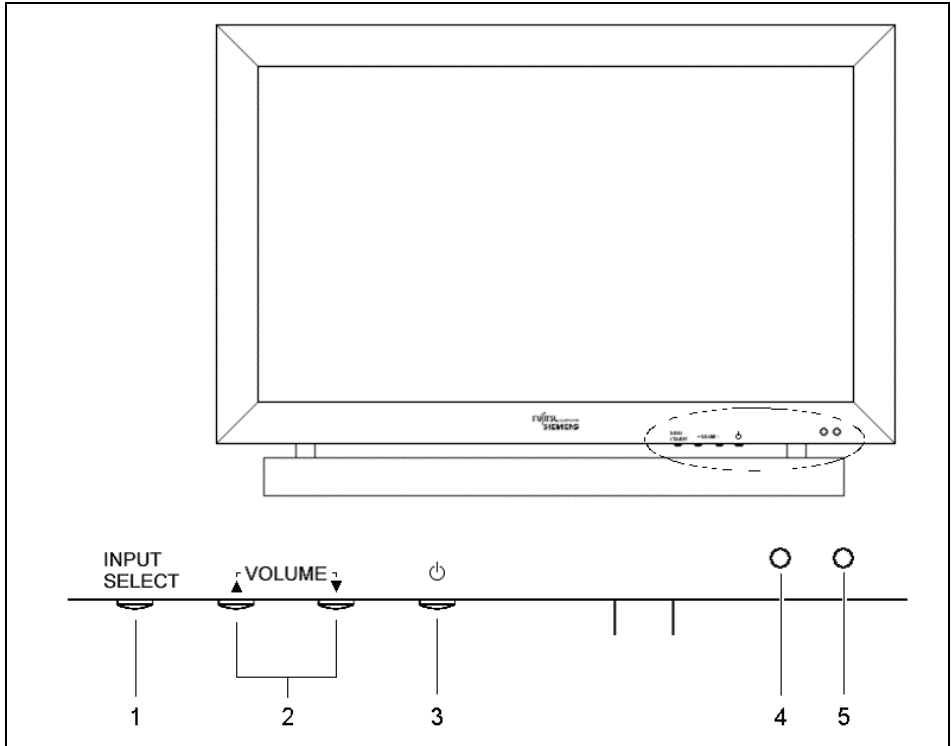

1 = INPUT SELECT button (SOURCE)
for selecting the video input source

2 = VOLUME buttons (volume)

The VOLUME ▲ button opens the menu
for setting the volume.

With the VOLUME ▼ button you can
change the programme in the TV mode.

3 = ON/OFF switch for the standby mode

4 = Indicator

5 = Infrared receiver

Changing the device settings with the buttons of the control panel

With the buttons on the control panel, you can make the following settings directly:

Selecting picture signal source

- ▶ Press the INPUT SELECT button. A list of the signal sources is displayed.
- ▶ Choose the signal source you require using the VOLUME ▲/▼ buttons.
- ▶ Press the INPUT SELECT button to activate the signal source.

Adjusting the volume

- ▶ Press the VOLUME ▲ button to open the volume menu.
- ▶ Set the volume as required with the VOLUME ▲/▼ buttons.

The volume menu automatically disappears again after a short time.

Changing programme

- ▶ Press the VOLUME ▼ button to prepare changing.
- ▶ Change to the next or previous programme in the programme list with the buttons VOLUME ▲/▼.

Remote control

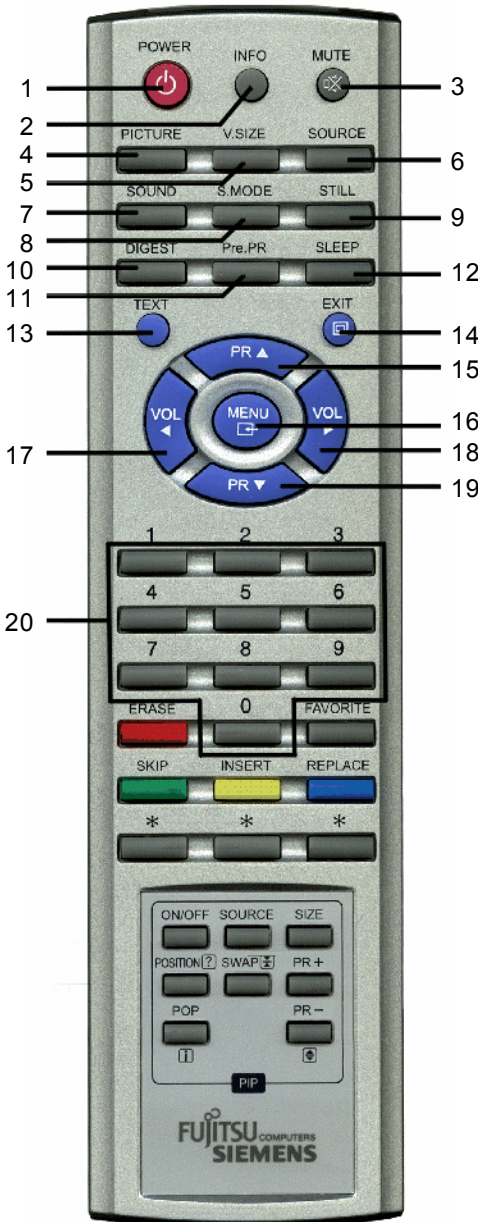

1 = POWER - switches the device on or into the standby mode.

2 = INFO - information
You display the current settings with this button.

3 = MUTE - switches the sound on and off.

4 = PICTURE

With this button you select the picture mode.

5 = V.SIZE

With this button you select the picture format.

6 = SOURCE

With this button you select the signal source.

7 = SOUND

With this function you activate the sound mode.

8 = S.MODE - You select the audio channel with this button.

9 = STILL

With this button you stop the displayed picture (still image) or switch back into the normal playback mode again.

10 = DIGEST - With this button you display the programme overview of all channels.

11 = Pre.PR - Changes back to the programme previously set

12 = SLEEP - Sleep timer

By pressing this button several times, you set the time after which the device is automatically switched off.

13 = TEXT - Switches Teletext on or off

14 = EXIT - Closes the submenu or the OSD menu

15 = PR ▲ - Changes the main display to the next programme in the programme list

16 = MENU - Opens the OSD menu

17 = VOL ◀ - Decrease volume

18 = VOL ▶ - Increase volume

19 = PR ▼ - Changes the main display to the previous programme in the programme list

20 = 0 - 9

With this button you select the programme directly.

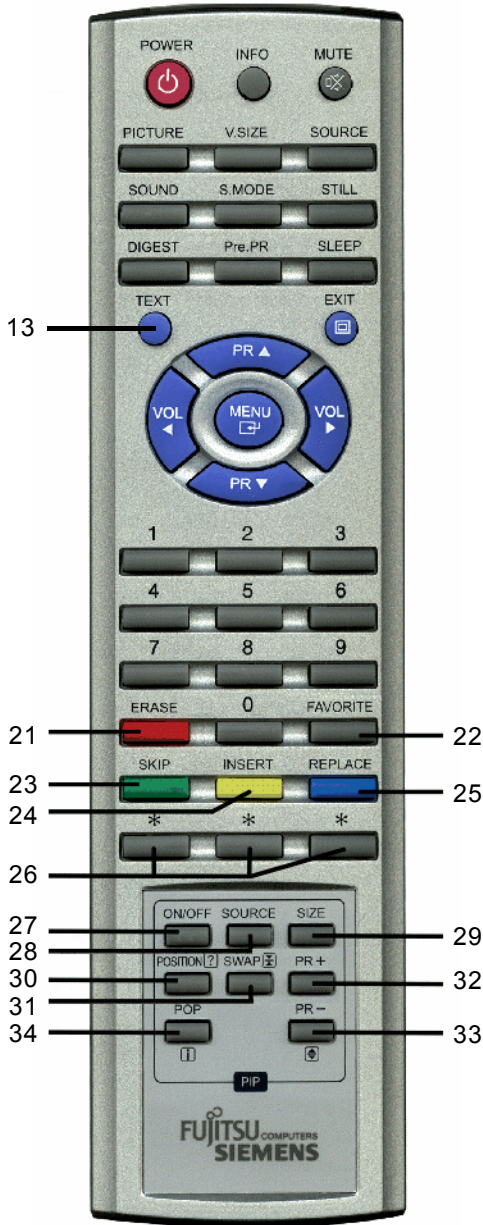

Teletext

With button **13** you switch Teletext on or off. With the buttons **21**, **23**, **24** and **25** you navigate in the Teletext function.

Buttons for editing programme list

The detailed description of editing the programme list is provided under "Adjusting programme settings".

21 = ERASE (red) - Deletes the selected programme from the programme list

23 = SKIP (green) - The marked programme is skipped when changing programmes with the buttons PR ▲ and PR ▼

24 = INSERT (yellow) - Moves programme see "Arranging programmes"

25 = REPLACE (blue) - Exchanges programmes, see "Arranging programmes"

22 = FAVORITE - Switches over to the programme set as a favourite.

26 = No function

PIP (Picture in Picture)

27 = ON/OFF - Activates the PIP mode

28 = SOURCE

Press this button to select the signal source for the PIP mode.

29 = SIZE

Press this button to select the picture format for the PIP mode.

30 = POSITION

Press this button to change the position of the PIP window.

31 = SWAP - The displays of the main and the PIP window are exchanged.



32 = PR+ - Changes to the next programme of the programme list in the PIP window

33 = PR- - Changes to the previous programme of the programme list in the PIP window

34 = POP - Main display and PIP window are shown in the same size next to each other

Changing device settings with remote control

You can open and operate the integrated OSD (On Screen Display) menu with the remote control. To set the OSD menu, perform the following steps:

- ▶ Press the MENU button to open the OSD menu.
- ▶ Mark the desired menu item with the  /  buttons.
- ▶ Press the MENU button to activate a menu item.

In the individual menus, the buttons available to you in each case are shown in the footer.

- ▶ Mark the option you want to change.
- ▶ Set the desired value or activate the desired function.
- ▶ Press the EXIT button to return to the main menu from a submenu or to exit the OSD menu.

All changes are stored automatically.





Description of menus

i



The OSD menu is available in different languages. The English menu names are used in the following description (default setting).

Different menus and different options are available to you depending on the set signal source. The menus and options not available are not shown in the OSD menu.

The following main menus are available to you in the OSD menu:

	<p><i>Picture</i></p> <p>Here you set the picture mode, the colour temperature and the picture format.</p>
	<p><i>Sound</i></p> <p>Here you set the sound of your plasma TV.</p>
	<p><i>Setup</i></p> <p>Here you set the advanced settings (transparency of the OSD menu, picture in picture mode, child lock etc.).</p>
	<p><i>Time</i></p> <p>Here you set the various time functions.</p>
	<p><i>TV</i></p> <p>Here you start the automatic programme search and adjust the programme settings to meet your needs.</p>

PICTURE menu - picture settings

- ▶ Press the MENU button to open the OSD menu.
- ▶ Mark the *Picture* menu item with the  /  buttons.
- ▶ Press the MENU button to activate the menu item.

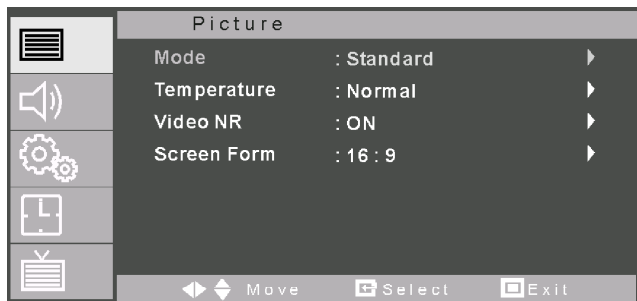

The buttons available to you for setting the options are shown in the menu footer.



<i>Mode</i>	With this function you set the picture mode. The contrast, brightness, colour and focus of the picture are set to optimum values depending on the picture mode. Possible values: <i>Standard, Vivid, Mild, User</i> . After the <i>User</i> option is selected, a further submenu appears:	
	<i>Contrast</i>	This function increases or decreases the contrast.
	<i>Brightness</i>	With this function you set the picture brighter or darker.
	<i>Colour</i>	With this function you set the colour saturation.
	<i>Sharpness</i>	With this function you set the sharpness of the picture.
	<i>Callback</i>	With this function you reset all parameters of this menu to the factory settings.
<i>Temperature</i>	With this button you set the colour temperature. Possible values: <i>Cool2, Cool1, Normal, Warm1, Warm2</i> .	
<i>Video NR</i>	With this function you switch the picture correction (Noise Reduction) on or off. Possible values: <i>On, Off</i>	
<i>Screen form</i>	With this function you set the picture format. Possible values: <i>16:9, PANORAMA, ZOOM1, ZOOM2, 4:3</i> .	

<i>Geometry</i> (in PC mode only)	With these functions you set the position and the synchronisation of the picture display. To set the picture display, first use the <i>Auto</i> function and correct the picture display and, if necessary, then with the other functions. These functions are only available when <i>PC</i> is selected as the signal source.	
	<i>H Position</i>	With this function you set the horizontal picture position.
	<i>V Position</i>	With this function you set the vertical picture position.
	<i>Phase</i>	With this function you fine-tune your display to eliminate picture interference.
	<i>Auto</i>	With this function you optimally set the picture display automatically.

SOUND menu - sound settings

- ▶ Press the MENU button to open the OSD menu.
- ▶ Mark the *SOUND* menu item with the  /  buttons.
- ▶ Press the MENU button to activate the menu item.

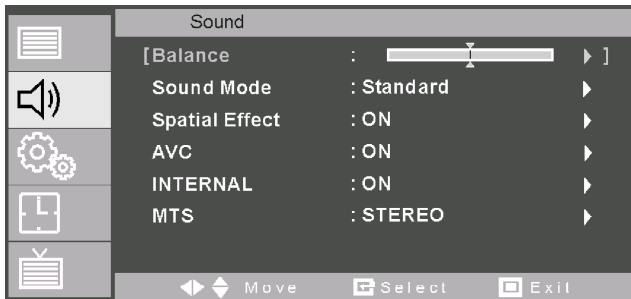

The buttons available to you for setting the options are shown in the menu footer.



<i>Balance</i>	With this function you set the balance between the left and the right loudspeaker.
<i>Sound-Mode</i>	With this function you activate the sound mode. The bass level and frequency of the sound are automatically set to optimum values depending on the sound mode. Possible values: <i>Standard, Movie, Music, User</i> .
<i>Spatial Effect</i>	With this function you switch the Surround sound mode on or off. Possible values: <i>On, Off</i>

<i>AVC</i>	(Automatic Volume Control) With this function you switch the automatic volume control on or off. Possible values: <i>On, Off</i>
<i>Intern</i>	With this function you change from the internal loudspeakers to the external ones and vice versa. Possible values: <i>On, Off</i>
<i>MTS</i>	(Multi Tone System) With this function you set the audio channel. Possible values: <i>Mono, Stereo, Language A, Language B, Language AB.</i>

SETUP menu - advanced settings

- ▶ Press the MENU button to open the OSD menu.
- ▶ Mark the *Setup* menu item with the  /  buttons.
- ▶ Press the MENU button to activate the menu item.

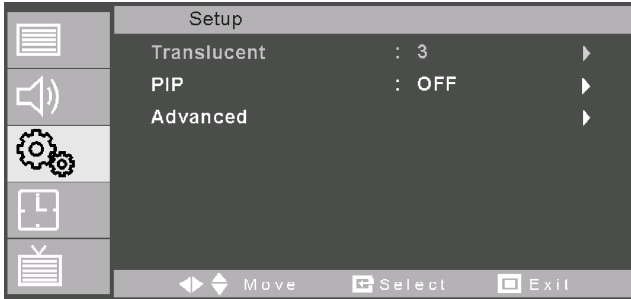

The buttons available to you for setting the options are shown in the menu footer.



<i>Translucent</i>	With this function you set the transparency of the OSD menu Possible values: <i>Off, 1 - 7</i>	
<i>PIP</i>	(Picture In Picture) With this function you switch the PIP mode on or off. Possible values: <i>On, Off</i> When the PIP mode is activated, the following options are available:	
	<i>Size</i>	Here you set the picture format for the PIP display.
	<i>Resource</i>	Here you set which signal source is displayed in the PIP display.
	<i>Picture Swap</i>	With this function you exchange the signal sources of the main display and the PIP display.
	<i>Position</i>	Here you set the position of the PIP display.
A description of the PIP mode is also provided under "PIP mode (Picture in Picture)" and "Selecting signal source for PIP display".		

<i>Advanced</i>	Here you configure the advanced settings.	
	<i>ID</i>	Here you set an ID number for service purposes. Possible values: <i>0 - 99</i>
	<i>Burn Protect</i>	With this function you can partially prevent still images from burning in. Possible values: <i>On, Off</i> Warning: Avoid still images on the screen for longer periods, e.g. still images from videos, sender label etc. (maximum of 1 hour).
	<i>Burn Clear</i>	With this function you can regenerate burned-in areas of the screen in some cases. Possible values: <i>On, Off</i>
	<i>Blue Back</i>	With this function the screen background is shown in blue when there is no input signal. Possible values: <i>On, Off</i>
	<i>Language</i>	With this function you set the language of the OSD menu. Possible values: <i>English, German, French, Spanish, Italian, Portuguese *) , Dutch *)</i> *) not with MYRICA P42-1AH
	<i>Child Lock</i>	With this function you switch the child lock on or off. When the child lock is activated, it is not possible to operate the plasma TV with the operating buttons on the device. Possible values: <i>On, Off</i>

TIME menu - time settings

- ▶ Press the MENU button to open the OSD menu.
- ▶ Mark the *Time* menu item with the  /  buttons.
- ▶ Press the MENU button to activate the menu item.

The buttons available to you for setting the options are shown in the menu footer.

MYRICA P42-1AH

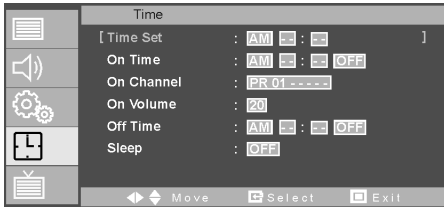



MYRICA P42-2H / P50-2H





<i>Time Set</i>	With this button you set the current time. Format: Hour:Minute With MYRICA P42-1AH: <i>AM</i> (before 12:00 noon); <i>PM</i> (after 12:00 noon)
<i>On Time</i>	With this function you set the time at which the device is to be automatically switched on. Format: Hour:Minute To activate the function, set the selection to <i>On</i> after setting the time. To deactivate the function, set the selection to <i>Off</i> after setting the time.
<i>On Channel</i>	With this function you set the program to be displayed after automatic switch-on.
<i>On Volume</i>	With this function you set the volume to be used after automatic switch-on.
<i>Off Time</i>	With this function you set the time at which the device is to be switched off automatically. Format: Hour:Minute To activate the function, set the selection to <i>On</i> after setting the time. To deactivate the function, set the selection to <i>Off</i> after setting the time.
<i>Sleep</i>	With this function you set the number of minutes after which the device is automatically switched off. Possible values: <i>Off</i> , 10, 20, 30, 60, 90, 120, 180

TV menu - programme settings

- ▶ Press the MENU button to open the OSD menu.
- ▶ Mark the TV menu item with the  /  buttons.
- ▶ Press the MENU button to activate the menu item.

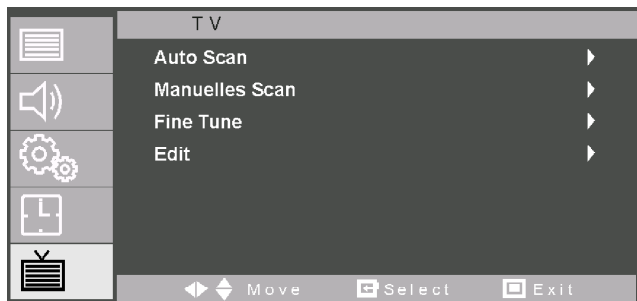
The buttons available to you for setting the options are shown in the menu footer.



<i>Auto Scan</i>	<p>With this function you start the automatic programme search.</p> <p>The automatic programme search must be carried out when you want to use your plasma TV for the first time following installation.</p> <p>The programmes will be entered in the programme list in the order in which they are found. However, you can change the order of the programmes later.</p> <p>A detailed description is provided under "Carrying out programme search" and "Arranging programmes".</p>
<i>Manual Scan</i>	<p>With this function you search for a new programme starting from the frequency of the current channel. When the next programme has been found, you can select whether or not the programme found is to be added to the programme list.</p> <p>To start the search manually, press the  button.</p> <p>To add the programme found to the programme list, press the MENU button. If you want to search for additional programmes, you must restart the manual search.</p> <p>To continue the search, press the  button.</p>
<i>Fine Tune</i>	<p>With this function you manually set the frequency of an individual channel.</p> <p>The set values remain unchanged until an update is carried out.</p>
<i>Edit</i>	<p>With this function you set the order of the programmes in the programme list and the properties of the individual programme.</p> <p>A detailed description is provided under "Adjusting programme settings".</p>

Display modes

Main display mode

- ▶ Press the SOURCE button on the remote control or the INPUT SELECT button on the underside of the plasma TV to select the source from which the signal for the main display is to come.

For the main display you can select one of the following signal sources:

- TV
- SCART1
- SCART2
- S-VIDEO or CVBS (AV)
- Component 1 (YPbPr)
- Component 2 (YPbPr)
- VGA (PC)
- DVI

By pressing the INFO button you display the designation of the currently selected signal sources in the upper left corner of the screen.

PIP mode (Picture in Picture)

The plasma TV can also display a sub-video signal in addition to the main video signal. The sub-video signal is shown as a "PIP display" in a window on the main display.

The following buttons of the remote control are available for setting the PIP mode.

- ▶ Press the ON/OFF button to activate the PIP mode.
- ▶ Press the SOURCE button to select the source from which the signal for the PIP display is to come.
- ▶ Press the SIZE button to set the size of the PIP display.
- ▶ Press the POSITION button to set the position of the PIP display.
- ▶ Press the SWAP button to exchange the size and position of the main display with those of the PIP display.
- ▶ Press the POP button to display the main display and the PIP display in the same size next to each other.
- ▶ If a TV signal is displayed in the PIP display, you change to the next programme in the programme list with the PR+ button, and to the previous programme in the programme list with the PR- button.

Depending on which source the signal for the main display comes from, you can use certain sources for the signal of the PIP display.

The following combination options are available to you:

Signal sources	Main display								
	TV	AV	SV	SCART 1	SCART 2	VGA	DVI	YPbPr	
PIP display	TV	✓	✓	✓	✓	✓	✓	✓	✓
	AV	✓	-	-	✓	✓	✓	✓	✓
	SV	✓	-	-	✓	✓	✓	✓	✓
	SCART 1	✓	✓	✓	-	✓	✓	✓	✓
	SCART 2	✓	✓	✓	✓	-	✓	✓	✓
	VGA	✓	✓	✓	✓	✓	-	-	-
	DVI	✓	✓	✓	✓	✓	-	-	-
	YPbPr	✓	✓	✓	✓	✓	-	-	-

Technical data

	MYRICA P42-1AH	MYRICA P42-2H	MYRICA P50-2H
Screen:			
Size (diagonal)	42" (107 cm)	42" (107 cm)	502" (107 cm)
Visible picture (HxV):	934 mm x 532,2 mm	934 mm x 532,2 mm	1,106,5 mm x 622,1 mm
Number of pixels (HxV):	852 x 480	1024 x 768	1366 x 768
Pixel spacing:	1,095 mm x 1,110 mm	0,912 mm x 0,693 mm	0,810 mm x 0,810 mm
Viewing angle:	Typical > 160°		
Number of colours:	16.7 mio		
Picture format:	16:9		
Horizontal frequency:	31,15 -69 kHz	31,15 - 82 kHz	31,15 - 82 kHz
Refresh rate:	56 -85 Hz	56 -75 Hz (digital) 56 -90 Hz (analogue)	56 -75 Hz (digital) 56 -90 Hz (analogue)
Maximal resolution (PC):	1024 x 768 / 75 Hz (analogue/digital)	1280 x 1024 / 60 Hz (analogue/digital)	1280 x 1024 / 60 Hz (analogue/digital)
Synchronisation:			
Separate:	H / V TTL, P or N		
Composite:	H / V TTL, P or N		
Green synchronisation:	Composite 0.3 Vp-p, negative Video 0.7 Vp-p, positive		
Video signal:	0,7 Vp-p / 75 Ohm		
Colour system:	PAL / SECAM		
Sound system:	BG, DK, I, L		
Video format:	CVBS, S-VHS		
HD TV:			
YpbPr / DVI	480i/p 60 Hz, 576i/p 50 Hz, 720p 50/60 Hz, 1080i 50/60 Hz		
SCART 1:			
Video input/output	1.0 Vp-p @ 75 Ohm		
Audio input/output	0.5 Vms		

	MYRICA P42-1AH	MYRICA P42-2H	MYRICA P50-2H
DVI:	TMDS (DVI-D)		
Power supply (AC):	100 - 240 V (50/60 Hz) 1,8 A / 240 V 4,4 A / 100 V	100 - 240 V (50/60 Hz) 2,0 A / 240 V 4,5 A / 100 V	100 - 240 V (50/60 Hz) 5,0 A / 240 V 2,0 A / 100 V
Power consumption:	Typical: 380 W Standby < 5 W	Typical: 420 W Standby < 5 W	Typical: 500 W Standby < 3 W
Dimensions:			
Width x Depth x Height:	1037 x 94 x 635 mm (without foot) 1037 x 240 x 703 mm (with foot)	1037 x 94 x 635 mm (without foot) 1037 x 240 x 703 mm (with foot)	1208 x 94 x 723 mm (without foot) 1037 x 360 x 775 mm (with foot)
Weight:	approx. 41 kg packed approx. 48 kg	approx. 41 kg packed approx. 48 kg	approx. 54 kg packed approx. 62 kg
Audio:			
Audio input: DVI / PC, Video 1, S-Video, Component1/2, (SCART 1, SCART 2)	RCA connection (L, R) 0.5 Vms		
Audio output:	0.5 Vms at 1 kHz		
Loudspeaker output:	approx. 2 x 8 W (8 Ohm)		
RS-232:	For Service only		
Standard certificate:			
Security:	TÜV-GS ,CE		
EMC:	TV mode: EN55020 class B, EN 55013, EN 61000-3-2/-3 (see CE) PC mode: EN55022 class B, EN 55024, EN 61000-3-2/-3 (see CE)		
Environment:	Condensation must be avoided.		
Temperature:	Operating: +15 ° to +35 ° C Storage: -15 ° to + 60 ° C Change: 1.5 ° C/minute maximum		
Humidity:	Operation: 20 - 85 % without condensation Storage: 20 - 85 % without condensation		
Pressure:	Operation : 800 - 1,114 hPa (height: 0 - 2000 m) Storage : 600 - 1,114 hPa (height: 0 - 4500 m)		
Accessories:	Manual, remote control, battery Power supply cable: 1.8 m Foot with mounting screws		

VESA-DDC-compatible VGA interface

Your plasma TV is equipped with a VESA-DDC-compatible VGA interface and a DVI-D interface. VESA-DDC (Video Electronics Standard Association, Display Data Channel) is used as the communications interface between the plasma TV and the computer. If your computer is equipped with a VESA-DDC-compatible VGA interface, it can automatically read the data for ensuring optimum operation from your plasma TV and select the appropriate settings.

Preset operating modes (PC)

The following are the most frequently used of the preset operating modes:

Resolution	Refresh rate
640 x 350	70 Hz
640 x 480	60 Hz, 72 Hz, 75 Hz
800 x 600	56 Hz, 60 Hz, 72 Hz
1024 x 768	60 Hz, 70 Hz, 75 Hz
1280 x 720 *)	60 Hz, 75 Hz
1280 x 768 *)	60 Hz, 75 Hz
1280 x 1024 *)	60 Hz

*) not with MYRICA P42-1AH

Power consumption

To save energy when the device is temporarily not in use, the plasma TV can be switched into the standby mode with the remote control (POWER button) or the STANDBY button.

	Switched on	Standby mode
Power indicator	lights green	lights red
Function	Device operates normally	the screen is dark
Power consumption	normal < 400 W (P42-1AH) normal < 450 W (P42-2H) normal < 500 W (P50-2H)	reduced to < 5 W reduced to < 3 W reduced to < 3 W



If the device is switched into the standby mode, a power consumption of up to 5 W is maintained to enable operation with the remote control.

To completely switch off the power consumption, switch off the device with the ON/OFF switch (see "Switching plasma TV on/off").

PC Analogue (D-SUB)

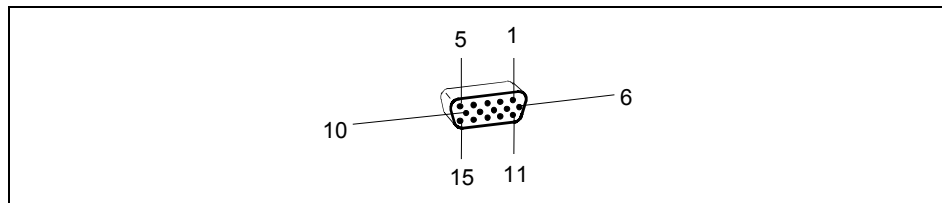

Pin	Meaning
1	Video input red
2	Video input green
3	Video input blue
4	Earth
5	Earth
6	Red video earth
7	Green video earth
8	Blue video earth

Pin	Meaning
9	+5 V (DDC)
10	Sync. earth
11	Earth
12	DDC-Data
13	H. sync
14	V. sync
15	DDC Clock

PC Digital (DVI-D)

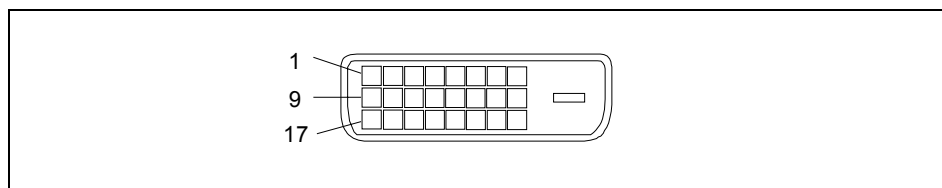

Pin	Meaning
1	TMDS Data2-
2	TMDS Data2+
3	TMDS Data 2/4 Shield
4	not connected
5	not connected
6	DDC Clock
7	DDC Data
8	Analogue Vertical Sync

Pin	Meaning
9	TMDS Data1-
10	TMDS Data1+
11	TMDS Data 1/3 Shield
12	not connected
13	not connected
14	+5V Power
15	Earth
16	Hot Plug Detect

Pin	Meaning
17	TMDS Data0-
18	TMDS Data0+
19	TMDS Data 0/5 Shield
20	not connected
21	not connected
22	TMDS Clock Shield
23	TMDS Clock-
24	TMDS Clock+

SCART (Half/Full)

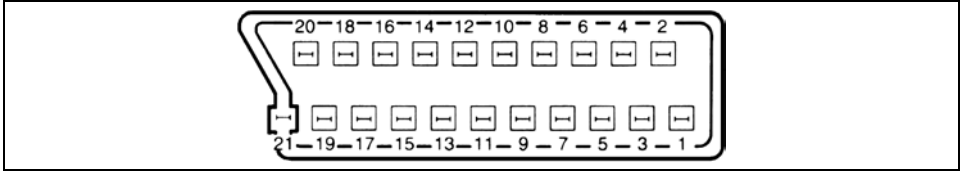

Pin	Meaning
1	Sound (R) output
2	Sound (R) input
3	Sound (L) output
4	Sound signal earth
5	Blue earth *)
6	Sound (L) input
7	Blue *)

Pin	Meaning
8	Changeover voltage
9	Green earth *)
10	Not assigned
11	Green *)
12	Not assigned
13	Red earth *)
12	Blanking earth

Pin	Meaning
15	Red *)
16	Blanking *)
17	Video output earth
18	Video input earth
19	Video output **)
20	Video input
21	Shield earth

*) Not used with SCART (Half)

**) TV-Out for SCART (Half); current picture signal for SCART (Full)

S-Video

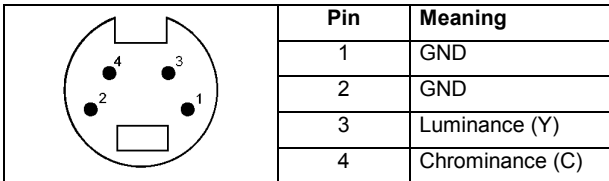

Colour and transmission system by country

Country	TV	Colour	Stereo	Subtitles
Albania	B/G	PAL		
Austria	B/G	PAL	FM-FM	Teletext
Azores	B	PAL		
Bahrain	B	PAL		
Belgium	B/G	PAL	Nicam	Teletext
Bulgaria	D	SECAM		
Canary Islands	B	PAL		
Croatia	B/H	PAL		
Cyprus	B	PAL		
Czech Republic	D/K	SECAM / PAL		
Denmark	B	PAL	Nicam	Teletext
Egypt	B	SECAM		
Faroe Islands (DK)	B	PAL		
Finland	B/G	PAL	Nicam	Teletext
France	E/L	SECAM		Teletext
Germany	B/G	PAL	FM-FM	Teletext
Gibraltar	B	PAL		
Greece	B/G	PAL		
Hungary	B/G & D/K	PAL	Nicam (Budapest only)	
Iceland	B	PAL		
Iran	H	SECAM		
Ireland	I	PAL	Nicam	Teletext
Israel	B/G	PAL	Nicam	Teletext
Italy	B/G	PAL	FM-FM	Teletext
Jordan	B	PAL		
Kenia	B	PAL		
Luxemburg	B/G	PAL	Nicam	Teletext
Madeira	B	PAL		
Malta	B/G	PAL		
Marocco	B	SECAM		
Monaco	L/G	SECAM / PAL		

Country	TV	Colour	Stereo	Subtitles
Netherlands	B/G	PAL	FM-FM	Teletext
Norway	B/G	PAL	Nicam	
Poland	D/K	PAL		Teletext
Portugal	B/G	PAL		Teletext
Rumania	G	PAL		
Russia	D/K	SECAM		
Saudi Arabia	B	SECAM		
Slovakia	D/K	SECAM / PAL		
Slovenia	B/H	PAL		
South Africa	I	PAL		
Spain	B/G	PAL	Nicam	Teletext
Sweden	B/G	PAL	Nicam	Teletext
Switzerland	B/G	PAL	FM-FM	Teletext
Tunesia	B	SECAM		
Turkey	B	PAL		Teletext
United Arab Emirates	B/G	PAL		
United Kingdom	I	PAL	Nicam	Teletext

Troubleshooting

Should an error occur, first check the following points. If the distortion is still not eliminated, the plasma TV should, if possible, be checked on another signal source and/or with another data cable.

If you are unable to solve the problem, please inform our help desk.

Having this problem?	Check the following points:
No display (power indicator does not light)	<ul style="list-style-type: none"> ▶ Check whether the power cable of the device is properly plugged in and the ON/OFF switch on the back of the device is switched on.
Display becomes darker	<p>The phosphorous illumination has a limited lifetime. If your screen display should become too dark, it will have to be exchanged.</p> <ul style="list-style-type: none"> ▶ Please contact our help desk.
Permanently unlit or lit pixels	<p>The standard of production techniques today cannot guarantee an absolutely fault-free screen display. A few isolated constant lit or unlit pixels may be present. The maximum permissible number of this kind of defective pixels is dependent on the resolution:</p> <p>6L / 10D / 10T</p> <p>L = light, D = dark, T = total</p>
No picture (power indicator glows orange)	<ul style="list-style-type: none"> ▶ Switch on the plasma TV on the device or with the remote control. ▶ Check the setting of the picture signal source.
The remote control does not work.	<ul style="list-style-type: none"> ▶ Check whether the batteries in the remote control are still sufficiently charged. ▶ Make sure that the sensor for the remote control on the plasma TV is not exposed to strong light.

Troubleshooting in TV mode

Having this problem?	Check the following points:
No sound	<ul style="list-style-type: none"> ▶ Check the volume setting. ▶ Check whether the device is muted.
No picture, only static	<ul style="list-style-type: none"> ▶ Check that the antenna cable is correctly connected. <p>Reception may be poor.</p>
The picture is fuzzy.	<ul style="list-style-type: none"> ▶ Check that the antenna cable is correctly connected. <p>Reception may be poor.</p>
The picture has dark interference lines and a strong humming sound can be heard.	<p>There may be an interference signal on the antenna cable.</p> <ul style="list-style-type: none"> ▶ Have the installation checked. <p>A sheath current filter from the accessories trade can provide a remedy.</p>
The picture has shadows or ghost images	<ul style="list-style-type: none"> ▶ Check the antenna cable. <p>Use a directional antenna instead of an omnidirectional antenna.</p>
The picture shows interference, false colours or line and picture shaking.	<ul style="list-style-type: none"> ▶ Check whether the plasma TV is set to the correct TV system (PAL or SECAM).

Troubleshooting in PC mode

Having this problem?	Check the following points:
Message: No Signal / Keine Eingabe	<ul style="list-style-type: none"> ▶ Check the setting of the picture signal source. ▶ Check whether the antenna or data cable is correctly connected.
Message: Out of range	<p>The input signal (horizontal frequency and refresh rate) at the displayed input does not correspond to the technical plasma TV data.</p> <ul style="list-style-type: none"> ▶ Adjust the video frequency range using the computer software (see documentation for your computer or your graphics card).
Picture position is not correct	<p>The plasma TV recognises an undefined mode (see "Preset operating modes (PC)").</p> <ul style="list-style-type: none"> ▶ Use the OSD function <i>Geometry!Auto</i> to carry out the self-adjustment of the plasma TV. ▶ Set the picture position with the OSD menu. <p>These functions are only available when <i>PC</i> is selected as the signal source.</p>
Picture is shaking	<ul style="list-style-type: none"> ▶ Check whether the data cable for the plasma TV is correctly attached to the monitor port on the computer.