

70" Full HD Digital LED TV

JBL® sound is found everywhere - from top recording studios and concert venues to millions of homes and cars. The worldwide authority in audio reproduction for more than 60 years, JBL engineers have acoustically tuned the audio system for Element's display, creating maximum performance from minimal space. The built-in JBL subwoofer and front speaker system unlocks the powerful studio sound for an unprecedented widescreen cinematic experience.



Instruction Manual

Read all of the instructions before using this TV and keep the manual in a safe place for future reference.

Important Safety Instructions

- Read these instructions – All the safety and operating instructions should be read before this product is operated.
- Keep these instructions – The safety and operating instructions should be retained for future reference.
- Heed all warnings – All warnings on the appliance and in the operating instructions should be adhered to.
- Follow all instructions – All operating and use instructions should be followed.
- Do not use this apparatus near water – The appliance should not be used near water or moisture –for example, in a wet basement or near a swimming pool, and the like.
- Clean only with dry cloth.
- Do not block any ventilation openings. Install in accordance with the manufacture’s instructions.
- Do not install near any heat sources such as radiators, heat registers, stoves, or other apparatus (including amplifiers) that produce heat.
- Do not defeat the safety purpose of the polarized or grounding plug. A polarized plug has two blades with one wider than the other. A grounding plug has two blades and a third grounding prong. The wide blade or the third prong is provided for your safety. If the provided plug does not fit into your outlet, consult an electrician for replacement of the obsolete outlet.
- Protect the power cord from being walked on or pinched particularly at the plugs, convenience receptacles, and at the point where they exit from the apparatus.
- Only use attachments/accessories specified by the manufacturer.
- Use only with the cart, stand, tripod, bracket, or table specified by the manufacturer, or sold with the apparatus. When a cart or rack is used, use caution when moving the cart/apparatus combination to avoid injury from tip-over.
- Unplug the apparatus during lightning storms or when unused for long periods of time.
- Refer all servicing to qualified personnel. Servicing is required when the apparatus has been damaged in any way, such as power supply cord or plug is damaged, liquid has been spilled or objects have fallen into the apparatus has been exposed to rain or moisture, does not operate normally, or has been dropped.
- Please keep the unit in a well-ventilated environment.
- **WARNING:** To reduce the risk of fire or electric shock, do not expose this apparatus to rain or moisture. The apparatus shall not be exposed to dripping or splashing and that objects filled with liquids, such as vases, shall not be placed on apparatus.
- **WARNING:** The wall socket plug is used as disconnect device, the disconnect device shall remain readily operable.
- **WARNING:** The batteries shall not be exposed to excessive heat such as sunshine, fire or the like.
-



- This lightning flash with arrowhead symbol within an equilateral triangle is intended to alert the user to the presence of non-insulated “dangerous voltage” within the product’s enclosure that may be of sufficient magnitude to constitute a risk of electric shock.
- **Warning:** To reduce the risk of electric shock, do not remove cover (or back) as there are no user -serviceable parts inside. Refer servicing to qualified personnel.
- The exclamation point within an equilateral triangle is intended to alert the user to the presence of important operating and maintenance instructions in the literature accompanying the appliance.
-  This equipment is a Class II or double insulated electrical appliance. It has been designed in such a way that it does not require a safety connection to electrical earth.

Contents

Caution.....	3
Safety Information.....	4
What's Included.....	5
Getting Started.....	6-7
Front / Rear View.....	6-7
Wall Mounting.....	7
Connecting to External Devices.....	8
Remote Control Key Functions.....	9-10
Operating Your Television.....	11-19
Select Your Onscreen Language Preference.....	11
Navigating the Onscreen Display.....	12
Choosing a TV Channel.....	12
Selecting Input Source.....	13
Picture Menu Options.....	13
Audio Menu Options.....	14
Time Menu Options.....	14
Setup Menu Options.....	15
Lock Menu Options.....	16-17
Channel Menu Options.....	18-19
USB Multimedia Operation.....	20
Troubleshooting.....	21-23
FCC.....	24
Specifications.....	24

Caution



The exclamation point within an equilateral triangle is intended to alert the user to the presence of important operating and maintenance (servicing) instructions in the literature accompanying the appliance.



The lightning flash with arrowhead symbol, within an equilateral triangle is intended to alert the user to the presence of uninsulated “dangerous voltage” within the products enclosure that may be of sufficient magnitude to constitute a risk of electric shock to the persons.

Safety Information

To ensure reliable and safe operation of this equipment, please read carefully all the instructions in this user guide, especially the safety information below.

Electrical safety

- The TV set should only be connected to a main power supply with voltage that matches the label at the rear of the product.
- To prevent overload, do not share the same power supply socket with too many other electronic components.
- Do not place any connecting wires where they may be stepped on or tripped over.
- Do not place heavy items on them, which may damage the leads.
- Hold the main plug, not the wires, when removing from a socket.
- During a thunderstorm or when not in using the television for long periods, turn off the power switch on the back of the television.
- Do not allow water or moisture to enter the TV or power adapter. Do NOT use in wet, moist areas, such as bathrooms, steamy kitchens or near swimming pools.
- Pull the plug out immediately, and seek professional help if the main plug or cable is damaged, liquid is spilt onto the set, if accidentally exposed to water or moisture, if anything accidentally penetrates the ventilation slots or if the set does not work normally.
- Do not remove the safety covers. There are no user serviceable parts inside. Trying to service the unit yourself is dangerous and may invalidate the product's warranty. Qualified personnel must only service this apparatus.
- To avoid battery leakage, remove exhausted batteries from the remote control, or when not using for a long period.
- Do not break open or throw exhausted batteries on a fire.

Physical safety

- Do not block ventilation slots in the back cover. You may place the TV in a cabinet, but ensure at least 5cm (2") clearance all around.
- Do not tap or shake the TV screen, or you may damage the internal circuits. Take good care of the remote control.
- To clean the TV use a soft dry cloth. Do not use solvents or petroleum based fluids.
- Do not install near any heat sources such as radiators, heat registers, stoves or other apparatus (including amplifiers) that produce heat.
- Do not defeat the safety purpose of the polarized or grounding-type plug. A polarized plug has two blades with one wider than the other. A grounding type plug has two blades and a third grounding prong, the wide blade, or the third prong is provided for your safety. If the provided plug does not fit into your outlet, consult an electrician for replacement of the obsolete outlet.
- Protect the power cord from being walked on or pinched particularly at plugs.
- Unplug the apparatus during lightning storms or when unused for long periods.
- Refer all servicing to a qualified service personnel. Servicing is required when the apparatus has been damaged in any way, such as power-supply cord or plug is damaged, liquid has been spilled, or objects have fallen into the apparatus, has been exposed to rain or moisture, does not operate normally, or has been dropped.
- Please always connect your television to a power outlet with protective ground connection.

What's Included

Unit and Accessories

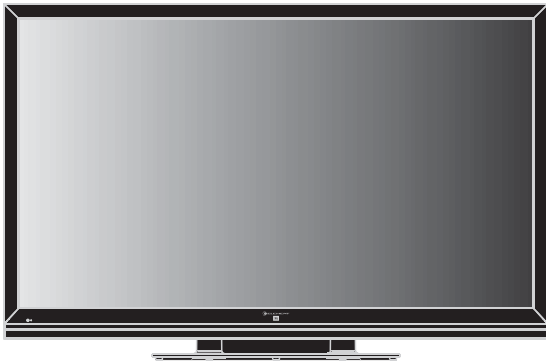

TV Set

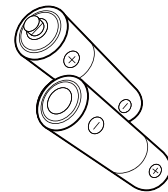

Remote Control with Batteries



User's Manual

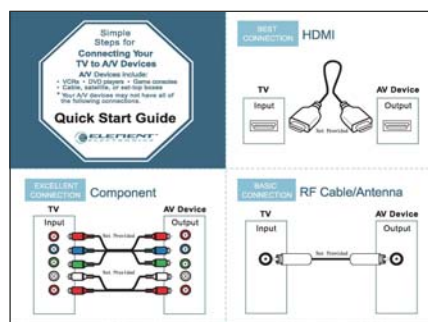

Quick Start Guide



Warranty Card

Getting Started

Front View

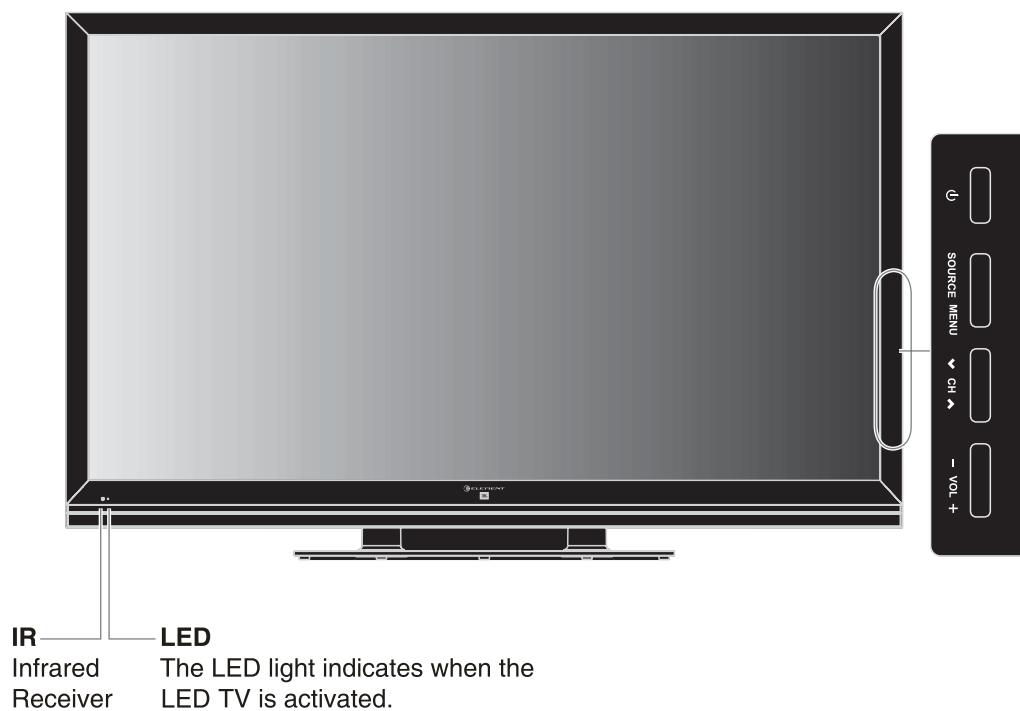

The function of the buttons are described below:

⏻ (POWER) : Turn on/standby the TV set.

SOURCE: Press to display the input source menu.

MENU: Press to display the OSD menu, press again to exit the menu.

CH ^/∨: Press to scan through channels.

VOL +/-: Press to adjust the volume.

Getting Started

Rear View

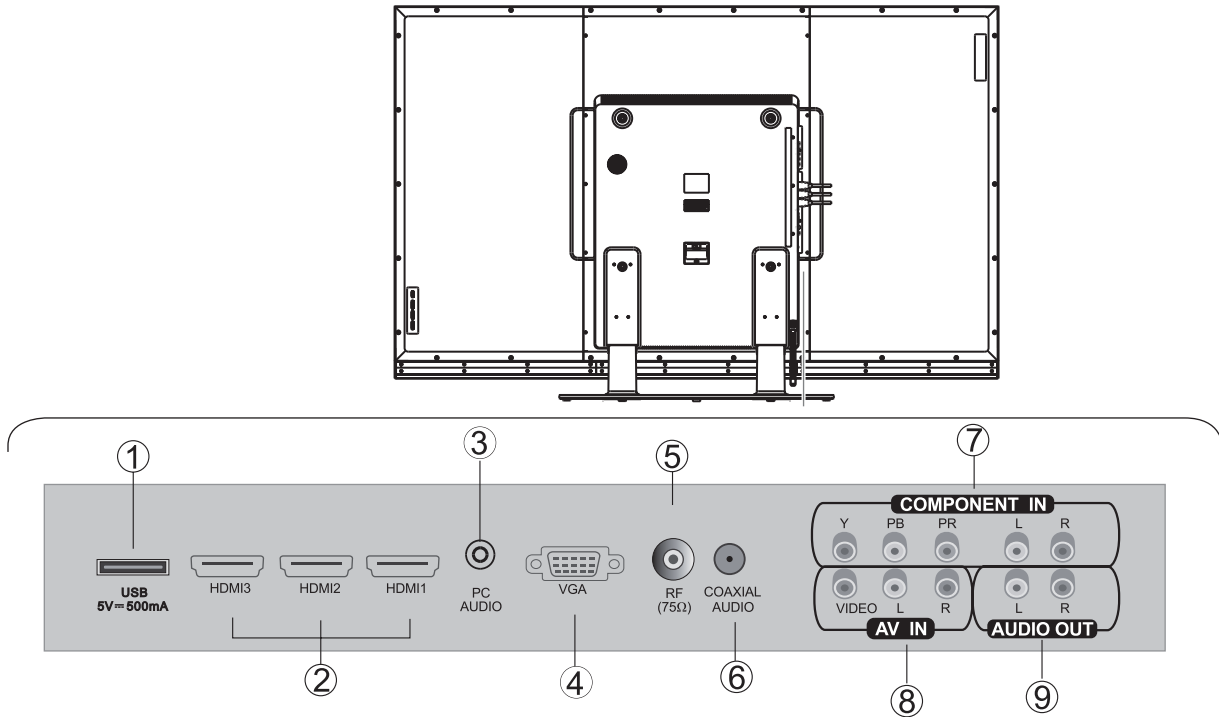

1. USB port.
2. HDMI 1/HDMI2/HDMI3 input.
3. PC audio input.
4. VGA input.
5. Antenna input (75 Ohm VHF/UHF).
6. Coaxial audio signal out socket.
7. Component input terminal.
8. AV input.
9. Audio output.

Wall Mounting

The TV is provided with mounting holes for a VESA approved wall mounting bracket (NOT SUPPLIED). Remove the screws holding the base to the base bracket and lift the base away (do not remove the base mounting brackets). Mount the VESA bracket using 4 x M8x30 isometric threaded screws (not supplied). Do not use screws longer than 30mm; damage will occur to the internal parts.

Caution: Your new TV is heavy, please consult with a professional wallmount installer to perform this installation.

Connecting to External Devices

Connecting external devices to your LED TV

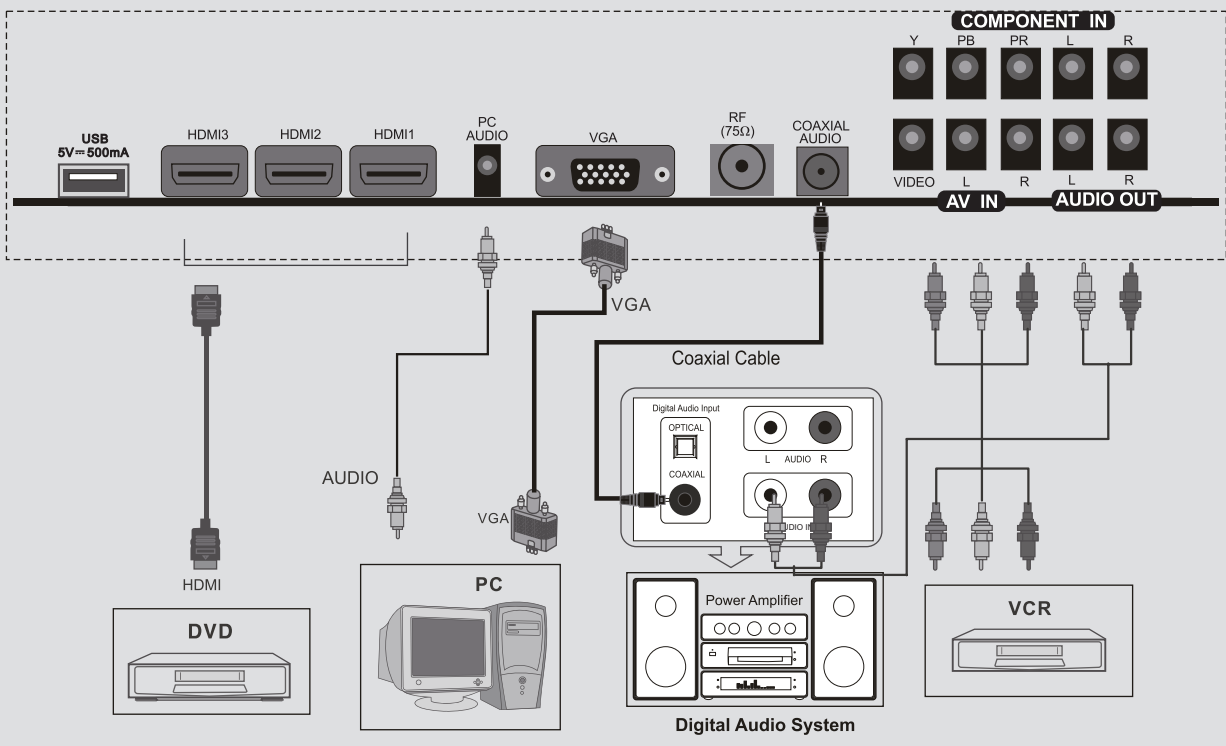
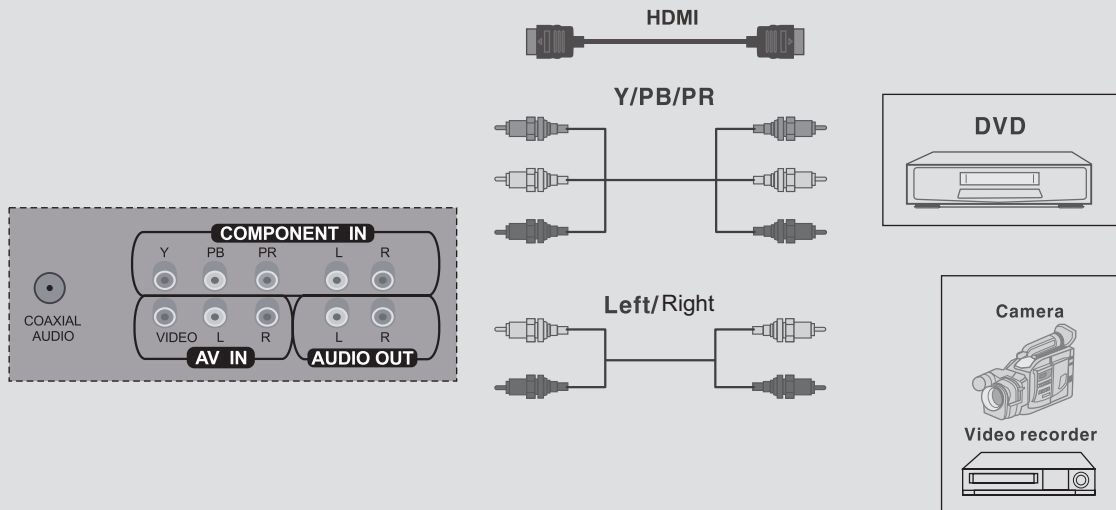

Remote Control Key Functions

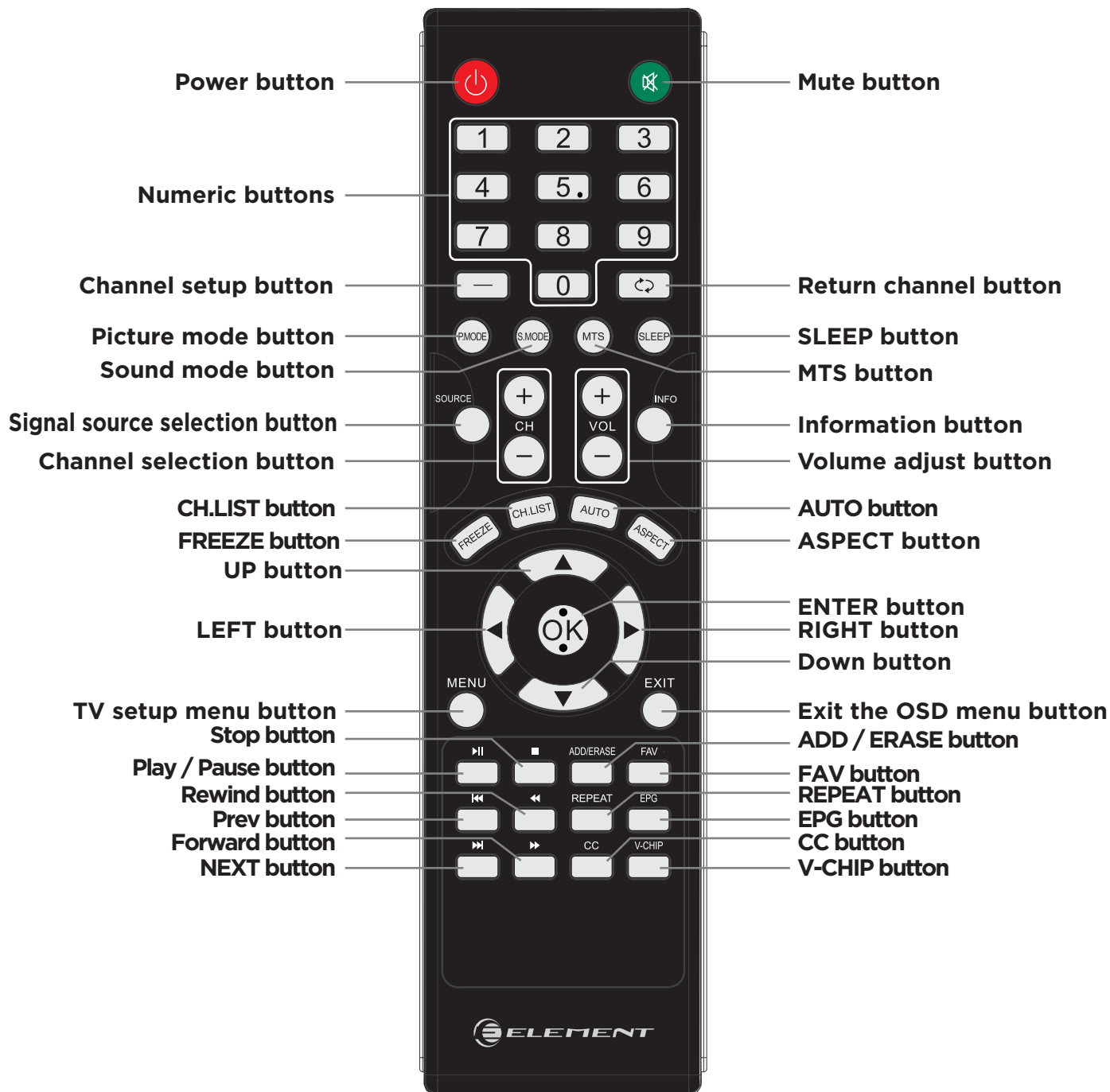

If there is light around the TV, the remote control may fail or work abnormally.
 If not using the remote for a long period of time, please remove the batteries.
 Remote control function keys to practice prevail.

Remote Control Key Functions

POWER: Power on/off button,press once to turn the TV on and press again to turn the TV off.

MUTE: Mute button, press once to disable the audio and press again to enable the audio.

0~9: TV channel selection button.

— : Press this button to enter a program number for multiple program channel such as 2-1, etc.

↶↷ : Previous channel button, return to the previous channel watched.

P.MODE: Setting the picture mode.

S.MODE: Setting the sound mode.

MTS: Press to select the audio channels.

- Make sure the TV has searched the channel and that there is a Analog Stereo / Dual Sound Signal shown on the program.
- Then press the MTS (Multichannel Television Sound) button to select STEREO, MONO and SAP.

SLEEP: Sleep button,setting TV power off time.

SOURCE:Signal source selection button (TV/AV/Component/HDMI1/HDMI2/HDMI3/VGA/USB)

INFO: Press info button to view the current channel. Press again to remove channel information.

CH+/-: Channel selection button, to increase or decrease channel.

VOL+/-: Volume adjusting button, to increase or decrease the volume.

FREEZE: Freeze picture for TV.

CH.LIST: Display program list.

AUTO: Auto adjust(only use in the VGA source).

ASPECT: Select display mode: Wide/Zoom/Cinema/Normal.

▲/▼(Up/Down): Up and down button of OSD menu. To change the OSD menu items.

◀/▶(Left/Right): Left and right button of the OSD menu. To select the OSD menu items .

OK: To confirm the choice with the highlighted menu item.

MENU: OSD menu button,to enter the TV setup menu.

EXIT: Press the EXIT to exit operation.

ADD/ERASE: Add or deleted Favorite channel.

FAV: Display favorite of program list.

EPG: Electronic Program Guide function.

CC: Closed Caption select button ON, OFF or CC ON Mute.

V-CHIP: Setting up parental control.

USB Operation

▶||: Press ▶|| once to pause,Press ▶|| again to return to normal play.

■: Press ■ to stop playback and clear the memory. Press ▶|| button to resume play.

◀◀: Press ◀◀ to play the prev chapter.

◀◀: Press ◀◀ button for quick rewind search.

▶▶: Press ▶▶ to play the next chapter.

▶▶: Press the ▶▶button for quick forward search.

REPEAT: Press REPEAT button to select the repeat mode when play music in USB source.

Operating Your Television

Basic Operations

Turning Your TV On and Off

TURN ON LED TV

1. Connect to power with the main power cable, at this time the TV will enter STANDBY mode and the LED will be red.
2. From the STANDBY mode, use the POWER button either on the main unit or on the remote to turn your television on.

TURN OFF LED TV

From ON mode, use the POWER button either on the main unit or on the remote to turn your television to STANDBY mode.

Select Your Onscreen Language Preference

Note: If using your LED TV for the first time, you should select the language which will be used for displaying menus and information boxes.



- Press ▲/▼ button to select Menu Language.
- Press ◀/▶ button to select your desired language.
- When you are satisfied with your choice, press the **MENU** to exit.

Volume Adjustment

1. Press **VOL +/-** to adjust the volume
2. If you want to switch the sound off, press the **MUTE**  , Press again to resume.

Operating Your Television

Navigating the Onscreen Display

- Press the MENU button to display the main menu.
- Use ▲/▼ buttons to navigate and select the available menus.



Choosing a TV Channel

1. Use the CH+/CH- on the front panel or on the remote control.

- Press CH+ to increase the channel.
- Press CH- to decrease the channel.

2. Using 0-9 remote keys.

Enter the channel number with the 0-9 remote keys, then press "OK" to select the channel.

For example:

1. Press 4, then press "OK" to select channel 4.
2. Press 4, then press 5, then press "OK" to select channel 45.
3. Press 1, then press 2, then press 1, finally press "OK" to select channel 121.

Operating Your Television

Selecting Input Source

You can display the input screen menu by pressing **SOURCE** on the remote control or **SOURCE** at the side of the panel, press **▲/▼** button to select, press **“OK”** to confirm.

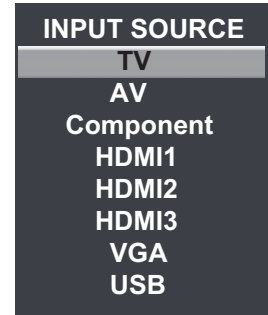

Picture Menu Options

Press the **MENU** at the side of the panel or **MENU** on the remote control and then use **▲/▼** to move the **PICTURE** menu, press **▶** or **OK** to enter (see picture below).

NOTE: Adjust the parameters of the picture, the Picture Mode is automatically converted to User Mode.

Picture Mode

Select the type of picture which best corresponds to your viewing preferences by selecting Picture Mode in the **PICTURE** menu. You may select the picture mode directly by pressing the **P.MODE** button on the remote control.

Contrast

Press **▲/▼** and then use **◀/▶** to adjust the contrast of the picture.

Brightness

Press **▲/▼** and then use **◀/▶** to adjust the brightness of the picture.

Color

Press **▲/▼** and then use **◀/▶** to adjust the color of the picture.

Tint

Press **▲/▼** and then use **◀/▶** to adjust the tint of the picture.

Sharpness

Press **▲/▼** and then use **◀/▶** to adjust the sharpness of the picture.

Color Temp.

Press **◀/▶** to select mode, Cool, Warm, Normal.

Blue Screen

Press **▲/▼** and then use **◀/▶** to select On or Off.

Auto Motion 120Hz

Press **▲/▼** and then use **◀/▶** to select Off, Normal, Strong, Low or Demo.

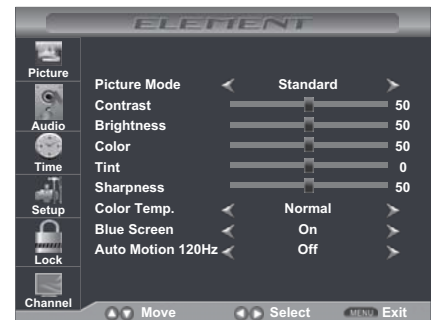

Operating Your Television

Audio Menu Options

Press **MENU** at the side of the panel or **MENU** on the remote control and then use **▲/▼** to move the **AUDIO** menu, press **▶** or **OK** to enter (see picture below).

NOTE: Adjust the parameters of the sound, the Sound Mode is automatically converted to User Mode.

Sound Mode

Press **▲/▼** and then use **◀/▶** to select User, Standard, Music and Movie.

Bass

Press **▲/▼** and then use **◀/▶** increase or decrease the level of the lower-pitched sounds.

Treble

Press **▲/▼** and then use **◀/▶** to increase or decrease the level of higher-pitched sounds.

Balance

Press **▲/▼** and then use **◀/▶** to adjust the audio output between left and right speakers.

Surround Sound

Press **◀/▶** to switch surround sound On or Off.

Auto Volume

Press **◀/▶** to switch auto volume control On or Off. This function allows volume to be controlled automatically.

SPDIF Type

Press **◀/▶** to select between PCM or RAW.

Audio language

Press **◀/▶** to select audio languages among: English, French, Spanish.



Time Menu Options

Press the **MENU** at the side of the panel or **MENU** on the remote control and then use **▲/▼** to move the **TIME** menu, press **▶** or **OK** to enter (see picture below).

Sleep Timer

Press **▲/▼** and then use **◀/▶** to set up the sleep timer among: Off, 5Min, 10Min, 15Min, 30Min, 45Min, 60Min, 90Min, 120Min, 180Min or 240Min.

Time Zone

Press **▲/▼** and then use **◀/▶** to set up the time zone among: Pacific, Alaska, Hawaii, Eastern, Central or Mountain.

Daylight Saving Time

Press **▲/▼** and then use **◀/▶** to set up the daylight saving time On or Off.



Operating Your Television

Setup Menu Options

Press the **MENU** at the side of the panel or **MENU** on the remote control and then use **▲/▼** to move the **SETUP** menu, press **▶** or **OK** to enter (see picture below).

Menu Language

Press **▲/▼** and then use **◀/▶** to select menu language among: English, Français or Español.

Transparency

Press **▲/▼** and then use **◀/▶** to turn on or off the transparency function.

Zoom Mode

Press **▲/▼** and then use **◀/▶** to select the zoom mode among: Wide, Zoom, Cinema or Normal.

Noise Reduction

Press **▲/▼** and then use **◀/▶** to select the noise reduction mode among: Weak, Middle, Strong, Off.

Advanced

Press **▲/▼** and then use **◀/▶** to select the advanced options between H-POS, V-POS, Clock, Phase, Auto (only used in VGA source mode).

H-POS

Press **▲/▼** and then use **◀/▶** to adjust the H-POS of the picture.

V-POS

Press **▲/▼** and then use **◀/▶** to adjust the V-POS of the picture.

Clock

Press **▲/▼** and then use **◀/▶** to adjust the Clock of the picture.

Phase

Press **▲/▼** and then use **◀/▶** to adjust the Phase of the picture.

Auto

Press **▲/▼** and then use **▶** to adjust the picture.

Closed Caption

Press **▲/▼** and then use **◀/▶** to use the down button to highlight the close caption item, then press the **RIGHT** button to enter into the following menu.

CC Mode

Allows you to select the CC Mode among: On, Off or CC on Mute.

Basic Selection

Allows you to select the basic selection among: CC1, CC2, CC3, CC4, Text1, Text2, Text3 and Text4.

Advanced Selection

Press **▲/▼** and then use **◀/▶** to select the advanced selection among: Service1, Service2, Service3, Service4, Service5, or Service6.

OPTION

Press **▲/▼** and then use **▶** to enter into the following menu.

Press **▲/▼** and then use **◀/▶** to select.

DLC

Press **▲/▼** and then use **◀/▶** to dynamic luminance control On or Off.

Restore Default

Select "Restore Default", press **OK**, and it will display "Are you sure?", select "Yes" to select the factory default settings.

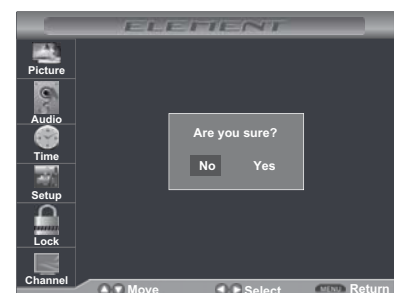
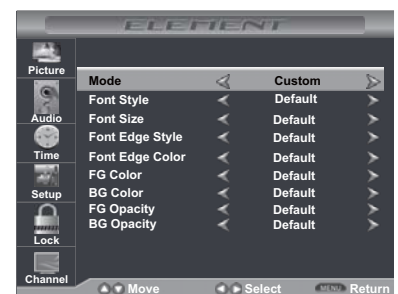
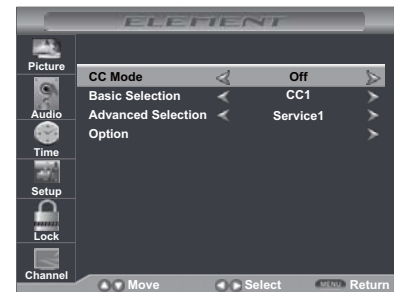
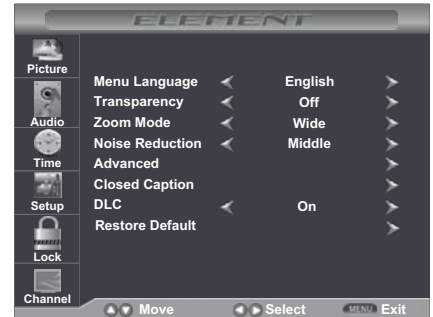

Operating Your Television

Lock Menu Options

Press the **MENU** at the side of the panel or **MENU** on the remote control and then use **▲/▼** to move the **LOCK** menu, press **▶** or **OK** to enter (see picture below).

Use the **DOWN** button to highlight the “Enter Password” item, use the numeric keys to input 4-digital password, then the screen will display the junior menu. After settings, press menu button to exit.

NOTE: The factory password is 0000.

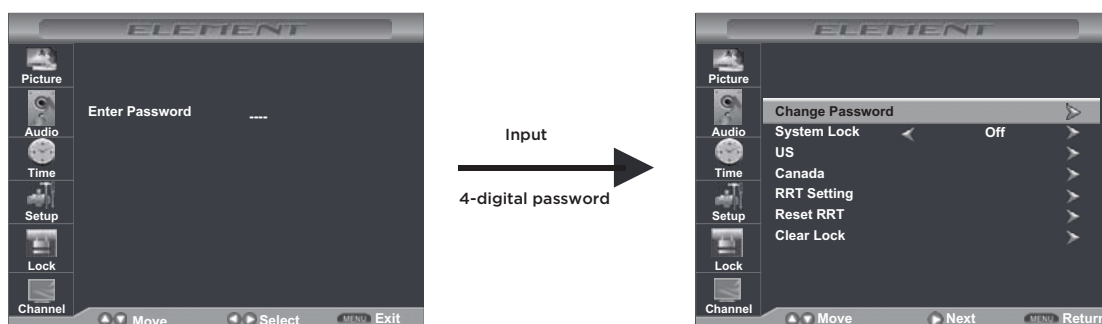

Change Password

Use **DOWN** button to select the “Change Password” item, then press **RIGHT** button to enter into the following menu. Input the new 4-digital password and input it again to confirm.

System Lock

Allows you to turn on or off the system lock. If you turn off the system lock, then the following items (US, Canada, RRT Setting and Reset RRT) will be unable to use.

US

Use **Down** button to highlight the “US” item, then press **RIGHT** button to enter into the following menu.

Canada

Use **Down** button to highlight the “Canada” item, then press **RIGHT** button to enter into the following menu.

Canada English

Use **LEFT** and **RIGHT** buttons to select among: E, C, C8+, G, PG, 14+ and 18+.

Canada French

Use **LEFT** and **RIGHT** buttons to select among: E, G, 8ans+, 13ans+, 16ans+ and 18ans+.

RRT Setting

Rating Region Table setting.

Reset RRT

Allows you to reset the RRT setting.

Clear Lock

Clear lock of RRT.



Operating Your Television

Parental Control

Press Enter to enter the sub-menu and then use the 0-9 to enter the correct password: 0,0,0,0. If used, this option feature can “block” undesirable programming from appearing on the TV. Parental Control offers the user a wide variety of options and settings that restrict or “block” the programming that can appear on the TV. Parental Control allows the user the capability of defining which program rating they consider acceptable, to the younger more sensitive viewer. It can be preset and turned either on or off by the user who specifies the secret 4-number code, the password. The number of hours blocked are specified. General audiences and children blocks should be both programmed into the TV’s memory. Viewer ratings are specified for both TV and the motion picture industry; both rating systems should be used, for complete coverage. The ratings are based on the ages of children.

Overview

To ensure complete coverage for all TV programs, (movies and regular TV shows) choose a rating for MPAA, from the selections below, as well as ratings from the TV Parental Guidelines Rating Systems below, using the Age Block option for General Audiences, and for children. In addition to those, you may wish to add additional restrictions from the content block menu, and submenus examples below.

Things to Consider before Setting up Parental Control

Determine which rating you consider acceptable to the viewer. (For example, if you choose TV-PG, more restrictive ratings will be automatically blocked; the viewer will not be able to see: TV-PG, TV-14, or TV-MA rated programming.) Do you want to block the auxiliary video source entirely? (Blocks the signal sent by the equipment, such as VCR, connected to the TV Audio/Video input jacks) Or leave unblocked, then choose allowable ratings. Block program “Content” based on individual parameters such as: Strong Dialog, Bad Language, Sex Scenes, Violence Scenes, or Fantasy. Violent Scenes; in Content Blk option. Select a secret password, in the Set Password option, using the numbers keys on the remote. Do not forget the password, it is the only way you can access the Parental Control menu and change rating selections, or turn Parental Control off. Do you want the Parental Control to be active at all times? If not, you can turn it on or off with the Lock On/Off option.

- You can set different Parental Control viewing restrictions for general audiences and for children, both can be active at the same time.
- Simply specifying one content block such as Sex Scenes, will not automatically restrict the programming that appears from the video sources.
- Even if you choose to leave the AUX inputs unblocked, the ratings you specify will automatically restrict the programming that appears from the video sources.
- You can not disable Parental Control by disconnecting the TV from power. Block hours will be automatically reset to the original block time setting specified if power is disconnected.

Information

Motion Picture Association of America (MPAA) Rating System

Grade		Meaning
G	General Audiences	Content not offensive to most viewers
PG	Parental Guidance Suggested	Content is such that parents may not want their children to view the program
PG-13	Parental Guidance Strongly Cautioned	Program is inappropriate for preteens, with a greater degree of offensive material suggested than a PG rated program
R	Restricted viewing	Not for children under 17, Strong element of sex and/or violence
NC-17	No Children Under age 17	Not for children under 17 under any circumstances. Strong sexual content
X	Hard Core Films	Same as NC-17 rating
No Rating	No Rating	MPAA Not Rated

TV Parental Guideline Rating System

Grade		Meaning
TV-Y	Young Children	Content not offensive to most viewers
TV-Y7	Children 7 and over	Considered suitable for children over 7, may contain Fantasy Violence Scenes
TV-G	Parental Audience	Considered suitable for all audiences; children may watch unattended
TV-PG	Parental Guidance	Suggested Unsuitable for younger children, may contain; Suggestive Dialogue, Bad Language, Sex, and Violence Scenes
TV-14	Parents Strongly Cautioned	Unsuitable for children under 14, may contain: Strong Dialogue, Bad Language, Sex, and Violence Scenes
TV-MA	Mature Audience Only	Adults only, may contain Strong Dialogue, Bad Language, Sex, and Violent Scenes

Canadian Rating: Canadian English is used throughout all English-speaking Canada (C, C8+, G, PG, 14+, 18+). Canadian French is used in Quebec (G, 8 ans+, 13 ans+, 16 ans+, 18 ans+)

Note: The V-Chip will automatically block certain categories that are “more restrictive”. If you block TV-Y category, then TV-Y7 will be automatically blocked. Similarly, if you block TV-G category, then all the categories in the “young adult” will be blocked (TV-G, TV-PG, TV-14, and TV-MA).

Operating Your Television

Channel Menu Options

Press the **MENU** at the side of the panel or remote control and then use ▲/▼ to move the **CHANNEL** menu. Press ► or OK to enter (see picture below).

Air/Cable

Allows you to select antenna between Air and Cable.

If you select “Air” as input signal in Antenna item, you can press **RIGHT** button to search the channels automatically.

The receivable channels will be stored automatically. When searching channels, press **MENU** to stop.



If you select “Cable” as input signal in Antenna item, allows you to select Cable System among: AUTO, STD, IRC and HRC. Use **DOWN** button to highlight the “Start to Scan”, then press **RIGHT** button to search the channels automatically. The receivable channels will be stored automatically. When searching channels, press **MENU** to stop.

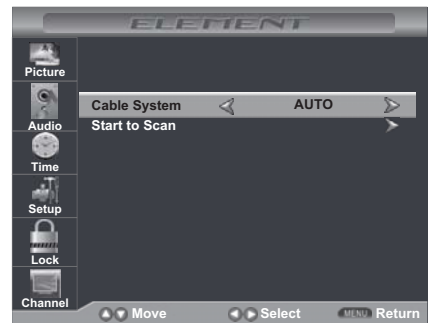

Auto Scan

Use **Down** button to highlight the “Auto Scan” item, then press **RIGHT** button to enter into the following menu.

Favorite

Allows you to add these channels which you desired as the favorite channels.

Use **UP** or **DOWN** button to highlight the “Favorite” item, then press **RIGHT** button to enter into the following menu.

Use **UP** and **DOWN** button to highlight the desired item, then press **OK** button to add or remove the highlighted channel as favorite.



Operating Your Television

Show / Hide

Allows you to show or hide the channels.

Use UP or DOWN button to highlight the “Show / Hide” item, then press RIGHT button to enter into the following menu.

Use UP and DOWN button to highlight the desired item, then press OK button to show or hide the highlighted channel.

Channel No.

Display the number of current channel.

Channel Label

Display the label of current channel.

DTV Signal:

Display the quality of current DTV signal.



USB Multimedia Operation

Multimedia Operation: Music

Press ◀▶ buttons to select the Media Type to Music, press OK button to play the music selected with ▲▼ buttons.

NOTE:file format just supported : MP3
Press ⏸ button once to pause,
Press ▶⏸ button again to return to normal play
Press ■ button to stop playback.
Press ⏮ button to play the previous track.
Press ⏭ button to play the next track
Press ⏪ button for quick rewind search
Press ⏩ button for quick forward search

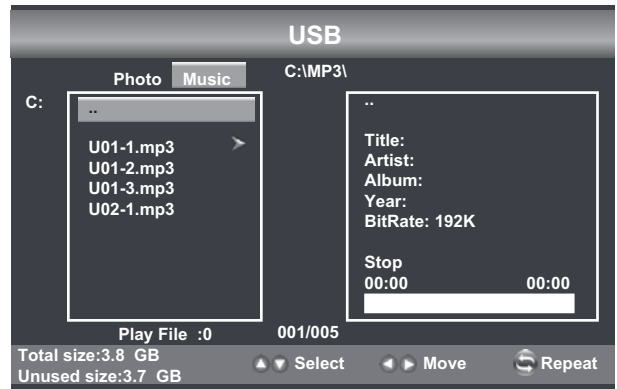

Multimedia Operation: Photo

NOTE:file format just supported : JPEG
First play music ,press ◀ button exit Music mode and into picture mode, select you want view picture, press OK button to play picture, then the Music can playback background of Picture mode.
Press ⏮ button to play the previous track.
Press ⏭ button to play the next track.

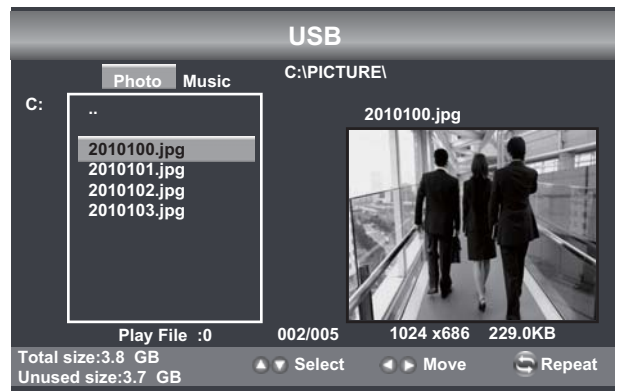

Troubleshooting

If your television does not operate normally or does not turn on, please check the following troubleshooting questions. Remember to also check the other connected electronic devices, such as DVDs or Blu-ray players to pinpoint any problem. If the television still fails to operate normally, please contact technical support (refer to Warranty page).

SYMPTOM	POSSIBLE CAUSE	REMEDY
Dead. No LED lit	No power to the TV.	Check all connections to the TV's AC socket.
Dead. No LED lit red	Set in standby mode.	Press either the Power button or the Standby button on the remote control.
Blue screen	No signal.	Press SOURCE button to select the correct source
	Incorrect source selected.	
Noisy, snowy, ghosting picture (TV)	Poor antenna signal.	If using an indoor antenna, try adjusting the antenna position. Check antenna connections
No sound	Sound "Mute".	Turn sound "Mute" OFF.
	Volume set too low.	Check volume settings.
	External leads not connected "if used".	Check that all external leads are connected properly.

Troubleshooting

Before contacting the service technician, perform the following simple checks. If any problem still persists, unplug the LCD TV and call for assistance.

PROBLEM	POSSIBLE SOLUTION
No sound and picture	<ul style="list-style-type: none"> - Check that the main plug has been connected to a wall outlet - Check that you have pressed the POWER button on the front of the TV set - Check the picture contrast and the brightness setting
Red LED indicator light	Set in standby mode. Press either the POWER button or the Standby button on the remote control
Normal picture but no sound	<ul style="list-style-type: none"> - Check the volume - Sound muted? Press the MUTE button - Try another channel, the problem may be with the broadcast - Are the audio cables installed properly?
The remote control does not work	<ul style="list-style-type: none"> - Check to see if there are any objects between the TV and remote control causing obstruction - Are batteries installed with correct polarity (+ / -) - Correct remote operating mode set: TV, VCR, etc? - Install new batteries
Power suddenly turns off	<ul style="list-style-type: none"> - Is the sleep timer set? - Check the power control settings. Power may be interrupted - No broadcast on the station tuned
Picture appears slowly after switching on	- This is normal, the image is muted during the product start up process. Please contact a service provider if the picture has not appeared after 5 minutes
Poor Color or picture	<ul style="list-style-type: none"> - Adjust the color in Menu option - Keep a sufficient distance between the product and the VCR - Try another channel, the problem may be with the broadcast - Are the VIDEO cables installed properly? - Activate any function to restore the brightness of the picture
Horizontal/vertical bars or picture shaking	- Check for local interference, such as an electrical appliance or power tool
Blue Screen	- Press SOURCE button to select correct source
Poor reception on some channels	<ul style="list-style-type: none"> - Station or cable experiencing problems. Tune to another station - Station signal is weak, reorient antenna to receive better reception - Check for sources of possible interference
Lines or streaks in pictures	- Check the antenna (change the direction of the antenna)
No output from one of the speakers	- Adjust balance in the Menu option

Troubleshooting

NOTE: When there is a problem in VGA mode (only when VGA mode is applied)

PROBLEM	POSSIBLE SOLUTION
The signal is out of range	- Adjust resolution, horizontal frequency, or vertical frequency - Check whether the signal cable is connected or loose - Check the input source
Vertical bar or stripe on background, horizontal noise and incorrect position	Set the auto configure or adjust clock, phase or H/V position
Screen Color is unstable or is a single Color	- Check the signal cable - Re-install the PC video card

Maintenance

Early malfunctions can be prevented. Careful and regular cleaning can extend the amount of time you will have with your new TV. Be sure to turn the power off and unplug the power cord before you begin any cleaning.

Cleaning the screen

1. A great tip to dust off your screen. Wet a soft cloth in a mixture of lukewarm water and a little fabric softener or dish washing detergent. Wring the cloth until it's almost dry, and then use to wipe the screen.
2. Make sure the excess water is off the screen, then let air-dry before you turn on the TV.

Cleaning the Cabinet

To remove dirt or dust, wipe the cabinet with a soft, dry, lint-free cloth. Please be sure not to use a wet cloth.

Extended Absence



If you expect to leave your TV dormant for a long time (such as a vacation), it is a good idea to unplug the power cord to protect against possible damages from lightning or power surges.

The FCC Wants You To Know



This equipment has been tested and found to comply with the limits for a Class B digital device, pursuant to Part 15 of the FCC Rules. These limits are designed to provide reasonable protection against harmful interference in a residential installation.

This equipment generates, uses, and can radiate radio frequency energy and, if not installed or used in accordance with the instructions, may cause harmful interference to radio communications. However, there is no guarantee that interference will not occur in a particular installation.

If this equipment does cause harmful interference to radio or television reception, which can be determined by turning the equipment off and on, the user is encouraged to try to correct the interference by one or more of the following measures: 1) reorient or relocate the receiving antenna; 2) increase the separation between the equipment and the receiver; 3) connect the equipment to an outlet on a circuit different from that to which the receiver is connected; 4) consult the dealer or an experienced radio/TV technician for additional suggestions.

Any changes or modifications not expressly approved by the party responsible for compliance could void the user's authority to operate the equipment. Where shielded interface cables have been provided with the product or specified additional components or accessories elsewhere defined to be used with the installation of the product, they must be used in order to ensure compliance with FCC regulation.

Canadian DOC statement
Standard Television Receiving Apparatus Canada BETS-7
This Class B digital apparatus complies with Canadian ICES-003.

Specifications

Panel Size	70 inches diagonally
Display Type	LED
Panel Technology	TFT
Panel 60 Hz vs 120 Hz	120Hz
Display Resolution	1080P
HD Compatible	up to 1080p
Panel Resolution	1920 x 1080
Aspect Ratio	16:9
Dynamic Contrast Ratio - panel	5,000:1
Brightness (Centre Typ.) cd/m ²	350
Response Time (G to G)	4 ms
Lamp Life (Typ. Hours)	50,000 hours
Horizontal Viewing Angle (At CR>10)	176
Vertical Viewing Angle (At CR>10)	176

JBL, the JBL logo, and harman kardon, are trademarks of Harman international industries, incorporated, registered in the united states and/or other countries.



This product contains electrical or electronic materials. The presence of these materials may, if not disposed of properly, have potential adverse effects on the environment and human health.

Presence of this label on the product means it should not be disposed of as unsorted waste and must be collected separately. As a consumer, you are responsible for ensuring that this product is disposed of properly. To find out how to properly dispose of this product, please go to www.elementelectronics.com and click on Sustainability.

HDMI™

This TV incorporates High-Definition Multimedia Interface (HDMI™) technology. HDMI, the HDMI logo and High-Definition Multimedia Interface are trademarks or registered trademarks of HDMI Licensing LLC.

