



EMERSON AND THE G-CLEF LOGO ARE REGISTERED TRADEMARKS OF EMERSON RADIO CORP., PARSIPPANY, NEW JERSEY, U.S.A.

# 32 inch Digital / Analog LCD TV

## Owner's Manual **LC320EM8**



**TO RECEIVE DIGITAL/ANALOG SIGNAL,  
YOU MUST CONNECT ANTENNA.**

IF YOU NEED ADDITIONAL ASSISTANCE WITH SET-UP OR OPERATING AFTER READING OWNER'S MANUAL, PLEASE CALL TOLL FREE **1-800-256-2487**, OR VISIT OUR WEB SITE AT **<http://www.EmersonAudioVideo.com>**

## WARNING:

TO REDUCE THE RISK OF FIRE OR ELECTRIC SHOCK, DO NOT EXPOSE THIS APPLIANCE TO RAIN OR MOISTURE.



**CAUTION:** TO REDUCE THE RISK OF ELECTRIC SHOCK, DO NOT REMOVE COVER (OR BACK). NO USER SERVICEABLE PARTS INSIDE. REFER SERVICING TO QUALIFIED SERVICE PERSONNEL.

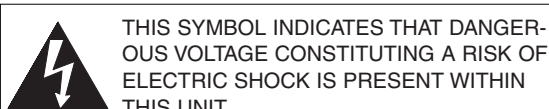

THIS SYMBOL INDICATES THAT DANGEROUS VOLTAGE CONSTITUTING A RISK OF ELECTRIC SHOCK IS PRESENT WITHIN THIS UNIT.



THIS SYMBOL INDICATES THAT THERE ARE IMPORTANT OPERATING AND MAINTENANCE INSTRUCTIONS IN THE LITERATURE ACCOMPANYING THE APPLIANCE.

The important note is located on the rear of the cabinet.

## IMPORTANT SAFEGUARDS

- 1. READ INSTRUCTIONS** - All the safety and operating instructions should be read before the appliance is operated.
- 2. RETAIN INSTRUCTIONS** - The safety and operating instructions should be retained for future reference.
- 3. HEED WARNINGS** - All warnings on the appliance and in the operating instructions should be adhered to.
- 4. FOLLOW INSTRUCTIONS** - All operating and use instructions should be followed.
- 5. CLEANING** - Unplug TV from the wall outlet before cleaning. Do not use liquid cleaners or aerosol cleaners. Use a damp cloth for cleaning. EXCEPTION: A product that is meant for uninterrupted service and, that for some specific reason, such as the possibility of the loss of an authorization code for a CATV converter, is not intended to be unplugged by the user for cleaning or any other purpose, may exclude the reference to unplugging the appliance in the cleaning description otherwise required in item 5.
- 6. ATTACHMENTS** - Do not use attachments not recommended by the TV manufacturer as they may cause hazards.
- 7. WATER AND MOISTURE** - Do not use this TV near water, for example, near a bath tub, wash bowl, kitchen sink, or laundry tub, in a wet basement, or near a swimming pool, and the like.
- 8. ACCESSORIES** - Do not place this TV on an unstable cart, stand, tripod, bracket, or table. The TV may fall, causing serious injury to someone, and serious damage to the appliance. Use only with a cart, stand, tripod, bracket, or table recommended by the manufacturer, or sold with the TV.

Any mounting of the appliance should follow the manufacturer's instructions and should use a mounting accessory recommended by the manufacturer. An appliance and cart combination should be moved with care. Quick stops, excessive force, and uneven surfaces may cause the appliance and cart combination to overturn.

**AMEUBLES** - Cet appareil ne doit être placé que sur un meuble (avec ou sans roulettes) recommandé par le fabricant. Si vous l'installez sur un meuble à roulettes, déplacez les deux ensembles avec précaution. Un arrêt brusque, l'utilisation d'une force excessive et des surfaces irrégulières risquent de déstabiliser l'ensemble et de le renverser.

- 9. VENTILATION** - Slots and openings in the cabinet and the back or bottom are provided for ventilation and to ensure reliable operation of the TV and to protect it from overheating, these openings must not be blocked or covered. The openings should never be blocked by placing the TV on a bed, sofa, rug, or other similar surface. This TV should never be placed near or over a radiator or heat register. This TV should not be placed in a built-in installation such as a bookcase or rack unless proper ventilation is provided or the manufacturer's instructions have been adhered to.
- 10. POWER SOURCES** - This TV should be operated only from the type of power source indicated on the marking label. If you are not sure of the type of power supply to your home, consult your appliance dealer

or local power company. For TVs intended to operate from battery power, or other sources, refer to the operating instructions.

- 11. GROUNDING OR POLARIZATION** - This TV is equipped with a polarized alternating-current line plug (a plug having one blade wider than the other). This plug will fit into the power outlet only one way. This is a safety feature. If you are unable to insert the plug fully into the outlet, try reversing the plug. If the plug should still fail to fit, contact your electrician to replace your obsolete outlet. Do not defeat the safety purpose of the polarized plug.
- 12. POWER-CORD PROTECTION** - Power-supply cords should be routed so that they are not likely to be walked on or pinched by items placed upon or against them, paying particular attention to cords at plugs, convenience receptacles, and the point where they exit from the appliance.
- 13. OUTDOOR ANTENNA GROUNDING** - If an outside antenna or cable system is connected to the TV, be sure the antenna or cable system is grounded so as to provide some protection against voltage surges and built-up static charges. Article 810 of the National Electrical Code, ANSI/NFPA No. 70, provides information with respect to proper grounding of the mast and supporting structure, grounding of the lead-in wire to an antenna discharge unit, size of grounding conductors, location of antenna-discharge unit, connection to grounding electrodes, and requirements for the grounding electrode. (Fig. A)

PORTABLE CART WARNING



S3126A

SYMBOLE D'AVERTISSEMENT POUR LES COMPOSANTES APPAREIL ET MEUBLE A ROULETTES



S3126A

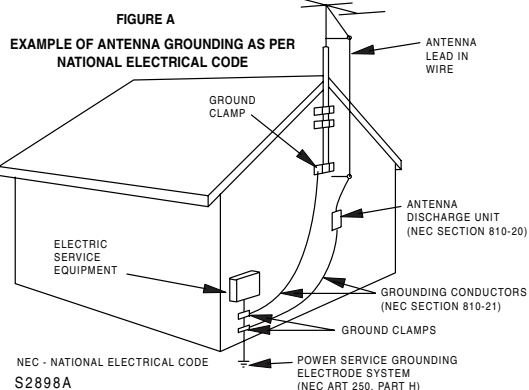

- 14. LIGHTNING** - For added protection for this TV receiver during a lightning storm, or when it is left unattended and unused for long periods of time, unplug it from the wall outlet and disconnect the antenna or cable system. This will prevent damage to the TV due to lightning and power-line surges.
- 15. POWER LINES** - An outside antenna system should not be located in the vicinity of overhead power lines or other electric light or power circuits, or where it can fall into such power lines or circuits. When installing an outside antenna system, extreme care should be taken to keep from touching such power lines or circuits as contact with them might be fatal.

- 16. **OVERLOADING** - Do not overload wall outlets and extension cords as this can result in a risk of fire or electric shock.
- 17. **OBJECT AND LIQUID ENTRY** - Never push objects of any kind into this TV through openings as they may touch dangerous voltage points or short out parts that could result in a fire or electric shock. Never spill liquid of any kind on the TV.
- 18. **SERVICING** - Do not attempt to service this TV yourself as opening or removing covers may expose you to dangerous voltage or other hazards. Refer all servicing to qualified service personnel.
- 19. **DAMAGE REQUIRING SERVICE** - Unplug this TV from the wall outlet and refer servicing to qualified service personnel under the following conditions:
  - a. When the power supply cord or plug is damaged or frayed.
  - b. If liquid has been spilled, or objects have fallen into the TV.
  - c. If the TV has been exposed to rain or water.
  - d. If the TV does not operate normally by following the operating instructions. Adjust only those controls that are covered by the operating instructions, as improper adjustment of other controls may result in damage and will often require extensive work by a qualified technician to restore the TV to its normal operation.
- e. If the TV has been dropped or damaged in any way.
- f. When the TV exhibits a distinct change in performance, this indicates a need for service.
- 20. **REPLACEMENT PARTS** - When replacement parts are required, be sure the service technician uses replacement parts specified by the manufacturer that have the same characteristics as the original part. Unauthorized substitutions may result in fire, electric shock, injury to persons or other hazards.
- 21. **SAFETY CHECK** - Upon completion of any service or repairs to this TV, ask the service technician to perform routine safety checks to determine that the TV is in proper operating condition.
- 22. **HEAT** - This TV product should be situated away from heat sources such as radiators, heat registers, stoves, or other products (including amplifiers) that produce heat.

## PRECAUTIONS

- Place your TV in a room with adequate ventilation.
- Keep your TV set away from sources of direct heat, such as heat registers or direct sunlight.
- Do not place your TV on soft surfaces, such as rugs or blankets.
- Leave enough room for air to circulate around the bottom, top and back of the set.

**(Hg) LAMP IN LCD CONTAINS MERCURY, DISPOSE ACCORDING TO LOCAL, STATE OR FEDERAL LAW.**

**FCC WARNING:** This equipment may generate or use radio frequency energy. Changes or modifications to this equipment may cause harmful interference unless the modifications are expressly approved in the owner's manual. The user could lose the authority to operate this equipment if an unauthorized change or modification is made.

### RADIO-TV INTERFERENCE

This equipment has been tested and found to comply with the limits for a Class B digital device, pursuant to Part 15 of the FCC Rules. These limits are designed to provide reasonable protection against harmful interference in a residential installation. This equipment generates, uses, and can radiate radio frequency energy and, if not installed and used in accordance with the instructions, may cause harmful interference to radio communications. However, there is no guarantee that interference will not occur in a particular installation. If this equipment does cause harmful interference to radio or television reception, which can be determined by turning the equipment off and on, the user is encouraged to try to correct the interference by one or more of the following measures:

- 1) Reorient or relocate the receiving antenna.
- 2) Increase the separation between the equipment and receiver.
- 3) Connect the equipment into an outlet on a circuit different from that to which the receiver is connected.
- 4) Consult the dealer or an experienced radio/TV technician for help.

**This Class B digital apparatus complies with Canadian ICES-003.**

**Cet appareil numérique de la classe B est conforme à la norme NMB-003 du Canada.**

**CAUTION:** TO PREVENT ELECTRIC SHOCK, MATCH WIDE BLADE OF PLUG TO WIDE SLOT, FULLY INSERT.

**ATTENTION:** POUR ÉVITER LES CHOCS ÉLECTRIQUES, INTRODUIRE LA LAME LA PLUS LARGE DE LA FICHE DANS LA BORNE CORRESPONDANTE DE LA PRISE ET POUSSER JUSQU'AU FOND.

**Note to CATV system installer:**

*This reminder is provided to call the CATV system installer's attention to Article 820-40 of the NEC that provides guidelines for proper grounding and, in particular, specifies that the cable ground should be connected to the grounding system of the building as close to the point of cable entry as practical.*

The serial number of this product may be found on the back of the TV. No others have the same serial number as yours. You should record the number and other vital information here and retain this book as a permanent record of your purchase to aid identification in case of theft.

Model No.	Date of Purchase
Serial No.	Dealer Phone No.
Dealer Purchase from	Dealer Address

**A NOTE ABOUT RECYCLING:**

This product's packaging materials are recyclable and can be reused. Please dispose of any materials in accordance with your local recycling regulations. Batteries should never be thrown away or incinerated but disposed of in accordance with your local regulations concerning chemical wastes.

## SUPPLIED ACCESSORIES

- Owner's Manual (1EMN22175)

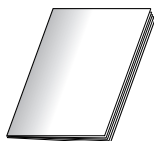

- Remote control unit (NF006UD)



- Batteries ("AA" x 2)



- If you need to replace these accessories, please refer to the PART NO. with the illustrations and call our toll free customer support line found on the cover of this manual.
- Depending on your antenna system, you may need different types of Combiners (Mixers) or Separator (Splitters). Contact your local electronics store for these items.

## FEATURES

### • DTV/TV/CATV

You can use your remote control to select channels which are broadcast in conventional analog, standard definition, and high definition formats. Also, cable subscribers can access their cable TV channels.

### • Program Information Display (DTV only)

You can display the title, contents and other information of the current DTV program on the screen.

### • Autoscanner

This TV can automatically scan and memorize the channels receivable in your residential area. This feature eliminates the need of a difficult setting procedure.

### • V-CHIP

This feature allows you to block children's access to inappropriate programs.

### • Closed Caption Decoder

This TV contains the built-in Closed Caption Decoder that displays text across the screen. It allows you to read the dialogue of a TV program or other information in the Closed Caption-supported programs.

### • MTS/SAP Tuner

This feature allows you to select with the remote control your desired audio language.

### • Auto Shut Off Function

If there is no signal input from the antenna terminal and no operation for 15 minutes, the unit will turn itself off automatically.

### • Choices for On-Screen Menu Language

Select your setup menu language: English, Spanish or French.

### • Stereo Sound Function

### • Full-Function Remote Control

### • PLL Frequency Synthesized Tuning

### • HDMI Input

This TV accepts 480i / 480p / 720p / 1080i video signals and 32kHz / 44.1kHz / 48kHz audio signals.

### • Component VIDEO Input

This TV accepts 480i / 480p / 720p / 1080i video signals.

### • S-VIDEO Input

### • AV Input

### • Analog Audio Output

### • Digital Audio Output (Coaxial)

### • Resume

This feature will automatically memorize settings if a power failure occurs.

© 2007 Funai Electric Co., Ltd.

All rights reserved. No part of this manual may be reproduced, copied, transmitted, disseminated, transcribed, downloaded or stored in any storage medium, in any form or for any purpose without the express prior written consent of Funai. Furthermore, any unauthorized commercial distribution of this manual or any revision hereto is strictly prohibited.

Information in this document is subject to change without notice. Funai reserves the right to change the content herein without the obligation to notify any person or organization of such changes.

**FUNAI** with the  design is a registered trademark of Funai Electric Co., Ltd and may not be used in any way without the express written consent of Funai. All other trademarks used herein remain the exclusive property of their respective owners. Nothing contained in this manual should be construed as granting, by implication or otherwise, any license or right to use any of the trademarks displayed herein. Misuse of any trademarks or any other content in this manual is strictly prohibited. Funai shall aggressively enforce its intellectual property rights to the fullest extent of the law.

# CONTENTS

IMPORTANT SAFEGUARDS .....	2
PRECAUTIONS .....	3
SUPPLIED ACCESSORIES .....	4
FEATURES .....	4
<b>FUNCTIONS .....</b>	<b>6</b>
REMOTE CONTROL, TOP AND REAR PANEL FUNCTION .....	6
INSTALLING THE BATTERIES .....	7
BATTERY PRECAUTIONS .....	7
<b>PREPARATION FOR USE .....</b>	<b>8</b>
CONNECTION .....	8
ANTENNA CABLE CONNECTION .....	8
CONNECTION TO CABLE/SATELLITE BOX .....	8
CONNECTING OTHER DEVICES .....	9
HDMI .....	9
COMPONENT CABLE CONNECTION .....	10
S-VIDEO CABLE CONNECTION .....	10
VIDEO CONNECTION .....	11
DIGITAL AUDIO CONNECTION .....	11
ANALOG AUDIO CONNECTION .....	11
<b>INITIAL SETTINGS .....</b>	<b>12</b>
INITIAL SETUP .....	12
<b>CHANNEL SETTINGS .....</b>	<b>13</b>
AUTOSCAN .....	13
CHANNEL LIST .....	14
MANUAL REGISTER .....	15
ANTENNA CONFIRMATION .....	16
LANGUAGE SELECTION .....	17
<b>WATCHING TV .....</b>	<b>18</b>
CHANNEL SELECTION .....	18
VOLUME ADJUSTMENT .....	18
STILL MODE .....	19
SELECTING AUDIO CHANNELS .....	19
ACCESSING EXTERNAL DEVICES .....	20
CHANGING THE SCREEN DISPLAY MODE .....	21
SCREEN INFORMATION .....	22
SLEEP TIMER .....	23
<b>OPTIONAL SETTINGS .....</b>	<b>23</b>
SETUP SCREEN .....	23
PICTURE ADJUSTMENT .....	24
CLOSED CAPTION .....	25
DTV CLOSED CAPTION .....	26
CLOSED CAPTION STYLE .....	26
V-CHIP .....	28
HDMI AUDIO .....	31
<b>MISCELLANEOUS .....</b>	<b>32</b>
TROUBLESHOOTING GUIDE .....	32
GLOSSARY .....	34
MAINTENANCE .....	34
<b>SPECIFICATIONS .....</b>	<b>35</b>
<b>WARRANTY .....</b>	<b>Back cover</b>

## SYMBOLS USED IN THIS MANUAL

The following is the description for the symbols used in this manual.

 : Analog TV operation.

 : Digital TV operation.

• If neither symbol appears under the function heading, operation is applicable to both.

# FUNCTIONS

## REMOTE CONTROL, TOP AND REAR PANEL FUNCTION

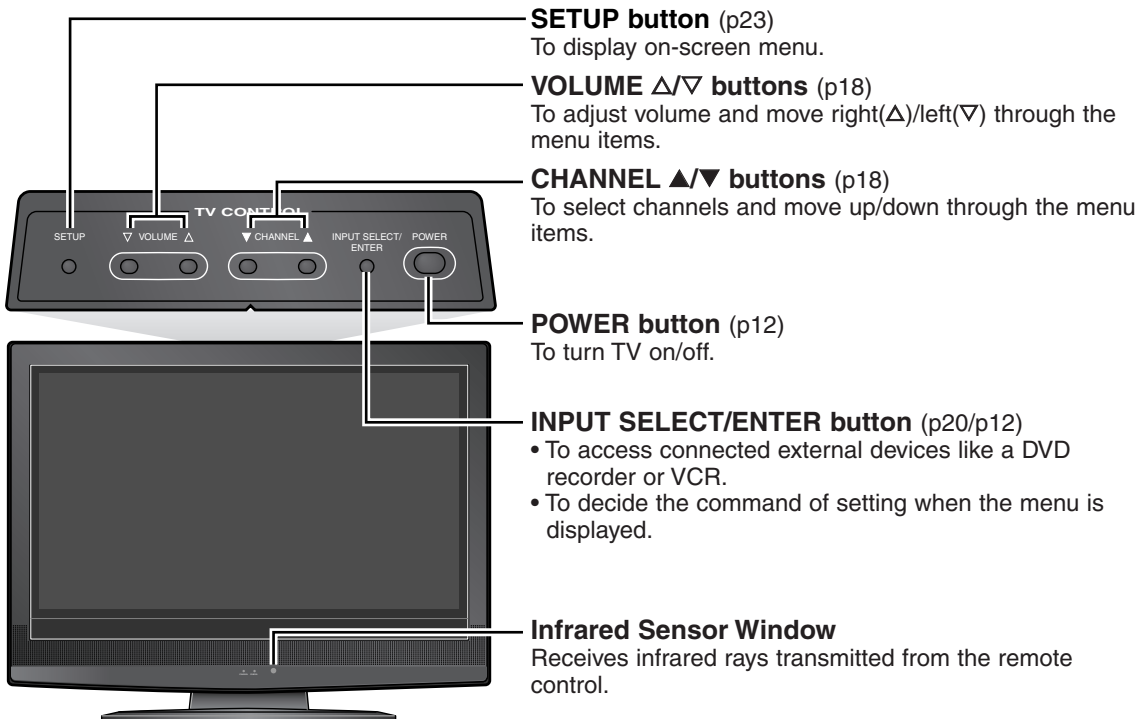
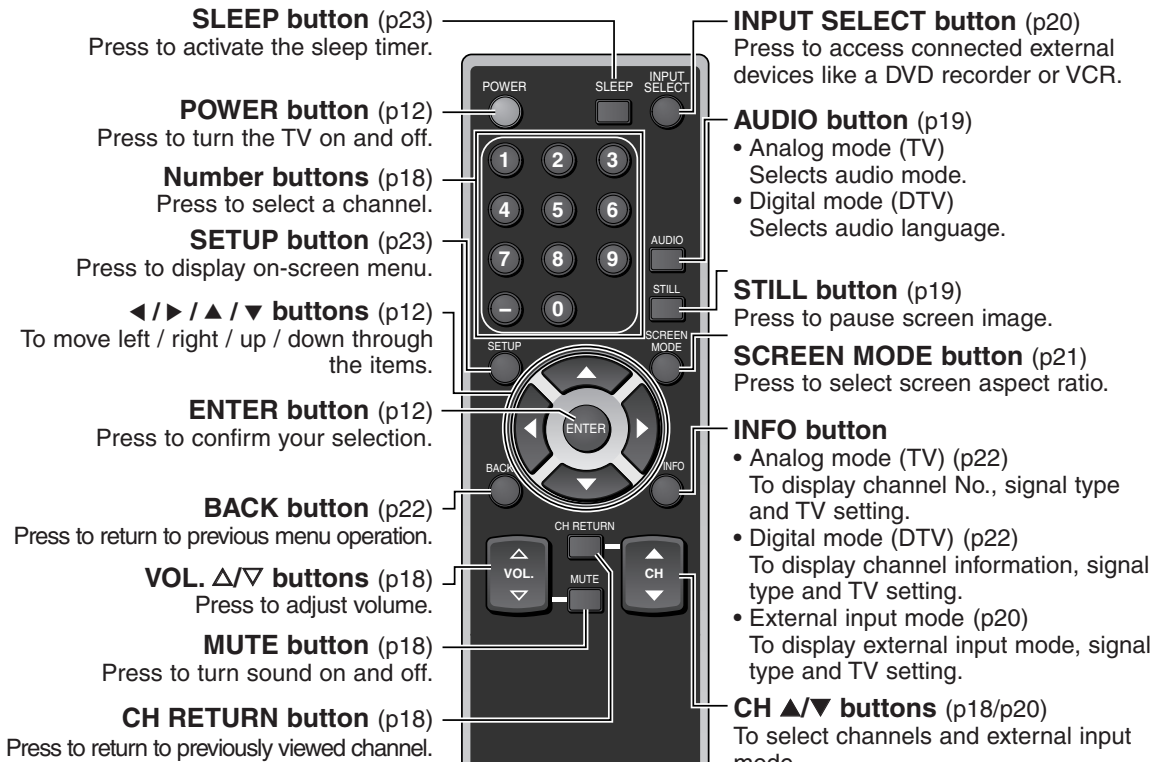

**NOTE:**

• With buttons [VOL. Δ/∇] or [MUTE], you can only adjust the volume of the main unit. You cannot adjust the volume of the external devices with these buttons.

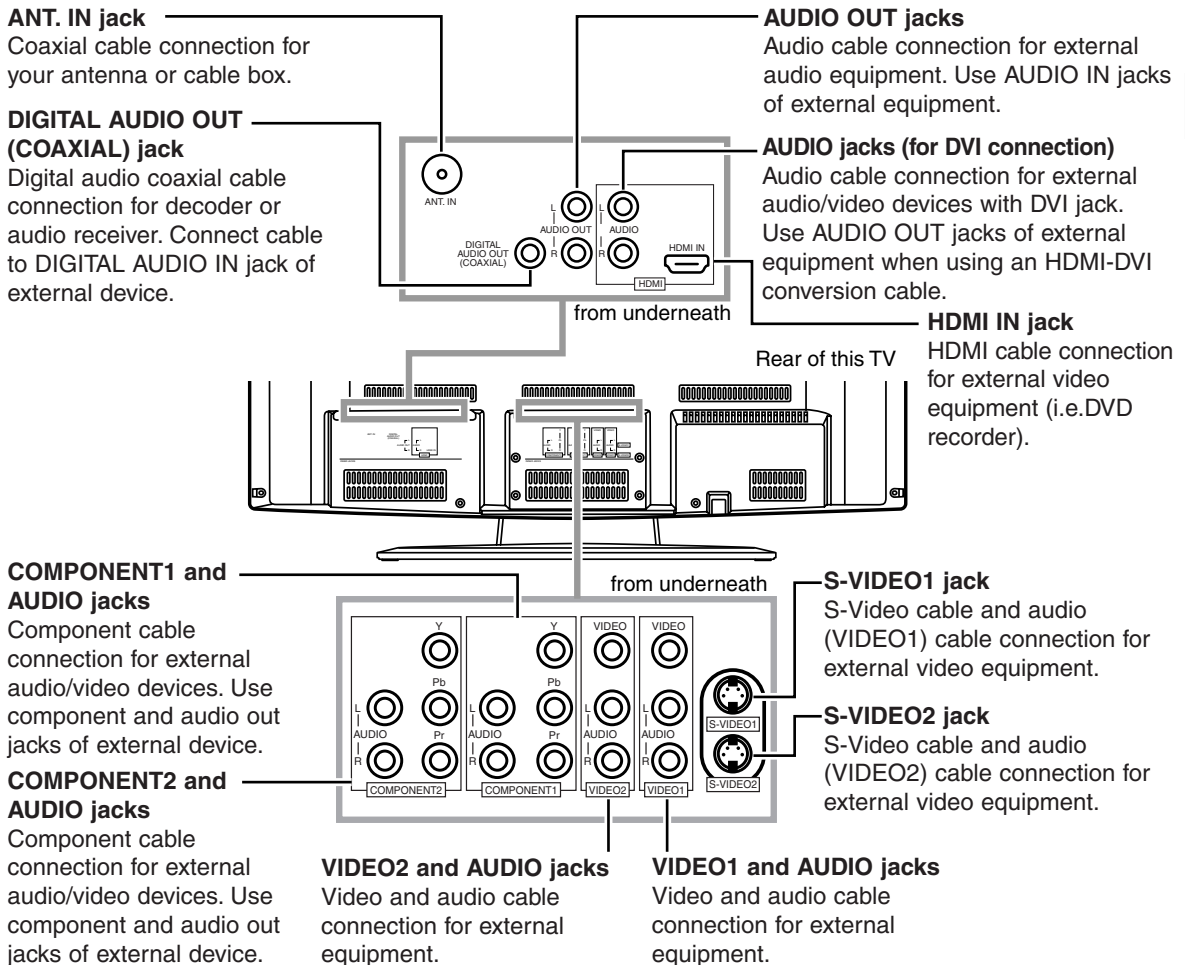

## INSTALLING THE BATTERIES

Install two AA batteries (included) matching the polarity (++) / (--) indicated inside battery compartment of the remote control.

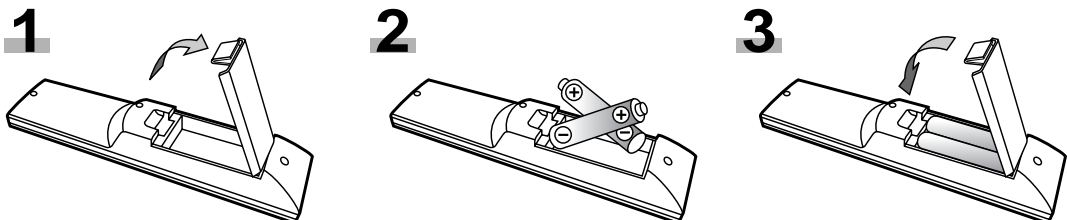

### [BATTERY PRECAUTIONS]

- Be sure to follow the correct polarity as indicated in the battery compartment. Reversed batteries may cause damage to the device.
- Do not mix different types of batteries together (e.g. Alkaline and Carbon-Zinc) or old batteries with fresh ones.
- If the device is not to be used for a long period of time, remove the batteries to prevent damage or injury from possible battery leakage.
- Do not try to recharge batteries not intended to be recharged; they can overheat and rupture.

# PREPARATION FOR USE

## CONNECTION

This section describes how to connect your TV to an antenna, cable box, etc.

**MAKE SURE YOU HAVE AN ANTENNA.**

**As DTV is only available over the air, you need an antenna to receive a digital signal.**

**NOTE:**

- Be sure your antenna or other source is connected properly before plugging in the power cord.

### [ANTENNA CABLE CONNECTION]

1) When connecting your TV to an antenna

Connect the Coaxial cable on your home outlet to the ANT. IN jack of this TV.

2) When connecting TV to cable TV company (without box)

Connect the Coaxial cable on your home outlet to the ANT. IN jack of this TV.

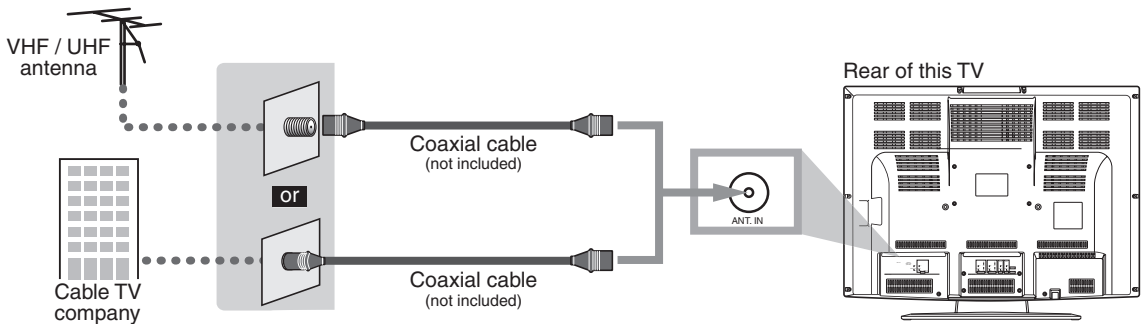

\*Once connections are completed, turn on the TV and begin initial setup.

Channel scanning is necessary for the TV to memorize all available channels in your area.

(Refer to "INITIAL SETUP" on page 12.)

**NOTES:**

- For your safety and to avoid damage to equipment, please unplug the coaxial cable from the ANT.IN jack before moving the unit.
- If you use an antenna in order to receive analog TV, the same antenna generally will work for DTV reception. Outdoor or attic antennas will be more effective than set-top versions.
- To easily switch between antenna and cable wires, you can purchase an "Antenna Selector" commercially available.
- If you connect a cable system directly, contact the CATV installer.

### [CONNECTION TO CABLE/SATELLITE BOX]

1) Connect the coaxial cable on your home outlet to the input jack of the CABLE/SATELLITE box.

2) Use another coaxial cable to connect the ANT. IN jack of your TV to the output jack of the CABLE/SATELLITE box.

\*Required cables in 2) and connecting methods differ depending on the CABLE/SATELLITE box. For more information, please contact your cable/satellite provider.

Ex.

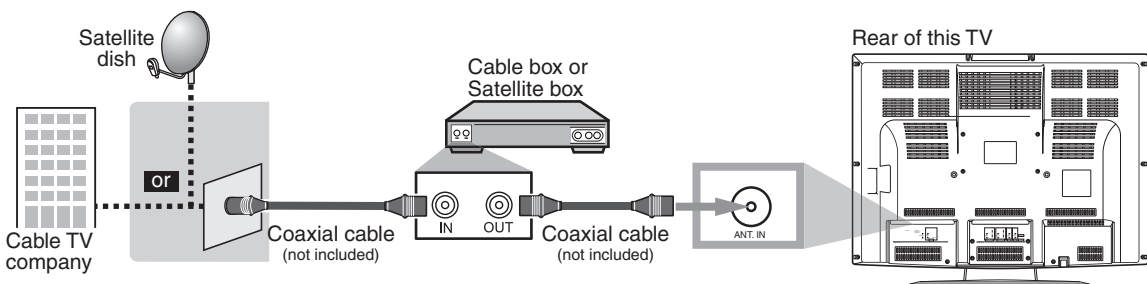



## CONNECTING OTHER DEVICES

### [HDMI]

1) High Definition Multimedia Interface (HDMI) uses the latest technology to ensure the signal maintains the highest degree of integrity from source to TV. Both video and audio travel through a single cable.

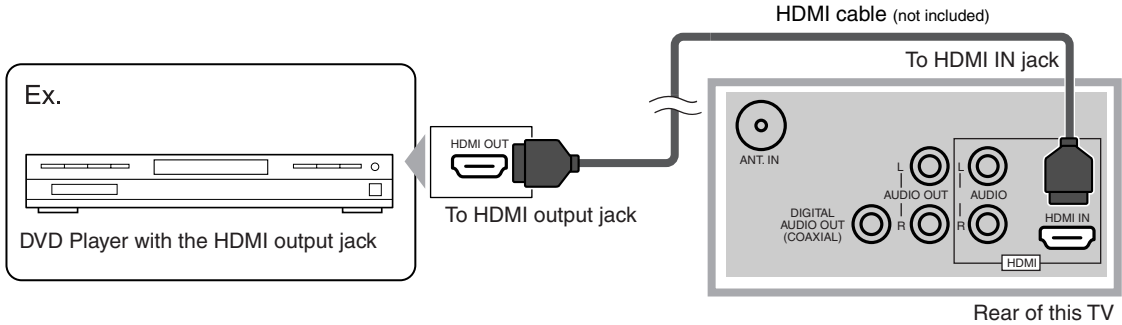

#### NOTES:

- This TV accepts 480i / 480p / 720p / 1080i video signals, and 32kHz / 44.1kHz / 48kHz audio signals.
- This TV accepts only 2 channel audio signal (LPCM).
- You need to select "PCM" for the digital audio output of the device you connect or the HDMI audio setting. Audio sometimes makes no sound if you select "Bitstream", etc.
- This TV only accepts signals corresponding EIA861.

2) When your video device has a DVI output jack, connect the HDMI conversion cable (not included) from the DVI output jack.

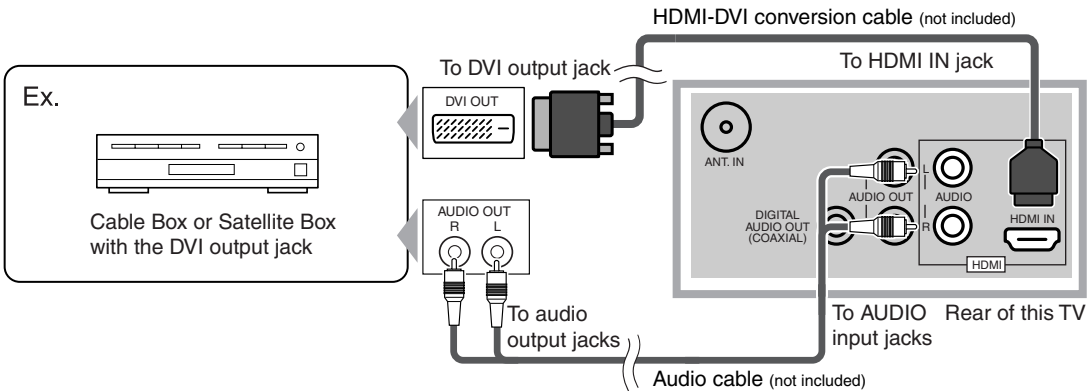

#### NOTES:

- This TV accepts 480i / 480p / 720p / 1080i video signals.
- An HDMI conversion cable requires a separate audio cable connection as well.
- Audio signals are converted from digital to analog if you make the connection in paragraph 2) above.
- DVI does not show image if the 480i does not accept EIA/CEA-861/861B.

**"HDMI, the HDMI logo and High-Definition Multimedia Interface are trademarks or registered trademarks of HDMI Licensing LLC."**

### [COMPONENT CABLE CONNECTION]

Offers better picture quality for video devices connected to your TV.

Use a component video cable (not included) to connect your TV to external video devices equipped with component video jacks.

If you connect to your TV's COMPONENT1 input jack, connect audio cables to the AUDIO L/R jacks of COMPONENT1.

If you connect to your TV's COMPONENT2 input jack, connect audio cables to the AUDIO L/R jacks of COMPONENT2.

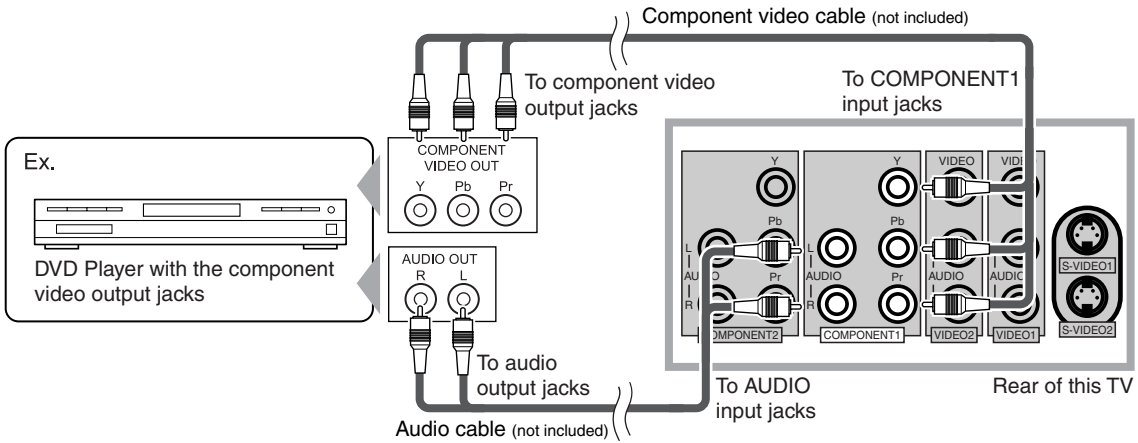

#### **NOTE:**

- This TV accepts 480i / 480p / 720p / 1080i video signals.

### [S-VIDEO CABLE CONNECTION]

Offers good picture quality for video devices connected to your TV.

Use an S-video cable (not included) to connect your TV to external video devices equipped with S-video connectors.

If you connect to your TV's S-VIDEO1 input jack, connect audio cables to the AUDIO L/R jacks of VIDEO1.

If you connect to your TV's S-VIDEO2 input jack, connect audio cables to the AUDIO L/R jacks of VIDEO2.

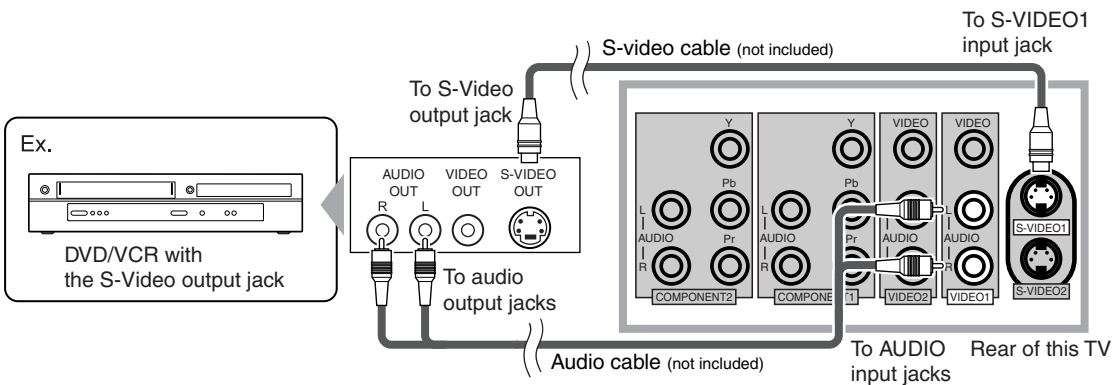

#### **NOTE:**

- If you connect to the S-VIDEO jack and the VIDEO jack at the same time, the S-video connection will have priority.

**[VIDEO CONNECTION]**

Offers standard picture quality for video devices connected to your TV.

When the audio jack of the video device is monaural, connect the audio cable to the audio L input jack.

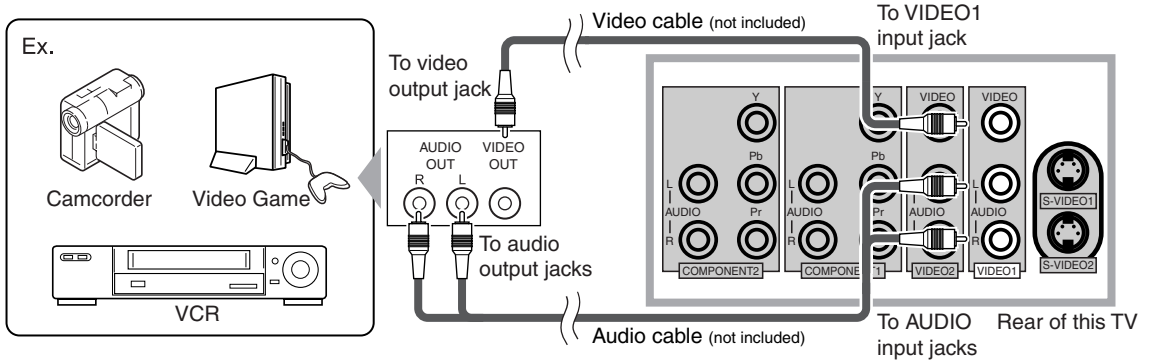

**[DIGITAL AUDIO CONNECTION]**

If you connect this TV to an external digital audio device, you can enjoy multi-channel audio like 5.1ch digital broadcasting sound. Required digital audio coaxial cable not included.

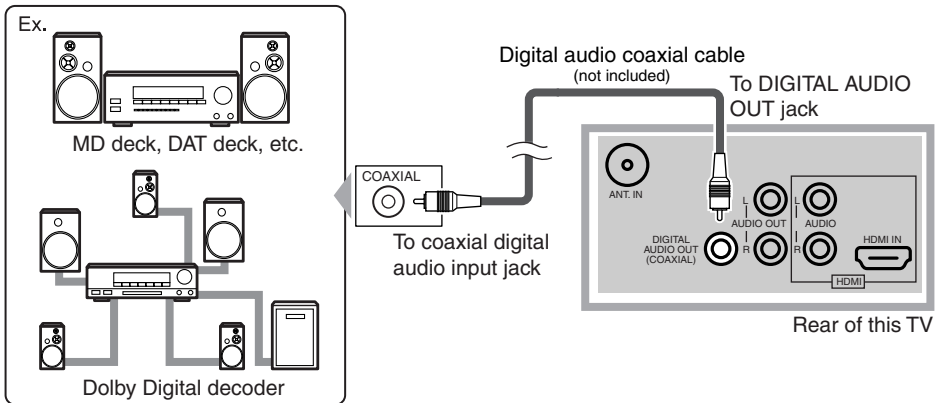

**Manufactured under license from Dolby Laboratories. "Dolby" and the double-D symbol are trademarks of Dolby Laboratories.**

**[ANALOG AUDIO CONNECTION]**

If you connect this TV to an external analog audio device, you can enjoy stereophonic (2 channel) audio sound. Required audio cable not included.

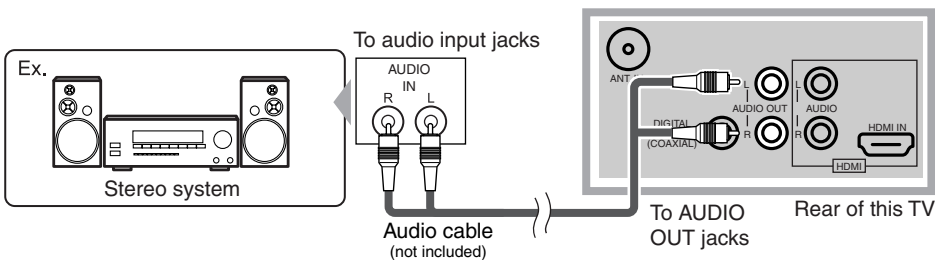

# INITIAL SETTINGS

## INITIAL SETUP

This section will guide you through your TV's initial set up which includes selecting a language for your on-screen menu and AUTOSCAN, which automatically scans and memorizes viewable channels.



**1** After making all the necessary connections, turn on your TV.

**2** Press **[POWER]**. Initial Setup menu will appear.

- This operation may take a few moments.
- If Initial Setup menu does not appear, press and hold **[ENTER]** for 3 seconds, initial setup will appear then proceed to step 3. If initial set up has already been completed, refer to "LANGUAGE SELECTION" on page 17.

**3** When you first turn on your TV, the following screen is displayed. Use **[▲/▼]** to select the on-screen menu language from the choices on the right side of the screen.



The Antenna Confirmation menu on step 4 will be displayed in the selected language after you press **[ENTER]**.

**4** Select source of ANT. IN jack using **[▲/▼]**, then press **[ENTER]**.

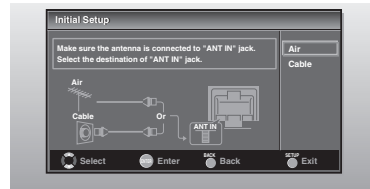

**5** Autoscanner will start automatically.

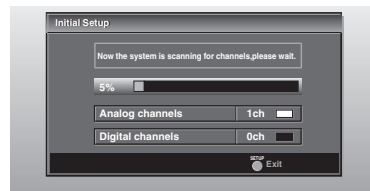

- When scanning has completed, the lowest memorized channel will be displayed.

### NOTES:

- The initial Autoscan function can be executed for either "Air" or "Cable" only once. When you change the connection (Air/Cable), set the "Autoscan" again. (Refer to page 13.)
- If you connect a cable system directly, contact the CATV installer.
- When the scanning is not complete, Helpful Hint will be displayed every time you turn on the power. If you have previously registered channels when this screen appears you can select a channel with **[the Number buttons]**.



- Toll free customer support line can be found on the cover of this manual.

# CHANNEL SETTINGS

## AUTOSCAN

With AUTOSCAN, your TV automatically scans and memorizes your area's viewable channels. Activate AUTOSCAN when you turn on your TV for the first time, change broadcast sources (e.g. from antenna to CATV), or move your TV to a different broadcast area.

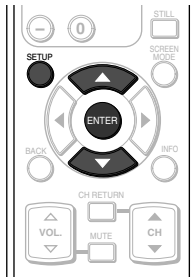

**NOTE:**

- Make sure the TV is connected to antenna or cable.

**1** Display the setup screen.

- Press **[SETUP]**.  
The following setup screen appears.



**2** Select "CHANNEL" and press **[ENTER]** to confirm.

- Using **[▲/▼]**, select "Autoscan".



- Press **[ENTER]**.

**3** For TV channels, using **[▲/▼]**, select "Air".  
For CATV channels, select "Cable".

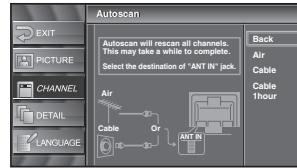

- Press **[ENTER]**.  
Scanning and memorizing the channels automatically starts.

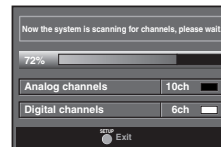

- When the scanning and memorizing are completed, the lowest memorized channel in the broadcasting will be displayed.

**NOTES:**

- If you connect a cable system directly, contact the CATV installer.
- If you press **[POWER]** or **[SETUP]** during Autoscan, this setting will be canceled.
- If there is no reception connected or a poor signal is detected, a Hint will appear on screen once scanning stops.

## CHANNEL LIST

This function lets you remove undesired channels from the Channel Registration List.

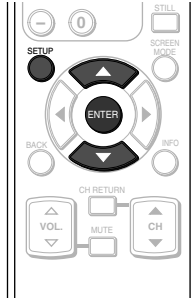

### 1 Display the setup screen.

- Press **[SETUP]**.  
The following setup screen appears.



### 2 Select "CHANNEL" and press **[ENTER]** to confirm.

- Using **[▲/▼]**, select "Channel List".

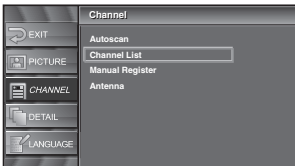

- Press **[ENTER]**.

### 3 Select the channel you want to remove.

- Using **[▲/▼]**, select the channel.



- Press **[ENTER]** to highlight the channel selected for removal. You will not be able to select the channel again using **[CH ▲/▼]**.
- To reactivate the removed channel, highlight it and press **[ENTER]**.
- When you remove a major channel, you remove its minor channels, too.

#### **NOTE:**

- The channel with "DTV" indicated on the display is ATSC, otherwise the channel is NTSC.

### 4 To exit the setup, press **[SETUP]**.

## MANUAL REGISTER

This function lets you manually add channels not memorized due to poor broadcast strength during AUTOSCAN.



### 1 Display the setup screen.

- Press **[SETUP]**.  
The following setup screen appears.



### 2 Select "CHANNEL" and press **[ENTER]** to confirm.

- Using **[▲/▼]**, select "Manual Register".

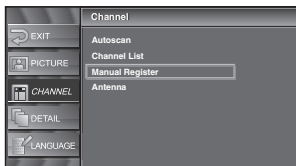

- Press **[ENTER]**.

### 3 Select the channel you want to add.

- Using **[the Number buttons]**, select your desired channel.

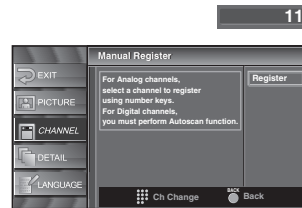

- Select "Register" with **[ENTER]**.

### 4 To exit the setup, press **[SETUP]**.

#### NOTES:

- If set up completes successfully, "Registered to the Channel List" is displayed.
- If Video 1 is being used, set up will not be completed successfully and "Unavailable" will be displayed on the screen.

## ANTENNA CONFIRMATION

Displays signal strength for each channel.



- If the channel is set to external input, you cannot confirm the antenna situation.

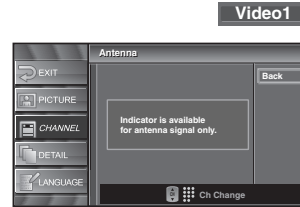

**3** To exit the setup, press **[SETUP]**.

**1** Display the setup screen.

- Press **[SETUP]**.  
The following setup screen appears.



**2** Select "CHANNEL" and press **[ENTER]** to confirm.

- Using **[▲/▼]**, select "Antenna".

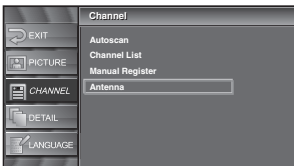

- Press **[ENTER]**.
- Using **[the Number buttons]** or **[CH ▲/▼]**, select the channel for which you want to check signal strength.

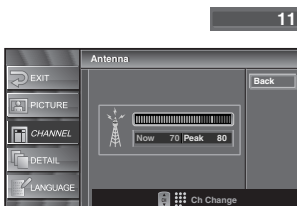

11



## LANGUAGE SELECTION

You can choose English, Spanish, or French as your on screen language.

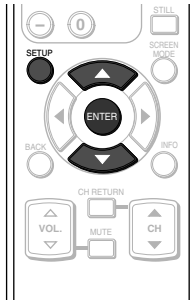

**1** Display the setup screen.

- Press **[SETUP]**.  
The following setup screen appears.



**2** Select "LANGUAGE" and press **[ENTER]** to confirm.

- Using **[▲/▼]**, select "English", "Español" or "Français".



- Press **[ENTER]**.

**3** To exit the setup, press **[SETUP]**.

## CHANNEL SELECTION

Select channels by pressing **[CH ▲/▼]** found on remote control or on the TV's control panel, or by pressing **[the Number buttons]** found on the remote control.



### [CH ▲/▼]

- Use **[CH ▲/▼]** to change the channel.
- Same operation is also available with **[CHANNEL ▲/▼]** on the top panel of the main unit.

### [the Number buttons]

- Press the channel number with **[the Number buttons]** to select a channel you want to watch, then press **[ENTER]**.
  - When selecting analog channel 12
    - 1 → 2 → ENTER
  - When selecting digital channel 12-1
    - Be sure to press **[-]** before entering the minor channel number.
    - 1 → 2 → - → 1 → ENTER
- If the channel broadcasts NTSC and ATSC both and you don't press **[-]**, you will receive the NTSC channel only. The moment you press **[-]**, the lowest memorized digital channel will be displayed.
- Press **[CH RETURN]** to return to the previously viewed channel.

### NOTE:

In DTV broadcasting, one channel sometimes broadcasts multiple programs depending on the air time. In this case, the main channel is called major channel and the minor channel is called minor channel.

### About minor channel broadcasting:

There may be different programs being broadcast on minor channels through a single channel from ATSC. You can watch each minor channel program being broadcast by selecting one of the minor channels.

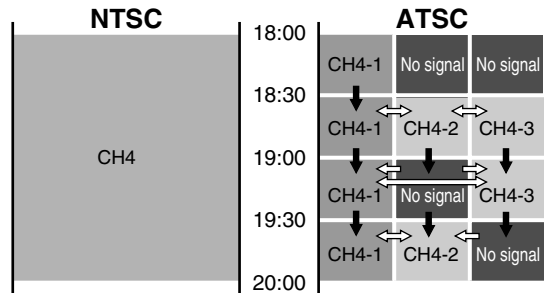

- ➔ : change automatically
- ⇔ : change manually by pressing **[CH ▲ / ▼]** on your remote control

### NOTE:

- "No Signal" will appear on the screen after the minor channel broadcast is over. You will need to change the channel to continue watching another TV program.

## VOLUME ADJUSTMENT

This section describes how to adjust the volume. The mute function, which turns the sound off and on, will also be described.

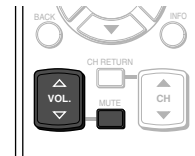

### [VOL. ▲/▼]

- Use **[VOL. ▲/▼]** to adjust the audio volume.
- The same operation is available with **[VOLUME ▲/▼]** on the top panel of the main unit.
- The volume bar will be displayed at the bottom of the screen when adjusting the volume.



- The volume bar display will automatically disappear in a few seconds.

### [MUTE]

- Press **[MUTE]** to turn off and on the sound.



- "Mute" is displayed on the screen for a few seconds.
- Press **[MUTE]** again or **[VOL. ▲/▼]** (**[VOLUME ▲/▼]**) to release the Mute status.

## STILL MODE

You can freeze the image shown on the screen.

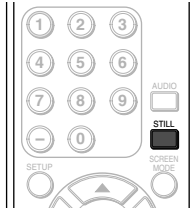

### 1 Pause the image.

- When you press **[STILL]**, the image shown on the screen is paused.



- The audio is not paused and keeps on reading out.
- If the digital signal is gone or protected, the image will remain paused and the audio will be muted.
- The Still function will be released after 5 minutes.

### 2 Canceling Still function.

- The Still function will be canceled by pressing any button while Still function is working.

#### NOTE:

- Press any key except **[POWER]** to cancel still mode.

## SELECTING AUDIO CHANNELS

This section describes how to switch the audio in the analog mode and how to switch the audio language in the digital mode.



TV

When you press **[AUDIO]**, the currently selected audio mode will be displayed on the screen.



Press **[AUDIO]** to cycle through available audio channels.

When the broadcasting has all audio...



When the broadcasting has stereo audio and monaural audio...



When the broadcasting has SAP and monaural audio...



When the broadcasting is having only monaural audio...



STEREO : Outputs stereo-audio

SAP : Outputs second audio program

MONO : Outputs mono-audio

DTV

When you press **[AUDIO]**, the currently selected language and the number of available languages will be displayed on the screen.

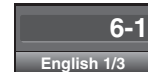

Press **[AUDIO]** to cycle through available audio languages.

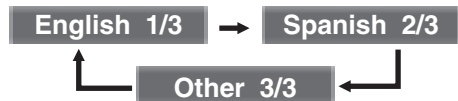

- Available languages differ depending on the broadcast.
- The information display will automatically disappear in one minute.

#### NOTE:

- Pressing **[AUDIO]** does not control external audio source.

## ACCESSING EXTERNAL DEVICES

Use your remote control to access DVD recorders, home audio systems and other external devices when they are connected to your television.

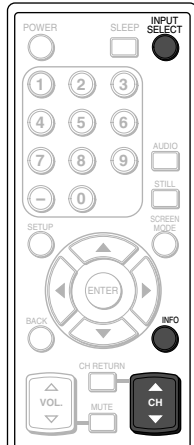

Use your remote control to select external component.

- When you press **[INPUT SELECT]** or **[CH ▼]** on the remote control, the input mode will be switched as below.

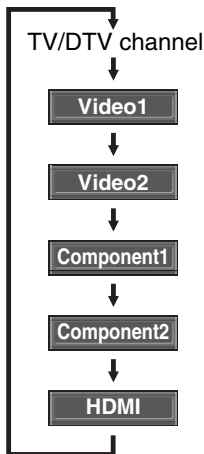

- Pressing **[CH ▲]** on the remote control reverses direction.
- To use the VIDEO1 or S-VIDEO1 input jack on the TV, select "Video1".
- To use the VIDEO2 or S-VIDEO2 input jack on the TV, select "Video2".
- To use the COMPONENT1 input jacks on the TV, select "Component1".
- To use the COMPONENT2 input jacks on the TV, select "Component2".
- To use the HDMI IN jack on the TV, select "HDMI".

- When you press **[INFO]**, the current external input mode, the type of resolutions for video signal, TV aspect ratio, CC and TV rating will be displayed at the top-right of the screen.
- The information display will automatically disappear in 1 minute.

1) When using VIDEO1 or S-VIDEO1 input jack



2) When using VIDEO2 or S-VIDEO2 input jack



3) When using COMPONENT1 input jacks



4) When using COMPONENT2 input jacks



5) When using HDMI IN jack



## CHANGING THE SCREEN DISPLAY MODE

Each of 4 display modes can be selected in either 4:3 or 16:9 aspect ratios.

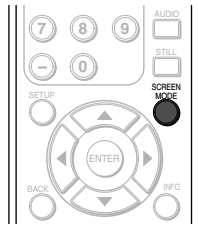

**1** Press **[SCREEN MODE]**, to switch the TV aspect ratio.

**2** Press **[SCREEN MODE]** repeatedly until the normal screen displays.

**NOTE:**

• Some programs may not offer all display mode options.

When the broadcast is sending 4:3 video signal...

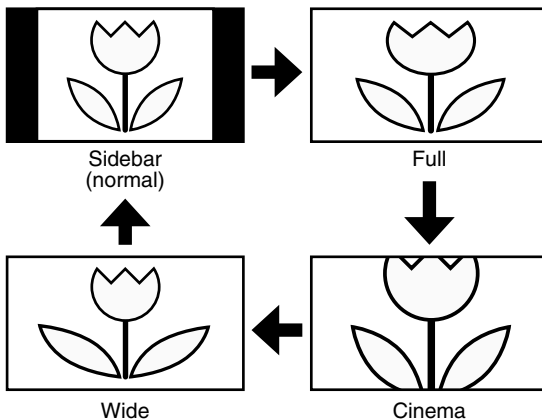

**[Sidebar]**

Sidebar displays a 4:3 picture at its standard 4:3 size. Sidebars will be displayed on the right and left edges of the screen.

**[Full]**

Full displays a 4:3 picture at a 16:9 size, with horizontal elongation necessary to fill the screen.

**[Cinema]**

Cinema displays a 4:3 picture at a 16:9 size, with less horizontal elongation necessary to fill the screen because a little bit of the top and bottom edge of the screen will be cut off.

**[Wide]**

Wide displays the center of the picture as original size and the outer sides of the picture will be elongated. The size of the picture will depend on the original signal.

When the broadcast is sending 16:9 video signal...

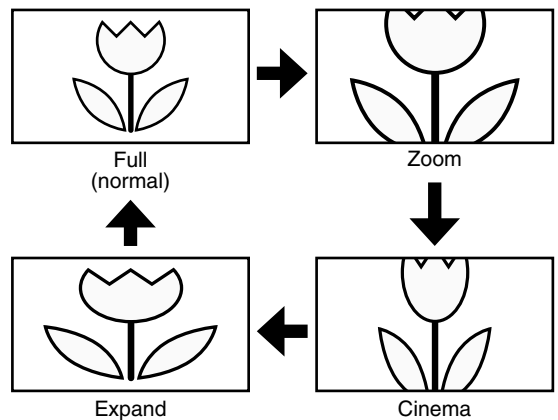

**[Full]**

A picture is displayed at 16:9 size as it is.

**[Zoom]**

Zoom displays a 16:9 picture without changing its horizontal and vertical ratio, at its maximum size.

**[Cinema]**

Cinema displays a 16:9 picture with vertical elongation.

**[Expand]**

Expand displays a 16:9 picture with horizontal elongation.

## SCREEN INFORMATION

You can display the currently selected channel or other information such as the audio mode on the screen.

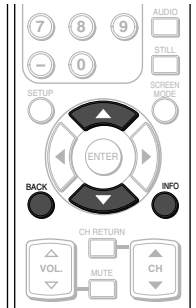

### TV

In the analog mode, the current channel and the audio mode are displayed.

1 Display the channel number and the audio mode.

- Press **[INFO]** on the remote control. The current channel number, audio mode, type of resolutions for video signal, TV aspect ratio, CC and TV rating are displayed at the top-right of the screen.



- To clear the display, press **[BACK]** or **[INFO]** again.

### DTV

In the digital mode, the detailed information for the current channel such as the Program guide is displayed.

1 Display the detailed information for the channel.

- Press **[INFO]** on the remote control. The currently selected program details are displayed on the screen.
- The following information is displayed.
  - (1) Program title
  - (2) Broadcast station
  - (3) Program guide (max. 4 lines displayed)
  - (4) Channel number
  - (5) Audio language ("Other" is displayed when the audio language cannot be acquired, or the acquired languages are other than English, Spanish or French.)
  - (6) Effective scanning lines and scan mode
  - (7) Program definition
  - (8) Program aspect ratio
  - (9) Program rating
  - (10) CC (Not available if the CC set to "Off")

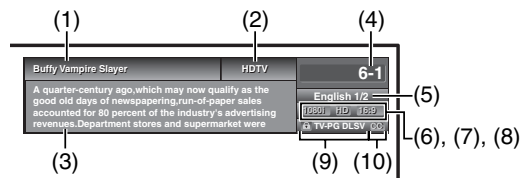

#### NOTES:

- When the program guide is displayed in more than 4 lines, use **[▲/▼]** to scroll.
- "No description provided" is displayed when the program guide is not provided.

- The following screen is displayed when connecting to external devices:
  - e.g.) When using VIDEO1 input jack for connection (Refer to "ACCESSING EXTERNAL DEVICES" on page 20.)



## SLEEP TIMER

The Sleep Timer can be set to automatically turn off your television after an incremental period of time.



**1** Press **[SLEEP]** on the remote control to set the Sleep Timer.

- The setting display for Sleep Timer is shown on the screen.



**2** You can set your TV to turn off after a set period of time (from 10 to 90 minutes). After set up, you can display the remaining time before shut off by pressing **[SLEEP]** again.

- To cancel the sleep timer, press **[SLEEP]** repeatedly until "Sleep Off" is displayed.



- The Sleep Timer setting display will automatically disappear in a few seconds.

**NOTE:**

- When you disconnect your TV from its power source or when a power failure occurs, the sleep timer setting will be cancelled.

## SETUP SCREEN

This section describes the overview of the setup screen displayed when you press **[SETUP]**. For more details, see the reference page for each item.

The setup screen consists of the function setting items below.

- EXIT

To exit settings.

- PICTURE

You can adjust the picture quality (Picture Mode, Brightness, Contrast, Color, Tint, Sharpness, Color Temp., and Energy Saving). (Refer to "PICTURE ADJUSTMENT" on page 24.)

- CHANNEL

You can automatically scan the viewable channels and remove those that are undesired. (Refer to "AUTOSCAN" on page 13.)

- DETAIL

You can change closed captioning display formats and font styles. (Refer to "CLOSED CAPTION" on page 25.)

Block children's access to inappropriate programming. (Refer to "V-CHIP" on page 28.)

And select HDMI Audio if your TV is connected to a digital external device like a DVD recorder. (Refer to "HDMI AUDIO" on page 31.)

- LANGUAGE

You can change the language (English, Spanish, French) displayed on the setup screen.

(Refer to "LANGUAGE SELECTION" on page 17.)

**NOTE:**

- To cancel the setup screen, press **[SETUP]**.

## PICTURE ADJUSTMENT

You can select from four default picture color settings. You can also adjust brightness, contrast, color, tint, sharpness and color temperature as well as energy saving settings.



### 1 Display the setup screen.

- Press **[SETUP]**.  
The following setup screen appears.



### 2 Select "PICTURE", and press **[ENTER]** to confirm.

- Using **[▲/▼]**, select your desired item and press **[ENTER]** to confirm.

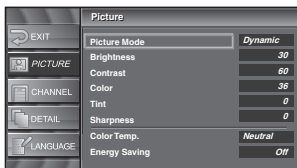

### 3 Adjust the picture quality.

- Using **[▲/▼]**, select the picture quality you want to adjust.

#### Picture Mode

Using **[▲/▼]**, adjust Picture Mode from the selection, then press **[ENTER]**. (Standard, Dynamic, Movie, News and Manual)

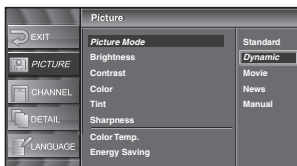

#### Brightness

Using **[◀/▶]**, adjust until the darkest parts of the picture are as bright as you prefer.

- ◀: To decrease brightness
- ▶: To increase brightness



#### Contrast

Using **[◀/▶]**, adjust to increase or decrease contrast.

- ◀: To decrease contrast
- ▶: To increase contrast



#### Color

Using **[◀/▶]**, adjust to be brilliant or pale color.

- ◀: To pale
- ▶: To brilliant



#### Tint

Using **[◀/▶]**, adjust to obtain natural skin tones.

- ◀: To red
- ▶: To green



#### Sharpness

Using **[◀/▶]**, adjust the detail of the picture.

- ◀: To soft
- ▶: To clear



#### Color Temp.

Using **[▲/▼]**, adjust Color Temperature from the selection, then press **[ENTER]**. (Cool, Neutral and Warm)

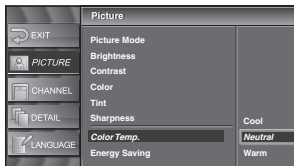

#### Energy Saving

Using **[◀/▶]**, adjust brightness of backlight.

- ◀: To bright
- ▶: To dark



- The adjustment bar for picture quality item is displayed on the screen.

#### NOTE:

- To cancel the picture adjustment, press **[SETUP]**.

### 4 To exit the setup, press **[SETUP]**.



## CLOSED CAPTION

You can view closed captioning (cc) for TV programs, movies, news, and prerecorded tapes. Closed captions refer to text of dialogue or descriptions displayed on-screen for the hearing impaired.

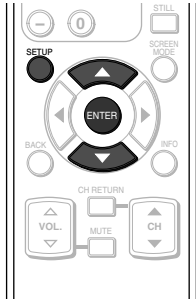

### 1 Display the setup screen.

- Press **[SETUP]**.  
The following setup screen appears.



### 2 Select "DETAIL" and press **[ENTER]** to confirm.

- Using **[▲/▼]**, select "Closed Caption" and press **[ENTER]** to confirm.



### 3 Select "Conventional CC" and press **[ENTER]** to confirm.

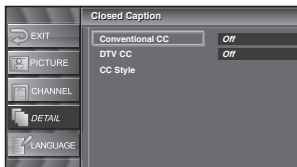

### 4 Select the Closed Caption mode.

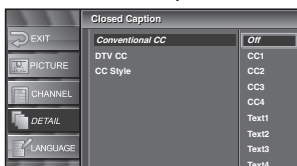

- Using **[▲/▼]**, select the desired closed caption, then press **[ENTER]**.

### [Caption Mode]

#### CC1 and Text1:

are the primary caption and text services. The captioning or text is displayed in the same language as the program's dialogue (up to 4 lines of script on the screen, where it does not obstruct relevant parts of the picture).

#### CC3 and Text3:

serve as the preferred data channels. The captioning or text is often a secondary language translation, simplified English or displayed at a slower rate.

#### CC2, CC4, Text2 and Text4:

are rarely available and broadcasters use them only in special conditions, such as when CC1 and CC3 are not available or Text1 and Text3 are not available.

- There are three display modes according to programs:

**Paint-on mode** : Displays input characters on the screen immediately.

**Pop-on mode** : Once characters are stored in memory, they are displayed all at once.

**Roll-up mode** : Displays the characters continuously by scrolling (max. 4 lines).

### 5 To exit the setup, press **[SETUP]**.

#### NOTES:

- Closed captions must be broadcast or included in your recorded content to appear on your TV.
- Closed captions will not be displayed when you are using an HDMI connection.
- If the closed caption is not broadcasted, nothing is displayed.
- The closed caption is not displayed when you use HDMI connection.
- When your TV receives a special effects playback signal (i.e., Search, Slow and Still) from a VCR's video output channel (CH3 or CH4), the TV may not display the correct caption or text.
- Captions and texts may not match the TV voice exactly.
- Interference may cause the closed caption system not to function properly.
- The caption or text characters will not be displayed while the menu display or functions display is shown.
- If a black box appears on the screen, this means that the TV is set to TEXT mode. To clear screen, select CAPTION "CC1", "CC2", "CC3", "CC4" or "Off".

## DTV CLOSED CAPTION

### DTV

Apart from closed captions, DTV has its own closed captions called DTV CC. Use this menu to change the settings for DTV CC.

1 Display the setup screen.

- Press **[SETUP]**.

The following setup screen appears.



2 Select "DETAIL" and press **[ENTER]** to confirm.

- Using **[▲/▼]**, select "Closed Caption" and press **[ENTER]** to confirm.



3 Select "DTV CC" and press **[ENTER]** to confirm.

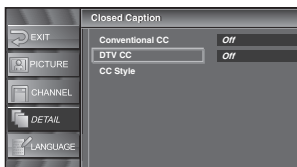

4 Switch the DTV Closed Caption mode.

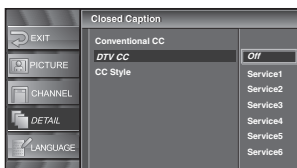

- Using **[▲/▼]**, select the desired DTV Closed Caption, then press **[ENTER]**.

#### Off:

Select if you do not want DTV CC. This is the default.

#### Service 1 to Service 6:

Select one of these before changing any other item in the Closed Caption menu. Choose Service 1 under normal circumstances.

5 To exit the setup, press **[SETUP]**.

## CLOSED CAPTION STYLE

1 Display the setup screen.

- Press **[SETUP]**.

The following setup screen appears.



2 Select "DETAIL" and press **[ENTER]** to confirm.

- Using **[▲/▼]**, select "Closed Caption" and press **[ENTER]** to confirm.

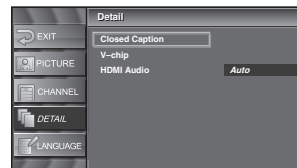

3 Select "CC Style" and press **[ENTER]** to confirm.

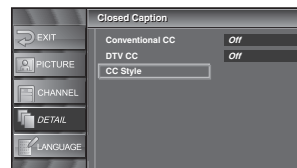

4 Switch the Closed Caption Style.

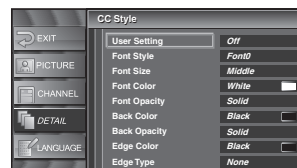

- Using **[▲/▼]**, select the desired Closed Caption Style.

5 Use "User Setting".

- The "User Setting" function lets you change CC style.

- Using **[▲/▼]**, select "User Setting".

- Press **[ENTER]** and set "User Setting" to "On".

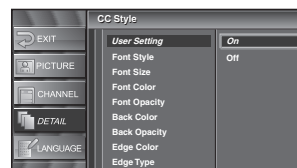

**6** Set each item.

- When “User Setting” is set to “On”, you can set the following items.
- CC style set by “User Setting” will be displayed.
- Using [▲/▼], select the item you want to set.
- You can switch the setting for each item with [▲/▼].

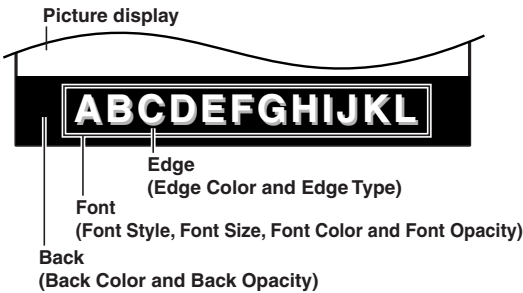

- The setting description for each item is shown below.

**[Font Style]**

Closed Captioning font style can be changed as below.

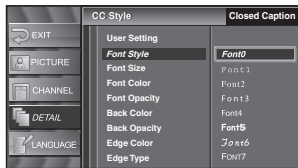

**[Font Size]**

Font size of the displayed caption can be switched as below.

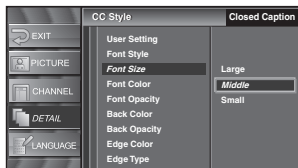

**[Font Color]**

Font color of the displayed caption can be switched as below.

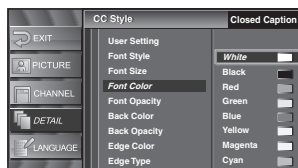

**[Font Opacity]**

Font opacity of the displayed caption can be switched as below.

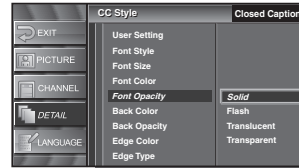

**[Back Color]**

Background color of the displayed caption can be switched as below.

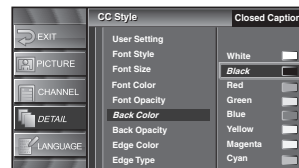

**[Back Opacity]**

Background opacity of the displayed caption can be switched as below.

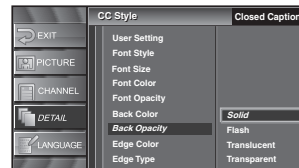

**[Edge Color]**

Edge color of the displayed caption can be switched as below.

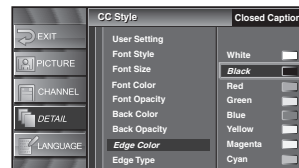

**[Edge Type]**

Edge type of the displayed caption can be switched as below.

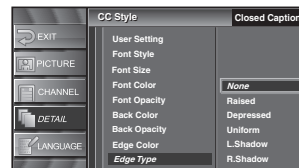

**7** To exit the setup, press [SETUP].

## V-CHIP

You can block certain programming inappropriate for children. This block can be released by entering a password.



### 1 Display the setup screen.

- Press **[SETUP]**.  
The following setup screen appears.



### 2 Select "DETAIL" and press [ENTER].

- Using **[▲/▼]**, select "V-chip".



- Press **[ENTER]**.  
The password entry screen is displayed.



### 3 Enter the password.

- Use **[the Number buttons]** and enter the 4-digit number.



- When you have not set up your password, enter 0000.
- When the password is correct, the following "V-Chip" screen is displayed.

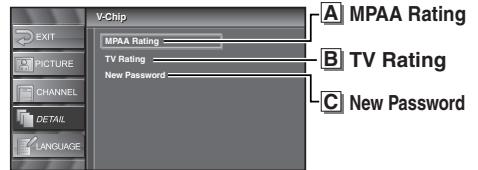

See the following description for setting each item.

### A MPAA Rating

### 4 Display the "MPAA Rating" screen.

- Using **[▲/▼]**, select "MPAA Rating".

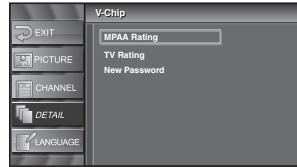

- Press **[ENTER]**.

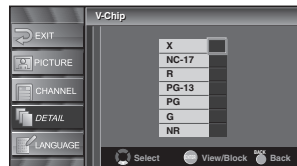

**5** Set “MPAA Rating”.

- Using [▲/▼], select the rating.
- Press [ENTER] and set to “View” or “Block”.

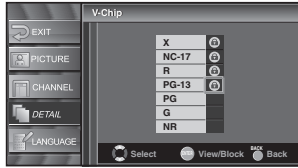

**6** To exit the setup, press [SETUP].

<Selection>	<Rating Category Explanations>
<b>X :</b>	Mature audience only
<b>NC-17 :</b>	No one under 17 admitted
<b>R :</b>	Restricted; under 17 requires accompanying parent or adult guardian
<b>PG-13 :</b>	Unsuitable for children under 13
<b>PG :</b>	Parental Guidance suggested
<b>G :</b>	General Audience
<b>NR :</b>	No Rating

**NOTES:**

- When you select a rating and set it to “Block”, the higher ratings will be blocked automatically. The lower ratings will be available for viewing.
- When you set “X” to “View”, all ratings turn to “View” automatically.

**B** TV Rating

**4** Display the “TV Rating” screen.

- Using [▲/▼], select “TV Rating”.



- Press [ENTER].

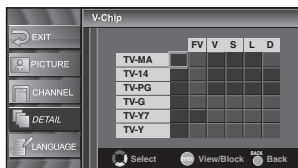

**5** Set “TV Rating”.

- Using [▲/▼], select the rating.
- Press [ENTER] and set to “View” or “Block” for the rating without sub categories.

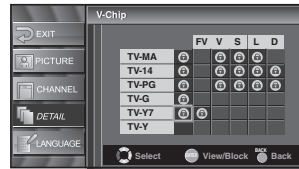

- For the rating with sub categories, press [▲/▼ / ◀ / ▶] and select the rating. Then press [ENTER] and set to “View” or “Block”.

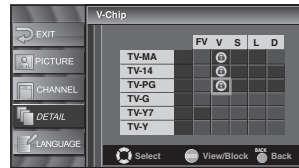

**6** To exit the setup, press [SETUP].

<Selection>	<Rating Category Explanations>
<b>TV-MA :</b>	Mature audience only
<b>TV-14 :</b>	Unsuitable for children under 14
<b>TV-PG :</b>	Parental Guidance suggested
<b>TV-G :</b>	General Audience
<b>TV-Y7 :</b>	Appropriate for children 7 and older
<b>TV-Y :</b>	Appropriate for all children

<Selection>	<Rating Sub Category Explanations>
<b>FV :</b>	Fantasy Violence
<b>V :</b>	Violence
<b>S :</b>	Sexual Situation
<b>L :</b>	Coarse Language
<b>D :</b>	Suggestive Dialogue

**NOTES:**

- When you select a rating and set it to “Block”, the higher ratings will be blocked automatically. The lower ratings will be available for viewing.
- When you set “TV-MA” to “View”, all ratings turn to “View” automatically.

---

## C New Password

---

4 Display the “New Password” screen.

- Using [**▲▼**], select “New Password”.



- Press [**ENTER**].
- 

5 Change the password.

- Use [**the Number buttons**] on the remote control and enter the NEW 4-digit password.
- Enter password again in “Confirm password” space.

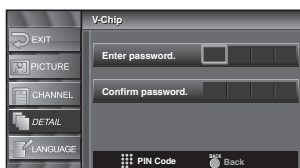

6 To exit the setup, press [**SETUP**].

### NOTES:

- Make sure to enter the exact same new password as the “Confirm password.”. If they are different, the space is cleared for reentering.
- Your password will be erased and return to the default (0000) when a power failure occurs or when you turn off the power using a wall switch. If you forget the password, unplug the power cord for 10 seconds to restore the password to 0000.

## HDMI AUDIO

Set the method of sound input for HDMI jack.

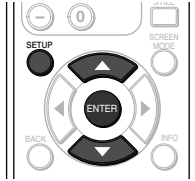

### 1 Display the setup screen.

- Press **[SETUP]**.  
The following setup screen appears.



### 2 Select "DETAIL" and press **[ENTER]** to confirm.

- Using **[▲/▼]**, select "HDMI Audio" and press **[ENTER]** to confirm.

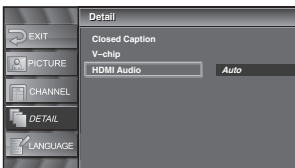

### 3 Switch the HDMI Audio.

- Using **[▲/▼]**, select the desired HDMI Audio, then press **[ENTER]**.

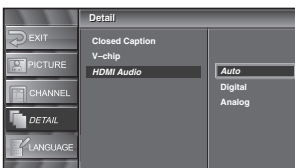

- Select "Auto" if you connected to both digital device with HDMI jack and analog device for audio sources. Digital audio input signal has priority in this setting.
- Select "Digital" if you connected to digital device with HDMI jack for digital audio input signal.
- Select "Analog" if you connected to analog device with analog jacks for analog audio input signal.

### 4 To exit the setup, press **[SETUP]**.

## TROUBLESHOOTING GUIDE

Before calling for service, please refer to the following information.

Symptom	Remedy
No power	<ul style="list-style-type: none"> <li>• Be sure the power cord is connected to outlet.</li> <li>• If a power failure occurs, unplug the power cord for 30 minutes to allow the unit to reset itself.</li> </ul>
No picture or sound	<ul style="list-style-type: none"> <li>• Check if the power is on.</li> <li>• Check the outlet connection.</li> <li>• Check the antenna or cable connection to the main unit.</li> <li>• When the outside antenna is used, check the wire condition and connection.</li> <li>• View other TV channels. The problem might be limited to the broadcasting station.</li> <li>• Turn off the power and wait for about 1 minute, then turn it on again.</li> </ul>
No color	<ul style="list-style-type: none"> <li>• Check the antenna or cable connection to the main unit.</li> <li>• When the outside antenna is used, check the wire condition and connection.</li> <li>• View other TV channels. The problem might be limited to the broadcasting station.</li> <li>• Adjust the Color in the setup screen.</li> </ul>
Sound OK, picture poor	<ul style="list-style-type: none"> <li>• Check the antenna or cable connection to the main unit.</li> <li>• When the outside antenna is used, check the wire condition and connection.</li> <li>• Electrical interference from nearby appliances may affect picture quality.</li> <li>• Adjust Contrast and Brightness in the setup screen.</li> <li>• View other TV channels. The problem might be limited to the broadcasting station.</li> </ul>
Picture distorted	<ul style="list-style-type: none"> <li>• When the outside antenna is used, check the wire condition and connection.</li> <li>• View other TV channels. The problem might be limited to the broadcasting station.</li> </ul>
Weak picture	<ul style="list-style-type: none"> <li>• Check the antenna or cable connection to the main unit.</li> <li>• When the outside antenna is used, check the wire condition and connection.</li> <li>• Adjust Contrast and Brightness in the setup screen.</li> <li>• View other TV channels. The problem might be limited to the broadcasting station.</li> </ul>
Lines or streaks in picture	<ul style="list-style-type: none"> <li>• When the outside antenna is used, check the wire condition and connection.</li> <li>• Electrical interference from nearby appliances may affect picture quality.</li> <li>• View other TV channels. The problem might be limited to the broadcasting station.</li> </ul>
Picture blurred	<ul style="list-style-type: none"> <li>• When the outside antenna is used, check the wire condition and connection.</li> <li>• View other TV channels. The problem might be limited to the broadcasting station.</li> </ul>
Ghosts in picture	<ul style="list-style-type: none"> <li>• Check the antenna or cable connection to the main unit.</li> <li>• When the outside antenna is used, check the wire condition and connection.</li> <li>• Electrical interference from nearby appliances may affect picture quality.</li> <li>• View other TV channels. The problem might be limited to the broadcasting station.</li> </ul>
Bars on screen	<ul style="list-style-type: none"> <li>• When the outside antenna is used, check the wire condition and connection.</li> <li>• Electrical interference from nearby appliances may affect picture quality.</li> </ul>



Symptom	Remedy
Picture rolls vertically	<ul style="list-style-type: none"> <li>• When the outside antenna is used, check the wire condition and connection.</li> <li>• Electrical interference from nearby appliances may affect picture quality.</li> <li>• View other TV channels. The problem might be limited to the broadcasting station.</li> </ul>
Different color marks on screen	<ul style="list-style-type: none"> <li>• Move your TV away from nearby electric appliances. Turn off the power and wait 30 minutes before turning it back on.</li> <li>• View other TV channels. The problem might be limited to the broadcasting station.</li> </ul>
Poor reception on some channels	<ul style="list-style-type: none"> <li>• Check the antenna or cable connection to the main unit.</li> <li>• When the outside antenna is used, check the wire condition and connection.</li> <li>• Electrical interference from nearby appliances may affect picture quality.</li> <li>• View other TV channels. The problem might be limited to the broadcasting station.</li> </ul>
Picture OK, sound poor	<ul style="list-style-type: none"> <li>• View other TV channels. The problem might be limited to the broadcasting station.</li> </ul>
No reception of digital signals	<ul style="list-style-type: none"> <li>• Make sure Autoscanner has been completed (Refer to "AUTOSCAN" on page 13). Autoscanner must be completed when you set up your TV for the first time or move it to a location where previously unavailable channels are broadcast.</li> <li>• The selected channel may not be broadcasting.</li> <li>• When Autoscanner is interrupted, some channels will not be received. Make sure to complete Autoscanner in the setup screen.</li> </ul>
Channel changes automatically	<ul style="list-style-type: none"> <li>• Many digital channels have alternate channel numbers. TV changes the numbers automatically to the ones signifying the broadcasting stations. These are the numbers used for analog broadcasts.</li> </ul>
Remote Control doesn't work	<ul style="list-style-type: none"> <li>• Check the antenna or cable connection to the main unit.</li> <li>• Check the batteries of the remote control.</li> <li>• Check if there is an obstacle between the sensor and the remote control.</li> <li>• Test the signal output. If OK, there might be remote sensor trouble. (Refer to "IR SIGNAL CHECK" on page 34.)</li> </ul>

## Problems with Closed Caption Feature

Misspelled captions are displayed.	<ul style="list-style-type: none"> <li>• Closed captioning production companies may broadcast programs without correcting the misspelling in a live broadcast.</li> </ul>
Captions are not entirely displayed, or captions are delayed behind the dialogue.	<ul style="list-style-type: none"> <li>• Captions that are delayed a few seconds behind the actual dialogue are common for live broadcasts. Most captioning production companies can display a dialogue to a maximum of 220 words per minute. If a dialogue exceeds that rate, selective editing is used to ensure that the captions remain up-to-date with the current TV screen dialogue.</li> </ul>
Captions are displayed as a white box. No caption is displayed in the Closed Caption-supported program.	<ul style="list-style-type: none"> <li>• Interference from buildings or weather conditions may cause captioning to be incomplete.</li> <li>• Broadcasting station may shorten the program to insert advertisement. The closed caption decoder cannot read the information of the shortened program.</li> </ul>
No caption is displayed when playing the videotape containing captions.	<ul style="list-style-type: none"> <li>• The videotape may be illegally copied, or the caption signal might not have been read during copying.</li> </ul>
Black box is displayed in the screen.	<ul style="list-style-type: none"> <li>• "Text" mode is selected for caption. Select "CC1", "CC2", "CC3", "CC4" or "Off".</li> </ul>

The LCD panel is manufactured to provide many years of useful life. Occasionally a few non active pixels may appear as a fixed point of blue, green or red. This is not to be considered a defect in the LCD screen.

## GLOSSARY

### ATSC

Acronym that stands for Advanced Television Systems Committee and the name of the digital broadcasting standards.

### Aspect ratio

The width of a TV screen relative to its height. Conventional TVs are 4:3 (in other words, the screen is almost square); widescreen models are 16:9 (the screen is almost twice as wide as its height).

### Component video

This is a video signal format that conveys each of three principal colors of light (red, blue and green) through different signal lines. This allows the viewers to experience picture colors as original as it is. There are several signal formats, including Y / Pb / Pr and Y / Cb / Cr.

### Dolby Digital

The system developed by Dolby Laboratories to compress digital sound. It offers stereo sound (2ch) or multi-channel audio.

### HDMI (High-Definition Multimedia Interface)

Interface that supports all uncompressed, digital audio/video formats including set-top box, DVD player or digital television, over a single cable.

### High Definition TV (HDTV)

Ultimate digital format that produces high resolution and high picture quality.

### LPCM

#### (Linear Pulse Code Modulation)

LPCM is a format that can have up to 8 channels of audio. It is mainly used in music production. The format samples and captures analog signals and transforms them into digital signals without compressing the sound data.

### NTSC

Acronym that stands for National Television Systems Committee and the name of the current analog broadcasting standards.

### Password

A stored 4-digit number that allows access to parental control features.

### SAP

#### (Secondary Audio Program)

Second-audio channel delivered separately from main-audio channel. This audio channel is used as an alternate in bilingual broadcasting.

### Standard Definition TV (SDTV)

Standard digital format that is similar to the NTSC picture quality.

### S-Video

Offers higher quality images by delivering each signal, color (c) and luminance (y) independently of each other through separate cables.

## MAINTENANCE

### CABINET CLEANING

- Wipe the front panel and other exterior surfaces of the TV with a soft cloth immersed in lukewarm water and wrung dry.
- Never use a solvent or alcohol. Do not spray insecticide liquid near the TV. Such chemicals may cause damage and discoloration to the exposed surfaces.

### LCD CLEANING

Wipe the LCD of the TV with a soft cloth. Before cleaning the LCD, disconnect the power cord.

### SERVICING

Should your unit become inoperative, do not try to correct the problem yourself. There are no user serviceable parts inside. Turn off the TV, unplug the power cord and call our toll free customer support line found on the cover of this manual to locate an authorized service center.

### IR SIGNAL CHECK

If the remote control isn't working properly, you can use an AM radio or digital camera (including a cellular phone with built-in camera) to see if it is sending out an infrared signal.

#### • With an AM radio:

Tune the AM radio station to a non-broadcasting frequency. Point the remote control towards it, push any button and listen. If the sound from the radio flutters, it is receiving the remote control's infrared signal.

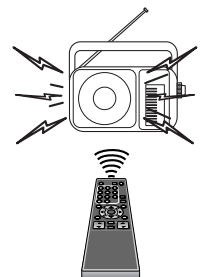

#### • With a digital camera

(including built-in cell phone cameras):

Point a digital camera towards the remote control. Push any button on the remote control and look through the digital camera. If the infrared light appears through the camera, the remote control is working.



# SPECIFICATIONS

## GENERAL SPECIFICATIONS

<b>Television System:</b>	ATSC NTSC-M TV Standard
<b>Closed Caption System:</b>	§15.119/FCC (Analog CC) §15.122/FCC (Digital CC)
<b>Channel Coverage (ATSC/NTSC)</b>	
<b>VHF:</b>	2 ~ 13
<b>UHF:</b>	14 ~ 69
<b>CATV:</b>	2 ~ 13, A ~ W, W+1 ~ W+94, A-5 ~ A-1, 5A
<b>Tuning System:</b>	Channel frequency synthesized tuning system
<b>Channel Access:</b>	Direct access keyboard, Programmable scan, and Up/down
<b>Terminals</b>	
<b>Antenna Input:</b>	VHF/UHF/CATV 75 ohm unbalanced (F-type)
<b>S-Video Input:</b>	Mini DIN 4-pin jack x 2
<b>Video Input:</b>	RCA jack x 2
<b>Audio Input:</b>	RCA jack (L/R) x 4
<b>Component Video/Audio Input:</b>	One pin jack (Y) / 1Vpp x 2 Two pin jacks (Pb/Pr) / 700mVpp x 4 RCA jack (L/R) x 4
<b>HDMI / Audio Input:</b>	HDMI jack RCA jack (L/R) x 2
<b>Coaxial Digital Audio Output:</b>	One pin jack, 500mVpp
<b>Analog Audio Output:</b>	RCA jack (L/R) x 2
<b>Stereo Sound System Speaker</b>	

## ELECTRICAL SPECIFICATION

**Sound Output:** 5W, 8 ohm x 2

## OTHER SPECIFICATIONS

<b>Remote Control:</b>	Digital encoded infrared light system
<b>Operating Temperature:</b>	5°C to 40°C (41°F to 104°F)
<b>Power Requirements:</b>	AC120V, 60Hz
<b>Power Consumption (Maximum):</b>	160W
<b>LCD:</b>	32" wide XGA panel (1,366 x 768 pixels)
<b>Dimensions:</b>	<Without stand> H : 23.5" (595mm) W : 32.3" (818mm) D : 4.6" (115mm) <With stand> H : 25.4" (644mm) W : 32.3" (818mm) D : 10.9" (275mm)
<b>Weight:</b>	30.4 lbs. (13.8kg)

- Designs and specifications are subject to change without notice and without our legal obligation.
- If there is a discrepancy between languages, the default language will be English.



## LIMITED WARRANTY

FUNAI CORP. will repair this product, free of charge in the USA in the event of defect in materials or workmanship as follows:

### DURATION:

**PARTS:** FUNAI CORP. will provide parts to replace defective parts without charge for one (1) year from the date of original retail purchase. Certain parts and LCD image burn-in are excluded from this warranty.

**LABOR:** FUNAI CORP. will provide the labor without charge for a period of ninety (90) days from the date of original retail purchase.

### LIMITS AND EXCLUSIONS:

THIS WARRANTY IS EXTENDED ONLY TO THE ORIGINAL RETAIL PURCHASER. A PURCHASE RECEIPT OR OTHER PROOF OF ORIGINAL RETAIL PURCHASE WILL BE REQUIRED TOGETHER WITH THE PRODUCT TO OBTAIN SERVICE UNDER THIS WARRANTY.

This warranty shall not be extended to any other person or transferee.

This warranty is void and of no effect if any serial numbers on the product are altered, replaced, defaced, missing or if service was attempted by an unauthorized service center. This limited warranty does not apply to any product not purchased and used in the United States.

This warranty only covers failures due to defects in material or workmanship which occurs during normal use. It does not cover damage which occurs in shipment, or failures which are caused by repairs, alterations or product not supplied by FUNAI CORP., or damage which results from accident, misuse, abuse, mishandling, misapplication, alteration, faulty installation, improper maintenance, commercial use such as hotel, rental or office use of this product or damage which results from fire, flood, lightning or other acts of God.

THIS WARRANTY DOES NOT COVER PACKING MATERIALS, ANY ACCESSORIES (EXCEPT REMOTE CONTROL), ANY COSMETIC PARTS, COMPLETE ASSEMBLY PARTS, DEMO OR FLOOR MODELS.

FUNAI CORP. AND ITS REPRESENTATIVES OR AGENTS SHALL IN NO EVENT BE LIABLE FOR ANY GENERAL, INDIRECT OR CONSEQUENTIAL DAMAGES ARISING OUT OF OR OCCASIONED BY THE USE OF OR THE INABILITY TO USE THIS PRODUCT. THIS WARRANTY IS MADE IN LIEU OF ALL OTHER WARRANTIES, EXPRESS OR IMPLIED, AND OF ALL OTHER LIABILITIES ON THE PART OF FUNAI, ALL OTHER WARRANTIES INCLUDING THE WARRANTY OF MERCHANTABILITY AND FITNESS FOR A PARTICULAR PURPOSE, ARE HEREBY DISCLAIMED BY FUNAI AND ITS REPRESENTATIVES IN THE UNITED STATES.

ALL WARRANTY INSPECTIONS AND REPAIRS MUST BE PERFORMED BY AN AUTHORIZED SERVICE CENTER. THIS WARRANTY IS ONLY VALID WHEN THE UNIT IS CARRIED-IN TO AN AUTHORIZED SERVICE CENTER.

THE PRODUCT MUST BE ACCOMPANIED BY A COPY OF THE ORIGINAL RETAIL PURCHASE RECEIPT. IF NO PROOF OF PURCHASE IS ATTACHED, THE WARRANTY WILL NOT BE HONORED AND REPAIRS COSTS WILL BE CHARGED.

### IMPORTANT:

THIS LIMITED WARRANTY GIVES YOU SPECIFIC LEGAL RIGHTS. YOU MAY HAVE OTHER RIGHTS THAT VARY FROM STATE TO STATE. IF, AT ANY TIME DURING THE WARRANTY PERIOD, YOU ARE UNABLE TO OBTAIN SATISFACTION WITH THE REPAIR OF THIS PRODUCT, PLEASE CONTACT FUNAI CORP.

### ATTENTION:

FUNAI CORP. RESERVES THE RIGHT TO MODIFY ANY DESIGN OF THIS PRODUCT WITHOUT PRIOR NOTICE.

### WARRANTY STATEMENT REGARDING NON AUTHORIZED REPAIRS:

To obtain warranty service, you must take the product, or deliver the product freight prepaid, in either its original packaging or packaging affording an equal degree of protection, to any AUTHORIZED SERVICE CENTER. FUNAI CORP. will not reimburse you for any service done by unauthorized service providers without prior written approval.

To locate your nearest AUTHORIZED SERVICE CENTER or for general service inquiries, please contact us at :

FUNAI CORPORATION  
Customer Service

Tel :1-800-256-2487

<http://www.EmersonAudioVideo.com>

19900 Van Ness Avenue, Torrance, CA 90501