

Owner's Manual

G2016wa

ENVISION™
S O M E T H I N G T O S E E

LCD Monitor

TABLE OF CONTENTS

FOR YOUR SAFETY -----	1
SAFETY PRECAUTIONS -----	2
SPECIAL NOTES ON LCD MONITORS -----	3
BEFORE YOU OPERATE THE MONITOR -----	3
FEATURES -----	3
PACKING LIST -----	3
INSTALLATION INSTRUCTIONS -----	4
CONTROLS AND CONNECTORS -----	5
ADJUSTING THE VIEWING ANGLE -----	6
OPERATING INSTRUCTIONS -----	7
GENERAL INSTRUCTIONS -----	7
HOW TO ADJUST A SETTING -----	9
ADJUSTING THE PICTURE -----	10-11
PLUG AND PLAY -----	12
TECHNICAL SUPPORT(FAQ) -----	13
ERROR MESSAGE & POSSIBLE SOLUTION -----	14
APPENDIX -----	15
SPECIFICATIONS -----	15-16
FACTORY PRESET TIMING TABLE -----	17
CONNECTOR PIN ASSIGNMENT -----	18-19

Before operating the monitor, please read this manual thoroughly. This manual should be retained for future reference.

FCC Class B Radio Frequency Interference Statement

WARNING: (FOR FCC CERTIFIED MODELS)

NOTE: This equipment has been tested and found to comply with the limits for a Class B digital device, pursuant to Part 15 of the FCC Rules. These limits are designed to provide reasonable protection against harmful interference in a residential installation. This equipment generates, uses and can radiate radio frequency energy, and if not installed and used in accordance with the instructions, may cause harmful interference to radio communications. However, there is no guarantee that interference will not occur in a particular installation. If this equipment does cause harmful interference to radio or television reception, which can be determined by turning the equipment off and on, the user is encouraged to try to correct the interference by one or more of the following measures:

1. Reorient or relocate the receiving antenna.
2. Increase the separation between the equipment and receiver.
3. Connect the equipment into an outlet on a circuit different from that to which the receiver is connected.
4. Consult the dealer or an experienced radio/TV technician for help.

NOTICE:

1. The changes or modifications not expressly approved by the party responsible for compliance could void the user's authority to operate the equipment.
2. Shielded interface cables and AC power cord, if any, must be used in order to comply with the emission limits.
3. The manufacturer is not responsible for any radio or TV interference caused by unauthorized modification to this equipment. It is the responsibilities of the user to correct such interference.

As an ENERGY STAR® Partner our company has determined that this product meets the ENERGY STAR® guidelines for energy efficiency.

WARNING:

To prevent fire or shock hazard, do not expose the monitor to rain or moisture. Dangerously high voltages are present inside the monitor. Do not open the cabinet. Refer servicing to qualified personnel only.

PRECAUTIONS

- Do not use the monitor near water, e.g. near a bathtub, washbowl, kitchen sink, laundry tub, swimming pool or in a wet basement.
- Do not place the monitor on an unstable cart, stand, or table. If the monitor falls, it can injure a person and cause serious damage to the appliance. Use only a cart or stand recommended by the manufacturer or sold with the monitor. If you mount the monitor on a wall or shelf, use a mounting kit approved by the manufacturer and follow the kit instructions.
- Slots and openings in the back and bottom of the cabinet are provided for ventilation. To ensure reliable operation of the monitor and to protect it from overheating, be sure these openings are not blocked or covered. Do not place the monitor on a bed, sofa, rug, or similar surface. Do not place the monitor near or over a radiator or heat register. Do not place the monitor in a bookcase or cabinet unless proper ventilation is provided.
- The monitor should be operated only from the type of power source indicated on the label. If you are not sure of the type of power supplied to your home, consult your dealer or local power company.
- The monitor is equipped with a three-pronged grounded plug, a plug with a third (grounding) pin. This plug will fit only into a grounded power outlet as a safety feature. If your outlet does not accommodate the three-wire plug, have an electrician install the correct outlet, or use an adapter to ground the appliance safely. Do not defeat the safety purpose of the grounded plug.
- Unplug the unit during a lightning storm or when it will not be used for long period of time. This will protect the monitor from damage due to power surges.
- Do not overload power strips and extension cords. Overloading can result in fire or electric shock.
- Never push any object into the slot on the monitor cabinet. It could short circuit parts causing a fire or electric shock. Never spill liquids on the monitor.
- Do not attempt to service the monitor by yourself; opening or removing covers can expose you to dangerous voltages and other hazards. Please refer all servicing to qualified service personnel.
- To ensure satisfactory operation, use the monitor only with UL listed computers which have appropriate configured receptacles marked between 100 - 240V AC, Min. 5A.
- The wall socket shall be installed near the equipment and shall be easily accessible.

SPECIAL NOTES ON LCD MONITORS

The following symptoms are normal with LCD monitor and do not indicate a problem.

NOTES

- Due to the nature of the fluorescent light, the screen may flicker during initial use. Turn off the Power Switch and then turn it on again to make sure the flicker disappears.
- You may find slightly uneven brightness on the screen depending on the desktop pattern you use.
- The LCD screen has effective pixels of 99.99% or more. It may include blemishes of 0.01% or less such as a missing pixel or a pixel lit all of the time.
- Due to the nature of the LCD screen, an afterimage of the previous screen may remain after switching the image when the same image has been displayed for a long time. The monitor will slowly recover from this.

BEFORE YOU OPERATE THE MONITOR

FEATURES

- 20" Widescreen TFT Color LCD Monitor
- Certified for Windows Vista
- Recommended Resolutions: 1680 X1050@60Hz
- EPA ENERGY STAR®
- RGB Analog & DVI-D with HDCP Input
- Built-in Stereo Speakers

CHECKING THE CONTENTS OF THE PACKAGE

The product package should include the following items:

1. LCD Monitor
2. Owner's Manual
3. Power Cord
4. D-Sub Cable
5. Audio Cable
6. DVI Cable

INSTALLATION INSTRUCTIONS

SWIVEL BASE

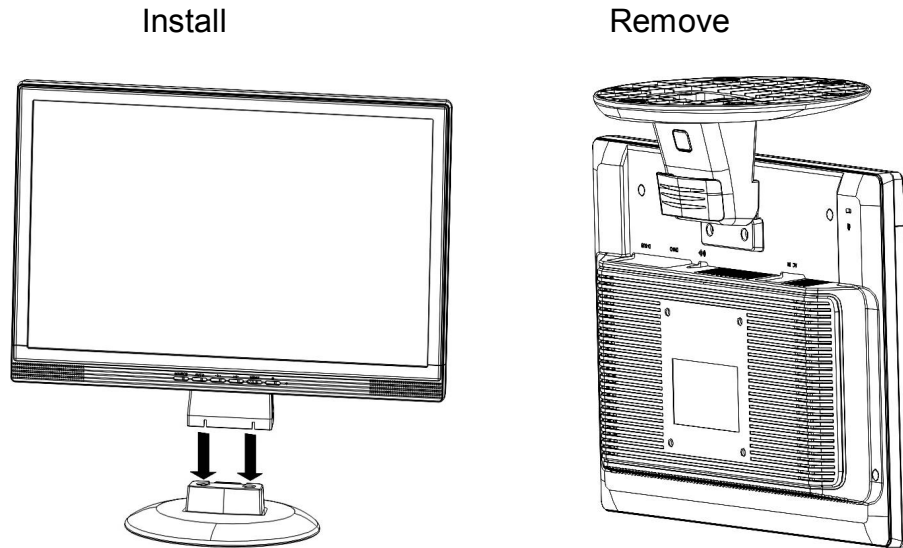

Figure 1 Installing and Removing the Base

POWER CORD

Power Source:

1. Make sure that the power cord is the correct type required in your area.
2. This LCD monitor has an External universal power supply that allows operation in either 100/120V AC or 220/240V AC voltage area (No user adjustment is required.)
3. Connect the power cord into your LCD monitor's power input socket, and then plug the other end into a 3-pin AC power outlet. The power cord may be connected to either a wall power outlet or the power outlet socket on your PC, depending on the type of power cord supplied with your LCD monitor.

NOTES

A certified power supply cord has to be used with this equipment. The relevant national installation and/or equipment regulations shall be considered. A certified power supply cord not lighter than ordinary polyvinyl chloride flexible cord according to IEC 60227 (designation H05VV-F 3G 0.75mm² or H05VVH2-F2 3G 0.75mm²) shall be used. Alternative a flexible cord be of synthetic rubber according to IEC 60245 (designation H05RR-F 3G 0.75mm²) shall be used.

CONTROLS AND CONNECTORS

CONNECTING CABLES

Connecting the D-Sub Cable: Connect one end of the 15-pin D-Sub cable to the D-sub Signal input socket on back of the monitor and connect the other end to the computer's D-Sub port.

Connecting the Power Cord: Connect the power cord into your LCD monitor's power input socket, and then plug the other end into a 3-pin AC power outlet.

Caution: If the AC outlet is not grounded (with three holes), install the proper grounding adapter (not supplied).

Connecting the DVI Cable (optional) : Connect one end of the 24-pin DVI cable to the DVI signal input socket on the back of the monitor and connect the other end to the computer's DVI port.

Connecting the Audio Cable: Plug audio cable between the computer multi-media (or sound) card's audio output and monitor's audio input socket.

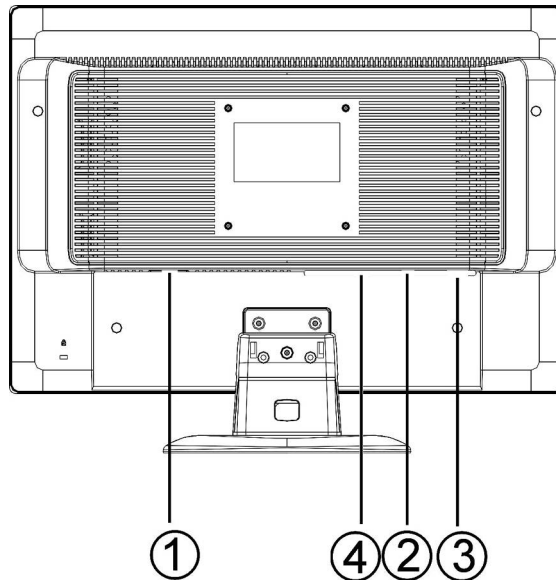

Figure 2 Connecting Cables

1.	Power input socket
2.	DVI Signal input socket
3.	D-Sub Signal input socket
4.	Audio input socket

ADJUSTING THE VIEWING ANGLE

- For optimal viewing it is recommended to look at the full face of the monitor, then adjust the monitor's angle to your own preference.
- Hold the stand so you do not topple the monitor when you change the monitor's angle.
- You are able to adjust the monitor's angle from -5° to 20° .

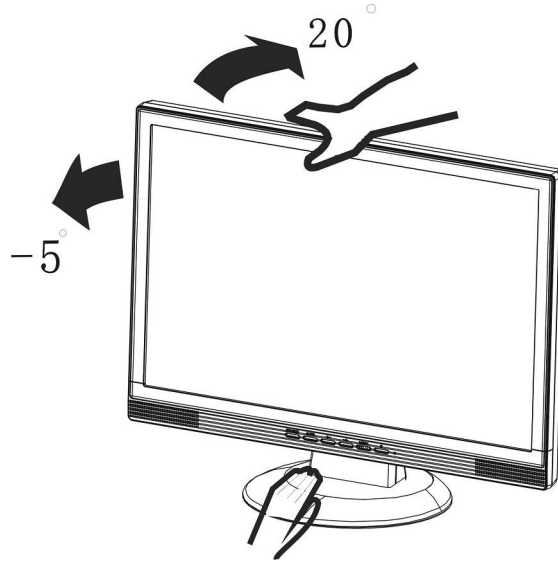

Figure 3

NOTES

- Do not touch the LCD screen when you change the angle. It may cause damage or break the LCD screen.
- Careful attention is required not to catch your fingers or hands when you change the angle.

OPERATING INSTRUCTIONS

GENERAL INSTRUCTIONS

Press the power button to turn the monitor on or off. The other control buttons are located on the front panel of the monitor (See Figure 4). By changing these settings, the picture can be adjusted to your personal preferences.

- Connect the cables according to instructions above (section Connecting Cables)
- Press the power button to turn on the monitor. The power indicator will light up.

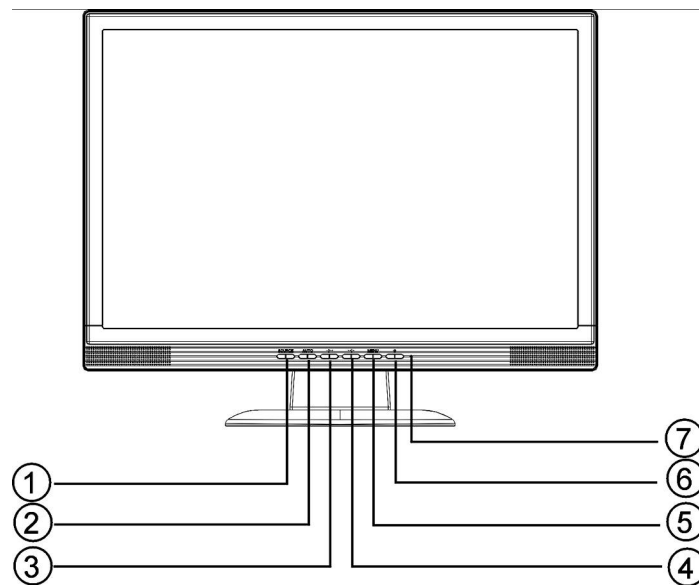

Figure 4 External Control Button

EXTERNAL CONTROLS

1.	Source
2.	Auto Adjust button / Exit
3.	< / Volume
4.	> /Volume
5.	MENU / ENTER
6.	Power Button
7.	LED

FRONT PANEL CONTROL

- **Power Button / Power Indicator:**
Press this button to turn the monitor ON or OFF.
Green — Power On mode.
Orange — Off mode.
- **MENU / ENTER :**
Activate OSD menu when OSD is OFF or activate/de-activate adjustment function when OSD is ON or Exit OSD menu when in Volume Adjust OSD status.
- **> /Volume:**
Activates the volume control when the OSD is OFF or navigate through adjustment icons when OSD is ON or adjust a function when function is activated.
- **< /Volume:**
Activates the volume control when the OSD is OFF or navigate through adjustment icons when OSD is ON or adjust a function when function is activated.
- **Auto Adjust button / Exit:**
 1. When OSD menu is in active status, this button will act as EXIT-KEY (EXIT OSD menu).
 2. When OSD menu is in off status, press this button for 2 seconds to activate the Auto Adjustment function.
The Auto Adjustment function is used to set the HPos, VPos, Clock and Focus.

OSD Lock Function: To lock the OSD, press and hold the MENU button while the monitor is off and then press power button to turn the monitor on. To un-lock the OSD - press and hold the MENU button while the monitor is off and then press power button to turn the monitor on.

NOTES

- Do not install the monitor in a location near heat sources such as radiators or air ducts, or in a place subject to direct sunlight, or excessive dust or mechanical vibration or shock.
- Save the original shipping carton and packing materials, as they will come in handy if you ever have to ship your monitor.
- For maximum protection, repackage your monitor as it was originally packed at the factory.
- To maintain the cleanness of your LCD display, wipe it periodically with clean and soft cloth. The screen may be damaged by any liquid splash.
- To keep the monitor looking new, periodically clean it with a soft cloth. Stubborn stains may be removed with a cloth lightly dampened with a mild detergent solution. Never use strong solvents such as thinner, benzene, or abrasive cleaners, since these will damage the cabinet. As a safety precaution, always unplug the monitor before cleaning it.

HOW TO ADJUST A SETTING



1. Press the **MENU**-button to activate the OSD window.
2. Press < or > to navigate through the functions. Once the desired function is highlighted, press the MENU-button to activate it. If the function selected has a sub-menu, press **MENU** button again to navigate through the sub-menu functions. Once the desired function is highlighted, press **MENU** button to activate it.
3. Press < or > to change the settings of the selected function.
4. To exit and save, allow the OSD menu to time out automatically or press the **AUTO/EXIT** button until the OSD menu goes off. If you want to adjust any other function, repeat the above steps.







Figure 5 The OSD Message

ADJUSTING THE PICTURE

The descriptions for function control LEDs

Main Menu Item	Main Menu Icon	Sub Menu Item	Sub Menu	Description	
Luminance		Brightness		Backlight Adjustment	
		Contrast		Contrast from Digital-register	
		Eco	Standard		Standard Mode
			Text		Text Mode
			Internet		Internet Mode
			Game		Game Mode
			Movie		Movie Mode
			Sports		Sports Mode
		Gamma	Gamma1		Adjust to Gamma 1
			Gamma2		Adjust to Gamma 2
			Gamma3		Adjust to Gamma 3
		DCR	Off		Disable dynamic contrast ratio
			On		Enable dynamic contrast ratio
Image Setup		Clock		Adjust picture Clock to reduce Vertical-Line noise	
		Focus		Adjust Picture Phase to reduce Horizontal-Line noise	
		H.Position		Adjust the horizontal position of the picture	
		V.Position		Adjust the vertical position of the picture	
		Warm		Recall Warm Color Temperature from EEPROM	
Color Temp.		Normal		Recall Normal Color Temperature from EEPROM	
		Cool		Recall Cool Color Temperature from EEPROM	
		sRGB		Recall SRGB Color Temperature from EEPROM	
		User	User-B		Blue Gain from Digital-register
			User-G		Green Gain Digital-register
			User-R		Red Gain from Digital-register
			User-Y		Yellow Gain from Digital-register
User-C		Cyan Gain from Digital-register			

Main Menu Item	Main Menu Icon	Sub Menu Item	Sub Menu	Description
			User-M	Magenta Gain from Digital-register
Color Boost		Full Enhance	on or off	Disable or Enable Full Enhance Mode
		Nature Skin	on or off	Disable or Enable Nature Skin Mode
		Green Field	on or off	Disable or Enable Green Field Mode
		Sky-blue	on or off	Disable or Enable Sky-blue Mode
		AutoDetect	on or off	Disable or Enable AutoDetect Mode
		Demo	on or off	Disable or Enable Demo
Picture Boost		Frame Size		Adjust Frame Size
		Brightness		Adjust Frame Brightness
		Contrast		Adjust Frame Contrast
		Hue		Adjust Frame Hue
		Saturation		Adjust Frame Saturation
		Position		Adjust Frame Position
		Bright Frame	on or off	Disable or Enable Bright Frame
OSD Setup		H.Position		Adjust the horizontal position of OSD
		V.Position		Adjust the vertical position of OSD
		Timeout		Adjust the OSD Timeout
		Language		Select the OSD language
Extra		Input Select	Digital	Select Digital Signal Source as Input
			Analog	Select Analog Signal Source as Input
		Auto Config		Auto adjust the picture to default
		DDC/CI		Turn ON/OFF DDC/CI Support
		Reset	yes or no	Reset the menu to default
		Information		Show the information of the main image and sub-image source

PLUG AND PLAY

Plug & Play DDC2B Feature

This monitor is equipped with VESA DDC2B capabilities according to the VESA DDC STANDARD. It allows the monitor to inform the host system of its identity and, depending on the level of DDC used, communicate additional information about its display capabilities.

The DDC2B is a bidirectional data channel based on the I²C protocol. The host can request EDID information over the DDC2B channel.

THIS MONITOR WILL APPEAR TO BE NON-FUNCTIONAL IF THERE IS NO VIDEO INPUT SIGNAL. IN ORDER FOR THIS MONITOR TO OPERATE PROPERLY, THERE MUST BE A VIDEO INPUT SIGNAL.

This monitor meets the Green monitor standards as set by the Video Electronics Standards Association (VESA) and/or the United States Environmental Protection Agency (EPA) and The Swedish Confederation Employees (NUTEK). This feature is designed to conserve electrical energy by reducing power consumption when there is no video-input signal present. When there is no video input signal this monitor, following a time-out period, will automatically switch to an OFF mode. This reduces the monitor's internal power supply consumption. After the video input signal is restored, full power is restored and the display is automatically redrawn. The appearance is similar to a "Screen Saver" feature except the display is completely off. The display is restored by pressing a key on the keyboard, or clicking the mouse.

TECHNICAL SUPPORT (FAQ)

Problem & Question	Possible Solution
Power LED is not on	*Check if the Power Switch is in the ON position *Power Cord should be connected
No Plug & Play	*Check if the PC system is Plug & Play compatible *Check if the Video Card is Plug & Play compatible *Check if the D-15 plug pin of Video Cable is bent
Picture is fuzzy	*Adjust the Contrast and Brightness Controls.
Picture bounces or a wave pattern is present in the picture	*Move electrical devices that may cause electrical interference.
The power LED is ON but there's no video or no picture.	*Computer Power Switch should be in the ON position. *Computer Video Card should be snugly seated in its slot. *Make sure monitor's video cable is properly connected to the computer. *Inspect monitor's video cable and make sure none of the pins are bent. *Make sure computer is operational by hitting the CAPS LOCK key on the keyboard while observing the CAPS LOCK LED. The LED should either turn ON or OFF after hitting the CAPS LOCK key.
Missing one of the primary colors (RED, GREEN, or BLUE)	*Inspect the monitor's video cable and make sure that none of the pins are bent.
Screen image is not centered or sized properly.	*Adjust pixel frequency (CLOCK) and FOCUS or press hot-key (AUTO).
Picture has color defects (white does not look white)	*Adjust RGB color or select color temperature.

CLOCK (pixel frequency) controls the number of pixels scanned by one horizontal sweep. If the frequency is not correct, the screen shows vertical stripes and the picture will not have the correct width.

FOCUS adjusts the phase of the pixel clock signal. With a wrong phase adjustment the picture will have horizontal disturbances in light picture.

For FOCUS and CLOCK adjustment use "dot-pattern".

ERROR MESSAGE & POSSIBLE SOLUTION

CABLE NOT CONNECTED :

1. Check that the signal-cable is properly connected , If the connector is loose, tighten the connector's screws.
2. Check the signal-cable's connection pins for damage.

MODE NOT SUPPORTED :

Your computer has been set to unsuitable display mode ,set the computer to display mode given in the following table (See page 17).

APPENDIX

SPECIFICATIONS

LCD Panel	Driving system	TFT Color LCD
	Size	20" Widescreen
	Pixel pitch	0.258mm(H) × 0.258mm(V)
Input	Video	R,G,B Analog Interface
	Separate Sync.	H/V TTL
	H-Frequency	30kHz – 83kHz
	V-Frequency	55-75Hz
Display Colors		16.7M Colors
Dot Clock		146.25MHz
Max. Resolution		1680 x 1050@60Hz
Plug & Play		VESA DDC2B™
EPA ENERGY STAR®	ON Mode	≤49W
	OFF Mode	≤1W
Input Connector		15-pin D-Sub
Input Video Signal		Analog:0.7Vp-p(standard), 75 OHM, Positive
		DVI-D Digital signal
Maximum Screen Size		Horizontal : 433.44mm Vertical : 270.9mm
Power Source		100~240VAC, ,47~63Hz
Environmental Considerations		Operating Temp: 5° to 40°C Storage Temp.: -20° to 60°C Operating Humidity: 10% to 85%
Dimension		471.5(W)x380.2(H)x210.8(D)mm
Weight (N. W.)		4.9kg

External Controls:	Switch	<ul style="list-style-type: none"> • Auto Adjust Key • < / Volume • > / Volume • Power Button • MENU
	Functions	<ul style="list-style-type: none"> • Luminance • Image Setup • Color Temp. • Color Boost • Picture Boost • OSD Setup • Extra
Power Consumption (Maximum)		49 Watts
Audio Output		Rated Power 1.5 W rms (Per channel)
Regulatory Compliance		FCC, cULus, TCO'03

Preset Display Modes

STANDARD	RESOLUTION	HORIZONTAL FREQUENCY	VERTICAL FREQUENCY
Dos-Mode	640 × 350	31.47kHz	70Hz
Dos-Mode	720 × 400	31.47kHz	70Hz
VGA	640 × 480	31.47kHz	60Hz
	640 × 480	35.00kHz	66.6Hz
	640 × 480	37.50kHz	75Hz
	640 × 480	37.86kHz	72Hz
SVGA	800 × 600	37.879kHz	60Hz
	800 × 600	46.875kHz	75Hz
	800 × 600	35.16kHz	56Hz
	800 × 600	48.01kHz	72Hz
	832 × 624	49.725kHz	75Hz
XGA	1024 × 768	48.363kHz	60Hz
	1024 × 768	56.476kHz	70Hz
	1024 × 768	60.02kHz	75Hz
SXGA	1280 × 1024	64.00kHz	60Hz
	1280 × 1024	80.00kHz	75Hz
WSXGA	1680 × 1050	65.29kHz	60Hz

CONNECTOR PIN ASSIGNMENT

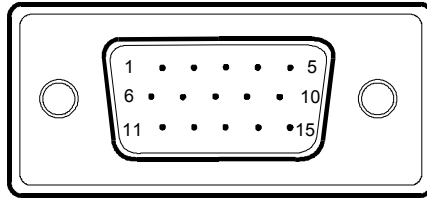

15 - Pin Color Display Signal Cable

PIN NO.	DESCRIPTION	PIN NO.	DESCRIPTION
1.	Red	9.	+5V
2.	Green	10.	Detect Cable
3.	Blue	11.	Ground
4.	Ground	12.	DDC-Serial Data
5.	Ground	13.	H-Sync
6.	R-Ground	14.	V-Sync
7.	G-Ground	15.	DDC-Serial Clock
8.	B-Ground		

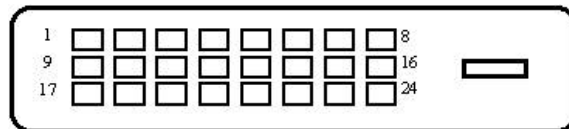

DVI-D 24pin Color Display Signal Cable

Pin	Meaning	Pin	Meaning	Pin	Meaning
1.	TMDS Data2-	9.	TMDS Data1-	17.	TMDS Data0-
2.	TMDS Data2+	10.	TMDS Data1+	18.	TMDS Data0+
3.	TMDS Data 2/4 Shield	11.	TMDS Data 1/3 Shield	19.	TMDS Data 0/5 Shield
4.	not connected	12.	not connected	20.	not connected
5.	not connected	13.	not connected	21.	not connected
6.	DDC Clock	14.	+5V Power	22.	DDC Clock Shield
7.	DDC Data	15.	Ground	23.	DDC Clock+
8.	Analogue Vertical Sync	16.	Hot Plug Detect	24.	DDC Clock-