

COBY®

TF-TV705

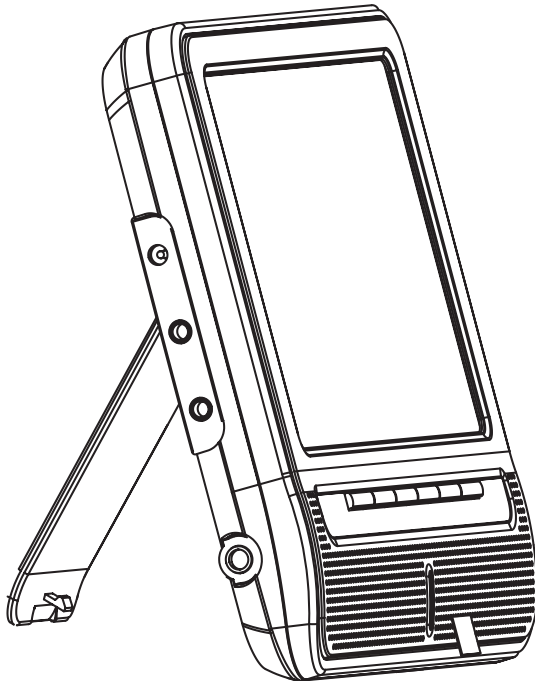

**7" WIDESCREEN TFT LCD
PORTABLE FLATSCREEN TELEVISION**



Instruction Manual

Please read this manual carefully before operation.

PRECAUTIONS

	CAUTION WARNING: SHOCK HAZARD. DO NOT OPEN. AVIS: RISQUE DE CHOC ELECTRIQUE. NE PAS OUVRIR	
CAUTION: TO REDUCE THE RISK OF FIRE AND ELECTRIC SHOCK, DO NOT REMOVE THE COVER (OR BACK) OF THE UNIT. REFER SERVICING ONLY TO QUALIFIED SERVICE PERSONNEL.		

For Customer Use:

Enter below the serial number that is located on the bottom of the unit. Retain this information for future reference.

Model No. _____ TF-TV705 _____

Serial No. _____



The lightning flash with arrowhead symbol within an equilateral triangle is intended to alert the user to the presence of uninsulated "dangerous voltage" within the product's enclosure that may be of sufficient magnitude to constitute a risk of electric shock.



The exclamation point within an equilateral triangle is intended to alert the user to the presence of important operation and servicing instructions in the literature accompanying the appliance.

WARNING:

To prevent fire or shock hazard, do not expose this device to rain or moisture. Dangerous high voltage is present inside the enclosure. Do not open the cabinet.

WARNING:

Handling the cords on this product will expose you to lead, a chemical known to the State of California to cause cancer, and birth defects or other reproductive harm. **Wash hands after handling.**

FCC Notice:

This equipment has been tested and found to comply with the limits for a Class B digital device pursuant with the FCC Rules, Part 15. These limits are designed to provide reasonable protection against harmful interference in a residential installation. This equipment generates, uses, and can radiate radio frequency energy, and if not installed and used in accordance with the instructions may cause harmful interference to radio communication.

CAUTION:

To prevent electric shock, match wide blade of plug to wide slot of outlet and fully insert.

NOTE:

Before plugging the power cord into an AC outlet, make sure that all the connections have been made.



For recycling or disposal information about this product, please contact your local authorities or the Electronics Industries Alliance: www.eiae.org.

IMPORTANT SAFETY INSTRUCTIONS

1. **Read Instructions:** All the safety and operating instructions should be read before the product is operated.
2. **Retain Instructions:** The safety and operating instructions should be retained for future reference.
3. **Heed Warnings:** All warnings on the product and in the operating instructions should be adhered to.
4. **Follow Instructions:** All operating and usage instructions should be followed.
5. **Cleaning:** Unplug this product from the wall outlet before cleaning. Do not use liquid cleaners or aerosol cleaners. Use a damp cloth for cleaning.
6. **Attachments:** Use only attachments recommended by the manufacturer. Use of other attachments may be hazardous.
7. **Water and Moisture:** Do not use this product near water (e.g., near a bath tub, washbowl, kitchen sink, laundry tub, in wet basements, or near a swimming pool and the like).
8. **Accessories:** Do not place this product on an unstable cart, stand, tripod, bracket, or table. Use only with carts, stands, tripods, brackets, or tables recommended by the manufacturer or sold with the product. Any mounting of the product should follow the manufacturer's instructions and should use a mounting accessory recommended by the manufacturer.
9. A product and cart combination should be moved with care. Quick stops, excessive force, and uneven surfaces may cause the product and cart combination to overturn.
10. **Ventilation:** Slots and openings in the cabinet are provided for ventilation to ensure reliable operation of the product and to protect it from overheating. These openings should never be blocked by placing the product on a bed, sofa, rug, or other similar surface. This product should not be placed in a built-in installation such as a bookcase or rack unless proper ventilation is provided or the manufacturer instructions have been adhered to.
11. **Power Sources:** This product should be operated only from the type of power source indicated on the rating label. If you are not sure of the type of power supply to your home, consult your product dealer or local power company. For products intended to operate from battery power or other sources, refer to the operating instructions.
12. **Grounding or Polarization:** This product may be equipped with a polarized alternating-current line plug that has one blade wider than the other. This plug will only fit into the power outlet in one direction. This is a safety feature. If you are unable to insert the plug fully into the outlet, try reversing the direction of the plug. If the plug should still fail to fit, contact an electrician to replace the obsolete outlet. Do not defeat the safety purpose of the polarized plug.
13. **Power-Cord Protection:** Power supply cords should be routed so that they are not likely to be walked on or pinched by items placed upon or against them, paying particular attention to cords at plugs, convenience receptacles, and at the point which they exit from the product.
14. **Protective Attachment Plug:** The product may be equipped with an attachment plug with overload protection. This is a safety feature. See the operating instructions for replacement or directions to reset the protective device. If replacement of the plug is required, be sure the service technician has used a replacement plug that has the same overload protection as the original plug as specified by the manufacturer.



IMPORTANT SAFETY INSTRUCTIONS

- Outdoor Antenna Grounding: If an outside antenna is connected to the product, be sure the antenna system is grounded so as to provide some protection against voltage surges and built-up static charges. Article 810 of the National Electrical Code, ANS/NFPA 70 provides information with regard to proper grounding of the mast and supporting structure, grounding of the lead-in wire to an antenna-discharge unit, size of grounding conductors, location of antenna-discharge unit, connection to grounding electrodes, and requirements for the grounding electrode (see figure).

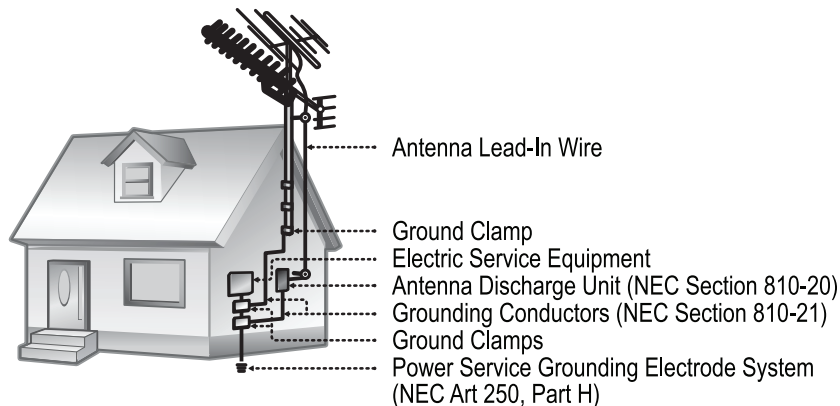

- Lightning: For added protection for this product, unplug it from the wall outlet and disconnect the antenna or cable system during a lightning storm or when it is left unattended and unused for long periods of time. This will prevent damage to the product due to lightning or power-line surges.
- Power Lines: An outside antenna system should not be located in the vicinity of overhead power lines or other electric light or power circuits, or where it can fall into such power lines or circuits. When installing an outside antenna system, extreme care should be taken to keep from touching such power lines or circuits, as contact with them might be fatal.
- Overloading: Do not overload wall outlets, extension cords, or integral convenience receptacles as this can result in a risk of fire or electric shock.
- Object and Liquid Entry: Never push objects of any kind into this product through openings as they may touch dangerous voltage points or shout-out parts that could result in a fire or electric shock. Never spill liquid of any kind on the product.
- Servicing: Do not attempt to service this product yourself as opening or removing covers may expose you to dangerous voltage or other hazards. Refer all servicing to qualified service personnel.
- Damage Requiring Service: Unplug this product from the wall outlet and refer servicing to qualified service personnel under the following conditions: a) when the power-supply or plug is damaged; b) if liquid has been spilled or if objects have fallen into the product; c) if the product has been exposed to rain or water; d) if the product does not operate normally by following the operating instructions. Adjust only those controls that are covered by the operating instructions as improper adjustment of other controls may result in damage and will often require extensive work by a qualified technician to restore the product to its normal operation; e) if the product has been dropped or damaged in any way; f) when the product exhibits a distinct change in performance—this indicates a need for service.

IMPORTANT SAFETY INSTRUCTIONS

22. **Replacement Parts:** When replacement parts are required, be sure that your service technician has used replacement parts specified by the manufacturer or have the same characteristics as the original part. Unauthorized substitutions may result in fire, electric shock, or other hazards.
23. **Safety Check:** Upon completion of any service or repairs to this product, ask the service technician to perform safety checks to ensure that the product is in proper operating condition.
24. **Wall or Ceiling Mounting:** The product should be mounted to a wall or ceiling only as recommended by the manufacturer.
25. **Heat:** The product should be situated away from heat sources such as radiators, heat registers, stoves, or other products (including amplifiers) that produce heat.

TABLE OF CONTENTS

PRECAUTIONS	2
IMPORTANT SAFETY INSTRUCTIONS	3
TABLE OF CONTENTS	6
FEATURES	7
PACKAGE CONTENTS	8
LOCATION OF CONTROLS	9
Left Panel View	9
Front Panel View	9
Right Panel View	9
Rear Panel View	9
Remote Control	10
GETTING STARTED	11
Powering your Device	11
AC Power Operation	11
Battery Operation	11
Power Management	11
Using the Remote Control	12
Cable Connections	13
Coaxial External Antenna Input (optional)	13
Audio/Video (AV) Input (optional)	13
TV FUNCTION	14
Basic Operation	14
TV Setup Menu	14
Menu Navigation	14
Menu Options	14
AV FUNCTION	15
Basic Operation	15
AV Setup Menu	15
Menu Navigation	15
Menu Options	15
TROUBLESHOOTING	16
SPECIFICATIONS	17

FEATURES

- 7" Widescreen TFT LCD Color Display
- LED Backlight Technology provides a brighter display and increased battery life
- High-Sensitivity NTSC TV with Digital Tuning
- Integrated Telescopic Antenna
- Coaxial Antenna Input for use with External Antenna Sources
- AV Input for use with Video Games, VCRs, or other AV Sources
- Headphone Jack for Private Listening
- High-Output Stereo Speakers
- Integrated Viewing Stand
- Rechargeable Lithium-Ion Battery
- Three-Way Power: AC/DC/Battery Operation
- Full Function Remote Control

PACKAGE CONTENTS

Please make sure the following items are included with your LCD TV/monitor. If any items are missing, contact your local dealer.

1. TF-TV705
2. Remote Control
3. AC Power Cord
4. AV Cable
5. Coaxial (RF) Antenna Adapter

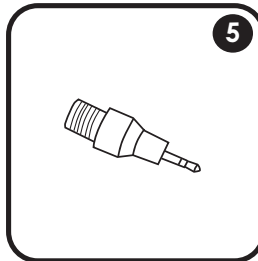
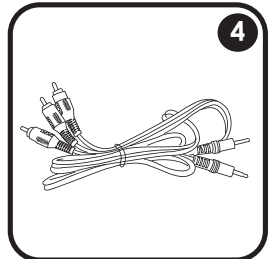
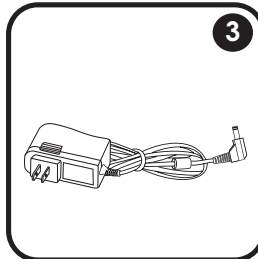
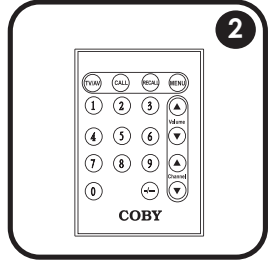

LOCATION OF CONTROLS

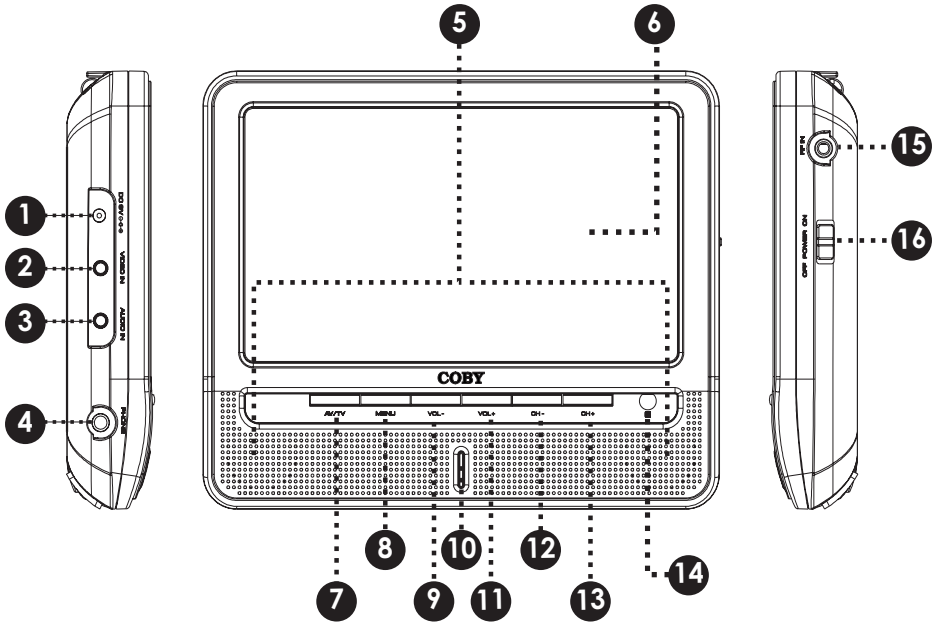

Left Panel View

1. DC Power In
2. Video In
3. Audio In
4. Headphone Out

Front Panel View

5. Stereo Speakers
6. TFT LCD Display
7. AV/TV Mode
8. Menu
9. Volume Down
10. Power Indicator
11. Volume Up
12. Channel Down
13. Channel Up
14. Remote Sensor

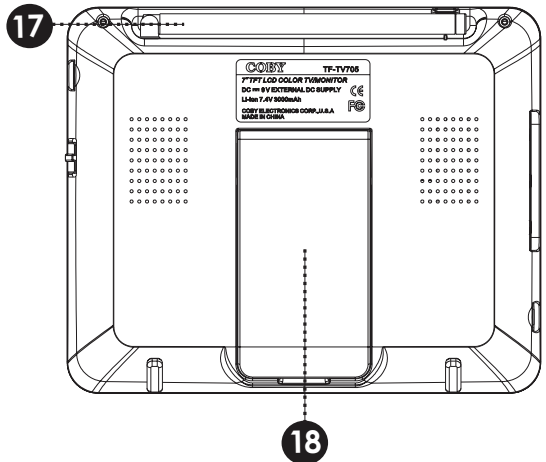

Right Panel View

15. Coaxial (RF) Antenna In
16. Power Switch (On/Off)

Rear Panel View

17. Telescopic Antenna
18. Kickstand

LOCATION OF CONTROLS

Remote Control

1. TV/AV
TV or AV Mode Select
2. Call
View the current channel number
3. Recall
Return to the previous channel
4. Menu
Access the Setup Menu
5. Volume Up / Volume Down
Adjust the volume level
6. Channel Up / Channel Down
Change the channel up or down
7. Numeric Keypad
Enter numeric input data.
8. Input
Use with the Numeric Keypad to change the channel directly.

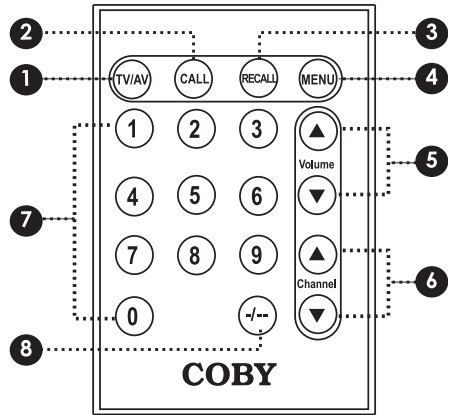

GETTING STARTED

Powering your Device

AC Power Operation

Your device should be connected to an AC 100-240V wall outlet.

- Using the supplied power adapter, plug one end of the adapter into the Power In jack of your device and plug the other end into an AC 100-240V wall outlet.

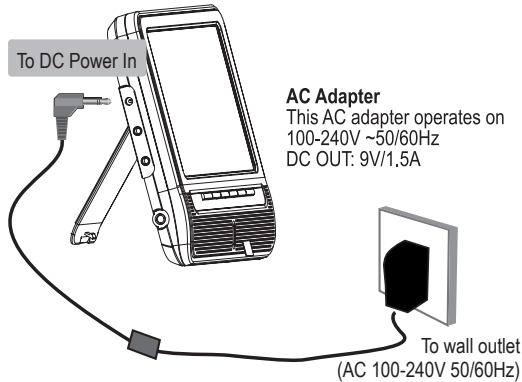

Do not connect the power plug to a power outlet other than that which is indicated here or on the label as this may result in the risk of fire or electric shock.

Do not handle the power plug with wet hands. Doing so may cause electric shock.

Use only AC adapters of the type specified here. Failure to do so may cause a fire or damage the player.

Battery Operation

Your player can operate on a built-in 7.2V rechargeable battery.

- To charge the battery, simply connect the AC adapter as directed above. The Power Indicator will light red when the battery is being charged; it will light green when the battery is fully charged.



The battery should be charged fully before it is used for the first time.

Power Management

If the player will not be in use for a long period of time, set the Power Switch to the OFF position, remove the battery, and unplug the player.

GETTING STARTED

Using the Remote Control

To load a battery in the remote:

1. Press in the direction of the arrow
2. Slide the compartment out
3. Place the battery in the compartment with the positive side (+) facing up
4. Push the compartment in to close

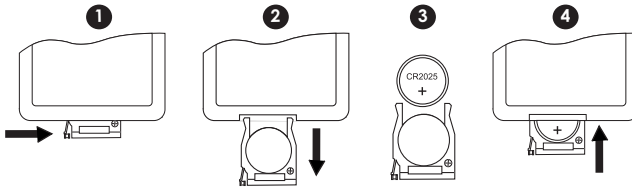

The battery used in this device may present a fire or chemical hazard if mistreated. Do not recharge, disassemble, incinerate, or heat the batteries.

Used batteries should be disposed of safely and not incinerated. Attention should be shown to the environment aspects of battery disposal.

Keep batteries out of the reach of children.

To use the remote:

- Point the remote at the remote sensor of the photo frame at a distance of no more than 15' and at an angle no greater than 60 degrees.



Batteries will last for about one year under typical usage. Replace the batteries if the remote is no longer working.

Do not spill water on the remote control.

Do not use the remote control for other equipment at the same time.

Remove the batteries if the remote control will not be in use for an extended period of time.

GETTING STARTED

Cable Connections

You can use an AV cable to connect an external device for display on the TF-TV705.

Do not connect the power until all connections have been made.

Coaxial External Antenna Input (optional)

Use a Coaxial (RF) Antenna Adapter to connect an external antenna source for use with the TF-TV705 instead of the built-in telescopic antenna.

TV RF sources may include: Over-the-Air receiving antennas or cable lines. You can use a 75 ohm coaxial cable to connect an outdoor antenna.

1. Attach an external antenna (RF, Cable) to the Coaxial (RF) Antenna Adapter.
2. Plug the adapter into the Coaxial (RF) Antenna In jack of the unit.
3. Set the unit to TV mode.

Audio/Video (AV) Input (optional)

Use a Audio/Video (AV) cable to connect an external AV source for use with the TF-TV705.

External AV sources may include: DVD players, VCRs, camcorders, or game consoles.

1. Plug the AV cable's **black** 3.5mm jack into the Audio In jack of the TF-TV705.
2. Plug the AV cable's **yellow** 3.5mm jack into the Video In jack of the TF-TV705.
3. Connect the AV cable's red and white RCA jacks to the audio output of the external device.
4. Connect the AV cable's yellow RCA jack to the video output of the external device.
5. Set the unit to AV mode.

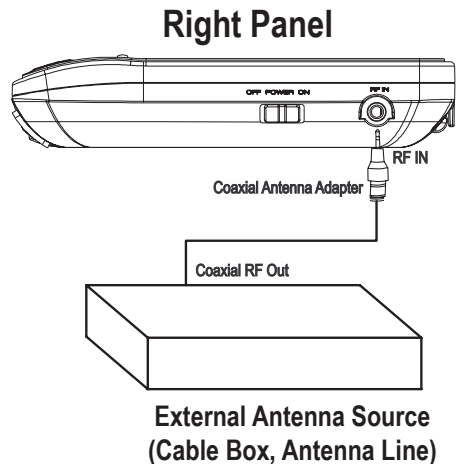
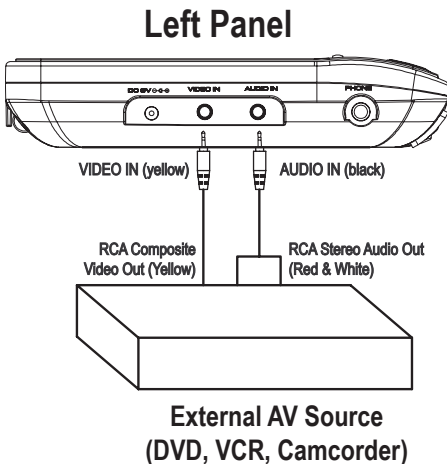

TV FUNCTION

Basic Operation

1. Prepare the antenna (optional) and power connections (see the Getting Started section for details)
2. To turn the TV on, set the Power Switch to the “On” position.
3. To set the unit to TV mode, press AV/TV. You should see the antenna signal on screen.
4. To change the channel, press CH+/CH-.
5. To change the channel directly, press INPUT on the remote, then use the numeric keypad to enter a channel number.
6. To view the current channel number on screen, press CALL. To return to a previously viewed channel, press RECALL.
7. To adjust the volume level, press VOL+/VOL-.

TV Setup Menu

Menu Navigation

To navigate the TV menu:

- Press MENU. The Setup menu will appear on screen.
- To select an option, press CH+/CH-.
- To adjust a selected option, press VOL+/VOL-.
- To exit the Setup menu, press MENU.

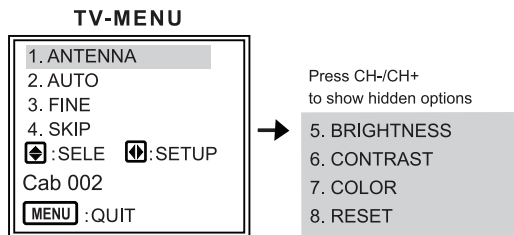

Menu Options

The TV setup menu contains the following options: ANTENNA, AUTO, FINE, SKIP, BRIGHTNESS, CONTRAST, COLOR, RESET.

Item	Description
Antenna	Set the Antenna system type: HRC, IRC, Air, Cable.
Auto	Select to search and store all available broadcast channels.
Fine	Adjust to fine-tune reception of a channel
Skip	Set to “On” skip an unwanted channel; set to “Off” to keep the channel
Brightness	Adjust the brightness level of the display screen.
Contrast	Adjust the contrast level of the display screen.
Color	Adjust the color level of the display screen.
Reset	Restore all options to their factory-default settings

AV FUNCTION

Basic Operation

1. Prepare the AV Input and power connections (see the Getting Started section for details).
2. To turn the TV on, set the Power Switch to the "On" position
3. To set the unit to AV mode, press AV/TV. You should see the AV Input signal on screen
4. To adjust the volume level, press VOL+/VOL-

AV Setup Menu

Menu Navigation

To navigate the AV setup menu:

- Press MENU. The AV Setup menu will appear on screen.
- To select an option, press CH+/CH-.
- To adjust a selected option, press VOL+/VOL-.
- To exit the Setup menu, press MENU.

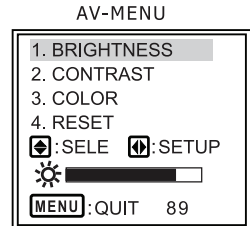

Menu Options

The TV setup menu contains the following options: BRIGHTNESS, CONTRAST, COLOR, RESET.

Item	Description
Brightness	Adjust the brightness level of the display screen.
Contrast	Adjust the contrast level of the display screen.
Color	Adjust the color level of the display screen.
Reset	Restore all options to their factory-default settings

TROUBLESHOOTING

If you have a problem with this TV, please read the troubleshooting guide below and check our website at www.cobyusa.com for Frequently Asked Questions (FAQs) and firmware updates. If these resources do not resolve the problem, please contact Technical Support.

COBY Electronics Technical Support

56-65 Rust Street
Maspeth, NY 11378

Hours: Monday to Friday, 8:30 AM–11:00 PM EST
Saturday to Sunday, 9:00 AM–11:00 PM EST

Email: techsupport@cobyusa.com

Phone: 800-681-2629 or 718-416-3197

Web: www.cobyusa.com

There is no power to the device.

- Ensure that the Power Switch is physically set to the ON position.
- Ensure that the AC adapter cord is securely connected to the TV and the proper wall outlet.

There is no picture.

- Ensure that the TV set has been powered on and is set to the correct mode (TV or AV).
- Ensure that the connections between the player and the TV are secure and correct.
- Check if the connection cables are damaged.

The picture is noisy or distorted.

- Ensure that the video source is compatible with your TV (NTSC or PAL).
- If an antenna is in use, try repositioning it for better reception.
- Ensure that the AV cable is securely connected.

There is no sound or distorted sound.

- Ensure that the TV and/or AV device have been turned on and properly set up.
- Ensure that the TV and/or AV connections are secure and correct.
- If an antenna is in use, try repositioning it for better reception.

The remote control doesn't work.

- Ensure that there are no obstacles between the remote and the player.
- Point the remote at the remote sensor on the main unit.
- Ensure that the batteries in the remote retain a charge and have been installed correctly.
- Try replacing the remote's batteries.

The unit has malfunctioned.

- Unplug the TV and let it rest for 30 minutes, then reconnect the power. The restore function should reset the TV.

SPECIFICATIONS

Display Type	7" Widescreen TFT LCD with LED Backlight
Display Resolution	480 x 234
TV System	NTSC
TV Tuning system	Full Over-The-Air Channels VHF-L: 55.25MHZ ~ 127.25 MHZ VHF-H: 133.25 MHZ ~ 361.25 MHZ UHF: 367.25 ~ 801.25 MHZ
Power Supply	AC: 100-240V 50/60Hz DC: 9V, 1.5A
Power Consumption	Working: 15W (max)
Input	Component Video Stereo Audio Coaxial Antenna (RF)
Output	3.5mm Headphone
Operating Temperature	50°F - 104°F
Unit Dimensions	6.50" x 5.20" x 2.56" (WHD)
Weight	0.91 lbs

Specifications and manual are subject to change without prior notice.

NOTES

NOTES

COBY Electronics Corp.

56-65 Rust Street
Maspeth, NY 11378

www.cobyusa.com
www.ecoby.com