

COBY®

TF-DVD1971

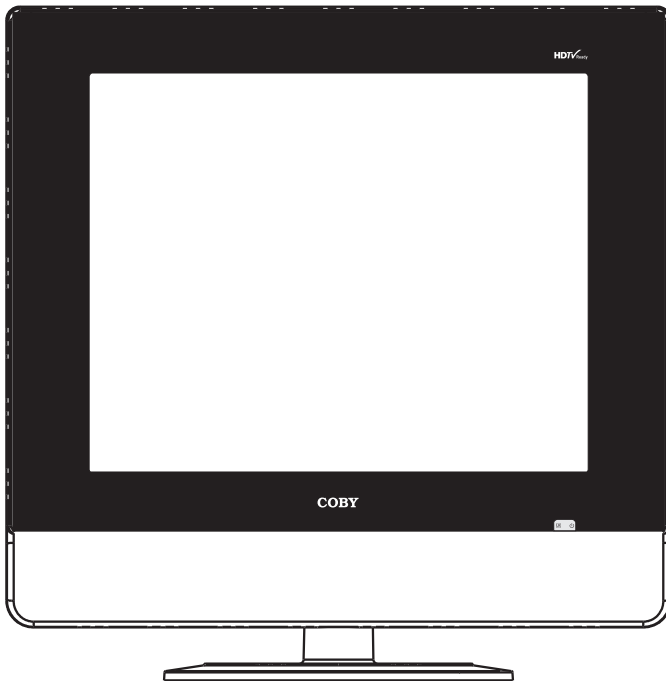

**19" TFT LCD FLATSCREEN TELEVISION with
SLOT-LOADING DVD PLAYER**



Instruction Manual

Please read this manual carefully before operation.

PRECAUTIONS

	CAUTION WARNING: SHOCK HAZARD. DO NOT OPEN. AVIS: RISQUE DE CHOC ELECTRIQUE. NE PAS OUVRIR	
CAUTION: TO REDUCE THE RISK OF FIRE AND ELECTRIC SHOCK, DO NOT REMOVE THE COVER (OR BACK) OF THE UNIT. REFER SERVICING ONLY TO QUALIFIED SERVICE PERSONNEL.		

For Customer Use:

Enter below the serial number that is located on the bottom of the unit. Retain this information for future reference.

Model No. TF-DVD1971

Serial No. _____



The lightning flash with arrowhead symbol within an equilateral triangle is intended to alert the user to the presence of uninsulated "dangerous voltage" within the product's enclosure that may be of sufficient magnitude to constitute a risk of electric shock.



The exclamation point within an equilateral triangle is intended to alert the user to the presence of important operation and servicing instructions in the literature accompanying the appliance.

WARNING:

To prevent fire or shock hazard, do not expose this device to rain or moisture. Dangerous high voltage is present inside the enclosure. Do not open the cabinet.

FCC Notice:

This equipment has been tested and found to comply with the limits for a Class B digital device pursuant with the FCC Rules, Part 15. These limits are designed to provide reasonable protection against harmful interference in a residential installation. This equipment generates, uses, and can radiate radio frequency energy, and if not installed and used in accordance with the instructions may cause harmful interference to radio communication.

CAUTION:

To prevent electric shock, match wide blade of plug to wide slot of outlet and fully insert.

NOTE:

Before plugging the power cord into an AC outlet, make sure that all the connections have been made.

Copyright Protection:

Unauthorized copying, broadcasting, public performance, and lending of disks are prohibited. This product incorporates copyright protection technology that is protected by method claims of certain U.S. patents and other intellectual property rights owned by Macrovision Corporation and other rights owners. Use of this copyright protection technology must be authorized by Macrovision Corporation, and is intended for home and other limited viewing uses only unless otherwise authorized by Macrovision Corporation. Reverse engineering or disassembly is prohibited.

NOTE:

The LCD panel used in this television contains millions of thin film transistors that have been manufactured using a high-technology process to deliver a crisp, clear, and detailed picture. Occasionally, a few of these transistors may become stuck or non-active; please note that this does not affect the performance of the television.



For recycling or disposal information about this product, please contact your local authorities or the Electronics Industries Alliance: www.eiae.org.

For information regarding disposal and recycling in the state of California, please visit the eRecycle website at: www.eRecycle.org.

SAFETY INSTRUCTIONS

1. **Read Instructions:** All the safety and operating instructions should be read before the product is operated.
2. **Retain Instructions:** The safety and operating instructions should be retained for future reference.
3. **Heed Warnings:** All warnings on the product and in the operating instructions should be adhered to.
4. **Follow Instructions:** All operating and usage instructions should be followed.
5. **Cleaning:** Unplug this product from the wall outlet before cleaning. Do not use liquid cleaners or aerosol cleaners. Use a damp cloth for cleaning.
6. **Attachments:** Use only attachments recommended by the manufacturer. Use of other attachments may be hazardous.
7. **Water and Moisture:** Do not use this product near water (e.g., near a bath tub, washbowl, kitchen sink, laundry tub, in wet basements, or near a swimming pool and the like).
8. **Accessories:** Do not place this product on an unstable cart, stand, tripod, bracket, or table. Use only with carts, stands, tripods, brackets, or tables recommended by the manufacturer or sold with the product. Any mounting of the product should follow the manufacturer's instructions and should use a mounting accessory recommended by the manufacturer.
9. A product and cart combination should be moved with care. Quick stops, excessive force, and uneven surfaces may cause the product and cart combination to overturn.
10. **Ventilation:** Slots and openings in the cabinet are provided for ventilation to ensure reliable operation of the product and to protect it from overheating. These openings should never be blocked by placing the product on a bed, sofa, rug, or other similar surface. This product should not be placed in a built-in installation such as a bookcase or rack unless proper ventilation is provided or the manufacturer instructions have been adhered to.
11. **Power Sources:** This product should be operated only from the type of power source indicated on the rating label. If you are not sure of the type of power supply to your home, consult your product dealer or local power company. For products intended to operate from battery power or other sources, refer to the operating instructions.
12. **Grounding or Polarization:** This product may be equipped with a polarized alternating-current line plug that has one blade wider than the other. This plug will only fit into the power outlet in one direction. This is a safety feature. If you are unable to insert the plug fully into the outlet, try reversing the direction of the plug. If the plug should still fail to fit, contact an electrician to replace the obsolete outlet. Do not defeat the safety purpose of the polarized plug.
13. **Power-Cord Protection:** Power supply cords should be routed so that they are not likely to be walked on or pinched by items placed upon or against them, paying particular attention to cords at plugs, convenience receptacles, and at the point which they exit from the product.
14. **Protective Attachment Plug:** The product may be equipped with an attachment plug with overload protection. This is a safety feature. See the operating instructions for replacement or directions to reset the protective device. If replacement of the plug is required, be sure the service technician has used a replacement plug that has the same overload protection as the original plug as specified by the manufacturer.



SAFETY INSTRUCTIONS

- Outdoor Antenna Grounding: If an outside antenna is connected to the product, be sure the antenna system is grounded so as to provide some protection against voltage surges and built-up static charges. Article 810 of the National Electrical Code, ANS/NFPA 70 provides information with regard to proper grounding of the mast and supporting structure, grounding of the lead-in wire to an antenna-discharge unit, size of grounding conductors, location of antenna-discharge unit, connection to grounding electrodes, and requirements for the grounding electrode (see figure).

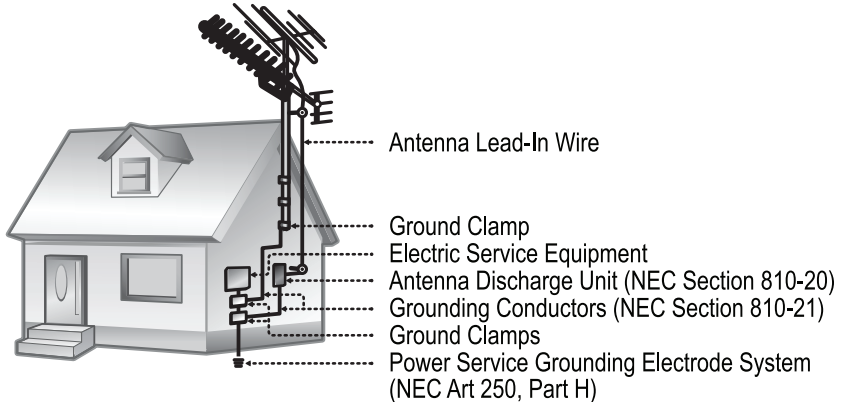

- Lightning: For added protection for this product, unplug it from the wall outlet and disconnect the antenna or cable system during a lightning storm or when it is left unattended and unused for long periods of time. This will prevent damage to the product due to lightning or power-line surges.
- Power Lines: An outside antenna system should not be located in the vicinity of overhead power lines or other electric light or power circuits, or where it can fall into such power lines or circuits. When installing an outside antenna system, extreme care should be taken to keep from touching such power lines or circuits, as contact with them might be fatal.
- Overloading: Do not overload wall outlets, extension cords, or integral convenience receptacles as this can result in a risk of fire or electric shock.
- Object and Liquid Entry: Never push objects of any kind into this product through openings as they may touch dangerous voltage points or shout-out parts that could result in a fire or electric shock. Never spill liquid of any kind on the product.
- Servicing: Do not attempt to service this product yourself as opening or removing covers may expose you to dangerous voltage or other hazards. Refer all servicing to qualified service personnel.
- Damage Requiring Service: Unplug this product from the wall outlet and refer servicing to qualified service personnel under the following conditions: a) when the power-supply or plug is damaged; b) if liquid has been spilled or if objects have fallen into the product; c) if the product has been exposed to rain or water; d) if the product does not operate normally by following the operating instructions. Adjust only those controls that are covered by the operating instructions as improper adjustment of other controls may result in damage and will often require extensive work by a qualified technician to restore the product to its normal operation; e) if the product has been dropped or damaged in any way; f) when the product exhibits a distinct change in performance—this indicates a need for service.

SAFETY INSTRUCTIONS

22. **Replacement Parts:** When replacement parts are required, be sure that your service technician has used replacement parts specified by the manufacturer or have the same characteristics as the original part. Unauthorized substitutions may result in fire, electric shock, or other hazards.
23. **Safety Check:** Upon completion of any service or repairs to this product, ask the service technician to perform safety checks to ensure that the product is in proper operating condition.
24. **Wall or Ceiling Mounting:** The product should be mounted to a wall or ceiling only as recommended by the manufacturer.
25. **Heat:** The product should be situated away from heat sources such as radiators, heat registers, stoves, or other products (including amplifiers) that produce heat.

TABLE OF CONTENTS

PRECAUTIONS.....	2
SAFETY INSTRUCTIONS.....	3
TABLE OF CONTENTS.....	6
FEATURES.....	8
ABOUT OPTICAL DISCS.....	9
Disc Requirements.....	9
Disc Care and Maintenance.....	9
Handling a Disc.....	9
Cleaning a Disc.....	9
PACKAGE CONTENTS.....	10
LOCATION OF CONTROLS.....	11
Front View.....	11
Right Panel View.....	11
Rear Panel View.....	12
Remote Control.....	13
GETTING STARTED.....	14
Cable Connections.....	14
Coaxial Digital Connection.....	15
Remote Control.....	15
Power Management.....	15
TV FUNCTION.....	16
Basic Operation.....	16
LCD Setup (TV).....	16
Menu Navigation.....	16
Picture Setup.....	17
Sound Setup.....	17
Channel Setup.....	18
Display Setup.....	18
Parental Control Setup.....	19
TV Rating.....	20
Movie Rating.....	20
Blocked Program Notification.....	20
AV FUNCTION.....	21
Basic Operation.....	21
AV Setup Menu.....	21
Menu Navigation.....	21
Image Position (Y-Cb/Pb-Cr/Pr and DVD Mode Only).....	22
Sound (VIDEO or S-VIDEO Mode Only).....	22

TABLE OF CONTENTS

DVD FUNCTION	23
Basic Operation	23
Play/Pause/Stop	23
Previous/Next (Skip)	23
Reverse/Forward (Scan).....	23
Slow	23
Zoom	24
Repeat Mode	24
A-B Repeat Mode	24
GOTO (Search).....	24
Program	25
DVD Program Mode.....	25
Sound.....	25
DVD Functions.....	26
Menu	26
Audio	26
Subtitle.....	26
Angle	26
CD Playback Functions.....	26
JPEG Playback Functions	26
Normal Playback.....	26
Picture Rotation	27
Zoom	27
DVD Setup Menu	27
System	27
Language	28
Audio.....	28
Video.....	28
TROUBLESHOOTING.....	29
SPECIFICATIONS.....	31

FEATURES

Your TF-DVD1971 integrates a DVD player with an LCD display and an NTSC TV Tuner.

Multiple Modes

- DVD
- TV
- VIDEO (Composite)
- S-VIDEO
- Y Cb/Pb Cr/Pr (Component Video: Accepts 480i, 480p, 576i, 576p, 720i, 720p, and 1080i signals)

High-Resolution

- Utilizes MPEG-2 decoding to achieve over 500 lines of horizontal resolution.
- Advanced Liquid Crystal Display Technology delivers crisp, detailed images.
- Standard 4:3 aspect ratio display.

Superior Sound

- Built-in Dolby Digital decoder outputs high-quality sound effects.
- Stereo Amplifier
- Integrated stereo speakers



Advanced Playing Features

- DVD, DVD±R/RW, CD, CD-R/RW, and JPEG disc compatible.
- Zoom function magnifies the screen picture for your enjoyment.
- Time search function allows you to search discs via time code.
- Multiple angle/language/subtitle feature support.

ABOUT OPTICAL DISCS

Disc Requirements

This DVD player supports playback of the following discs.

Type	Disc Mark	Content Type	Disc Size	Max. Playback Time
DVD-Video Discs		Audio + Video (moving picture)	12 cm	133 min (SS-SL)
				242 min (SS-DL)
				266 min (DS-SL)
				484 min (DS-DL)
Audio Compact Discs (CDs)		Audio	12 cm	74 min
JPEG CDs	--	Still Picture	12 cm	--

This unit can play back CD-R and CD-RW discs that contain audio titles or JPEG picture files. Discs not listed above are not supported by this unit (e.g., PC CD-ROM, CD-Extra, CD-G, CD-I, etc.)

Disc Care and Maintenance

Optical discs (DVDs, CDs) contain high-density compressed data and need proper handling.

Handling a Disc

- Hold a DVD/CD by its edges. Avoid touching the recorded side of the disc. To remove a DVD/CD from its storage case, press down on the center retention mechanism of the case and lift the disc out.
- Do not subject discs to prolonged exposure to direct sunlight, high humidity, or high temperatures.
- Do not bend or press discs.
- To reduce the risk of scratches, always put discs back in their case after use. Store discs vertically in a cabinet.
- Do not place stickers or labels on either side of a disc.

Cleaning a Disc

Use a dry, soft cloth to wipe off any fingerprints and dusts from the playing surface of the disc. Wipe in a straight line radially from the center to the outside edge of the disc. Small dust particles and light stains will not affect playback quality.

- Never use chemicals such as record sprays, anti-static sprays, benzene, or thinners to clean a disc. Doing so will damage the surface of the disc permanently.

PACKAGE CONTENTS

Please make sure the following items are included with your LCD TV/monitor. If any items are missing, contact your local dealer.

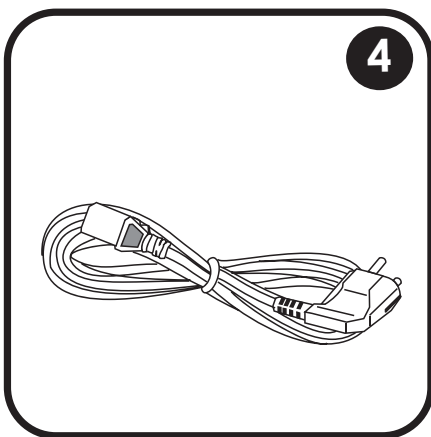
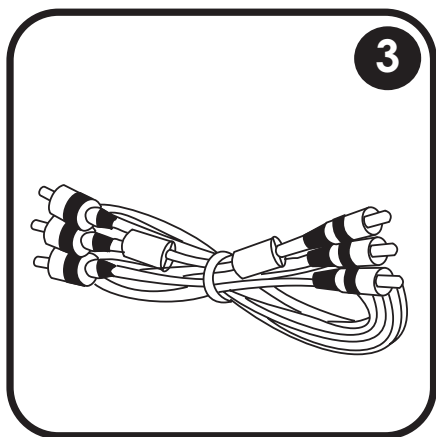
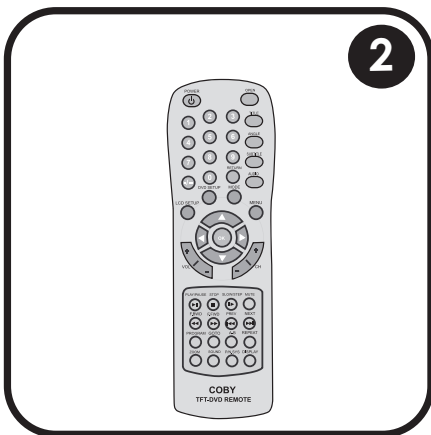
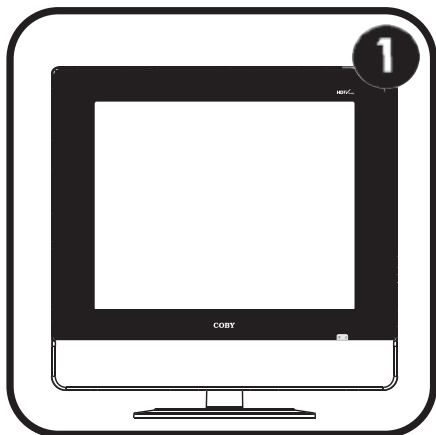

1. TF-DVD1971
2. Remote Control
3. AV Cable
4. AC Power Cord

LOCATION OF CONTROLS

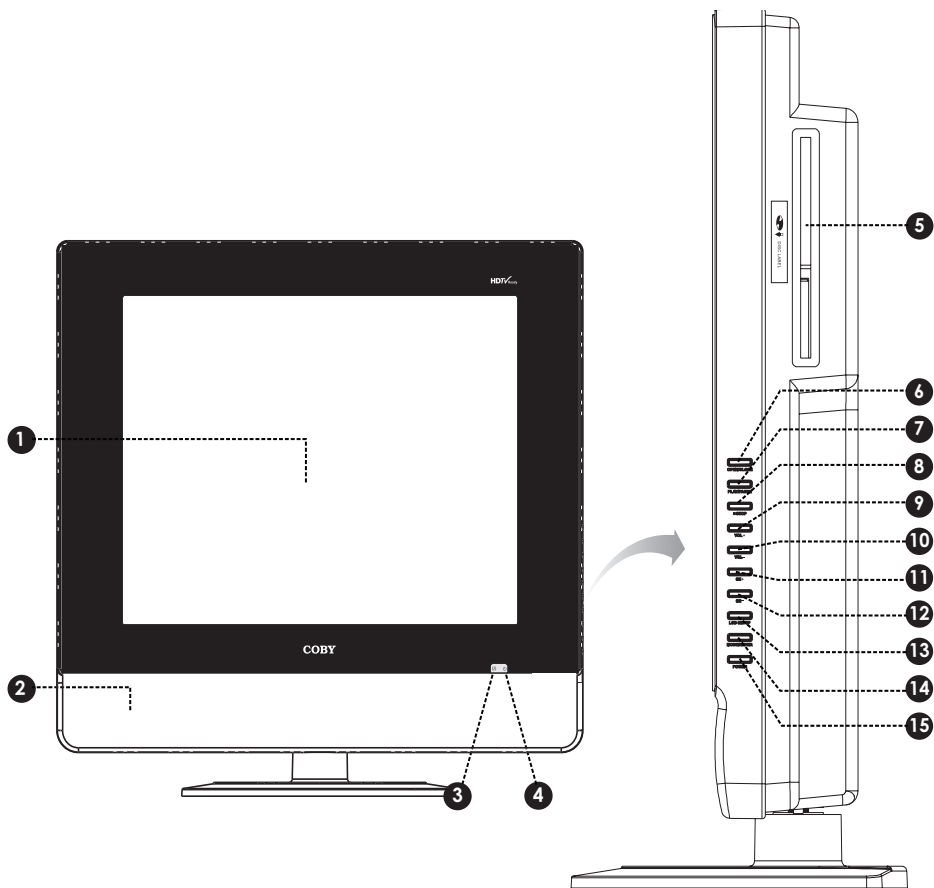

Front View

1. TFT LCD Display
2. Stereo Speakers
3. Remote Sensor
4. Power Indicator

Right Panel View

5. DVD/CD Disc Slot
6. Open/Close Button
7. Play/Pause Button
8. Stop Button
9. Volume Up Button
10. Volume Down Button
11. Channel Up Button
12. Channel Down Button
13. LCD Setup Button
14. Mode/Enter Button
15. Power Button

LOCATION OF CONTROLS

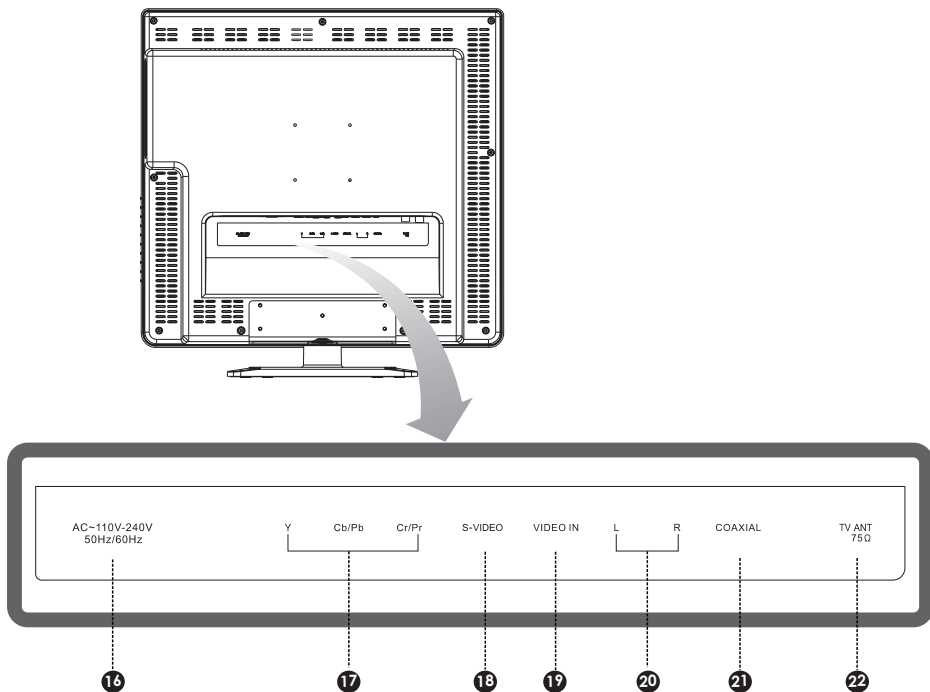

Rear Panel View

- 16. AC 110-240V Power In Jack
- 17. Component Video Input Jacks
- 18. S-Video Input Jack
- 19. Composite Video Input Jack
- 20. RCA Stereo Audio Input Jacks
- 21. Coaxial Digital Audio Output Jack (DVD)
- 22. Coaxial TV Antenna Input Jack

LOCATION OF CONTROLS

Remote Control

1. Power
Turn the TV On/Off
2. Open
Eject the DVD/CD Disc
3. Title
Access the DVD Title Menu
4. Angle
Select a DVD camera angle (if available)
5. Subtitle
Select a DVD subtitle track (if available)
6. Audio
Select a DVD audio track (if available)
7. Menu
Access the DVD Root Menu
8. Mode
Select a TV/DVD Mode (DVD, Composite Video, S-Video, TV, Component Video)
9. DVD Setup (DVD mode)
Access the DVD Setup menu
10. LCD Setup
Access the LCD TV Setup menu
11. Navigation Keypad (Up/Down/Left/Right)
Use the keypad to move the menu selection cursor
12. OK
Confirm a menu selection
13. Numeric Keypad
Input numeric values
14. -/-- (TV Mode)
Enables numeric input mode to use the numeric keypad to enter a channel.
15. Channel + / - (TV Mode)
Adjust the channel up or down.
16. Volume + / -
Adjust the volume level up or down.
17. Play/Pause
18. Stop
19. Reverse (Scan)
20. Forward (Scan)
21. Slow/Step
22. Mute
23. Previous (Skip)
24. Next (Skip)
25. Program
26. Zoom
27. GOTO
28. A-B (Repeat)
29. Repeat
30. Display
31. Sound
Select the Sound output mode.
32. P/N.SYS (PAL/NTSC System)
Toggle between PAL and NTSC video system mode
33. Return
Return to a previously viewed channel.

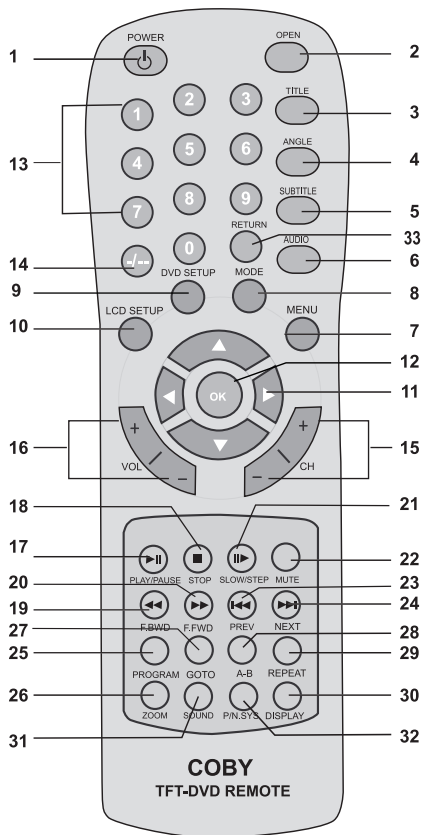

GETTING STARTED

Cable Connections

Do not connect the power until the first 3 connections have been made.

1. Connect TV RF sources to the coaxial TV antenna jack. TV RF sources may include: Over-the-Air receiving antennas or cable lines. You can use a 75 ohm coaxial cable to connect an outdoor antenna.
2. Connect Audio sources to the RCA Stereo Input jacks. Audio sources may include: DVD players, VCRs, or camcorders. Match the red and white ends of the RCA AV cable to the Red "L" and White "R" jacks on the rear panel of the TV.
3. Connect video sources to the Video Input jacks. Video sources may include: DVD players, VCRs, or camcorders.

Choose one of 3 connections:

- Composite Video (standard quality). Match the yellow end of the RCA AV cable to the yellow Video jack on the rear panel of the TV .
- S-Video (better quality). If the video source has an S-Video output jack, use an S-Video cable to connect it to the S-Video input jack on the rear panel of the TV.
- Component Video (best quality). The component video connection **must** be used for high-definition video (480i/p, 576i/p, 720i/p, 1080i). If the video source has component video output jacks, use component video cables to connect them to the component video input jacks on the rear panel of the TV.

4. Insert one end of the AC power cord to the Power input jack on the rear panel of the TV and the other end to an AC 100-240V wall outlet.

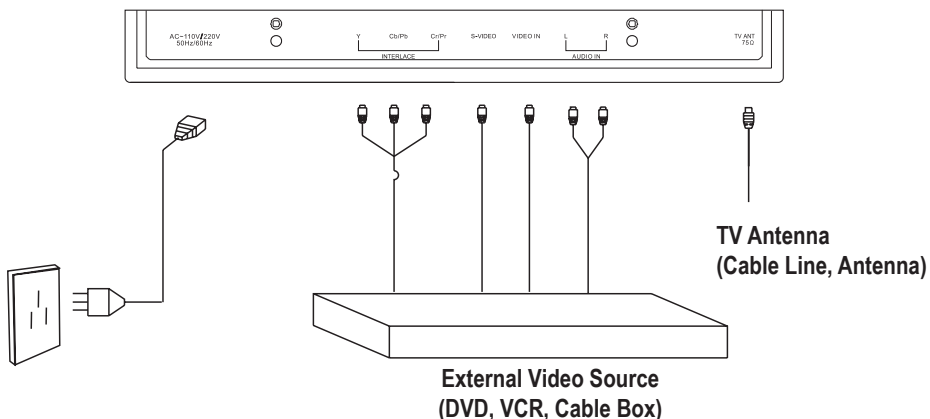
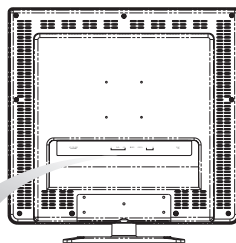

GETTING STARTED

Coaxial Digital Connection

Your player can output 5.1-channel surround sound audio through the Coaxial Digital Audio Out jack. You will need a Dolby Pro Logic Surround amplifier and an coaxial adapter cable to use this feature.

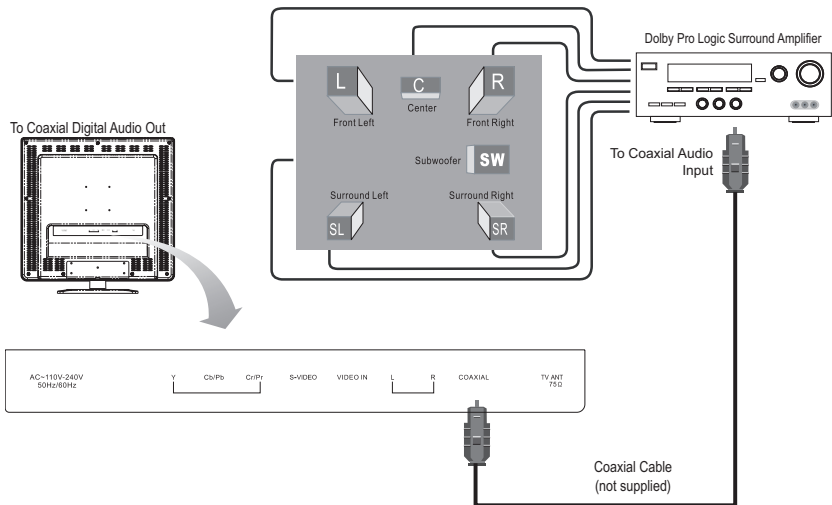

Remote Control

- Refer to the diagram. Remove the battery compartment cover located on the rear of the remote control. Insert 2 x "AAA" batteries, making sure to match their polarities (+/-) to the markings on the inside of the compartment. Replace the cover.
- To use the remote, point it at the remote sensor of the player. Operate the remote within 15 feet of the sensor and at an angle of +/- 60 degrees.
- Batteries in the remote will last for approximately 6 months under normal use. Replace the batteries if the remote control does not work. Do not mix old with new batteries, or different types of batteries.
- Remove the batteries from the remote if it will not be used for a long period of time.

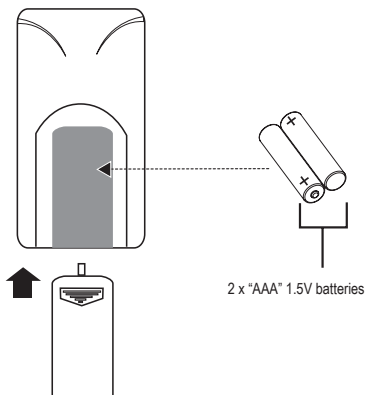

The battery used in this device may present a fire or chemical burn if mistreated. Do not recharge, disassemble, incinerate, or heat the battery (~212°F).

Keep batteries away from children.

Power Management

If the player will not be in use for a long period of time, set the Power Switch to the OFF position, remove the battery, and unplug the player.

TV FUNCTION

Use the TV function to watch television broadcasts.

Basic Operation

1. Prepare the antenna and power connections (see the [Getting Started](#) section for details).
2. Press POWER to turn the TV on.
3. Press MODE to set the TV to "TV" mode. You should see the antenna signal on-screen.
4. Press CH+/CH- to change the channel.

LCD Setup (TV)

The TV setup menu contains the following items: Picture, Sound, Channel, Display, and Parental Controls setup. LCD Setup may be accessed from TV, AV, or DVD modes.

1. Press LCD SETUP. The Picture Setup menu will appear on-screen.
2. Use the Navigation keypad (Up or Down) to select another item.
3. Press OK to enter the selected item.

Menu Navigation

To navigate the TV menu:

- Use the Navigation keypad (Up or Down) to move the selection cursor to select a desired feature or option in the menu.
- Press OK to confirm a selection to adjust.
- For items with a control bar:



1. Select the item and press OK. An enlarged control bar will be displayed.
2. Use the Navigation keypad (Left or Right) to adjust.
3. Press LCD SETUP to return when you have completed the adjustment.

TV FUNCTION

Picture Setup

Item	Description
Picture Mode	Set the Picture Mode preset (Normal, User, Bright, Soft)
Brightness	Set the brightness of the display screen.
Contrast	Set the contrast of the display screen.
Color	Set the color of the display screen.
Tint	Set the tint of the display screen.
Sharpness	Set the sharpness of the display screen.

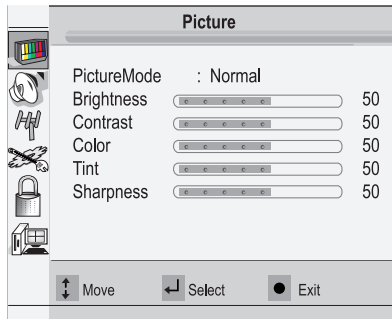

Sound Setup

Item	Description
Bass	Set the amount of Bass in the audio mix.
Treble	Set the amount of Treble in the audio mix.
Balance	Set the left/right channel balance of the audio mix.
MTS	Set the MTS audio option.

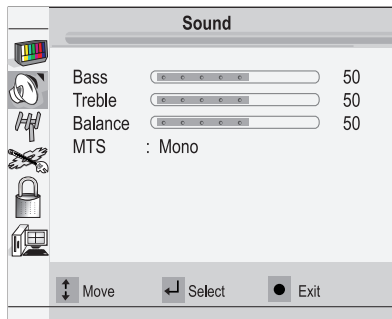

TV FUNCTION

Channel Setup

Item	Description
Auto Searching	Select to search and store all available broadcast channels.
Source	Select antenna system (Air/Cable)
Channel Skip	Select On/Off to skip unwanted channels
Fine Tuning	Select to fine-tune a channel
AFC Off	Select AFC On/Off

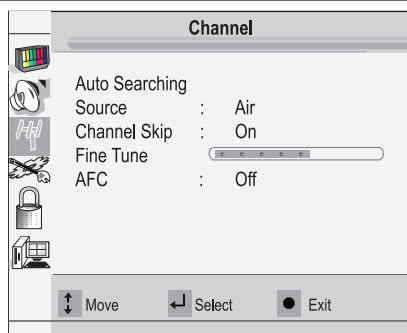

Display Setup

Item	Description
Language	Select the OSD menu language
Transparency	Adjust the menu transparency effect
Factory Reset	Reset to the factory-default settings
Captions	Select Caption mode (CC1, CC2, CC3, CC4, T1, T2, T3, T4, OFF)

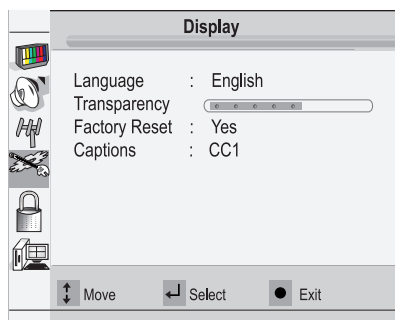

TV FUNCTION

Parental Control Setup

The Parental Control menu is password-protected. When the Parental Control menu is selected:

1. Press OK
2. Use the Numeric keypad to enter a 4-digit code (default password is: **1111**) and press then press OK. If the password is correct, the menu below will appear.

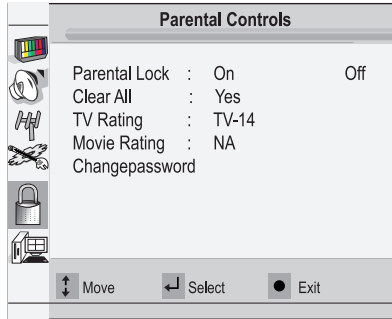
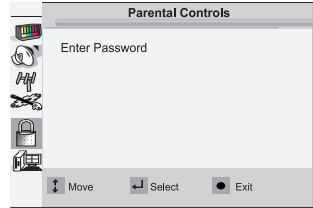

Item	Description
Parental Lock	Set the Parental Lock function On or Off
Clear All	Remove current Parental Lock restrictions
TV Rating	Set TV rating restrictions
Movie Rating	Set Movie rating restrictions
Change Password	Change the Parental Ctrl password. Enter a new password, and then enter the new password again to verify. DO NOT FORGET THE PASSWORD; this password cannot be reset.

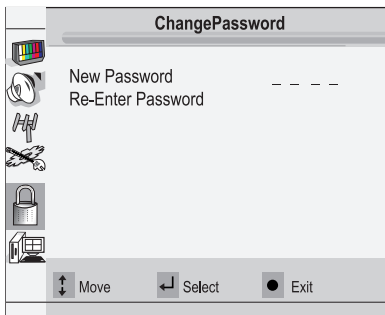

TV FUNCTION

TV Rating

TV broadcasts include a signal that classifies the contents of the program. When the TV Rating control is set, TV broadcasts that have been classified with a higher rating will be blocked.

- None: no restrictions (lowest rating)
- TV-Y: All children
- TV-Y7: For children aged 7 and above
- TV-G: General Audience
- TV-PG: Parental Guidance suggested
- TV-14: Not intended for ages under 14
- TV-MA: For mature audiences only (highest rating).

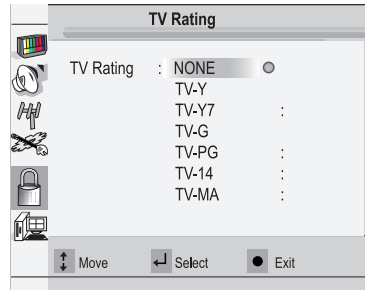

TV Ratings can be further divided and restricted by the following sub-categories:

- D: Suggestive dialogue
- L: Indecent language
- S: Sexual situations
- V: Violence

Movie Rating

TV broadcasts include a signal that classifies the contents of the program. When the Movie Rating control is set, movie broadcasts that have been classified with a higher rating will be blocked.

- NA: no restrictions (lowest rating)
- G: General Audience
- PG: Parental Guidance suggested
- PG-13: Not intended for ages under 13
- R: Restricted
- NC-17: Not intended for ages under 17
- X: For adults only (highest rating).

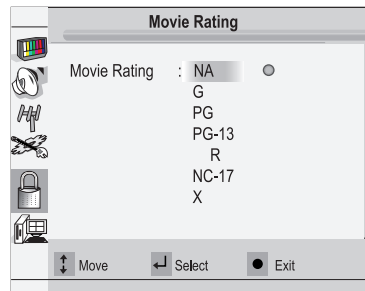

Blocked Program Notification

When a locked program is detected, the TV will display the screen shown to the right.

- You may release the lock by entering the 4-digit code.

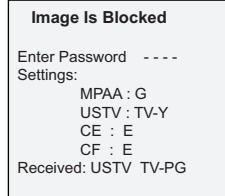

AV FUNCTION

Use the AV Function modes to enjoy programs from external video input sources.

Basic Operation

1. Prepare the AV Input and power connections (see the [Getting Started](#) section for details).
2. Press POWER to turn the TV on.
3. Press MODE to set the TV to the mode that corresponds with the Video Input jack that is in use [i.e., Video (Composite), S-Video, or Y-Cb/Pb-Cr/Pr (Component Video)].

You should see the Video Input signal on-screen.

AV Setup Menu

The AV setup menu contains the following items: Picture, Sound, and Display.

- When the Mode is set to VIDEO or S-VIDEO, the AV setup menu will also contain the item "Parental Controls".
 - When the Mode is set to Y-Cb/Pb-Cr/Pr or DVD, the AV setup menu will contain the item "Image Position".
1. Press LCD SETUP. The Picture Setup menu will appear on-screen.
 2. Use the Navigation keypad (Up or Down) to select another item.
 3. Press OK to enter the selected item.

Please refer to the [TV FUNCTION > LCD Setup](#) section for more setup option details.

Menu Navigation

To navigate the AV Setup menu:

- Use the Navigation keypad (Up or Down) to select (highlight) a desired feature or option in the menu.
- Press OK to confirm a selection to adjust.
- For items with a control bar:



1. Select the item and press OK. An enlarged control bar will be displayed.
2. Use the Navigation keypad (Left or Right) to adjust.
3. Press LCD SETUP to return when you have completed the adjustment.

AV FUNCTION

Image Position (Y-Cb/Pb-Cr/Pr and DVD Mode Only)

Item	Description
Image Position	Adjust the horizontal and vertical position of the image from +10 to -10

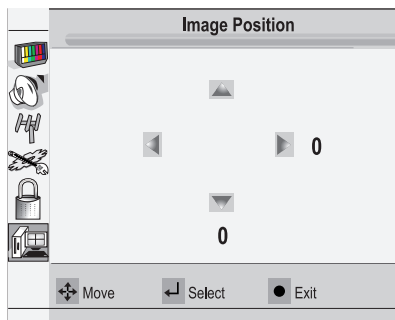

Sound (VIDEO or S-VIDEO Mode Only)

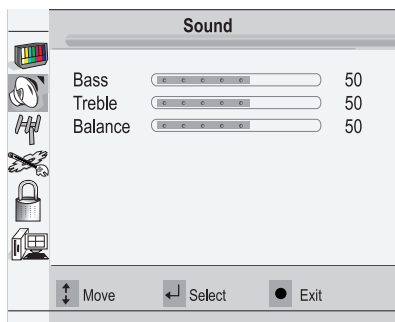

Please refer to the [TV FUNCTION > LCD Setup](#) section for more Sound, Picture, and Display option details.

DVD FUNCTION

Use the DVD function to play DVD, CD, and JPEG discs with the integrated DVD player.

Basic Operation

1. Prepare the connections (see the [Getting Started](#) section for details).
2. Press POWER to turn the TV on.
3. Press MODE to set the TV to "DVD" mode. You should see the DVD signal on-screen.
4. Load a disc into the player.

- Gently insert the disc into the slot. Do not insert objects other than discs compatible with your DVD player.
- The disc label should face the front of the television.

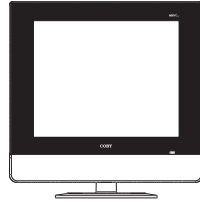

The disc label should face the front of the television.

Play/Pause/Stop

- Press to play the disc for the first time.
- Press during playback to pause. Press again to resume playback.
- Press during playback to stop the disc ("Pre-Stop"). Press to resume playback at the time-point at which the disc was stopped.
- Press when the disc is "Pre-Stopped" to stop playback completely. (When is pressed, the disc will start playing from the beginning.)

Previous/Next (Skip)

- Press to skip back one track (DVD, CD, etc).
- Press to skip forward one track (DVD, CD, etc).

Reverse/Forward (Scan)

- Press to reverse through the disc. Each successive press of will change the rate of reverse playback.
- Press to fast-forward through the disc. Each successive press of will change the rate of forward playback.

NORMAL — x2 — x4 — x8 — x20

Slow

- Press SLOW for slow-motion playback. Each successive press of SLOW will change the rate of slow-motion playback. Press to resume normal playback.

NORMAL — 1/2 — 1/3 — 1/4 — 1/5 — 1/6 — 1/7

Note:

Audio will be muted during fast-forward, fast-reverse, and slow-motion playback.

DVD FUNCTION

Zoom

Press ZOOM to change the magnification level of the picture.

- During DVD playback, each successive press of ZOOM will change the level of magnification to: Zoom 2x, Zoom 3x, Zoom 4x, Zoom 1/2x, Zoom 1/3x, Zoom 1/4x, Normal.

Repeat Mode

Press REPEAT to change the repeat mode of the player. Each successive press of REPEAT will change the mode as follows:

- DVD Playback: Repeat Chapter, Repeat Title, Off
- CD Playback: Repeat 1, Repeat All, Repeat Off

Note:

Some DVD discs do not support Repeat mode.

A-B Repeat Mode

To repeat playback of a specific section of a disc (loop):

1. Press A-B to set the desired start point ("A") of the section to be repeated.
2. Press A-B again to set the desired end point ("B") of the section to be repeated.
3. The section "A-B" will now play repeatedly as a loop. Press A-B again to resume normal playback.

GOTO (Search)

Press GOTO to go directly to a desired point of a disc.

1. Press GOTO once to display the Search Bar shown.
2. Press the LEFT/RIGHT navigation keys to select (highlight) an entry field.
 - **For DVD discs:** use the Numeric keypad to input the desired chapter, title, or time code. Press CLEAR to cancel any input errors.

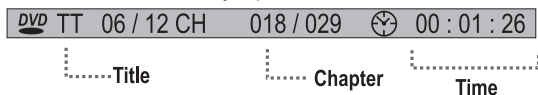

- **For CD discs:** use the Numeric keypad to input the desired track number or time code. Press CLEAR to cancel any input errors.

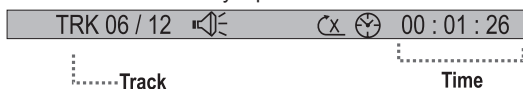

3. Press OK to confirm and execute the search or press GOTO to exit search mode.

Note:

Some DVD discs do not support GOTO (Search).

DVD FUNCTION

Program

Enter Program mode to a custom sequence of up to 16 tracks to be played.

DVD Program Mode

1. Press PROGRAM to display the Program screen.
2. Use the Navigation keypad to select (highlight) an entry field.
 - **For DVD discs:** use the Numeric keypad to input the desired Title (T) or Chapter (C) in each Program Sequence field. Press CLEAR to cancel any input errors.

PROG			
T	C	T	C
1 --	5 --	9 --	13 --
2 --	6 --	10 --	14 --
3 --	7 --	11 --	15 --
4 --	8 --	12 --	16 --
PLAY		CLEAR	

- **For CD discs:** use the Numeric keypad to input the desired track number in each Program Sequence field. Press CLEAR to cancel any input errors.

PROG			
1 ---	5 ---	9 ---	13 ---
2 ---	6 ---	10 ---	14 ---
3 ---	7 ---	11 ---	15 ---
4 ---	8 ---	12 ---	16 ---
PLAY		CLEAR <OK>	

3. To reset all Program Sequence fields to blank, use the Navigation keypad to select CLEAR and press OK to confirm.
4. To start Program playback, use the Navigation keypad to select PLAY and press OK to confirm.

Sound

Press Sound to select a digital equalizer preset: Standard, Classic, Rock, Jazz, Pop, or User.

DVD FUNCTION

DVD Functions

Menu

DVD discs usually contain several titles and chapters.

- Press MENU to access the root (top-level) menu
- Use the Navigation Keypad to select the desired title/chapter and then press OK to confirm.
- Press MENU during DVD playback to return to the DVD's start menu.

Audio

Press AUDIO to select an audio language track for multi-language DVD discs. There may be up to 8 audio languages on a DVD disc.

Subtitle

Press SUBTITLE to select a subtitle language for multi-subtitle DVD discs.

Angle

Press ANGLE to select an alternate angle for multi-angle DVD discs. A DVD may contain scenes recorded from various camera positions to allow you to enjoy the same scene from different perspectives.

- DVDs that contain multiple angles are usually noted as such on the DVD case.

CD Playback Functions

Your player will play all audio tracks of a CD disc by default.

JPEG Playback Functions

JPEG is a common picture format that requires small amounts of storage per image with only a small sacrifice of resolution. Hundreds of pictures may be stored on a disc in this format. In order to view JPEG photo albums, you may ask your film development company to create a "PICTURE CD" when they develop your film.

Normal Playback

1. Load a JPEG disc into the player.
2. Use the Navigation keypad (Up/Down) to select a submenu and press OK to confirm.
3. Use the Navigation keypad (Up/Down) to select the contents.
4. Press STOP to return to the previous menu during playback.

DVD FUNCTION

Picture Rotation

Use the Navigation keypad to rotate a picture while it is displayed. There are four kinds of rotational modes:

- UP: Inversion (Reflect Horizontal)
- DOWN: Enantiomorphism (Reflect Vertical)
- LEFT: Rotate Left
- RIGHT: Rotate Right

Zoom

Press ZOOM to magnify a picture while it is displayed. Each successive press of ZOOM will change the magnification level.

- Use the Navigation keypad to pan around a magnified picture.

NOTE:

The JPEG disc must be mastered with Picture Rotation and Zoom function support .

DVD Setup Menu

The DVD setup menu contains the following items: System, Language, Audio, and Video Setup.

1. Press DVD SETUP while in DVD mode. The DVD Setup menu will appear on-screen.
2. Use the Navigation keypad to select an item.
3. Press OK to enter the selected item.
4. To exit the DVD Setup menu, press DVD SETUP.

System

Item	Description
TV System	NTSC/PAL/AUTO. NTSC is the TV System used in North America.
Screen Saver	ON/OFF The screensaver prevents burn-in damage to the player's screen.
TV Type	4:3 PS (Pan & Scan) / 4:3 LB (Letterbox) / 16:9 (Widescreen) Sets the aspect ratio of the display.
Rating	LEVEL 1 to LEVEL 8 Sets the maturity rating level of the player. The player will not play any discs rated higher than this setting. <u>This setting is password protected (the default password is: 8888).</u>
Password	Change the Parental Ctrl password. Enter the old password, the new password, and then the new password again to verify. DO NOT FORGET THE PASSWORD; this password cannot be reset.
Default	Resets all settings to their factory-default state. This will not reset the Parental Ctrl password.

DVD FUNCTION

Language

Item	Description
OSD Lang	Sets the language of the player's on-screen display.
Menu Lang	Sets the default menu language of loaded DVDs.
Audio Lang	Sets the default language audio track of loaded DVDs.
Subtitle Lang	Sets the default subtitle track of loaded DVDs.

Audio

Item	Description
Audio Out	<p>SPDIF/OFF, SPDIF/RAW, SPDIF/PCM</p> <p>Sets the player's Coaxial Digital Audio Out signal. For use with 5.1-channel receivers (see your receiver's manuals for more details).</p> <ul style="list-style-type: none">• Use SPDIF/OFF when the coaxial digital audio connection is not in use to minimize circuit interference.• Use SPDIF/RAW when connected to a 5.1-channel system.• Use SPDIF/PCM when connected to a 2-channel system.

Video

Item	Description
Brightness	Adjust the screen's brightness.
Contrast	Adjust the screen's contrast.
Hue	Adjust the screen's hue.
Saturation	Adjust the screen's color saturation.
Sharpness	Adjust the screen's sharpness.

TROUBLESHOOTING

If you have a problem with this TV, please read the troubleshooting guide below and check our website at www.cobyusa.com for Frequently Asked Questions (FAQs) and firmware updates. If these resources do not resolve the problem, please contact Technical Support.

COBY Electronics Technical Support

56-65 Rust Street
Maspeth, NY 11378

Hours: Monday to Friday, 8:30 AM–11:00 PM EST
Saturday to Sunday, 9:00 AM–11:00 PM EST

Email: techsupport@cobyusa.com

Phone: 800-681-2629 or 718-416-3197

Web: www.cobyusa.com

There is no power to the device.

- Ensure that the Power Switch is physically set to the ON position.
- Ensure that the power cord is securely connected to the TV and the proper wall outlet.
- Ensure that the main power has been switched on.

The device does not play.

- Ensure that the TV, Movie, or DVD rating levels does not exceed the player's rating level.
- Moisture may have condensed inside the player. Remove the disc and leave the player on for 1-2 hours and then try again.

There is no picture.

- Ensure that the TV set has been powered on and is set to the correct mode (Composite, S-Video, Component Video, etc.)
- Ensure that the connections are secure and correct.
- Check if the connection cables are damaged.

The picture is noisy or distorted.

- Reset your TV's color system (NTSC).
- If an antenna is in use, try repositioning it for better reception.

There is no sound or distorted sound.

- Ensure that the TV and amplifier have been turned on and properly set up.
- Ensure that the TV and amplifier connections are secure and correct.
- Ensure that the MUTE function of the TV or Amplifier is not engaged.

The remote control doesn't work.

- Ensure that there are no obstacles between the remote and the player.
- Point the remote at the remote sensor on the main unit.
- Ensure that the batteries in the remote retain a charge and have been installed correctly.
- Try replacing the remote's batteries.

TROUBLESHOOTING

The unit has malfunctioned.

- Unplug the TV and let it rest for 30 minutes. Plug it back in, and the restore function should reset the TV.

SPECIFICATIONS

Display Type	19" TFT LCD
Display Resolution	1280 x 1024
Display Pixel Pitch	0.264mm
Display Contrast	500:1
Display Brightness	250 cd/m ²
TV System	NTSC-M
TV Tuning system	FS with PLL
	VHF-L: 55.25MHZ ~ 160.00 MHZ VHF-H: 160.00 MHZ ~ 442.00 MHZ UHF: 442.00 ~ 801.25 MHZ
Power Supply	AC: 110-240V 50/60Hz
Power Consumption	Working: 40W (max) Standby: <2W
Video Input	Component Video S-Video Composite Video
Audio Input	RCA Stereo Audio
Audio Output	Coaxial Digital Audio Integrated Stereo Speakers (5W x 2)
Operating Temperature	50°F - 104°F
Unit Dimensions	19.92" x 15.47" x 6.1" (WHD)
Weight	11.7 lbs

Specifications and manual are subject to change without prior notice.

COBY Electronics Corp.

56-65 Rust Street
Maspeth, NY 11378

www.cobyusa.com
www.ecoby.com