

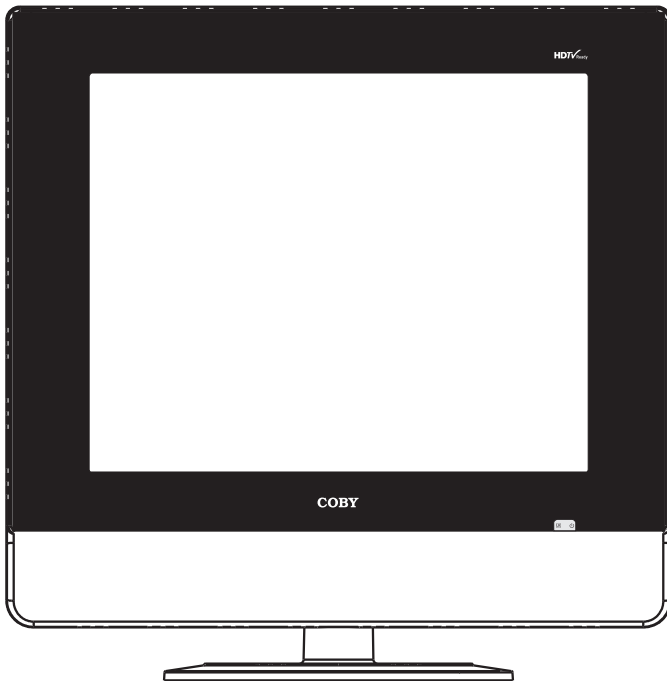

**19" TFT LCD FLATSCREEN TELEVISION**



## **Instruction Manual**

**Please read this manual carefully before operation.**

# PRECAUTIONS

	<b>CAUTION</b> WARNING: SHOCK HAZARD. DO NOT OPEN. AVIS: RISQUE DE CHOC ELECTRIQUE. NE PAS OUVRIR	
<b>CAUTION:</b> TO REDUCE THE RISK OF FIRE AND ELECTRIC SHOCK, DO NOT REMOVE THE COVER (OR BACK) OF THE UNIT. REFER SERVICING ONLY TO QUALIFIED SERVICE PERSONNEL.		

## For Customer Use:

Enter below the serial number that is located on the bottom of the unit. Retain this information for future reference.

Model No. \_\_\_\_\_ TF-TV1901 \_\_\_\_\_

Serial No. \_\_\_\_\_



The lightning flash with arrowhead symbol within an equilateral triangle is intended to alert the user to the presence of uninsulated "dangerous voltage" within the product's enclosure that may be of sufficient magnitude to constitute a risk of electric shock.



The exclamation point within an equilateral triangle is intended to alert the user to the presence of important operation and servicing instructions in the literature accompanying the appliance.

## WARNING:

To prevent fire or shock hazard, do not expose this device to rain or moisture. Dangerous high voltage is present inside the enclosure. Do not open the cabinet.

## FCC Notice:

This equipment has been tested and found to comply with the limits for a Class B digital device pursuant with the FCC Rules, Part 15. These limits are designed to provide reasonable protection against harmful interference in a residential installation. This equipment generates, uses, and can radiate radio frequency energy, and if not installed and used in accordance with the instructions may cause harmful interference to radio communication.

## CAUTION:

To prevent electric shock, match wide blade of plug to wide slot of outlet and fully insert.

## NOTE:

Before plugging the power cord into an AC outlet, make sure that all the connections have been made.



For recycling or disposal information about this product, please contact your local authorities or the Electronics Industries Alliance: [www.eiae.org](http://www.eiae.org).

# SAFETY INSTRUCTIONS

1. **Read Instructions:** All the safety and operating instructions should be read before the product is operated.
2. **Retain Instructions:** The safety and operating instructions should be retained for future reference.
3. **Heed Warnings:** All warnings on the product and in the operating instructions should be adhered to.
4. **Follow Instructions:** All operating and usage instructions should be followed.
5. **Cleaning:** Unplug this product from the wall outlet before cleaning. Do not use liquid cleaners or aerosol cleaners. Use a damp cloth for cleaning.
6. **Attachments:** Use only attachments recommended by the manufacturer. Use of other attachments may be hazardous.
7. **Water and Moisture:** Do not use this product near water (e.g., near a bath tub, washbowl, kitchen sink, laundry tub, in wet basements, or near a swimming pool and the like).
8. **Accessories:** Do not place this product on an unstable cart, stand, tripod, bracket, or table. Use only with carts, stands, tripods, brackets, or tables recommended by the manufacturer or sold with the product. Any mounting of the product should follow the manufacturer's instructions and should use a mounting accessory recommended by the manufacturer.
9. A product and cart combination should be moved with care. Quick stops, excessive force, and uneven surfaces may cause the product and cart combination to overturn.
10. **Ventilation:** Slots and openings in the cabinet are provided for ventilation to ensure reliable operation of the product and to protect it from overheating. These openings should never be blocked by placing the product on a bed, sofa, rug, or other similar surface. This product should not be placed in a built-in installation such as a bookcase or rack unless proper ventilation is provided or the manufacturer instructions have been adhered to.
11. **Power Sources:** This product should be operated only from the type of power source indicated on the rating label. If you are not sure of the type of power supply to your home, consult your product dealer or local power company. For products intended to operate from battery power or other sources, refer to the operating instructions.
12. **Grounding or Polarization:** This product may be equipped with a polarized alternating-current line plug that has one blade wider than the other. This plug will only fit into the power outlet in one direction. This is a safety feature. If you are unable to insert the plug fully into the outlet, try reversing the direction of the plug. If the plug should still fail to fit, contact an electrician to replace the obsolete outlet. Do not defeat the safety purpose of the polarized plug.
13. **Power-Cord Protection:** Power supply cords should be routed so that they are not likely to be walked on or pinched by items placed upon or against them, paying particular attention to cords at plugs, convenience receptacles, and at the point which they exit from the product.
14. **Protective Attachment Plug:** The product may be equipped with an attachment plug with overload protection. This is a safety feature. See the operating instructions for replacement or directions to reset the protective device. If replacement of the plug is required, be sure the service technician has used a replacement plug that has the same overload protection as the original plug as specified by the manufacturer.



# SAFETY INSTRUCTIONS

- Outdoor Antenna Grounding: If an outside antenna is connected to the product, be sure the antenna system is grounded so as to provide some protection against voltage surges and built-up static charges. Article 810 of the National Electrical Code, ANS/NFPA 70 provides information with regard to proper grounding of the mast and supporting structure, grounding of the lead-in wire to an antenna-discharge unit, size of grounding conductors, location of antenna-discharge unit, connection to grounding electrodes, and requirements for the grounding electrode (see figure).

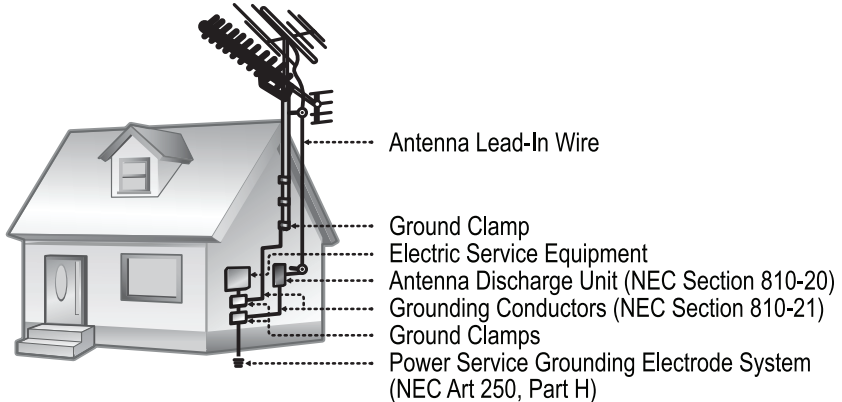

- Lightning: For added protection for this product, unplug it from the wall outlet and disconnect the antenna or cable system during a lightning storm or when it is left unattended and unused for long periods of time. This will prevent damage to the product due to lightning or power-line surges.
- Power Lines: An outside antenna system should not be located in the vicinity of overhead power lines or other electric light or power circuits, or where it can fall into such power lines or circuits. When installing an outside antenna system, extreme care should be taken to keep from touching such power lines or circuits, as contact with them might be fatal.
- Overloading: Do not overload wall outlets, extension cords, or integral convenience receptacles as this can result in a risk of fire or electric shock.
- Object and Liquid Entry: Never push objects of any kind into this product through openings as they may touch dangerous voltage points or shout-out parts that could result in a fire or electric shock. Never spill liquid of any kind on the product.
- Servicing: Do not attempt to service this product yourself as opening or removing covers may expose you to dangerous voltage or other hazards. Refer all servicing to qualified service personnel.
- Damage Requiring Service: Unplug this product from the wall outlet and refer servicing to qualified service personnel under the following conditions: a) when the power-supply or plug is damaged; b) if liquid has been spilled or if objects have fallen into the product; c) if the product has been exposed to rain or water; d) if the product does not operate normally by following the operating instructions. Adjust only those controls that are covered by the operating instructions as improper adjustment of other controls may result in damage and will often require extensive work by a qualified technician to restore the product to its normal operation; e) if the product has been dropped or damaged in any way; f) when the product exhibits a distinct change in performance—this indicates a need for service.

# SAFETY INSTRUCTIONS

22. **Replacement Parts:** When replacement parts are required, be sure that your service technician has used replacement parts specified by the manufacturer or have the same characteristics as the original part. Unauthorized substitutions may result in fire, electric shock, or other hazards.
23. **Safety Check:** Upon completion of any service or repairs to this product, ask the service technician to perform safety checks to ensure that the product is in proper operating condition.
24. **Wall or Ceiling Mounting:** The product should be mounted to a wall or ceiling only as recommended by the manufacturer.
25. **Heat:** The product should be situated away from heat sources such as radiators, heat registers, stoves, or other products (including amplifiers) that produce heat.

# TABLE OF CONTENTS

PRECAUTIONS.....	2
SAFETY INSTRUCTIONS.....	3
TABLE OF CONTENTS.....	6
PACKAGE CONTENTS.....	7
LOCATION OF CONTROLS.....	8
Front View.....	8
Right Panel View.....	8
Rear Panel View.....	8
Remote Control.....	9
GETTING STARTED.....	10
Cable Connections.....	10
Remote Control.....	11
Power Management.....	11
TV FUNCTION.....	12
Basic Operation.....	12
TV Setup Menu.....	12
Menu Navigation.....	12
Picture Setup.....	13
Sound Setup.....	13
Channel Setup.....	14
Display Setup.....	14
Parental Control Setup.....	15
TV Rating.....	16
Movie Rating.....	16
Blocked Program Notification.....	16
AV FUNCTION.....	17
Basic Operation.....	17
AV Setup Menu.....	17
Menu Navigation.....	17
Image Position (Y-Cb/Pb-Cr/Pr Mode Only).....	18
TROUBLESHOOTING.....	19
SPECIFICATIONS.....	21

# PACKAGE CONTENTS

Please make sure the following items are included with your LCD TV/monitor. If any items are missing, contact your local dealer.

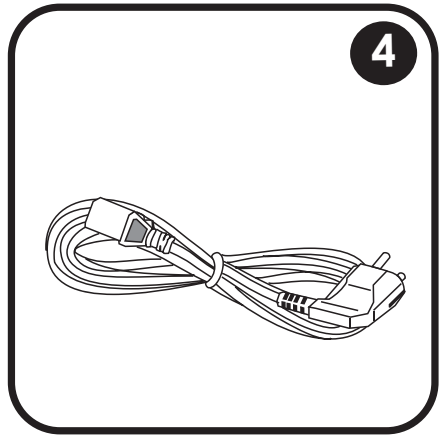
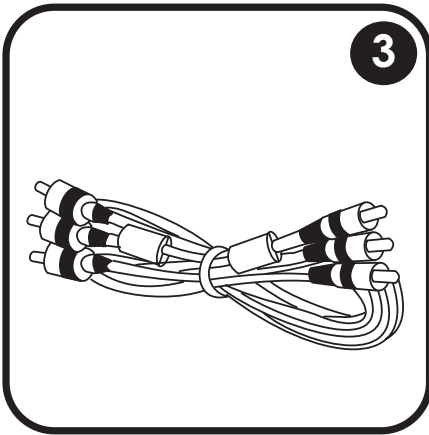
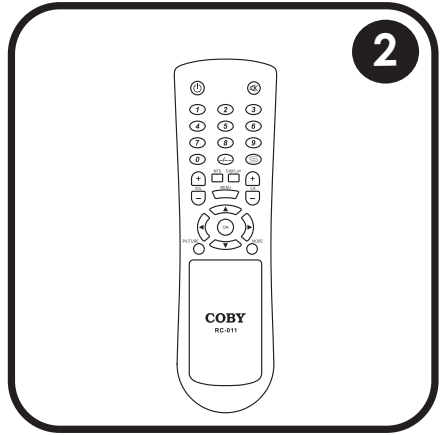
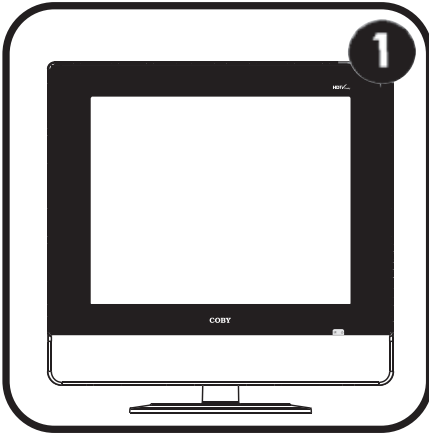

1. TF-TV1901
2. Remote Control
3. AV Cable
4. AC Power Cord

# LOCATION OF CONTROLS

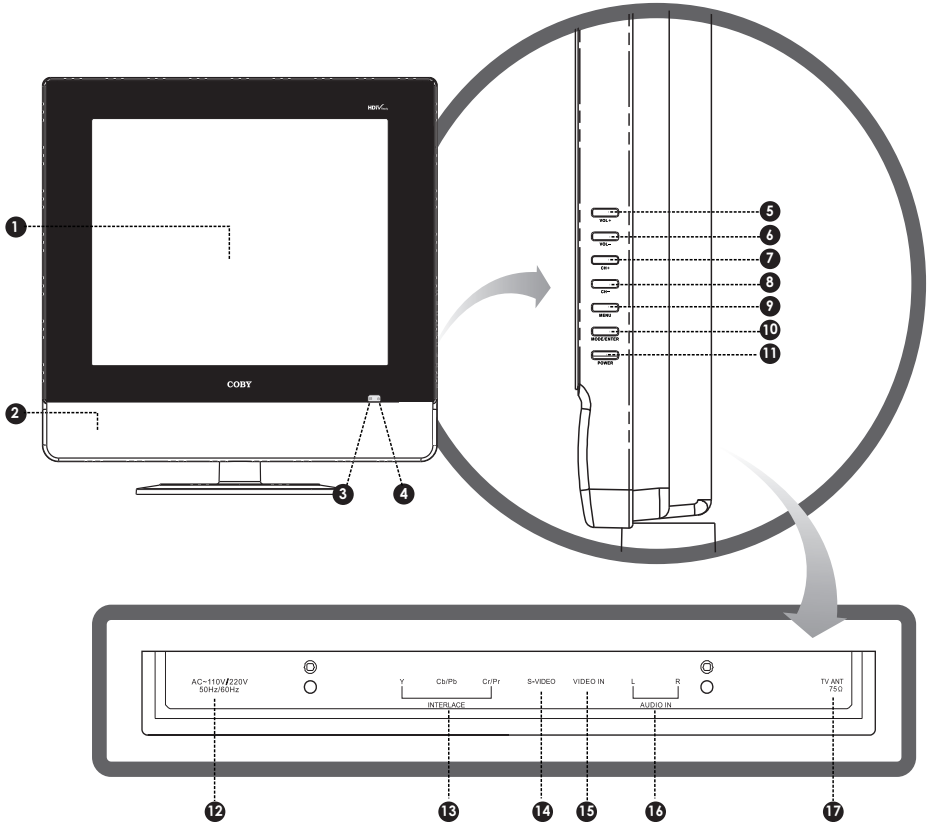

## Front View

1. TFT LCD Display
2. Stereo Speakers
3. Remote Sensor
4. Power Indicator

## Right Panel View

5. Volume Up Button
6. Volume Down Button
7. Channel Up Button
8. Channel Down Button
9. Menu Button
10. Mode/Enter Button
11. Power Button

## Rear Panel View

12. Power In Jack
13. Component Video Input Jacks
14. S-Video Input Jack
15. Composite Video Input Jacks
16. RCA Stereo Audio Input Jacks
17. Coaxial Antenna Input



# LOCATION OF CONTROLS

## **Remote Control**

1. Power  
Turn the TV On/Off
2. MTS  
Set the TV AUDIO mode
3. Volume Up/Down  
Adjust the Volume level
4. Menu  
Access the Setup Menu
5. Picture  
Change the Picture preset mode  
(Normal, User, Soft, Bright)
6. Mute  
Turn the Volume On/Off
7. Numeric Keypad  
Enter numeric input data.  
Change the channel directly.
8. Return  
Return to a previously viewed channel
9. Display  
Show status information on-screen
10. Channel Up/Down  
Change the channel
11. Navigation Keypad  
Move the selection cursor.  
Press OK to confirm selections.
12. Mode  
Change the Video Input mode  
(Component, TV, Composite Video,  
S-Video)

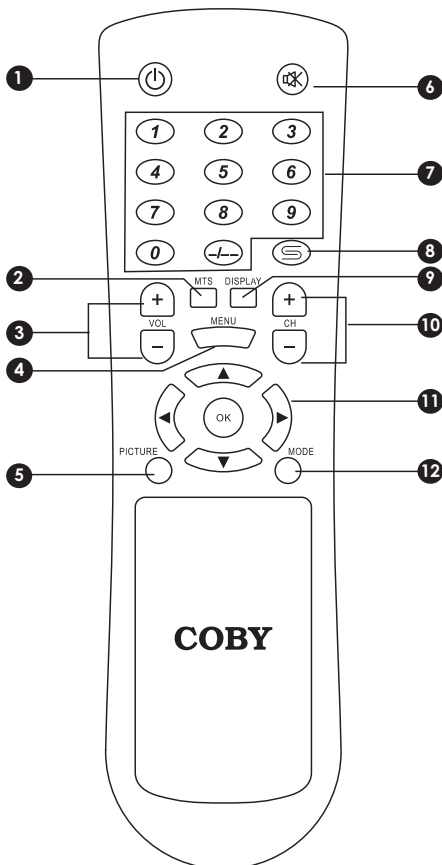

# GETTING STARTED

## Cable Connections

Do not connect the power until the first 3 connections have been made.

1. Connect TV RF sources to the coaxial TV antenna jack. TV RF sources may include: Over-the-Air receiving antennas or cable lines. You can use a 75 ohm coaxial cable to connect an outdoor antenna.
2. Connect Audio sources to the RCA Stereo Input jacks. Audio sources may include: DVD players, VCRs, or camcorders. Match the red and white ends of the RCA AV cable to the Red "L" and White "R" jacks on the rear panel of the TV.
3. Connect video sources to the Video Input jacks. Video sources may include: DVD players, VCRs, or camcorders.

### Choose one of 3 connections:

- Composite Video (standard quality). Match the yellow end of the RCA AV cable to the yellow Video jack on the rear panel of the TV .
  - S-Video (better quality). If the video source has an S-Video output jack, use an S-Video cable to connect to the S-Video input jack on the rear panel of the TV.
  - Component Video (best quality). Use the component video connection for high-definition video. If the video source has component video output jacks, use component video cables to connect them to the component video input jacks on the rear panel of the TV.
4. Insert one end of the AC power cord to the Power input jack on the rear panel of the TV and the other end to an AC 100-240V wall outlet.

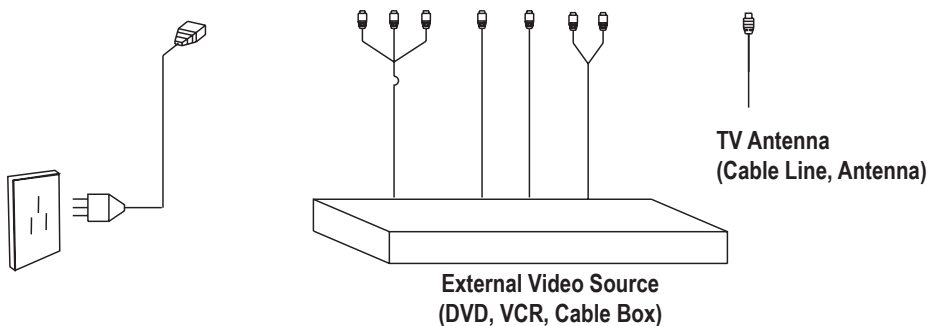
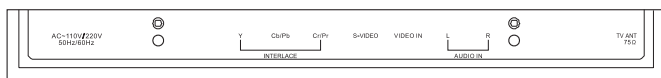
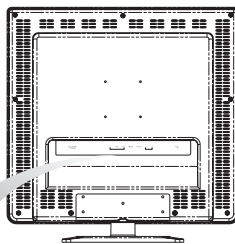

# GETTING STARTED

## **Remote Control**

- Refer to the diagram. Remove the battery compartment cover located on the rear of the remote control. Insert 2 x "AAA" batteries, making sure to match their polarities (+/-) to the markings on the inside of the compartment. Replace the cover.
- To use the remote, point it at the remote sensor of the player. Operate the remote within 15 feet of the sensor and at an angle of +/- 60 degrees.
- Batteries in the remote will last for approximately 6 months under normal use. Replace the batteries if the remote control does not work. Do not mix old with new batteries, or different types of batteries.
- Remove the batteries from the remote if it will not be used for a long period of time.

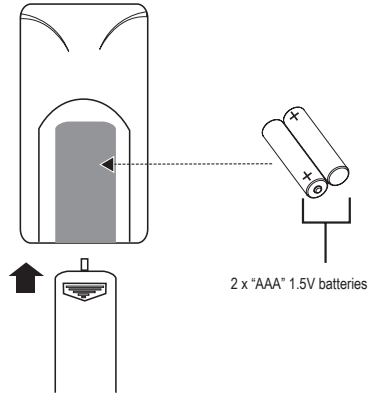

*The battery used in this device may present a fire or chemical burn if mistreated. Do not recharge, disassemble, incinerate, or heat the battery (~212°F).*

*Keep batteries away from children.*

## **Power Management**

If the player will not be in use for a long period of time, set the Power Switch to the OFF position, remove the battery, and unplug the player.

# TV FUNCTION

## **Basic Operation**

1. Prepare the antenna and power connections (see the [Getting Started](#) section for details).
2. Press POWER to turn the TV on.
3. Press MODE to set the TV to “TV MODE”. You should see the antenna signal on-screen.
4. Press CH+/CH- to change the channel.

## **TV Setup Menu**

The TV setup menu contains the following items: Picture, Sound, Channel, Display, and Parental Controls setup.

1. Press MENU. The Picture Setup menu will appear on-screen.
2. Use the Navigation keypad (Up or Down) to select another item.
3. Press OK to enter the selected item.

## **Menu Navigation**

To navigate the TV menu:

- Use the Navigation keypad (Up or Down) to select (highlight) a desired feature or option in the menu.
- Press OK to confirm a selection to adjust.
- For items with a control bar:



1. Select the item and press OK. An enlarged control bar will be displayed.
2. Use the Navigation keypad (Left or Right) to adjust.
3. Press MENU to return when you have completed the adjustment.

# TV FUNCTION

## Picture Setup

Item	Description
Picture Mode	Set the Picture Mode preset (Normal, User, Bright, Soft)
Brightness	Set the brightness of the display screen.
Contrast	Set the contrast of the display screen.
Color	Set the color of the display screen.
Tint	Set the tint of the display screen.
Sharpness	Set the sharpness of the display screen.

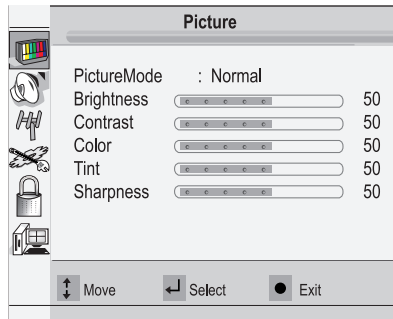

## Sound Setup

Item	Description
Bass	Set the amount of Bass in the audio mix.
Treble	Set the amount of Treble in the audio mix.
Balance	Set the left/right channel balance of the audio mix.
MTS	Set the color of the display screen.

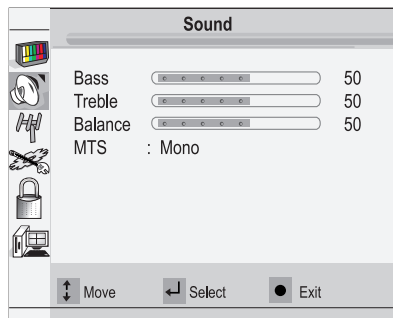

# TV FUNCTION

## Channel Setup

Item	Description
Auto Searching	Select to search and store all available broadcast channels.
Source	Select antenna system (Air/Cable)
Channel Skip	Select On/Off to skip unwanted channels
Fine Tuning	Select to fine-tune a channel
AFC Off	Select AFC On/Off

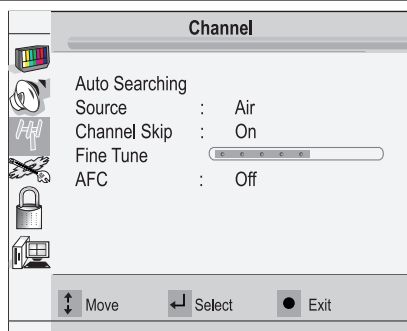

## Display Setup

Item	Description
Language	Select the OSD menu language
Transparency	Adjust the menu transparency effect
Factory Reset	Reset to the factory-default settings
Captions	Select Caption mode (CC1, CC2, CC3, CC4, T1, T2, T3, T4, OFF)

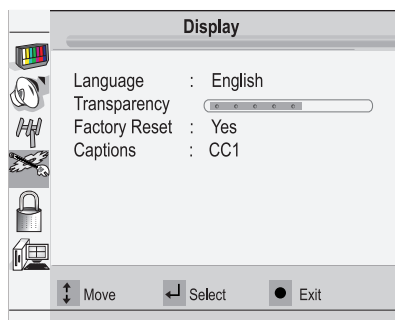

# TV FUNCTION

## Parental Control Setup

The Parental Control menu is password-protected. When the Parental Control menu is selected:

1. Press OK
2. Use the Numeric keypad to enter a 4-digit code (default password is: **1111**) and press then press OK. If the password is correct, the menu below will appear.

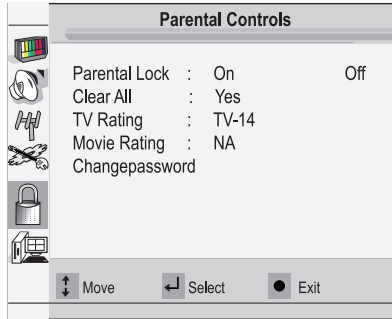
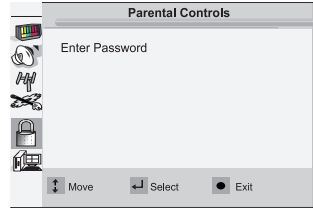

Item	Description
Parental Lock	Set the Parental Lock function On or Off
Clear All	Remove current Parental Lock restrictions
TV Rating	Set TV rating restrictions
Movie Rating	Set Movie rating restrictions
Change Password	Change the Parental Ctrl password. Enter a new password, and then enter the new password again to verify. <b>DO NOT FORGET THE PASSWORD; this password cannot be reset.</b>

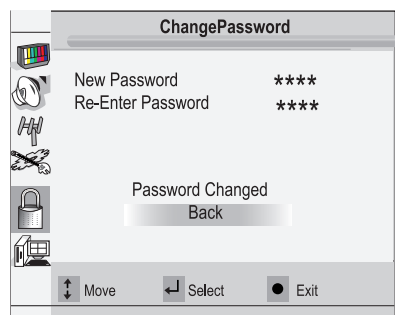
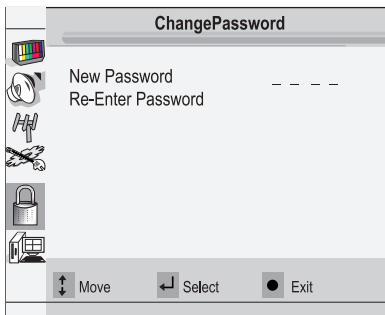

# TV FUNCTION

## TV Rating

TV broadcasts include a signal that classifies the contents of the program. When the TV Rating control is set, TV broadcasts that have been classified with a higher rating will be blocked.

- None: no restrictions (lowest rating)
- TV-Y: All children
- TV-Y7: For children aged 7 and above
- TV-G: General Audience
- TV-PG: Parental Guidance suggested
- TV-14: Not intended for ages under 14
- TV-MA: For mature audiences only (highest rating).

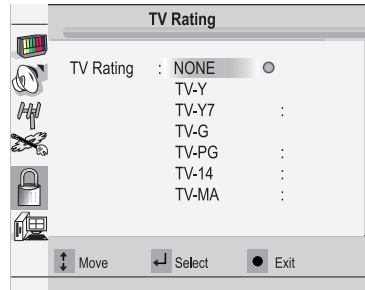

TV Ratings can be further divided and restricted by the following sub-categories:

- D: Suggestive dialogue
- L: Indecent language
- S: Sexual situations
- V: Violence

## Movie Rating

TV broadcasts include a signal that classifies the contents of the program. When the Movie Rating control is set, movie broadcasts that have been classified with a higher rating will be blocked.

- NA: no restrictions (lowest rating)
- G: General Audience
- PG: Parental Guidance suggested
- PG-13: Not intended for ages under 13
- R: Restricted
- NC-17: Not intended for ages under 17
- X: For adults only (highest rating).

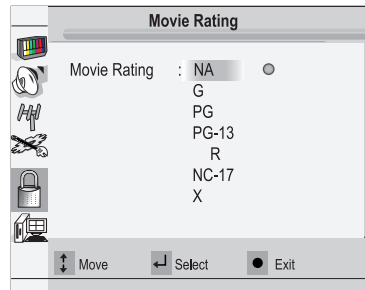

## Blocked Program Notification

When a locked program is detected, the TV will display the screen shown to the right.

- You may release the lock by entering the 4-digit code.

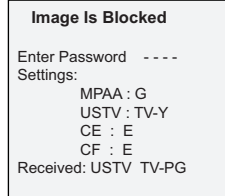



# AV FUNCTION

## **Basic Operation**

1. Prepare the AV Input and power connections (see the [Getting Started](#) section for details).
2. Press POWER to turn the TV on.
3. Press MODE to set the TV to the mode that corresponds with the Video Input jack that is in use (i.e., Video, S-Video, or Component Video (Y-Cb/Pb-Cr/Pr). You should see the Video Input signal on-screen.

## **AV Setup Menu**

The AV setup menu contains the following items: Picture, Sound, and Display.

- When the Mode is set to VIDEO or S-VIDEO, the AV setup menu will also contain the item "Parental Controls".
  - When the Mode is set to Y-Cb/Pb-Cr/Pr (COMPONENT VIDEO) the AV setup menu will contain the item "Image Position".
1. Press MENU. The Picture Setup menu will appear on-screen.
  2. Use the Navigation keypad (Up or Down) to select another item.
  3. Press OK to enter the selected item.

***Please refer to the [TV FUNCTION](#) section for more setup option details.***

## **Menu Navigation**

To navigate the AV Setup menu:

- Use the Navigation keypad (Up or Down) to select (highlight) a desired feature or option in the menu.
- Press OK to confirm a selection to adjust.
- For items with a control bar:
  1. Select the item and press OK. An enlarged control bar will be displayed.



2. Use the Navigation keypad (Left or Right) to adjust.
3. Press MENU to return when you have completed the adjustment.

# AV FUNCTION

## Image Position (Y-Cb/Pb-Cr/Pr Mode Only)

Item	Description
Image Position	Adjust the horizontal and vertical position of the image from +10 to -10

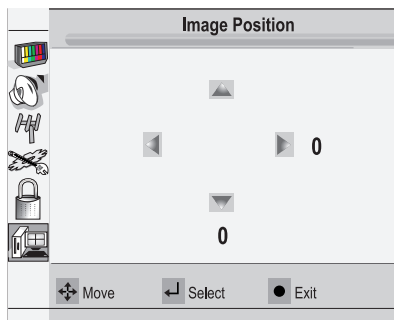

Please refer to the TV FUNCTION section for more setup option details.

# TROUBLESHOOTING

If you have a problem with this TV, please read the troubleshooting guide below and check our website at [www.cobyusa.com](http://www.cobyusa.com) for Frequently Asked Questions (FAQs) and firmware updates. If these resources do not resolve the problem, please contact Technical Support.

## **COBY Electronics Technical Support**

56-65 Rust Street  
Maspeth, NY 11378

Hours: Monday to Friday, 8:30 AM–11:00 PM EST  
Saturday to Sunday, 9:00 AM–11:00 PM EST

Email: [techsupport@cobyusa.com](mailto:techsupport@cobyusa.com)

Phone: 800-681-2629 or 718-416-3197

Web: [www.cobyusa.com](http://www.cobyusa.com)

### ***There is no power to the device.***

- Ensure that the Power Switch is physically set to the ON position.
- Ensure that the AC adapter cord is securely connected to the TV and the proper wall outlet.
- Ensure that the main power has been switched on.

### ***The device does not play.***

- Ensure that the TV and Movie rating levels does not exceed the TV's.
- Moisture may have condensed inside the player. Remove the disc and leave the player on for 1-2 hours and then try again.

### ***There is no picture.***

- Ensure that the AV switch is set to the correct mode (AV IN or AV OUT).
- Ensure that the TV set has been powered on and is set to the correct AV mode.
- Ensure that the connections between the player and the TV are secure and correct.
- Check if the connection cables are damaged.

### ***The picture is noisy or distorted.***

- Reset your TV's color system.
- If an antenna is in use, try repositioning it for better reception.

### ***There is no sound or distorted sound.***

- Ensure that the TV and amplifier have been turned on and properly set up.
- Ensure that the TV and amplifier connections are secure and correct.
- Ensure that the MUTE function of the TV, Amplifier, or Player is not engaged.

### ***The remote control doesn't work.***

- Ensure that there are no obstacles between the remote and the player.
- Point the remote at the remote sensor on the main unit.
- Ensure that the batteries in the remote retain a charge and have been installed correctly.
- Try replacing the remote's batteries.

# TROUBLESHOOTING

***The unit has malfunctioned.***

- Unplug the TV and let it rest for 30 minutes. Plug it back in, the restore function should reset the TV.

# SPECIFICATIONS

Display Type	19" TFT LCD
Display Resolution	1280 x 1024
Display Pixel Pitch	0.264mm
Display Contrast	500:1
Display Brightness	250 cd/m <sup>2</sup>
TV System	NTSC-M
TV Tuning system	FS with PLL
	VHF-L: 55.25MHZ ~ 83.25 MHZ VHF-H: 175.25 MHZ ~ 211.25 MHZ UHF: 471.25 ~ 801.25 MHZ
Power Supply	AC: 100-240V 50/60Hz
Power Consumption	Working: 35W (max) Standby: ≤1.1W
Video Input	Component Video S-Video Composite Video
Audio Input	RCA Stereo Audio
Operating Temperature	50°F - 104°F
Unit Dimensions	18.6" x 15.2" x 6.1" (WHD)
Weight	11.7lbs

# NOTES

# NOTES

**COBY Electronics Corp.**

56-65 Rust Street  
Maspeth, NY 11378

[www.cobyusa.com](http://www.cobyusa.com)  
[www.ecoby.com](http://www.ecoby.com)