

BEKO

INTEGRATED DIGITAL HD READY COLOUR TELEVISIONS

40WLU530HID



HD
ready



Operating Instructions

TABLE OF CONTENTS

1.Important Information	1
1.1-Cleaning the screen and cabinet.....	1
1.2-Disposing of your TV at the end of service life... ..	1
1.3-Superior features of your integrated digital television	1
1.4-Receiving digital broadcasting channels	1
1.5-Changing the plug.....	2
2.Features of your new television	3
2.1-Special Features	3
3.Important Safety Instructions	4
4.Start.....	7
4.1-Aerial connection	7
4.2-Powering on your TV and the initial use.....	7
4.3-Batteries	7
5.Your new television	8
5.1-TV Control Panel	8
5.2-Rear and Side External Connections	8
5.3-Remote Control	9
6.Performing the initial power-on settings.....	10
6.1-TV controls	10
6.2-Turning on the TV and Setting the Channels	11
6.3-Performing Digital Tuning	11
6.4-Performing Analogue Tuning	15
7.Settings of Your New Television	18
7.1- Sound Menu Settings	18
7.2-Picture Menu Settings.....	19
7.3-Features Menu Settings	21
7.4-Other picture features	22
8.Teletext(Analogue).....	24
9.External equipment connection	26
9.1-Connection types for external devices.....	27
9.2-PC Mode	27
9.3-Connecting a video recorder device and a digital satellite receiver.....	28
10.Help and tips	29
11.Technical specifications chart.....	30
12.MAIN UK TRANSMITTER STATIONS	31
13.Guarantee and Service	32-33

1 Important Information

LCD panels are produced with state-of-the-art technology. However, there may be missing or lit spots on the screen under certain circumstances. That does not mean that the product is faulty.

1.1-Cleaning the screen and cabinet...

After powering off, wipe the screen and the cabinet clean with a soft and dry cloth. We recommend that you do not use patented polishes or solvents on the screen or cabinet since they may cause damage.

1.2-Disposing of your TV at the end of service life...

The cold cathode fluorescent lamp found in your LCD screen contains a very small amount of mercury. Once your TV reaches the end of its useful life, please dispose of it in accordance with local government regulations or leave it at a recycling centre.

1.3-Superior features of your integrated digital television

This television can receive and process all analogue and digital broadcasts. This television set has an integrated digital and analogue receiver. The digital receiver unit processes the signals coming from digital transmitters and converts them into superior sound and image quality. TV Guide (valid for digital broadcasts only) informs you about changes in the program list briefly and provides program lists of all digital broadcasts for a number of forthcoming days. You can display detailed information about each program by pressing a single button if this feature is supported by the broadcaster. This television has a comprehensive and user friendly menu configuration.

1.4-Receiving digital broadcasting channels

You will need an outdoor aerial to receive digital broadcasts. Contrary to the analogue broadcasts, all digital broadcasts may not have their own transmission frequency. Instead, various digital broadcasts channels are gathered in regional or national groups called bouquets. You can find current transmission data from teletexts of various broadcasters or from TV guide or from the internet.

Note:

- HD Signals must be connected to the HDMI or component (YPbPr) inputs. See page 8 for external connections.
- You should check your postcode to make sure that you are in a freeview coverage area.(www.freeview.co.uk)

1.5-Changing the plug

The supplied mains cable already has a mains plug fitted, however should you need to replace it at any time please refer to the appropriate wiring information below for your particular cable.

IMPORTANT

The wires in the mains lead are coloured in accordance with the following code:
Blue - Neutral
Brown - Live

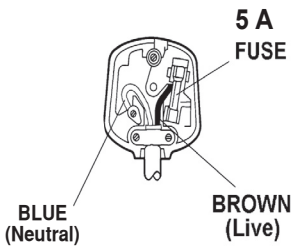

As the colours in the mains lead of this appliance may not correspond with the coloured markings identifying the terminals in your plug, proceed as follows:

The wire which is coloured blue or black must be connected to the terminal which is marked with the letter N or coloured black.

The wire which is coloured brown or red must be connected to the terminal which is marked with the letter L or coloured Red.

No connection is to be made to the Earth terminal of the plug.

If a 13 Amp (BS1363) Plug is used, fit an ASTA approved 5 A fuse

If your product is fitted with a moulded plug which requires replacement please cut off and dispose of it safely, then rewire as shown in the diagram to the left.

IMPORTANT

The wires in the mains lead are coloured in accordance with the following code:
Blue - Neutral
Brown - Live
Yellow/Green - Earth

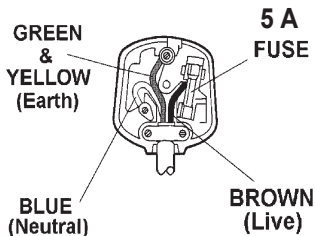

As the colours in the mains lead of this appliance may not correspond with the coloured markings identifying the terminals in your plug, proceed as follows:

The wire which is coloured green and yellow must be connected to the terminal which is marked with the letter E, or by the earth symbol, or coloured green or green and yellow.

The wire which is coloured blue or black must be connected to the terminal which is marked with the letter N or coloured Black.

The wire which is coloured brown or red must be connected to the terminal which is marked with the letter L or coloured Red.

If a 13 Amp (BS1363) Plug is used fit an ASTA approved 5 Amp fuse.

If your product is fitted with a moulded plug which requires replacement please cut off and dispose of it safely, then rewire as shown in the diagram to the left.

2 Features of your new television

Thank you for buying this television which is designed to give you many years of satisfactory service. You may already be familiar with using a television but do please take time to read these instructions. They are designed to familiarise you with the tv's many new features and to ensure you get the very best out of your purchase.

2.1-Special Features

- Compatible with cable broadcasts
- Wide angle of vision
- PIP (Picture in Picture) from AV
- Scart socket, AV Socket and external sound system connection
- S-VHS and Phono inputs for S-Video connection
- PC connection
- Low energy consumption
- AVL
- SRS TruSurround sound (*)
- Dynamic bass (*)
- Programmable power on
- Programmable power off
- 250 pages Teletext (Analogue mode)
- Fastext , Toptext (*)
- Graphic equalizer
- Sharpness feature in Color Transitions (CTI)
- Sharpness feature and picture resolution (LTI) in black-white transitions
- A clearer Picture made possible with a Digital Comb Filter
- Active Contrast (*)
- On-screen viewing of all settings, program numbers and all operations.
- Manual Fine Tuning
- 100 Analogue Program memory
- 1000 Digital channel memory
- Infrared remote control equipped with all functions
- Parental Control
- Panel Lock
- Ability to watch NTSC video playback through Scart input
- Easy performance of the processes with the advanced menu system
- 4:3, 16:9, 14:9 Letterbox(*), Subtitle(*) and Panorama(*) picture formats
- 8-day EPG (Electronic Program Guide)-Digital mode only
- MHEG 1.06
- Automatic new channel search feature
- Software upgrade by over air transmission
- List of 6 favorite channels in digital mode
- CI slot input
- HDMI connection
- HDCP feature
- HD-Ready

HDMI™ HDMI, the HDMI logo and High-Definition Multimedia Interface are trademarks or registered trademarks of HDMI Licensing LLC.

(*): These features are optional and they are not available on all models.

STAND REMOVAL

- Cover a table with a soft towel (or other protection to prevent damage to the TV or table)
 - Carefully lay the T.V. front down on the table
 - position the T.V. table stand so that it hangs over the edge of the table
 - Remove the screws that hold the stand to the T.V.
 - Remove the stand.
 - Attach any new brackets before lifting T.V. back up.
- Note: Keep removed stand and screws safely for future use.

3 Important Safety Instructions



This symbol is used to warn the user about the “dangerous voltage” contained inside the TV that may create a risk of electrical shock.



This symbol is used to remind the user important usage and service instructions supplied with the TV.

- 1) Please **READ** the operating instructions before using the TV for the first time.
- 2) Please observe the instructions contained in the Operating Instructions.
- 3) Please consider all warnings.



- 4) **MAKE SURE** that all power connections (extension cables and the connections between the external equipment) have been made properly and in accordance with the manufacturer’s instructions. Before making or changing the connections, power off the TV and unplug the mains connection plug.

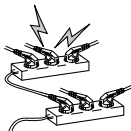

- 5) If you have any doubts regarding the installation, operation or safety of the TV, please **REFER** to the retailer.

- 6) **BE CAREFUL** with glass panels and covers on the TV. The screen glass may break and cause serious injuries if something hits it.

- 7) To ensure adequate ventilation, please leave a clearance area of at least 10 cm around the television. This clearance prevents the TV from overheating and consequently causing damage.

- Using the TV in dusty environments should also be avoided.
- Never block the slots and openings by placing the TV on a bed, sofa, pillow or other similar surfaces.

- Never install the TV into closed places such as bookcases or cabinets unless adequate ventilation is provided.

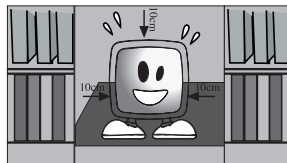

- 8) **DO NOT COVER** the ventilation openings of the TV with items such as newspapers, table-clothes, curtains, etc. Overheating causes damage and shortens the service life of the TV.



- 9) Your TV may be damaged if you place it under direct sunshine or close to a heater. Please abstain from using the TV in very hot or humid locations or in places where the temperature is likely to decrease below 5°C (41°F). **DO NOT PLACE** on or near the TV any hot objects or items with open flame such as candles or any night lamps. The high temperature can melt plastic parts and cause a fire.

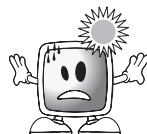

10) Never operate your TV close to water. Operating your TV, for example, near a bathtub, washbasin, wet basement and swimming pool can cause fire or electric shock.



- Do not allow your TV to get wet. Never pour any liquids onto the TV. Do not operate your TV if any solid or liquid substance enters into it. This can cause electric shock and your TV may be damaged. Have it checked immediately by qualified personnel.



- Keep open flame sources (such as candles) away from your TV in order to avoid risk of fire.



11) DO NOT USE

headphones at extremely high volume levels since this may cause permanent loss of hearing.



12) Operate your TV only in the 230 V 50Hz voltage range. Use the mains lead supplied with the TV. If your TV is a grounded (Class I) product, then it must be connected to an earthed socket.

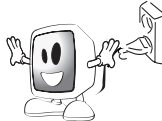

- **The socket into which you plug in the AC mains cable must be within easy reach.**
- **Unplug the your TV in order to disconnect it from the mains power.**

Note: Do not use defective sockets. Make sure that the plug is firmly inserted into the socket. If the plug remains loose, then it can cause fire due to arcing. Refer to an electrician to have your socket replaced.

13) Make sure that the mains lead is not stepped on and that there is no bending at the plug sections, plug heads and TV output point.



14) Use only the accessories specified by the manufacturer.

15) Use only, brackets or stands specified by the manufacturer or sold along with the TV. Place your TV on a level surface.

16) Unplug the mains lead cable during thunderstorms or when you will not use your TV for a long period of time.



17) Consult authorised service personnel for service requirements. Never attempt to repair the TV yourself.



Opening the cabinet can expose you to dangerous voltages or other hazardous situations. Service is required in situations such as damage to the mains lead of the TV or its plug, water spills or substances falling into the TV, the TV is subjected to rain or moisture, it does not operate normally or it is dropped.

18) Wipe the TV cabinet clean with a soft and dry cloth. Wipe dust from the screen gently with a soft cloth. Stubborn stains can be cleaned with a cloth slightly moistened with soap and lukewarm water. Never use solvents such as thinner or gasoline for cleaning. Unplug the AC mains lead from the socket when cleaning the TV. Otherwise, there is the risk of electric shock.

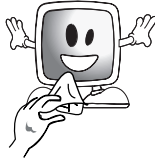

Note 1: This is a Class A product. During operation, the TV can cause radio interference. In this case the user may have to remedy this. Please contact your specialist dealer.

Note 2: Electromagnetic fields can cause temporary performance degradation. This can be distinguished as noise in the image.

19) Do not dispose of the batteries in a fire..

- Do not short circuit, dismantle or overheat the batteries. **There is the risk of explosion if the batteries are not replaced correctly. Replace only with the same or equivalent type batteries.**

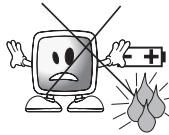

20) Disposing of the exhausted batteries:

- Dispose of the exhausted batteries in accordance with the local laws and regulations in order to protect our environment.



21) Do not dispose of your TV with regular household waste. Observe local laws and regulations for disposal.



Remove your television carefully from its box. You can keep the packaging of your television to use in future.

Items supplied with your television:

Instruction Manual

Mains lead

Remote control

2 Batteries

Note: Scart, HDMI, VGA and PHONO cables are not supplied with the device.

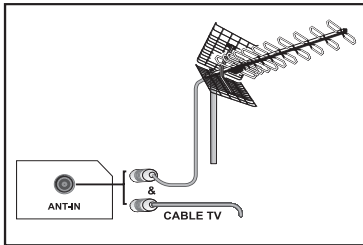

4.1-Aerial connection

If you use a 75 Ohm coaxial cable (round cable) as an aerial cable, connect the aerial plug directly to the aerial input located on the TV.

Motorized vehicles, energy lines and telecommunication lines affect your aerial. Therefore, be careful to install your aerial away from these and metal surface in such a way that it shall not move. Do not make your aerial cable longer than required and do not coil it. Make sure that it is not crimped passing through a window or door. Your aerial and cable might be affected by natural phenomena such as rain, wind, smoke and humidity over time. Periodically check your aerial and equipment.

4.2-Powering on your TV and the initial use

1. Insert the mains lead into the power supply input located on the back panel of the LCD TV.

2. Insert the mains lead plug supplied with the TV into the mains socket.

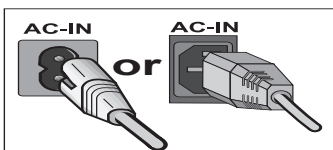

Note1:Your TV does not have a separate on/off switch, therefore to switch the power completely off (i.e. not on standby), switch off or unplug the TV at the mains socket.

STANDBY

7

PR+

PR-

Note2: Your TV is equipped to operate with TV buttons in case your R/C is broken or the batteries are exhausted.

3. Press the power on/off button located on the LCD TV.

4. To power on your television, press any numerical key or **PR+** or **PR-** keys on the remote control. For this process, you can also use the buttons on your TV. The picture will appear on the screen after a short while.

Note: If you are not going to use your television for a long time, unplug its mains lead from the socket.

Initial power on and performing settings

To set up your television, read the sections on the TV controls and making the channel settings.

4.3-Batteries

Open the lid of the battery compartment and make sure that you have placed the batteries in the correct direction. For this remote control, UM-4, IEC R03 or AAA 1.5 V batteries are suitable.

Do not throw your old batteries into the fire, discard them in a dedicated waste area for this purpose.

Do not mix used batteries with new ones or different types of batteries together.

The performance of the remote control will be reduced at a distance of 8 meters from or at an angle of 30 degrees beyond the centre of the TV.

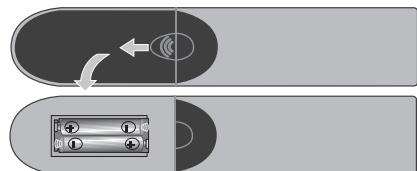

5 Your new television

5.1-TV Control Panel

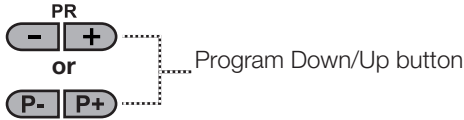

Program Down/Up button

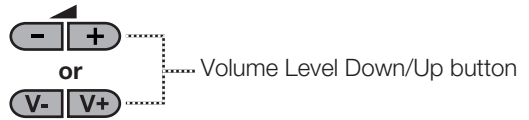

Volume Level Down/Up button



Menu button / Source selection button



On-Off / Standby button

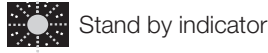

Bright light: TV is in Stand-by

Dimmed light: TV is On

No light: Power Cable is not connected.

5.2-Rear and Side External Connections

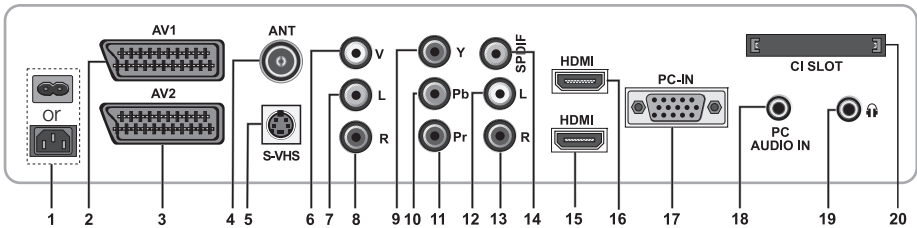

1-Power input

2-AV1 scart

3-AV2 scart

4-Aerial input

5-S-VHS input

6- Video input PHONO connector

7-Sound output PHONO connector (Left/L)

8-Sound output PHONO connector (Right/R)

9-Component video input (Y)

10-Component video input (Pb)

11-Component video input (Pr)

12-Component audio input (L)

13-Component audio input (R)

14-SPDIF Digital audio output

15-HDMI 1 input

16-HDMI 2 input

17-VGA (PC connection input)

18-PC audio input

19-Stereo Headphone socket

20-CI slot input

Note: Above drawing for external connections is representational. Their order and places on your TV may be different.

Please see Technical Specifications Table on page 30 for the available external connections on your television.



































- Please do not use the video Phono and S-Video connection simultaneously, otherwise these two devices might influence the picture quality of one another.

5.3-Remote Control



Note: In the analog mode when no menu is open on the screen, **Up/Down** movement buttons function as program forward/backward button and **Left/Right** movement buttons function as Volume up/down button.

(D) : Digital Mode Only

-  Stand-by mode On/Off button
-  Temporary sound mute (Mute) button
-  AV modes selection menu button
-  Picture Format selection button
PAT (Picture and Teletext) Mode
-  ZOOM mode selection button
-  Subtitle selection button (D)
-  Sound selection button (D)
-  Numeric buttons
-  Favorite channel selection button (D)
Page Stop button in Txt mode (Hold)
-  EPG selection button (D)
Question/Answer button in Txt mode (Reveal)
-  Information button
Index page button in Txt mode
-  MENU button
-  Exit menu button
-  Return to previous menu button
-  Up movement button (Menu)
Next page selection button in Txt mode
-  Down movement button (Menu)
Previous page selection button in Txt mode
-  Left movement button (Menu)
Change source in PIP mode button
-  Right movement button (Menu)
Change source in PIP mode button
-  Menu selection confirm
Program table selection button (D)
-  Volume down button
-  Volume up button
-  Program forward selection button
-  Program backward selection button
-  Red teletext button
MHEG display button
-  Green teletext button
-  Yellow teletext button
-  Blue teletext button
-  Teletext/Mix selection button
-  Equalizer selection button
Teletext page enlarge button (Double)
-  Picture Mode selection button
Page update button in Txt mode (Update)
-  Last viewed program selection button
Sub page button in Txt mode (Sub Page)
-  Freeze Picture button
-  Time Display button
Change PIP size button
-  Change PIP position button
-  PIP selection button

6 Performing the initial power-on settings





6.1-TV controls

6.1.1-Temporary on/off (STAND-BY)





 When you press the red **STAND-BY** button located on the upper left hand side of your remote control while your television is switched on, the sound and the picture will go off. In the stand-by mode, the power indicator of your television will glow brighter. To switch your television back on, either press any numeric button or **PR+ / PR-** buttons.

Caution! If you are not going to use your television for a long time, unplug its mains lead from the socket.



6.1.2-Channel Selection





 You may enter whichever program number you would like by pressing the **PR+ / PR-** buttons located on your television and your remote control. To select the programs that are above 9, you can use the Numerical buttons. You may enter the number of the program you would like to select using the numerical buttons. For example, to switch to the program number 12, press respectively the numeric buttons 1 and 2 on your remote control. You can perform the program selection also from the Program Table. See Page 17



6.1.3-Digital TV, Analogue TV and AV Mode Selection



 Press the **AV** button on your remote control. **SOURCE** menu will be displayed. Select **DIGITAL TV, ANALOGUE TV** or desired **AV** mode from the Source menu with **Up/Down** movement buttons and confirm with **OK** button so that your television will switch to the source you have selected.

6.1.4-Performing the Volume setting

 You can adjust the volume of your television by using the **VOL+ / VOL-** buttons on your remote control.

6.1.5-Temporary sound mute (MUTE)





 To temporarily mute the sound of your television, press the **MUTE** button on your remote control. The **MUTE** symbol will appear on the screen. When you press the same button a second time, the sound will be restored. If you press the **VOL+** button while in the Mute mode, the sound level is increased and the Mute function is aborted.

6.1.6-Returning to Selected Program (SWAP)

 Allows you to switch between the current program you watch and the last selected program. For example, if you change the channel to Program 11 while you were watching Program 1, press **SWAP** button to switch back to Program 1. Press **SWAP** button to switch back to Program 11 again.

PR 01 →  PR 11 →  PR 01

6.1.7-Main Menu

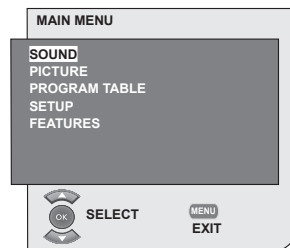

 Press the **MENU** button. The Menu including all the setting menus will appear on the screen. Navigate through the Menu titles with the **Up/Down** movement buttons and press the **OK** button to select the desired menu. If you want to exit the menu in any step, just press the **EXIT** button. Press **BACK** or **MENU** buttons to return to the previous Menu while you are in a sub menu.



6.2-Turning on the TV and Setting the Channels

When you turn on your television for the first time, **FIRST TIME INSTALLATION CHECK AERIAL CABLE IS CONNECTED. PRESS OK KEY TO CONTINUE** message is displayed.

If the aerial connections are correct, press **OK** button to continue.

COUNTRY SELECTION menu will be displayed. Select the country by using **Up/Down, Left/Right** movement buttons and press **OK** button to start the auto programming. **Channel Search** menu will be displayed and digital channels are scanned and stored in the memory.

After completion of the searching process **Channel Search Results** menu will be displayed. Number of TV and Radio channels already detected and stored in the memory at the end of the search process will be displayed in this menu. Finish the Digital channel searching process by pressing the **OK** button.

PRESS OK KEY TO START ANALOGUE SEARCH PRESS MENU KEY TO EXIT message will be displayed. You can make Analogue channel tuning with **OK** button or finish the searching process by pressing the **MENU** button.

6.3-Performing Digital Tuning

You can either tune the Digital programs automatically or manually and store them in your television.

6.3.1-Automatic Tuning of Channels and Storing in the Memory

Press **AV** button on your remote control, select **DIGITAL TV** tab from the **SOURCE** menu by using **Up/Down** movement buttons and confirm by pressing the **OK** button. Your TV will switch to Digital mode. Press **MENU** button, **MAIN MENU** will be displayed. Select **SETUP** tab with **Down** movement button and confirm with the **OK** button. **SETUP** menu will be displayed.

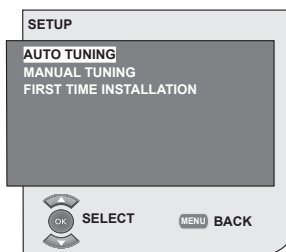

Select **AUTO TUNING** tab and confirm by pressing the **OK** button. **COUNTRY SELECTION** menu will be displayed.

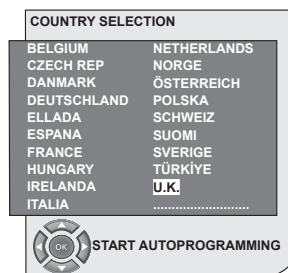

Select the country by using **Up/Down, Left/Right** movement buttons and press **OK** button to start the auto programming. **Channel Search** menu will be displayed and digital channels are scanned and stored in the memory.

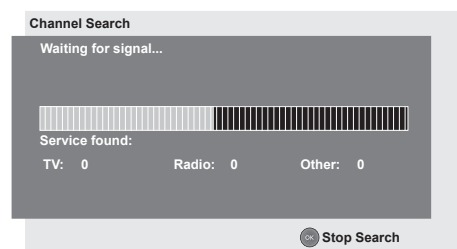

Note: You can also assess **Auto Tuning** menu from the **Service Menu** submenu under **Digital Features** menu.

6.3.2-Manual tuning of channels and storing in the memory

In digital mode: Press **MENU** button, **MAIN MENU** will be displayed. Select **SETUP** tab with **Down** movement button and confirm with the **OK** button. **SETUP** menu will be displayed. Select **MANUAL TUNING** tab and confirm by pressing the **OK** button. **Manual Search Parameters** menu will be displayed.

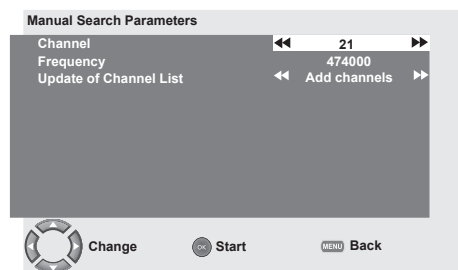

Highlight the **Channel** tab by means of **Up/Down** buttons and directly enter the frequency number of the channel you want to search, if you know, by using the numeric keys on the remote control. If you don't know the frequency number, you can scan frequencies by using the **Left/Right** movement buttons. After entering the frequency you want to search, highlight **Update of**

Channel List tab with **Up/Down** movement buttons and select either one of **Add channels**, **Replace channels** or **Erase channel list** items, then press **OK** button to start searching. Channels will be searched or changed according to the search method you have chosen.

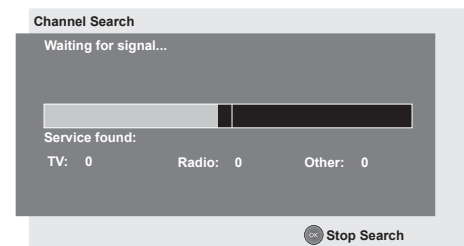

Add Channels : With this option, the new channels in the frequency which is desired to be manually searched will be scanned and added to the existing channel list.

Replace Channels : With this option, you can update the existing channel list with the modifications made by the broadcaster.

Erase Channel List : With this option, you can delete all channels in the existing channel list to store only the new channels in the desired frequency into the memory.

Note: You can also access the **Manual Tuning** menu from the **Service Menu** submenu under **Digital Features** menu.

6.3.3-Program Table

With the program table, you can see the stored channels in a list and create 6 favorite channels lists as you desire.

Select the **PROGRAM TABLE** item from the main menu by means of **Up/Down** movement buttons to access program table and press **OK** button to confirm. Program Table will be displayed. You can also access the program table menu directly by pressing the **OK** button on your remote control when there is not any open menu on the screen.

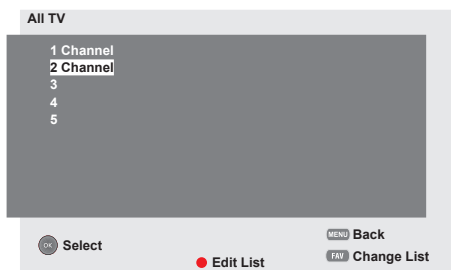

6.3.3.1-Displaying Television and Radio channel lists and selecting the channels



When the program table menu is opened, all TV and radio channels stored in the list are displayed. You can navigate between the channels with **Up/Down, Left/Right** movement buttons or you can select any channel you wish by pressing the **OK** button.

6.3.3.2-Creating favorite channels list



You can create 6 favorite channel lists according to your personal preferences. To do this press the **RED** button when you are in Program table. Favorite Lists will be displayed. All TV channels can be seen on the Left hand side and favorite channels on the Right hand side. In All TV Channels list select the channel you want to add to the favorites list by using **Up/Down** movement buttons and press **OK** button to confirm; name of the

channel you have selected will be displayed on the favorite channels list. Repeat the same steps for every channel you want to add. To create a different favorites list, you can change the favorite channels list by pressing **FAV** button on your remote control and add channels to these lists as described above. To select directly the favorite channels lists you have created, you can use the **FAV** button on your remote control.

Note: You can also access the **Favourite Lists** menu from the scroll down menu of **Digital Features** menu.

6.3.4-Electronic TV Guide (EPG)

If it is supported by the broadcaster, the electronic TV guide gives information about the programs of the next 8 days (for digital channels only).



To display the Electronic TV Guide, press **EPG** button on the remote control. Electronic TV Guide will be displayed.

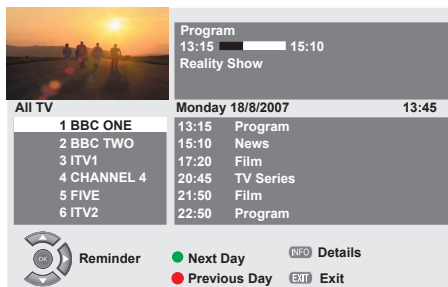

You can select the channel by using the **Up/Down** movement buttons and navigate through the program data with **Right** movement button. To get further information about the program press **INFO** button and detailed information about the selected program will be displayed. Press the **GREEN** button to display next day's program information, press the **RED** button to display previous day's program information and press **OK** button to add Reminder to any program. You can use **FAV** button on your remote control to switch between Favorites lists in the EPG menu.

Important Note: Not all broadcasters supply a detailed TV guide. Most of the broadcasters provide daily program information, but they do not give detailed explanations. Some broadcasters, on the other hand, do not give any program information at all. It may also take a short while to load the full EPG data.

6.3.5-Digital Features

To enter digital features menu, select **FEATURES** tab from the main menu by using **Up/Down** movement buttons. Select **DIGITAL FEATURES** tab from **FEATURES** menu by using **Up/Down** movement buttons and press **OK** button to confirm. **DIGITAL FEATURES** menu will be displayed.

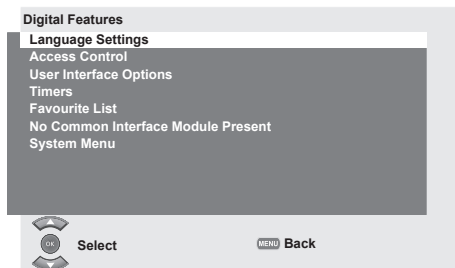

You can select the menu headings with **Up/Down** movement buttons to make settings.

6.3.5.1-Language Settings

You can select subtitle and sound language provided that the broadcast is supported for all digital broadcasting channels. Unless you make a selection, the language supported by the broadcaster will be selected automatically.



To perform language selection, select **Subtitling Language 1**, **Subtitling Language 2**, **Audio Language 1**, **Audio Language 2** tab from the **Language Settings** menu by using **Up/Down** movement buttons and make your language selection with **Left/Right** movement buttons. You can also select subtitles directly by **SUBT** button on your remote control or make sound selection by **AUDIO**

button.

6.3.5.2-Access Control

With this feature you can lock channels that are not appropriate for children and set age restriction for programs being broadcasted.

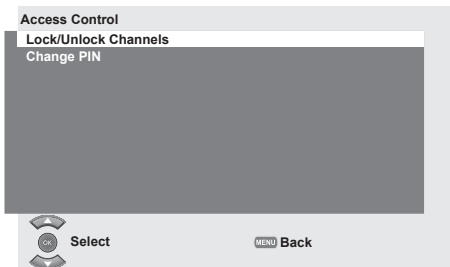

Lock/Unlock Channels: Select **Lock/Unlock Channels** tabs from **Access Control** menu and press **OK** button to confirm. All TV Channels list will be displayed; select the channel you want to lock with **Up/Down** movement buttons and press **OK** button to confirm. **x** mark will be displayed at the beginning of the channel name which is to be locked. To unlock, repeat the same steps. Select the channel which is locked and enter the correct password into the displayed password screen. The channel will not be displayed unless the correct password is entered.

Note1: To re-prevent access after entering the correct password and displaying the locked channel, your television has to be switched to Standby mode and turned on again.

Note2: The password for both of these features has been set as **0000** at the factory. You can change the password as you wish under **Change PIN** item in the **Access Control** menu.

6.3.5.3-User Interface Options

From this menu, you can decide whether to display the scrambled channels in the program table or not. If this option is set to **ON**, all channels will be displayed. If it is set to **OFF**, scrambled channels will not be displayed. If it is set to **AUTO** and a CI card is installed to your television, then the scrambled channels supported by the card will be displayed.

6.3.5.4-Timers

In this menu you can view Reminders you had entered from the EPG or change the entered Reminders.

6.3.5.5-Favourite Lists

Please see 6.3.3.2-Creating favorite channel list for detailed explanation of this feature.

6.3.5.6-Common Interface Module

To receive subscription channels you will need to purchase a conditional access module (CAM) and card. When no cam is fitted the display will show "No Common Interface module present." However with a cam fitted the display will indicate "top up tv".

In this menu, you can check the CI Module settings.

6.3.5.7-System Menu

You can display your television's hardware and software data under this menu.

6.4-Performing Analogue Tuning

You can either tune the Analogue channels automatically or manually and store them in your television.

6.4.1-Automatic tuning of channels and storing in the memory

Note: If your television does not receive any aerial broadcast for a period of 5 minutes, it automatically switches to the stand-by position. The countdown OSD is displayed on the screen during the last 1 minute (applicable for Analogue mode only)

You can tune the programs automatically with the Autoprogram function of your television and then sort the channels as you desire by means of the Program Table. Press **AV** button on your remote control, select **ANALOGUE TV** tab from the **SOURCE** menu by using **Up/Down** movement buttons and confirm by pressing the **OK** button. Your TV will switch to

Analogue mode. Press the **MENU** button on your remote control. Select **SETUP** tab with **Down** movement button and confirm with **OK** button. Setup menu is displayed. Select **PROGRAM NO** tab by pressing the **Up/Down** movement buttons in Setup menu, enter the channel number to be searched and stored automatically, then select **AUTOPROGRAM** tab by using the **Up/Down** movement buttons and press **OK** button; Country Selection menu will be displayed.

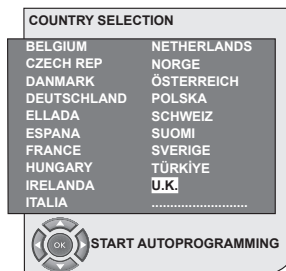

In the Country Selection menu, select the UK option, by pressing the **right/left** movement buttons and start autoprogramming by pressing the **OK** button. The channels will be automatically searched and those found will be stored in memory starting from the program selected in the Setup menu. At the same moment, the Autoprogram menu will be displayed and a marker indicating the progress of the autoprogramming will appear as shown below.

To stop the process at any given time, please press the **MENU** button. The



Program Table, which will allow you to sort the channels as you wish, will be displayed after the automatic search is complete.

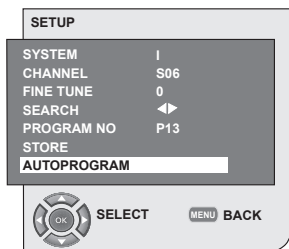

6.4.2-Manual tuning of channels and storing in the memory

6.4.2.1-If you already know the channel number (See page 31)

Press the **MENU** button. Move to the **SETUP** menu by pressing the **Down** movement button in the Main Menu and

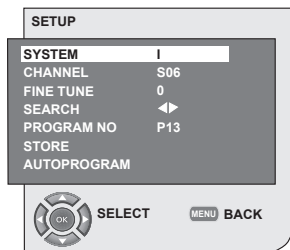

confirm your selection with the **OK** button. Setup menu will be displayed. Select system I (for UK use) from the **SYSTEM** tab. Move into **CHANNEL** tab by pressing the **Down** movement button. Press **OK** on your remote control to select “S” for cable channels and “C” for channels received via the aerial. Move onto the **PROGRAM NO** tab and using the number buttons

enter the channel number in which you would like to have the channel stored. If the broadcast viewed on the screen is of your desired quality, first move onto the **STORE** tab with the down movement button to store in the memory the selection you have made and store the channel by pressing the **Left** or **Right** movement buttons. The prompt **STORED** will be displayed briefly. The channel will be stored according to the program number of your choice. You can tune and store in memory other channels the same way. In the event that you wish to exit the channel settings menu for any reason, simply press the **EXIT** button.

6.4.2.2-If you do not know the channel number

Press the **MENU** button. Move to the **SETUP** menu by pressing the **Down** movement button in the Main Menu and confirm your selection with the **OK** button. Setup menu will be displayed. Select the system in which you would like to make the search from the **SYSTEM** tab. Move into **CHANNEL** tab by pressing the **Down** movement button. Press **OK** on your remote control to select “S” for cable channels and “C” for channels received via the aerial.

Select **SEARCH** tab using the **Up/Down** movement buttons, and scan the channels in ascending order with **Right** movement button and in descending order with **Left** movement button. If the channel that is found is of your liking, select the **STORE** tab. Then store it in the memory by pressing the **Right** or **Left** movement buttons. Repeat the same procedure for other channels by selecting the program number of your choice from the **PROGRAM NO** tab. If the channel you found is not of the desired quality and requires Fine Tuning or if you would like to rename the channel, refer to the relevant sections.

6.4.3-Fine Tuning

If the channel you found is not of the desired quality and requires Fine Tuning, then select the **FINE TUNE** tab by pressing the **Down** movement button in the Setup menu. Using the **Left/Right** movement buttons on your remote control, adjust the broadcast displayed on the screen to your desired quality. Under normal circumstances, you will not require to use the Fine Tune function. The AFC values of your television will automatically adjust and lock themselves to the channel. However, you might need it in case the television transmitters do not operate according to the standards. To store in the memory the settings you have made, select the **Store** tab and press the **Right** or **Left** movement button.

6.4.4-Program Table

Press the **MENU** button. Move to the **PROGRAM TABLE** tab by pressing the **Down** movement button in Main Menu and confirm your selection with the **OK** button. Program Table menu will be displayed.

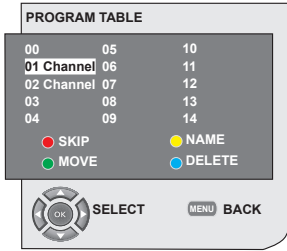

6.4.4.1-Switching the locations of the stored channels

Select the program you would like to relocate by pressing the **Up/Down** or **Left/Right** movement buttons. "Press the **"GREEN"** button. Green will blink. Move to the other program you would like to relocate by pressing the **up/down** or **right/left** movement buttons. "Finish the relocation process by pressing the **"GREEN"** button. The channel in the first program number you selected has been moved to your second selected

program number and the channels between both program numbers have been shifted to the initially selected program number. After setting is complete, press the **EXIT** button to exit the menu.

6.4.4.2-Deleting a stored channel

Select the program you would like to delete by pressing the **up/down** or **right/left** movement buttons. "Press the **"BLUE"** button. The blue button on the menu will blink for approval. "You may

perform the deletion process by pressing the **"BLUE"** button or you may abort the deletion process by pressing the **MENU** button. "Once you press the **"BLUE"** button, the selected program is deleted and the following channels are transferred to

after this program number. After setting is complete, press the **EXIT** button to exit the menu.

6.4.4.3-Skipping a stored channel

In the event that you do not wish to see certain programs while navigating through the channels using the **PR+/PR-** buttons, then you can use this function. Select the program that will be hidden by pressing the **up/down** or **right/left** movement buttons. "Press the **"RED"** button. The name of the program to be skipped shall appear in red. You may perform this procedure for more than one program. To view the skipped program, directly enter the program number using the numeric buttons. To cancel the program skipping process, press again the **"RED"** button. After setting is complete, press the **EXIT** button to exit the menu.

6.4.4.4-To name the channels

You can assign your program or programs of choice the names that have a maximum of five characters. Select the program you would like to name from the Program Table by pressing the **up/down** or **right/left** movement buttons. "Press the **"YELLOW"** button. An empty space appears beside the channel for which you would like to specify name information. Here, choose the desired letter, number or sign using the **up/down** movement buttons. For the second character, press the **right** movement button and then select the desired letter, number or sign again with the **up/down** movement buttons. After entering all the characters, store the name you have written in the memory by pressing the **"YELLOW"** button. To write names for any of the other programs, simply repeat the above procedure. If you want to exit the menu, simply press the **EXIT** button. If the program is not named, then the channel number of that program will be displayed automatically.

7 Settings of Your New Television

7.1- Sound Menu Settings

 You may perform volume settings by using the **VOL+** or **VOL-** buttons on your television or the **VOL+ /VOL-** buttons on your remote control. You can perform other Sound settings by entering the Sound menu. For this, press the **MENU** button on your remote control. Select **SOUND** by pressing the **Up/Down** movement buttons from the main menu and press the **OK** button. The Sound menu is displayed.

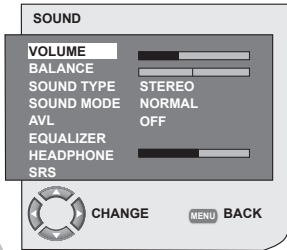

 You can select the tab which you want to process with the **Down** movement button and set its level with **Left/Right** movement buttons.

7.1.1-Balance

To adjust the sound balance between the right and left loudspeakers to the desired level, select the **BALANCE** tab in the sound menu by using the **Down** movement button. Using the **Left/Right** movement buttons adjust this option to the desired level.

7.1.2-Sound type

The program you watch may be broadcast in stereo or in two different languages. Using the **Right/Left** movement buttons in this menu, you can select Mono/Stereo or Dual-I/Dual-II languages.

7.1.3-Sound Mode

Sound mode can be set as **NORMAL**, **SPATIAL** or **SRS** by means of direction buttons. Spatial option gives depth to the

sound of the program. Options in the SRS menu become active when the SRS function is selected.

Note: SRS menu will not be active if the SRS is not selected from the Sound mode tab.

7.1.4-AVL (Automatic Volume Limiting)

Television transmitters have different sound levels. This can be noticed as high and low volume levels in different channels while switching from one program to another. Using the **Left/Right** movement buttons, select **ON**. The AVL (Automatic Volume Limiting) function maintains the same sound level as you switch from program to program. Select **OFF** to cancel it.

7.1.5-Headphones

By connecting headphones to your television you can listen to the program sounds independently from your television. To turn up and down the headphone volume level, select **HEADPHONE** tab from the Sound menu and adjust the volume level by using the **Left/Right** movement buttons. When you want to hear the sound from the headphone only, just press the **MUTE** button on your remote control.

7.1.6-SRS TruSurround Sound

This is the virtual sound technology. With TruSurround, 6 different channels of the digital sound are processed in two channels and conveyed to the audience through two speakers. TruSurround system is used to create a virtual surround sound effect in environments where there is no 4.1 or 5.1 speaker systems exist.

 **TruSurround is a registered trademark of the SRS Labs. Inc.**

TruSurround XT technology is covered under the license of SRS Labs. Inc.

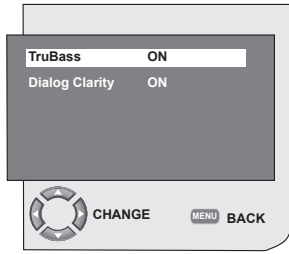

7.1.6.1-TruBass

TruBass system is a signal processing technology that reinforces the bass sounds.

7.1.6.2-Dialog Clarity

This feature enhances the understandability of speech dialog.

Note: When the **SRS** is set to On, **AVL** and **EQUALIZER** functions will automatically be set to Off.

7.1.7-Equalizer

Select the **EQUALIZER** tab in the Sound menu and confirm with the **OK** button. The Equalizer menu is displayed. Using the **Left/Right, Up/Down** movement buttons, you may select either one of the preset **MUSIC, SPORTS, CINEMA** and **SPEECH** options which enhance the sound effect depending on the feature of the program you are watching or the **USER** option which you can adjust as you desire. To adjust the User option, select **USER** and press the Right movement button. You can adjust the frequency levels with the Up/Down movement buttons. You can select one of the **120Hz, 500Hz, 1.5KHz, 5KHz** and **10KHz** frequency bands with **Right** and **Left** movement buttons. Press the **MENU** button to store the settings and exit the user option. You may exit the equalizer menu by pressing the **MENU** button again.

Note: You can select the equalizer options directly by pressing the (J) button on your remote control.

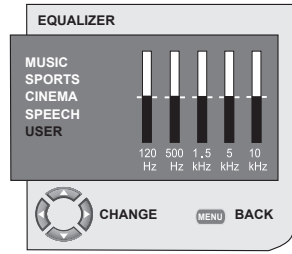

7.1.8-Dynamic Bass (optional)

Dynamic Bass, makes the bass content of the music clearer throughout the volume level range. When the volume is set to a lower level, bass frequencies at the lower end generally disappears. Dynamic Bass feature, that reinforces the bass levels can be used to avoid this.

7.2-Picture Menu Settings

7.2.1-Picture Menu

You can perform other picture settings by entering the Picture menu. For this, press the **MENU** button on your remote control. Select **PICTURE** by pressing the **Up/Down** movement buttons from the main menu and press the **OK** button. The Picture menu will be displayed.

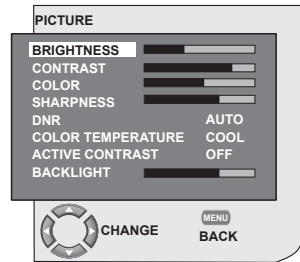

You can select the desired setting by pressing the **Up/Down** movement buttons and adjust their levels with **Right/Left** movement buttons. You can adjust **BRIGHTNESS, CONTRAST, COLOR** and **SHARPNESS** levels as you desire. The changes you have made in the picture settings will be stored in the memory without requiring any other operations.

7.2.2-DNR (Noise reduction) (Optional)

You may reduce interference and noise formed in the picture by using this feature. Select **DNR** tab in the Picture menu with the **Up/Down** movement buttons to activate this feature and select one of the **OFF, LOW, MID, HIGH** or **AUTO** options with **Left/Right** movement buttons.

7.2.3-Color Temperature

You can adjust the color temperature with this feature. Move to the Color Temperature tab in the Picture menu by pressing the **up/down** movement buttons and select **WARM, COOL** or **NORMAL** by pressing the **right/left** movement buttons.

7.2.4-Tint

When **NTSC** video is input via Scart, you may make Hue settings. The tint option is not seen in the menu when you have not input this type of a video. When a **NTSC** video is connected via the Scart, this option becomes active and it is available in the menu.

7.2.5-Active Contrast (Optional)

This feature allows making brightness settings according to the picture. A brighter or dimmer picture can be sent to the screen according to the brightness level of the picture. Thus, a wider effect is obtained in terms of contrast.

7.2.6-Backlight

With this feature, you can adjust the intensity of light reflected to the LCD Panel. Select **Backlight** by pressing the **Up/Down** movement buttons and adjust the desired level by pressing the **right/left** movement buttons.

Note: If your TV is equipped with Active Contrast feature and this feature is set to On, then Backlight tab is not displayed in the menu.

7.2.7-MPEG NR (Optional)

You may remove the artifacts that appear in the picture as square shaped blocks by using this feature except in the Tuner mode. Select Mpeg NR tab from the Picture menu with the Up/

Down movement buttons to activate this feature and select one of the **OFF, LOW, MID** or **HIGH** options with **Right/Left** movement buttons.

Note: MPEG NR feature appears in the menu for all sources except the Tuner mode.

7.2.8-Picture Smart



You can select either one of the three non-adjustable settings in the memory or one of the user options by pressing the “()” button on your remote control. **SOFT, NATURAL, RICH** are default values; **USER** represents the values you stored in memory.

7.2.9-Picture Format



With this option, you can view the broadcast you watch in a format of your choice. You may view broadcastings in either **AUTO, 16:9, 14:9, 4:3, LETTERBOX, SUBTITLE** or **PANORAMA** formats. **16:9, 14:9** or **4:3** formats can be selected in **PC** modes. In that case, the name of the selected picture format will be displayed in the centre of the screen.

Note: In PC Mode, 4:3, 16:9 and 14:9 picture formats are supported in 16:9 panels. Only 4:3 picture format is supported in 4:3 panels.

7.2.9.1-Auto

Some movie channels may broadcast in the 16:9 format. If you would like to see this format automatically, then select **AUTO**. In that case, **AUTO 16:9** appears on your screen.



7.2.9.2-16:9

Please use this setting for watching wide screen DVDs, wide screen video cassette or 16:9 formatted broadcasts. Since various screen formats such as 16:9, 14:9 and etc. are used, black stripes might be formed on the lower and upper parts of the screen.



7.2.9.3-14:9

This is a movie format.



7.2.9.4-4:3

Use this setting to watch the broadcasts in the 4:3 format.



7.2.9.5-Letterbox (Optional)

While watching a "16:9 or Cinemascope formatted" film or video cassette, this setting will eliminate or minimize the black stripes on the background by zooming in the picture without diffusing it.



7.2.9.6-Subtitle (Optional)

If the subtitles are transmitted in the "16:9 formatted" broadcast, then this setting will push the picture upwards in order to ensure the entire written text to be seen.



7.2.9.7-Panorama (Optional)

This setting will enlarge the image to fit the screen by stretching the image horizontally while holding the correct proportions at the centre of the image. Some distortion may occur.



Note: Since the use of certain functions in order to change the picture sizes for collective projection or commercial purposes (modifying the height and width etc.) will be deemed an infringement of the picture's copyright, legal proceedings can be carried out as required under relevant laws.

7.3-Features Menu Settings

Press the **MENU** button on your remote control. Select **FEATURES** by pressing the **Up/Down** movement buttons from the main menu and press the **OK** button. The Features menu will be displayed. You can select the titles for which you would like to perform an operation in Features menu by using the **Up/Down** movement buttons.

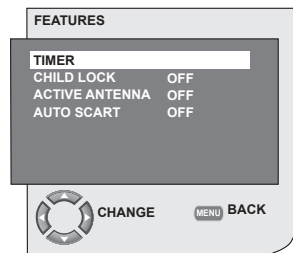

7.3.1-Timer

Your television can be turned off and on at periods that you specify. Select **TIMER** by pressing the **Up/Down** movement buttons and press the **OK** button in order to have your TV turned off at the end of a desired period. The Timer menu will be displayed.

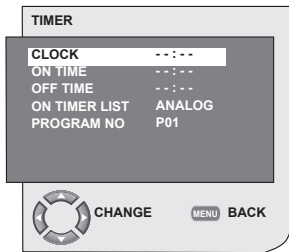

Time data is obtained from Teletext; if no time data is available then select **TIME** with the **up/down** movement buttons and enter the current time with numeric buttons. Select the **ON TIME** and **OFF TIME** for television in the same manner and specify the time. From the **ON TIMER LIST** item, select your TV's on mode at the end of the set time. Enter the program number you desire with the numeric buttons or the external source with the **AV** button into **PROGRAM NO** tab to specify the channel or source from which you would like the TV to be turned-on to. At the end of the time you specified, your television will automatically switch to stand-by. If the on time for TV is specified in the Menu, the TV will switch to the selected program or to the external source at that time; if the TV is in standby mode, then it will be turned on with the selected channel or external source.

7.3.2-Child Lock (Analogue Only)

If this feature is turned On, the program currently being watched becomes locked, the image and sound goes off and the locked symbol appears on the upper left corner of the screen. The locked channel is skipped when you channel search with **PR+**, **PR-** buttons.

Note: Child lock feature is for Analogue mode only. Child lock tab does not appear in the menu in Digital mode.

7.3.3-Auto Scart

When this feature is set to On and when you operate an external device that is connected to your LCD television via scart, TV will automatically switch to AV mode where the device is connected. When it is set to Off, your TV does not switch to the external device automatically.

7.3.4-Active Antenna

When using a portable aerial requiring a power source, if this feature is set to on, you

can eliminate the need for a power source. For best results it is recommended to use an outdoor aerial.

7.4-Other picture features

7.4.1-Zoom



Press the **ZOOM** button on your remote control while watching a channel to activate this feature. During the zooming process, the image is zoomed in in three stages oriented to the centre. To move the picture in this mode, you can use **up/down** or **right/left** movement buttons of your remote control. **Note:** Zoom mode does not function with COMP/HDMI/PC inputs. Zoom mode is aborted when the channel is changed or Teletext is activated.

7.4.2-Freeze (Freeze picture)



You may freeze the program picture you are watching with this feature. For this, press the **FREEZE** button on your remote control. The program picture will freeze until the same button is pressed a second time.

7.4.3-Using PIP Feature (Picture in Picture) (*)

Press the **PIP** button on your remote control. PIP screen is displayed. Depending on the selected source, a window will be opened in the main picture and a sub screen will be displayed. You can switch to PAP mode by pressing the **PIP** button again. You can return to the TV mode by pressing the **PIP** button when you are in the PAP (Picture and Picture) mode. **You can use Right/Left buttons to change the source in the PIP screen when you are in the PIP or PAP mode. You can use Up/Down buttons to change the channels.**

Note 1: Two different channels from the Tuner can not be viewed in the PIP screen. Only the broadcast from the external source can be viewed in the PIP screen.

Note 2: Since the external sources such as satellite receivers focus on single channel and transmit it to the TV although they can receive many channels, other channels that are received by similar devices can not be displayed on the POP screen.

Note 3: HDMI2 can not be selected in the PIP screen when HDMI1 is displayed on the main screen.

Note 4: Right and left movement buttons do not control the volume in PIP, PAP and PAT modes. They can only be used to change the source.

7.4.3.1-PIP Position

With this option, you can change the display position of the PIP screen. You can change the position of the PIP screen in clockwise by pressing the **Pos** button when there is a PIP picture on the screen.

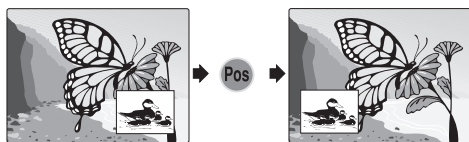

7.4.3.2-PIP Size

With this option, you can increase and decrease the size of the PIP window. You can change the PIP size by pressing the **Size** button when there is a PIP picture on the screen.

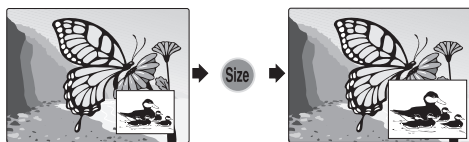

7.4.3.3-Switching the locations of the Main screen and PIP screen

When a sub window is open in front of the main window, you can switch the locations of the main window and sub window by pressing the **SWAP** button on your remote control.

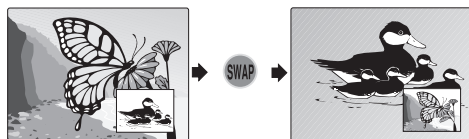

7.4.4-PAT Mode

TXT With this feature, you can follow the teletext broadcasts simultaneously with the current program, provided that the current program contains teletext broadcast. For this purpose, when you press **TXT** and then **16:9** buttons in a channel with teletext broadcasting, the screen will be split into two with the left pane showing the currently watched program and the right pane will show the Teletext at the same time. In the event that you wish to exit the PAT mode for any reason, simply press the **16:9** button.

8 Teletext (Analogue)

Teletext means in short the transmission of various updated information along with the TV broadcast signal in the form of text and graphics. To be able to receive a quality teletext broadcast, a good aerial system and a broadcast signal that is not weak, with no reflections and interference from other channels are required. Even in a very clear reception, it is normal for some characters or tabs to be lost. Such conditions will automatically be improved in a short time under normal circumstances.

8.1-Entering the Teletext Mode

 In a channel that does not have the Teletext feature, “**NO TEXT**” will be displayed when you press the **TXT** button. In order to switch your television to the teletext broadcast, please press the **TXT** button in a program that has a teletext broadcast. To switch back to the television broadcast, press the same button twice. Once you have switched to the teletext broadcast, the initial page that appears will be the index page. **P100** In this page, the titles of the topics in the teletext broadcast and the initial page numbers will appear.

8.2-Page Selection

 To be able to view the page you would like on the screen, type in the number of that page using the numerical keys. You can see the number you have entered on the left side of the upper title tab. When you would like to turn the pages one by one, you can go to the next page pressing the **up** button and to the previous page pressing the **down** button. Press the **INFO** button to return to the Index page.

8.3-Teletext image in the TV picture (MIX)

 With this feature, you can watch the teletext information and the TV broadcast together. Thus, you can follow the teletext broadcast of the channel while you watch the TV broadcast. To do this, press **TXT** button in a channel with Teletext broadcast.

8.4-Page enlarge button (DOUBLE)

 Using this button, you can watch the top half of the teletext page in an enlarged format. To be able to view the bottom half of the enlarged page, press the same button for the second time. Once you press the same button the third time, the page will be restored to its normal size.

8.5-Page Stop (HOLD)

 Some information is laid out by the broadcasting agency in multiple pages and it is broadcast in an automatic cycle mode. For example, on a text of four pages, the pages are indicated with the figures 01, 02, 03 and 04 on the bottom of the page. To view one of these pages for a longer time, press the **FAV** button. When you press the same button again, the cycle continues.

8.6-Subpage selection (SUB)

 If the page of text you are viewing contains sub pages the page numbers starting from 01 appear on the screen. You can switch to the sub pages with the **SWAP** button. In that case, the sub page tab is displayed on the bottom line within “Red -” and “Green +” frames. “You can select the sub pages by pressing the “**RED**” and “**GREEN**” buttons. You can exit the subpage by pressing the **SWAP** button

again.

8.7-Temporary TV Picture (UPDATE)



This button allows you to switch to the television picture while the page you want is being searched in the teletext broadcast eliminating the need to wait during the search. You may switch to the television picture by pressing the () button while Teletext is searching for your desired page. Once the page you want is found, the number of that page appears on the screen.

8.8-Question - Answer Button (REVEAL)



Sometimes, a teletext page contains a hidden answer such as a game or a riddle. Press the **EPG** button to disclose the hidden answer.

8.9-Clock



The Clock function of the **SIZE** button; press the **SIZE** button when you want to learn the time while watching any television channel. In that case, a clock will appear on the lower right corner of the screen. You can remove the time information from the screen by pressing the same button.

8.10-Fasttext

The colored buttons on the remote control are for the fasttext feature. When you select any page, the titles on various subjects may appear on the screen in four different colors or inside colored frames (red, green, yellow and blue). By pressing the button pertaining to the relevant color on the remote control, you can access the subject of your choice without waiting.

Note: The fasttext feature is not available for all teletext broadcasts. It is determined by the broadcaster whether it is to be broadcast or not.

8.11-Toptext (optional)

There is a topics line in yellow and blue at the bottom of the teletext screen. You can select the relevant topic by pressing the yellow or blue buttons on the remote control. You can select the next page by pressing the red button and the previous page by pressing the green button.

Note: Fasttext and Toptext features are not available from every program.

9 External equipment connection

You can connect various compatible audio and video devices to your television.

AV inputs: Press the **AV** button on your remote control. The Source menu, where you can select the access mode will be displayed. Here, you can select whichever input you would like.

ANALOGUE TV: While in the AV or Digital TV modes, move onto this option and press **OK** button for switching to the ANALOGUE TV mode.

DIGITAL TV: While in the AV or Analogue TV modes, move onto this option and press **OK** button for switching to the DIGITAL TV mode.

SCART 1: To watch the picture of the broadcast device connected to Scart1, move onto this option and press the **OK** button. (You can watch via this Scart if the connected device has a RGB output).

SCART2: To watch the picture of the broadcast device connected to Scart2, move onto this option and press the **OK** button.

SCART 2S: To watch the picture from the SCART2 input in Y/C format, move onto this option and press the **OK** button.

AV: To watch the picture of the broadcast device connected using the RCA (PHONO) input, move onto this option and press the **OK** button.

S-VIDEO : To watch the picture of the broadcast device connected using the S-Video input, move onto this option and press the **OK** button.

PC: To be able to watch the images in PC mode, move onto this option and press the **OK** button.

HDMI 1: To be able to watch the image when a connection is made via the HDMI 1 socket, this option must be selected.

HDMI 2: To be able to watch the image when a connection is made via the HDMI 2 socket, this option must be selected.

YPBPBR (Component Input): To be able to watch the image when a connection is made via this socket, this option must be selected.

Headphone Connection

The headphones must have impedance between 8 and 32 ohms and have a 3.5 mm stereo jack plug. Plug the headphone jack into the headphone socket of the TV.

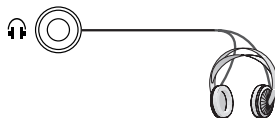

High Definition - HD ready



Your television can receive high-definition signals (HDTV). You can connect the input sources (HDTV set-top box or HDTV DVD player) to the (HDMI) socket (digital HDTV signal). This ensures that you can view digital HDTV programs, even if they are copy-protected (HDCP High-Definition Copy Protection).

9.1-Connection types for external devices

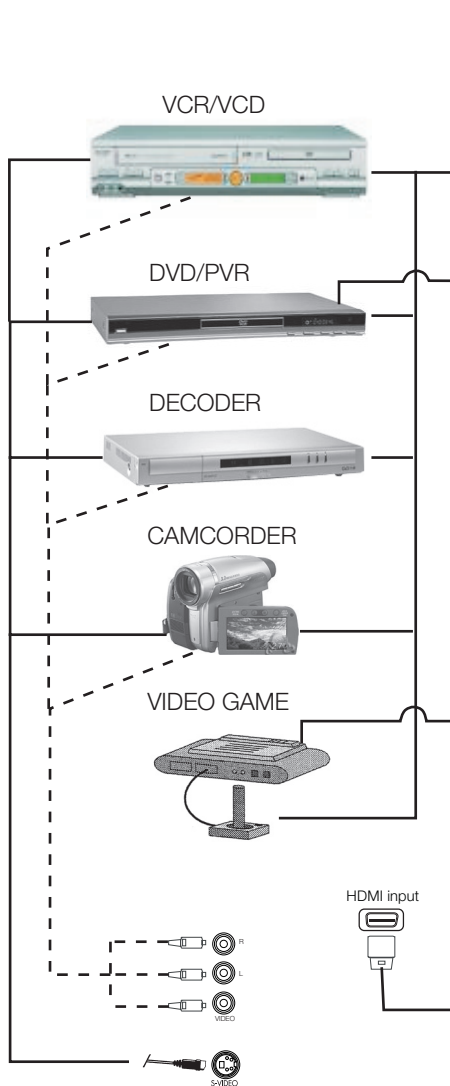

SCART SOCKET



Your TV is equipped with 10 inputs including aerial input, which allows for the external device connection. These inputs are:

- 1-Aerial input
- 2-SCART 1 input
- 3-SCART 2 input
- 4-SCART 2S input
- 5-AV (PHONO) input
- 6-S VIDEO input
- 7-PC input
- 8-HDMI 1 input
- 9-HDMI 2 input
- 10-YUV Component input

You can connect your external device supporting the suitable inputs to your TV via these inputs. By pressing the **AV** button on your remote control, select the external source input to which you connected your device.

9.2-PC Mode

Your LCD television can also be used as a PC monitor via the VGA input.

9.2.1-PC Connection:

Connect the D-Sub15 connector to the PC-IN input on the rear of your television using a suitable cable (not supplied with the television). Again using a suitable cable, you can also listen to the sound from your PC by connecting the sound output of your PC to the PC AUDIO-IN input on the rear of your television.

9.2.2-Switching to the PC mode

For your LCD-TV to switch to the monitor (PC) mode, press the **AV** button on your remote control. The AV menu appears on the screen. Select **PC** by pressing the **up/down** movement buttons and press the **OK** button.

Note 1: In HDMI mode; some resolutions are supported when a DVI to HDMI converter cable from a PC is used.

Note 2: In some graphic cards, when a connection is made between the TV and PC with a DVI to HDMI cable, the led will continue to light as long as the PC is open even if the TV is turned off.

9.2.3-PC Setting

Enter into the **SETUP** menu from the Main Menu by pressing the **MENU** button in the PC mode. In order to make the necessary settings in this menu, you can use the **right-left, up-down** movement buttons on your remote control. You can make the following settings for your monitor in this menu.

9.2.4-HORIZONTAL POSITION:

Horizontal position setting

9.2.5-VERTICAL POSITION: Vertical position setting

9.2.6-CLOCK

This is the pixel clock frequency. User can narrow down or enlarge the display by selecting a desired value.

9.2.7-PHASE

Using the **right/left** movement buttons, you can ensure that the colors and shapes are exactly consolidated on the PC image.

9.2.8-AUTOCONFIGURATION

The most suitable geometric settings in accordance with the input signal are configured by this function. For this operation, select the **AUTOCONFIGURATION** tab and press **OK** button. You can adjust the volume level of the source you have connected to the Audio-In input at the back of your TV by using the **VOL+/VOL-** buttons.

9.2.9-PICTURE FORMAT

You can select the PC image to be displayed in 16:9, 14:9 or 4:3 formats.

Note 1: 4:3, 16:9 and 14:9 picture formats are supported in 16:9 panels. Only 4:3 picture format is supported in 4:3 panels.

Note 2: In the Monitor mode, you can make the Brightness, Contrast, Sharpness, Red, Green and Blue Settings from the **PICTURE** menu.

Switching to the HDMI mode

Connect to the HDMI input at the back of your TV by using the connector located on your PC or your digital video-transmission device with a suitable cable (not supplied with the TV).

Note 1: To be able to watch an image in the HDMI mode, your computer must be equipped with a HDMI graphic card.

You may display the resolution information by pressing the **INFO** button.

Note 2: Scart1 To connect a RGB-supported external device to your television, you must use a Scart cable supporting RGB. In this case, if your external device supports, you can set the output as RGB.

HDCP (Optional)

Your TV supports HDCP feature. To use this feature, you must set up a connection to your TV set's HDMI video port and select HDMI by pressing the **AV** key on your remote control.

9.3-Connecting a video recorder device and a digital satellite receiver

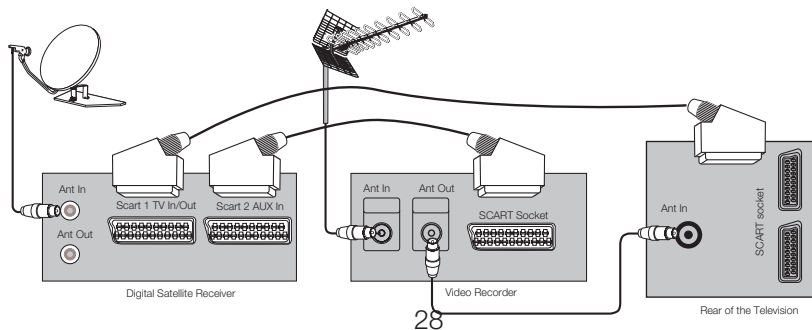

10 Help and tips

Failure	Possible cause	Solution
The television does not function	Is the mains lead connected to the mains supply and the TV?	Check the mains lead
	Is the main power socket switched on?	Check if the On/Off switch is on.
Poor picture quality	Is the aerial cable attached?	Check the aerial cable.
	If you are using a satellite dish, is it well adjusted?	Have the dish adjusted.
	Aerial may be affected by connected external devices.	Try disconnecting one of the devices.
	It may need fine tuning.	Perform fine tuning.
Shadow and reflection in the picture.	Picture settings are not correct.	Adjust Brightness, Contrast and Color.
	Channel setting	Perform automatic, manual channel setting or fine tuning.
No picture	Aerial	Check aerial cable and system
	Is there any damage on the aerial cable?	Check the aerial cable.
No color.	Are you sure you pressed the correct button on your remote control?	Press PR+ or PR- button to turn on the TV.
	Color intensity level is at the lowest setting.	Increase the color.
	Broadcast system setting (if setting choice is available)	Select the correct broadcast system.
No or defective teletext	Problem in channel broadcasting.	Test with another channel.
	Television channel (no teletext) or aerial system.	Test another channel for fine tuning and shadowy pictures
No sound	Very weak signal	Check the aerial system.
	Temporary sound mute may be on	Try pressing the mute button
Remote control does not work	Is the sound turned down?	Turn on the volume with Vol + button.
	Are the batteries correctly placed?	Place the batteries correctly.
	Are batteries exhausted?	Replace the batteries with new ones.
Picture is not readable after turning on the TV	Is there any obstacle between the remote control and television?	If yes, remove it.
	Child lock is active.	Disable the child lock.

If your television does not work properly even though you tried the above mentioned solutions, try turning it on and off again. If you cannot start your television even though you have applied all noted methods, refer to the dealer or authorised service from where you purchased the product. Never attempt to repair a faulty device yourself.

11 Technical specifications chart

SCREEN SIZE	40"
Panel type	40", 16:9 Active matrix TFT
Sound output	2 x 10 W
Power consumption	240 W
Stand by power value	<2,5 W
Teletext page	250
Loudspeaker impedance:	16 Ohm
Scart 1	STD
Scart 2	STD
Audio/Video PHONO (Input)	STD
S-Video socket	STD
YUV (Video/Sound) Component Input	STD
HDMI 1	STD
HDMI 2	STD
VGA Input	STD
PC Audio Input	STD
SPDIF Digital sound output	STD
Headphone socket	STD

STD: Standard

General technical specifications

Power supply AC:

230V 50 Hz

Program memory Digital:

1000

Program memory Analogue:

100

RF Aerial input:

75 Ohm (Co-axial)

Sound systems:

Mono/Stereo/Nicam

Batteries:

2xUM - 4, IEC R03 or AAA 1.5V

Channels received:

VHF (Band I Channel 2-4)

VHF (Band III Channel 5-12)

UHF (Channel 21-69)

Cable TV (S1-S20/S21-S41)

Broadcasting systems received:

PAL BG

PAL SECAM BG

PAL SECAM BG DK

PAL SECAM BG LL'

PAL I

Note: Your television has been manufactured in accordance with the system available in your country and this system cannot be changed by the user except as described below: In countries where BG/DK and BG/LL' broadcasts are made (BG or DK / BG and LL'). For further information, see the settings section for your television.

MAIN UK TRANSMITTER STATIONS

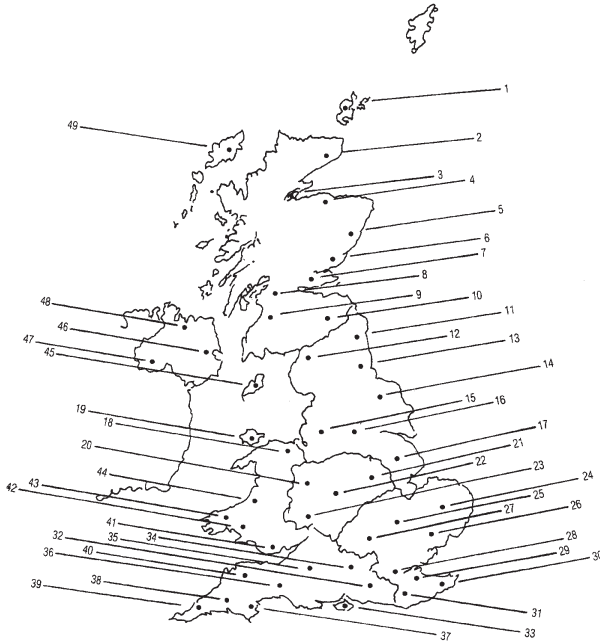

Regional Main stations	UHF CHANNELS					Map		STATIONS CT D				
	BBC1	BBC2	ITV	CH4	CH5			BBC1	BBC2	ITV	CH4	CH5
North West												
Caldbeck	30	34	28	32	56	12	Bluebell Hill	40	46	43	65	29
Winter Hill	55	62	59	65	48	15	Crystal Palace	26	33	23	30	37
Douglas (IOM)	68	66	48	56	56	45	Dover	50	56	66	53	30
North							Oxford	49	52	64	67	31
Belmont	22	28	25	32	56	17	East					
Emley Moor	44	51	47	41	37	16	Sandy Heath	31	27	24	21	39
North East							Sudbury	51	44	41	47	35
Bilsdale West Moor	33	26	29	23	35	14	Tacolneston	62	55	59	65	52
Chalton	39	45	49	42	11	11	Scotland					
Pontop Pike	58	64	61	54	56/58	13	Angus	57	63	60	53	37
Midlands (West)							Black Hill	40	46	43	50	37
Ridge Hill	22	28	25	32	35	23	Cragkelly	31	27	24	21	48
Sutton Coldfield	46	40	43	50	37	22	Darvel	33	26	23	29	35
The Wreclin	26	33	23	29	25	20	Durris	22	28	25	32	67
Mindlands (East)							Eitshal (Lewis)	33	26	23	29	49
Waltham	58	64	61	54	35	21	Keelyang Hill	40	46	43	50	1
South West							Knock More	33	26	23	29	4
Beacon Hill	57	63	60	53	37	37	Rosemarkie	39	45	49	42	3
Caradon Hill	22	28	25	32	38	38	Runnister Forest	31	27	24	21	2
Huntshaw Cross	55	62	59	65	67	40	Selkirk	55	62	59	65	52
Redruth	51	44	41	47	37	39	Wales					
Stockland Hill	33	26	23	29	36	36	Blaenplwyf	31	27	24	21	56
Channel Islands							Carmel	57	63	60	53	42
Fremont Point	51	44	41	47			Uanddona	57	63	60	53	19
West							Moel-y-Parc	52	45	49	42	18
Mendip	58	64	61	54	37	35	Presely	46	40	43	50	37
South							Wernwpa	44	51	41	47	41
Hannington	39	45	42	66	35	34	N.IRELAND					
Midhurst	61	55	58	68	32	32	Brougher Mountain	22	28	25	32	37
Rowbridge	31	24	27	21	33	33	Divis	31	27	24	21	31
							Limavady	55	62	59	65	48

13 Guarantee - Television

Your new television is guaranteed against the cost of breakdown repairs for twelve months from the date of the original purchase.

What is covered?

- All repairs necessary as a result of faulty materials, defective components or manufacturing defect.
- The cost of all functional replacement parts, excluding remote control batteries
- The labour costs of a Beko approved repairer to carry out the repair
- You may be offered a replacement instead of repair under guarantee.

Your dealer will advise you.

What is not covered?

- Transit or delivery damage
- Accidental damage
- Misuse, or abuse.
- Cabinet or appearance parts, including knobs and flaps
- Remote control batteries.
- Repairs or replacements required as a result of unauthorised repairs or inexperienced installation that fails to meet the requirements contained in the user instruction book.
- Repairs or replacements to product installed or used on commercial or non-household premises.

Important notes.

- The product is guaranteed for domestic household use only.
- The guarantee will be void if the product is installed or used in commercial or non-household premises.
- The product must be correctly installed and operated in accordance with the instructions contained within the Operating Instructions Booklet provided with the product.
- The guarantee is given only within the boundaries of the United Kingdom and the Republic of Ireland.
- The guarantee is not transferable if the product is resold.
- Beko Plc disclaims any liability for incidental or consequential damages.
- The guarantee does not in anyway diminish your statutory or legal rights.

Beko House, Caxton Way, Watford, Herts, WD18 8UF, Tel: 0845 600 4911

Website: www.beko.co.uk



HOW TO OBTAIN SERVICE

Congratulations on your choice of a Beko colour television. Your new television has been designed and manufactured to the highest quality standards to give you many years of use. To get the best out of it, please take a few moments to read the instruction book.

Your television is supplied with a full 12 months guarantee, covering parts and labour. Should you require service under guarantee, simply call the number below (**see note for small screen sets)

0845 600 4911

Our service receptionist will ask you for your product model number, your retailer's name, and the date of purchase when you call. It will assist you if you complete the box at the bottom of this page when you take delivery of your television so that the information is readily available should you need it. If it is necessary for an engineer to visit your home he will normally be there within 48hrs of receipt of your call (excluding Bank Holidays) or at your earliest convenience.

Before telephoning for service please check the trouble shooting guide in the instruction book as often minor problems are easily identified and resolved by following the instructions contained there in. Service visits where there is no fault with the product could incur a charge even though the product is under guarantee.

Service is also available on the above number after the guarantee period has expired. The cost of any repairs outside of the guarantee period is payable to the engineer at the time of visit.

Please complete the box below for ease of reference later.

Model Number	Serial Number
Date of Purchase	Place of Purchase
Please keep your purchase receipt. The engineer will need to see it should you require service under the 12-month Guarantee.	

*****Special Note:**

In home repair service is not available on models with a screen size of 21" or under. You should contact your retailer for advice and assistance on these models..

