



JE4208

42" LCD TV User's Guide

- Please observe all safety precautions when using this product.
- Please read this manual carefully before using this product.

CONTENTS

Safety Precautions

- Power Supply 3
- Installation 4
- Use and Maintenance 5
- Important Safety Instructions 6-8

User Guidance Information

- Names of each part(Front View) / Accessories 9
- Names of each part(Back View) 10
- Mounting on a Desktop / Installation Precautions 11
- Installing an Antenna 12
- Remote control 13-14
- Precautions / How to use remote control 15

Connection

- VCR Connections / Watching Video Tape 16
- Satellite/Cable TV Set-Top Box Connections / Watching Cable TV 17
- DVD Connections / Playing the DVD 18
- PC Connections / How to use as PC 19

Basic Use

- Powering the LCD TV / Selecting input source 20
- Watching TV 21

Application

- Operating the Menu 22
- Setting up the DTV(ATSC) function 23-26
- Customizing the PICTURE Settings 27
- Customizing the SOUND Settings 28
- Customizing the FUNCTION Settings 29-31
- Customizing the TV Settings 32-33
- Customizing the PC Settings 34
- Customizing the ADVANCED Settings 35

Maintenance and Service

- Trouble shooting 36
- Specifications 37
- LCD-TV Wall mounting assembly instruction 38-39

Safety Precautions

Power Supply

Warnings

Do not touch the power plug with wet hands.

- Doing so may result in electric shock.

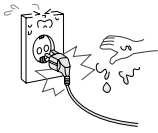

Do not use a damaged power cord or plug or a loose outlet.

- Doing so may result in fire or electric shock.

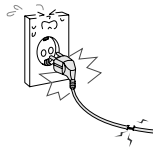

Do not plug several devices into the same outlet.

- Doing so may cause the outlet to overheat and start a fire.

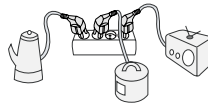

Insert the power plug fully into the outlet.

- A loose or improperly inserted power plug may result in fire.



Do not bend the power cord excessively or place heavy objects on it.

- Doing so may result in fire or electric shock.

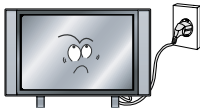

Be sure to ground the unit.

- Failing to do so may lead to electric shock when a short circuit or overload occurs. If necessary, install a ground fault circuit breaker. Never ground to a telephone line, lightning rod, or metal gas pipe. (Doing so may result in fire, electric shock, or other hazards.)

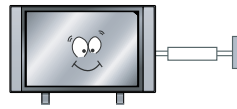

Cautions

When disconnecting the power cord from an AC outlet, always grasp it by the plug.

- Pulling on the cord can damage the internal wire and may result in fire.

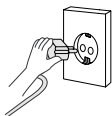

Always unplug the unit before cleaning.

- Not doing so may result in fire or electric shock.



The purpose of these precautions is to ensure user safety and prevent property damage.

Be sure to read and observe all safety precautions.



Installation

Warnings

Do not place containers with liquids such as flower vases, soft drink cans, or medicine bottles or small metallic objects on top of the unit.

- If liquid enters the unit or any metal object falls into the unit, it may result in short-circuit, fire, or electric shock.



Do not place the unit where it is exposed to rain, excessive moisture or grease.

- Doing so may result in fire, electric shock, malfunction, or deformation.

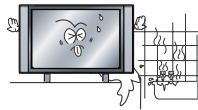

Do not use or store flammable or combustible materials near the unit.

- Doing so may result in fire or explosion.



Do not place the unit on an unstable surface, such as a wobbly stand or sloped table, or on any surface whose area is smaller than the bottom area of the unit.

- If a child climbs on the unit, it could topple and fall onto the child, resulting in serious injury to the child or damage to the unit. Place the unit on a flat stable surface.



Do not place a burning candle, burning anti-mosquito incense, or lighted cigarette on top of the unit. Do not place the unit near any heat source such as a fireplace or space heater.

- Doing so poses a serious risk of fire.

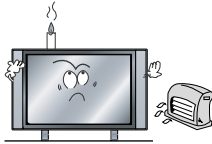

Do not place the unit in a poorly ventilated enclosure, such as a cabinet.

- Doing so poses a serious risk of fire.

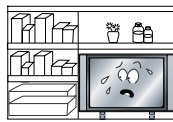

Do not run power cords near heat-producing appliances such as radiators, stoves, or irons.

- The excessive heat could melt the insulation and expose live wires, resulting in fire or electric shock.



Install the antenna away from high-voltage power lines and communication cables and make sure it is installed securely.

- If the antenna touches a power line, contact with the antenna could result in fire, electric shock, serious injury, or death.

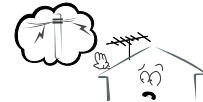

Cautions

Install the unit at an adequate distance from the wall to ensure sufficient ventilation.

- If the temperature inside the unit rises, it may result in fire.

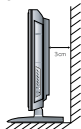

Do not cover the unit with a tablecloth, curtain, or other material.

- If the temperature inside the unit rises, it may result in fire.

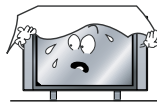

Be sure to place the unit on a level surface.



⚠ Warnings

Form a drip loop where the coaxial antenna cable enters your building to prevent rainwater from traveling along the cable and coming in contact with the antenna input terminal.

- If rainwater finds its way inside the unit, it may result in fire or electric shock.

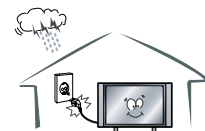

- The following precautions are divided into "Warnings" and "Cautions".

⚠ Warning : Ignoring this precaution may result in death or serious injury.

⚠ Caution : Ignoring this precaution may result in injury or property damage.

Safety Precautions

Use and Maintenance

Warnings

Disconnect the power cord from the wall outlet during an electrical storm.

- Not doing so may result in fire or electric shock.



Do not insert any metal objects, such as a screwdriver, paper clip, or bent wire into the ventilation openings or A/V terminals.

- Doing so poses a serious risk of fire or electric shock.

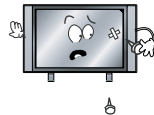

Do not allow children to climb or hang on the unit.

- The unit could topple over onto a child and result in serious injury.

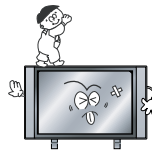

Never disassemble or modify the unit in any way. Do not attempt to service the unit yourself.

- Doing so may result in fire or electric shock. If the unit requires repair, contact the service center.

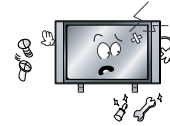

Cautions

When not using the unit for long periods of time, disconnect the power cord from the wall outlet.

- Dust could accumulate over time on the unit and cause it to generate heat and ignite, or deteriorate insulation, which in turn may result in an electrical fire.

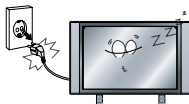

When moving the unit, be sure to turn off the unit and unplug the power cord from the wall outlet.

- Moving the unit with the power cord connected to the outlet may cause damage to the cord, resulting in fire or electric shock.

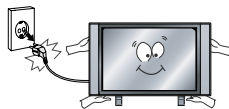

If you notice any unusual odors or smoke around the unit, immediately disconnect the unit from the outlet and contact the service center.

- Failure to do so may result in fire or electric shock.



⚠ Warnings

When removing the batteries from the remote control, make sure children do not swallow them. Keep the batteries out of the reach of infants and children.

- If a child has swallowed a battery, seek medical attention immediately.



Always use two or more people to lift or move the unit.

- If the unit is dropped, it could be damaged or otherwise cause injury.



Wipe off any moisture, dirt, or dust on the power plug pins with a clean dry cloth.

- Failure to do so may result in fire or electric shock.



It is advisable to clean the interior of the unit at least once a year. Contact the store of purchase or service center for information.

- Continuing to use the unit without cleaning off the dust build-up inside it may result in fire or electric shock.

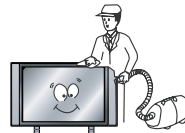

Always turn off the unit and unplug the power cord when cleaning the unit. Use a soft dry cloth to clean the unit.

- Never clean with industrial strength polish, wax, benzene, paint thinner, air freshener, lubricant, detergent, or other such chemicals. Also, do not clean with a damp cloth.

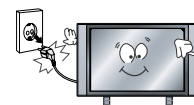

NOTE: These pictures involved in the "Safety Precautions" section are just for your reference, please take real object as standard.

Important Safety Instructions

Warnings and Precautions

To prevent any injuries, the following safety precautions should be observed in the installation, use, servicing and maintenance of this equipment.

Before operating this equipment, please read this manual completely, and keep it nearby for future reference.





- 1) Read these instructions.
- 2) Keep these instructions.
- 3) Heed all warnings.
- 4) Follow all instructions.
- 5) Do not use this apparatus near water.
- 6) Clean only with a dry cloth.
- 7) Do not block any of the ventilation openings. Install in accordance with the manufacturer's instructions.
- 8) Do not install near any heat sources such as radiators, heat registers, stoves, or other apparatus (including amplifiers) that produce heat.
- 9) Do not defeat the safety purpose of the polarized or grounding type plug. A polarized plug has two blades with one wider than the other. A grounding type plug has two blades and a third grounding prong. The wide blade or the third prong is provided for your safety. When the provided plug does not fit into your outlet, consult an electrician for replacement of the obsolete outlet.
- 10) Protect the power cord from being walked on or pinched particularly at plugs, convenience receptacles, and the point where they exit from the apparatus.
- 11) Only use the attachments/accessories specified by the manufacturer.
- 12) Use only with a cart, stand, tripod, bracket, or table specified by the manufacturer, or sold with the apparatus. When a cart is used, use caution when moving the cart/apparatus

combination to avoid injury from tip-over.



Important Safety Instructions

- 13) Unplug this apparatus during lightning storms or when unused for long periods of time.
 - 14) Refer all servicing to qualified service personnel. Servicing is required when the apparatus has been damaged in any way, such as power supply cord or plug is damaged, liquid has been spilled or objects have fallen into the apparatus, the apparatus has been exposed to rain or moisture, does not operate normally, or has been dropped.
- Apparatus shall not be exposed to dripping or splashing and no objects filled with liquids, such as vases, shall be placed on the apparatus

| | |
|---|--|
|    |  <p>The lightning flash with an arrowhead symbol, within an equilateral triangle is intended to alert the user to the presence of uninsulated "dangerous voltage" within the product's enclosure that may be of sufficient magnitude to constitute a risk of electric shock to persons.</p> |
| <p>CAUTION: TO REDUCE THE RISK OF ELECTRIC SHOCK, DO NOT REMOVE COVER (OR BACK), NO USER-SERVICEABLE PARTS INSIDE. REFER SERVICING TO QUALIFIED SERVICE PERSONNEL.</p> |  <p>The exclamation point within an equilateral triangle is intended to alert the user to the presence of important operating and maintenance (servicing) instructions in the literature accompanying the appliance.</p> |
| | 5B-En |

NOTE TO CABLE/TV INSTALLER :

This reminder is provided to call the CATV system installer's attention to Article 820-40 of the National Electric Code (U.S.A.). The code provides guidelines for proper grounding and, in particular, specifies that the cable ground shall be connected to the grounding system of the building, as close to the point of the cable entry as practical.

Apparatus with Class I construction shall be connected to a Mains socket outlet with a protective earthing connection.

Important Safety Instructions

WARNING

TO PREVENT DAMAGE WHICH MAY RESULT IN FIRE OR ELECTRIC SHOCK HAZARD, DO NOT EXPOSE THIS APPLIANCE TO RAIN OR MOISTURE.

Caution :

- These servicing instructions are for use by qualified service personnel only.
To reduce the risk of electric shock, do not perform any servicing other than that contained in the operating instructions unless you are qualified to do so.
- Any changes or modifications not expressly approved by the party responsible for compliance could void the user's authority to operate the equipment.

Important :

One Federal Court has held that unauthorized recording of copyrighted TV programs is an infringement of U.S. copyright laws.
Certain Canadian programs may also be copyrighted and any unauthorized recording in whole or in part may be in violation of these rights.

REGULATORY INFORMATION :

This equipment has been tested and found to comply with the limits for a Class B digital device, pursuant to Part 15 of the FCC Rules. These limits are designed to provide reasonable protection against harmful interference when the equipment is operated in a residential installation. This equipment generates, uses and can radiate radio frequency energy and, if not installed and used in accordance with the instruction manual, may cause harmful interference to radio communications. However, there is no guarantee that interference will not occur in a particular installation. If this equipment does cause harmful interference to radio or television reception, which can be determined by turning the equipment off and on, the user is encouraged to try to correct the interference by one or more of the following measures:

- Reorient or relocate the receiving antenna.
- Increase the separation between the equipment and receiver.
- Connect the equipment into an outlet on a circuit different from that to which the receiver is connected.
- Consult the dealer or an experienced radio/TV technician for help.

Names of each part

Front View

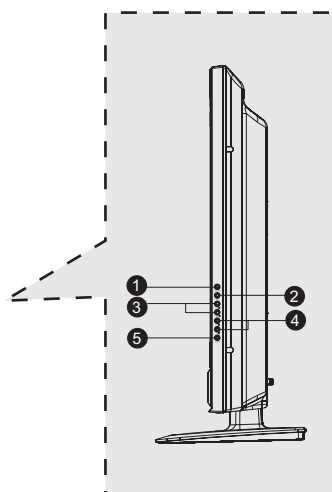
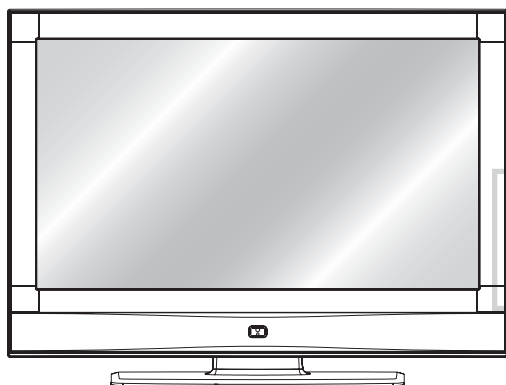

- | | |
|--|--------------------------------|
| ❶ Source Button - Input Source Select Button | ❷ Channel/Program + , - Button |
| ❸ Menu Button - OSD Menu Display Button | ❹ Power Button |
| ❹ Volume + , - Button | |

Accessories

- The configuration of the components may look different from the following illustration.



AV Cable



Battery 1.5V(AAA x2)



Power Cord

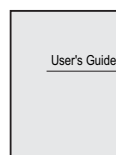

User's Guide



Remote Control

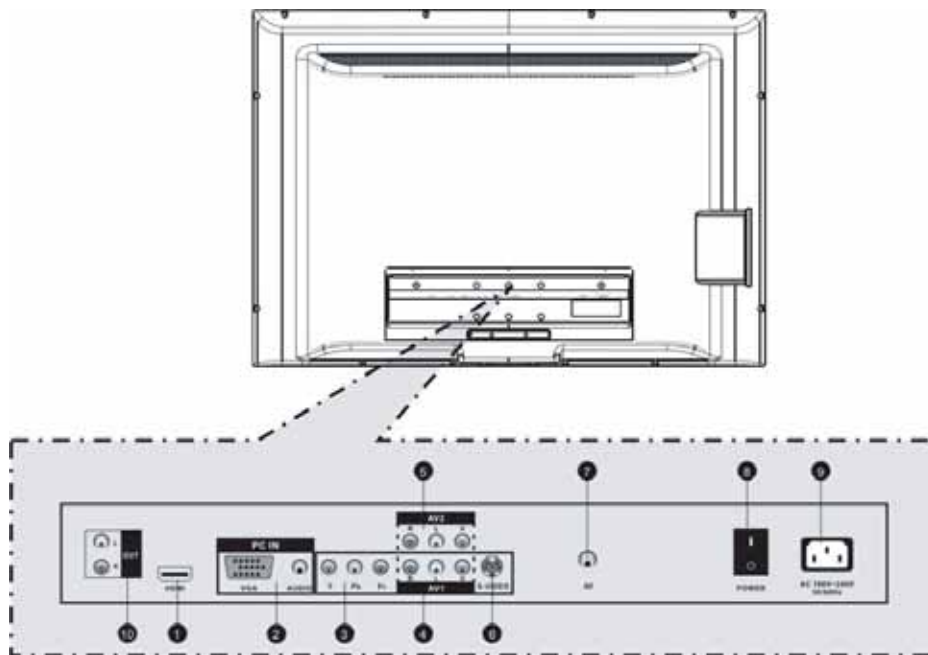

Names of each part

Back View



- | | | |
|---------------------|----------------------------------|---------------------------|
| ① HDMI jack | ④ AV1 AUDIO(L/R) and VIDEO jacks | ⑦ RF jack |
| ② PC and AUDIO jack | ⑤ AV2 AUDIO(L/R) and VIDEO jacks | ⑧ POWER ON/ OFF jack |
| ③ Y, Pb, Pr jack | ⑥ S - VIDEO jack | ⑨ AC input jack |
| | | ⑩ AUDIO(L/R) output jacks |

- To turn on the LCD TV

Press  on the back of the LCD TV to  first.

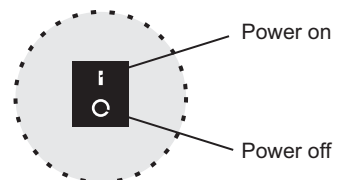

- Be sure to turn off the power and unplug both units from the wall outlet before making any connections.

Mounting on a Desktop

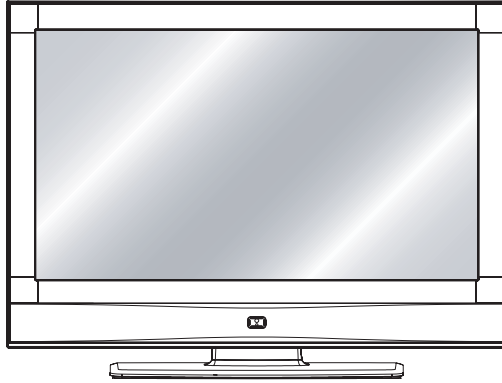

- Your LCD TV can be mounted on a Desktop as shown in the figure above.
- This is not floor-standing unit.

Installation Precautions

Wall Mounting

- Please secure enough space for safe use. (Please refer to A and B.)
- Installation of the LCD TV in an improperly ventilated location can cause a fire or damage to the LCD TV due to increased temperature.

A →
(Mounting on a wall)

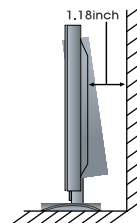
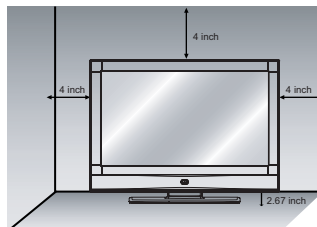

※ Contact your dealer to purchase the "Adjustable-angle wall mount" required for wall-mounted installation.

Using the Stand

- Do not install on an unstable location with support area smaller than the LCD TV.
- Please refer to the desktop stand user's manual for details of installation.

B →
(Using the Stand)

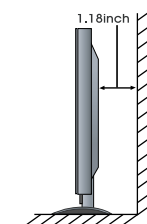
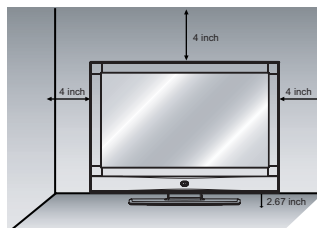

Installing an Antenna

- For connecting to ATSC or NTSC broadcasts

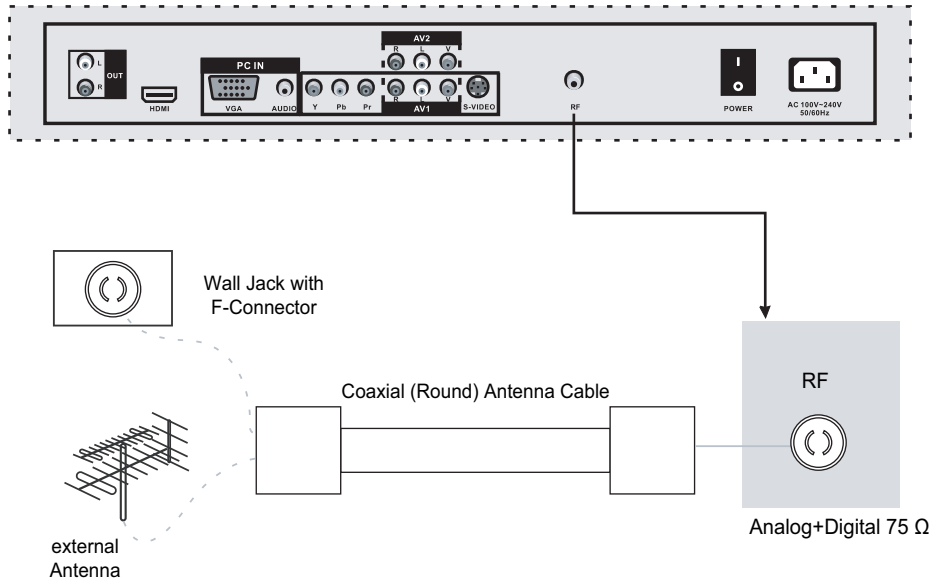

Press SOURCE button on the remote control to select TV, then press RIGHT button to confirm. Then you can receive the ATSC/NTSC signal.

Remote Control

● Functions of remote control buttons

The remote control is using Infra-Red (IR). Point it towards the front of the LCD TV. The remote control may not work correctly if it is operated out of range or out of angle.

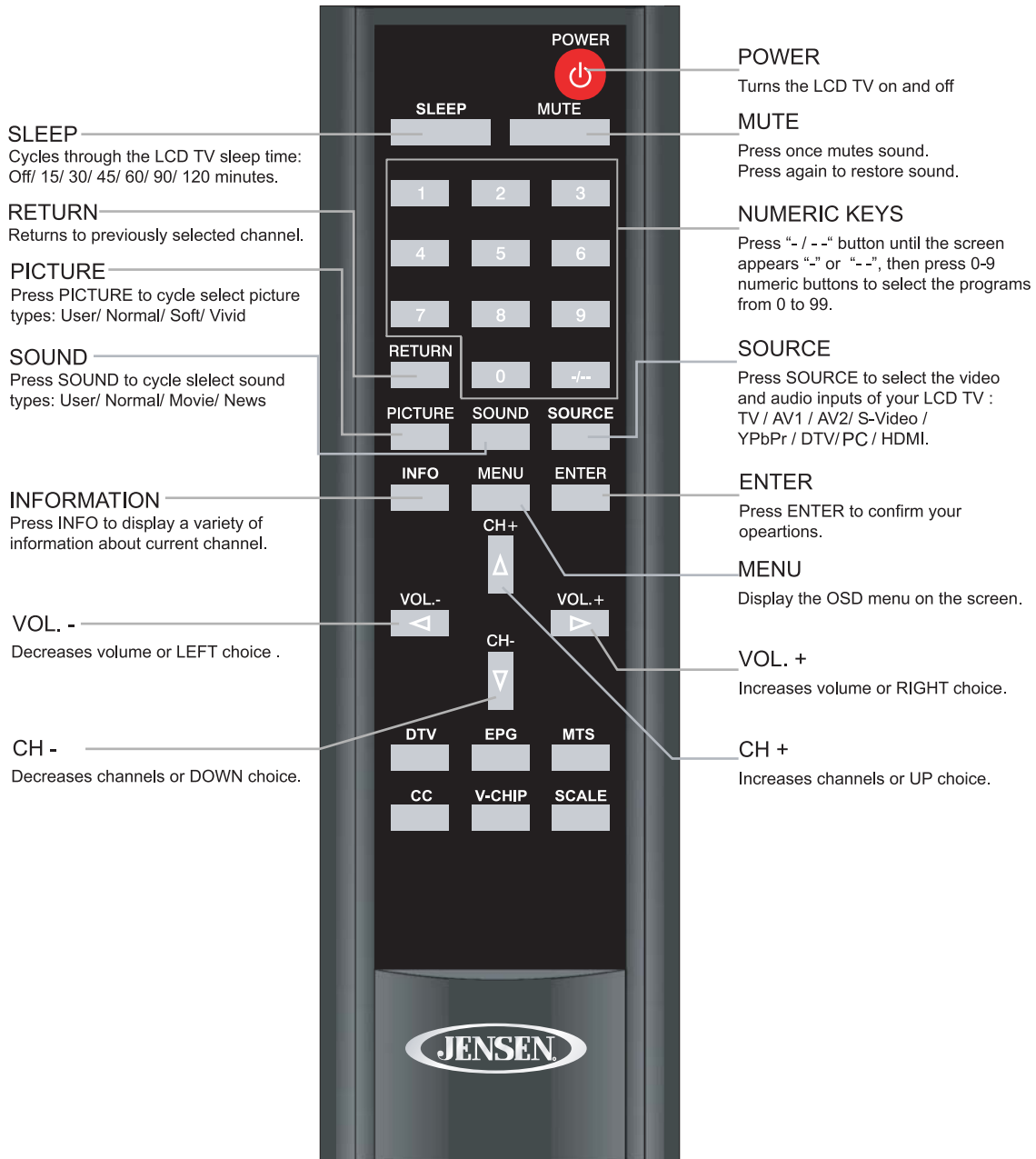

Remote Control

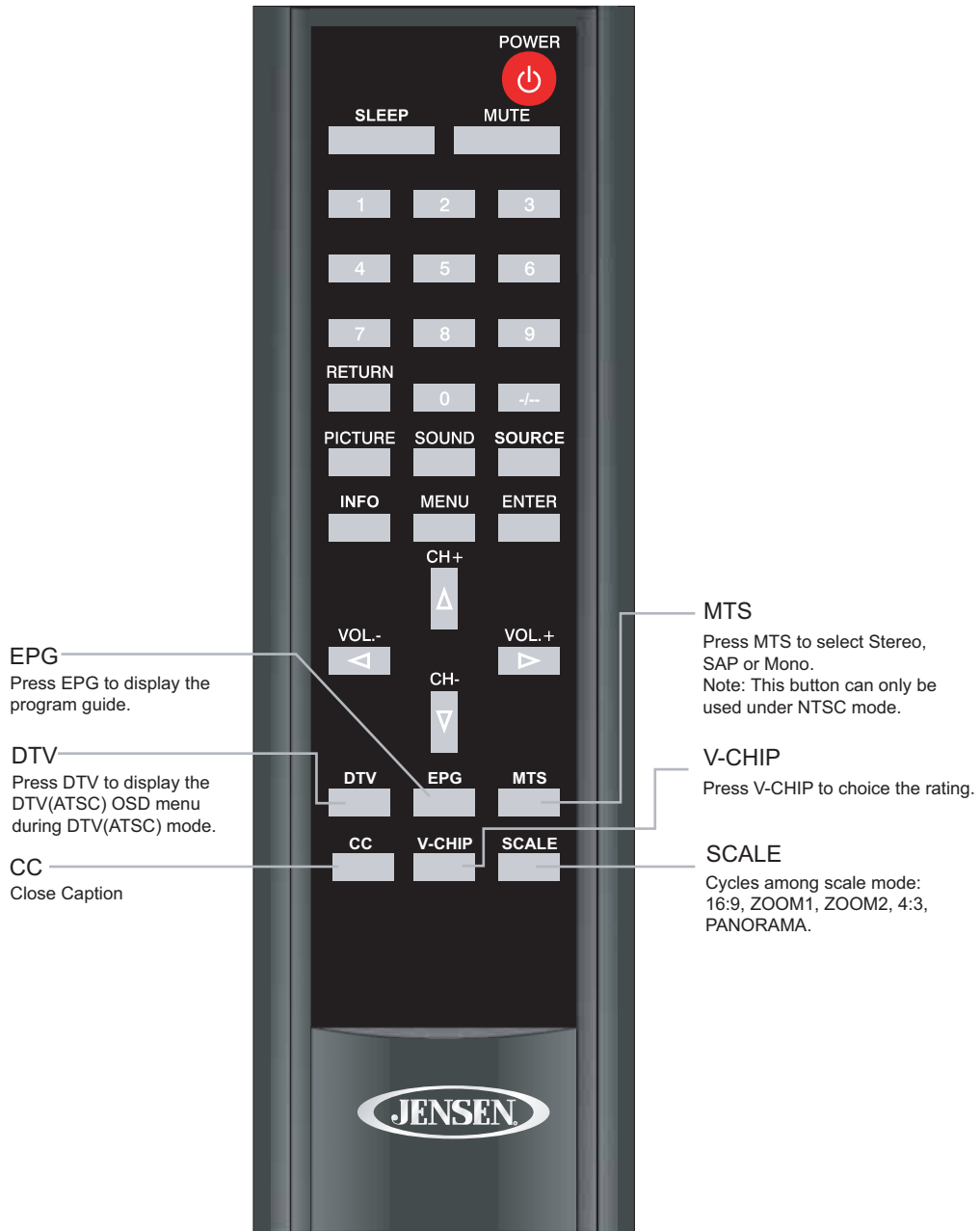

Precautions

Avoiding Remote Control Problems

1. Check the polarity (+,-) of the batteries in the remote control.
2. Check that the batteries have power.
3. Check that the LCD TV is powered and that it is properly plugged in.
4. Check if any three-wavelength lamp, special fluorescent or neon sign is turned on near the LCD TV.

Inserting Batteries in the Remote Control

1. Open the cover completely.
2. Insert the two supplied batteries (AAA, 1.5V). Ensure that the polarities (+ and -) of the batteries are aligned correctly.
3. Slide back the cover.

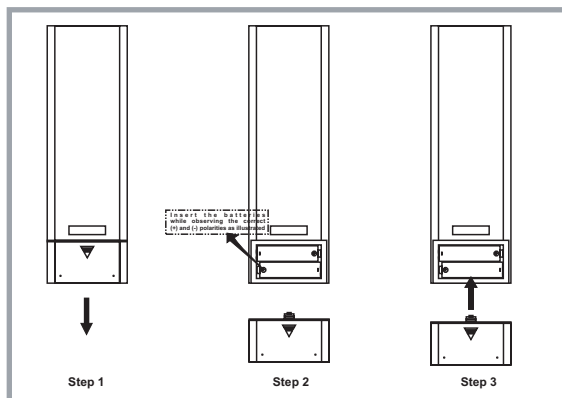

⚠ CAUTION : Risk of explosion if battery is replaced by an incorrect type.
Dispose of used batteries according to the national code (Recycling program).

How to use remote control

- The remote control should be operated within 30feet(7m) and 30 ° to the left and the right of the IR receiver at the front of the LCD TV.
- Used batteries should be disposed properly.

VCR Connections

- Connecting to the Composite terminal

※ Connection terminals of other equipments differ by manufacturer and model.

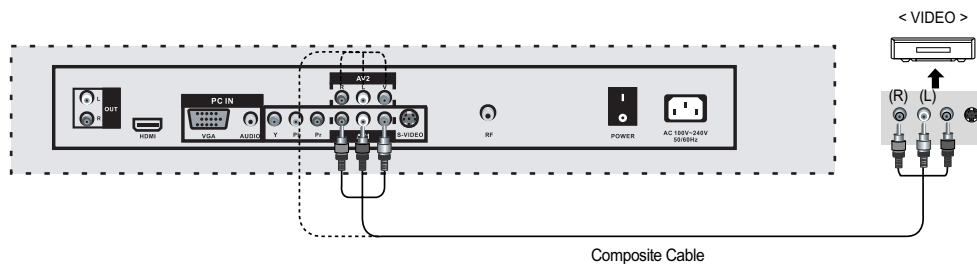

- Connect the LCD TV's Composite In terminal to the VCR's Composite Out terminal using the Composite cable. (Make sure the color of the terminals and the color of the cable are the same)

- Connecting to the S-Video terminal

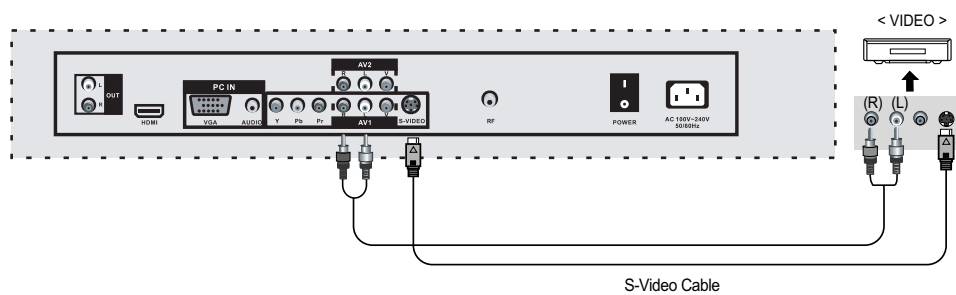

※ Use the S-Video cable for higher picture quality.

Watching Video Tape

1. Turn on the LCD TV and press  on the remote control.

2. Use   to move to "AV 1 or 2".

· If S-Video has been connected, select "S-Video".

3. Turn on the VCR, insert the tape and press play button.

Satellite/ Cable TV Set-Top Box Connections

● Connecting to the Composite terminal

- ※ In order to watch Cable TV, Subscribe to your local Cable TV company and install a separate receiver(Set-Top-Box)
- ※ Connection terminals of other equipments differ by manufacturer and model.

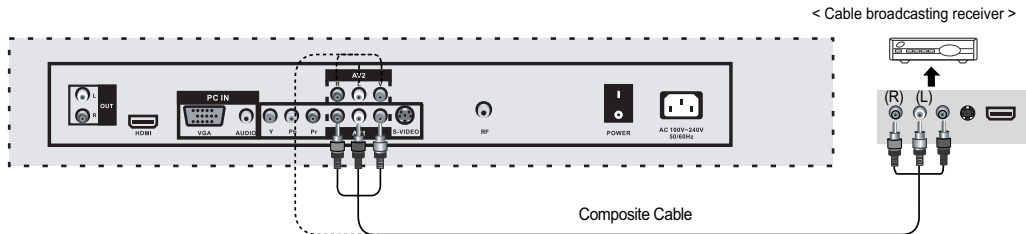

Connect the LCD TV's Composite In terminal to the cable broadcasting receiver Composite Out terminal using the Composite cable. (Make sure the color of the terminals and the color of cable are the same)

● Connecting to S-Video terminal

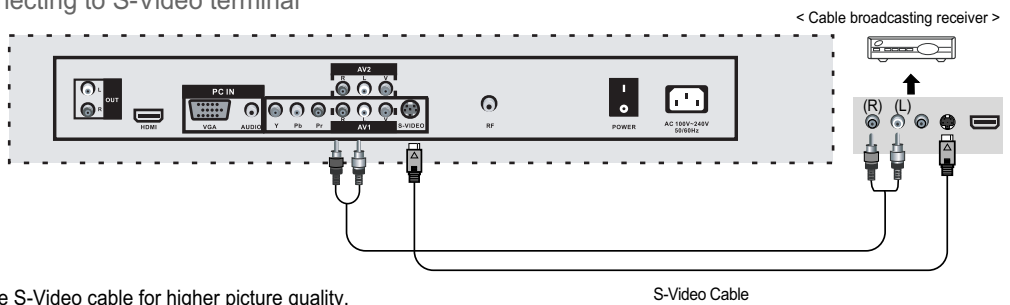

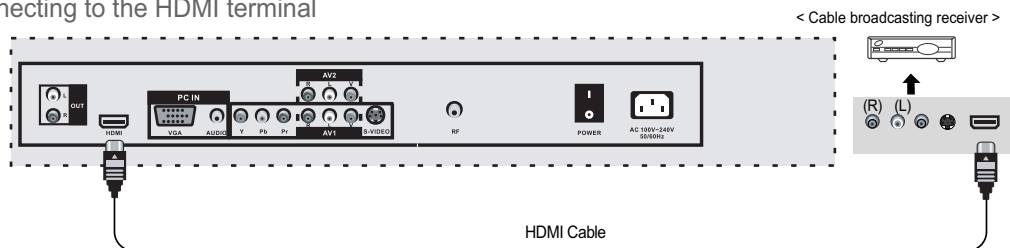

Use the S-Video cable for higher picture quality.

● Connecting to the HDMI terminal



Watching Cable TV

1. Turn on the LCD TV and press  on the remote control.
2. Use   to move to "AV 1 or 2".
 - If S-Video has been connected, select "S-Video".
 - If HDMI has been connected, select "HDMI".
3. Turn on the cable broadcasting receiver and select the channel you wish to view.

Connection

DVD Connections

● Connecting to the component terminal

※ Connection terminals of other equipments differ by manufacturer and model.

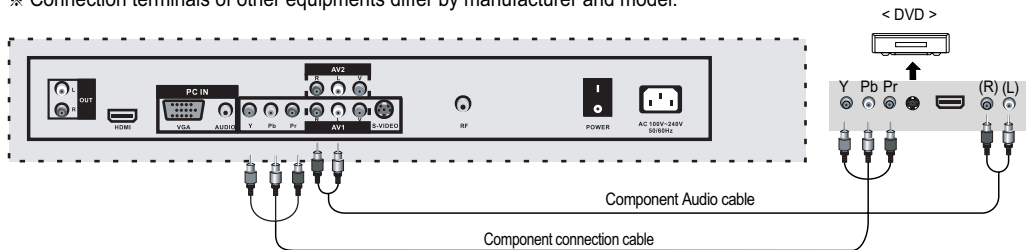

1. Connect LCD TV's Y, Pb, Pr terminal to DVD's Video Out terminal using the external cable.
2. Connect LCD TV's Audio terminals (left & right) in AV 1 to DVD's Audio Out terminal using the Audio cable.
3. It must match the component connection cable Y, Pb, Pr between the LCD TV and DVD Player.

● Connecting to the S-Video terminal

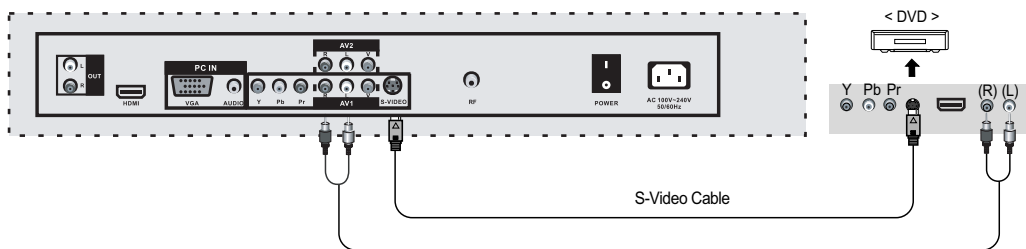

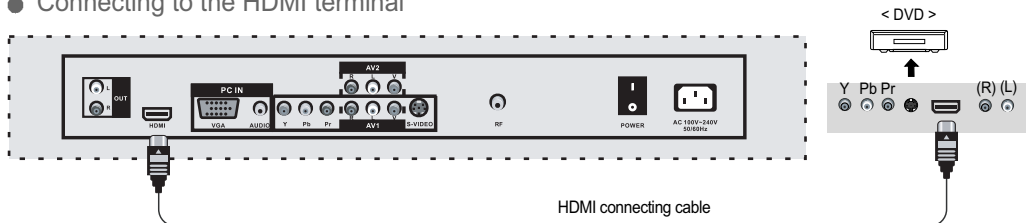

※ S-Video cable can be used if there is an S-Video terminal.

● Connecting to the HDMI terminal



· Connecting from HDMI terminal to HDMI terminal.

Playing the DVD

1. Turn on the LCD TV and press  on the remote control.
2. Use   to move to "YPbPr".
 - If S-Video has been connected, select "S-Video".
 - If HDMI has been connected, select "HDMI".
3. Turn on the DVD, insert the DVD disc and press Play button.

Connection

PC Connections

※ Connection terminals of other equipments differ by manufacturer and model.

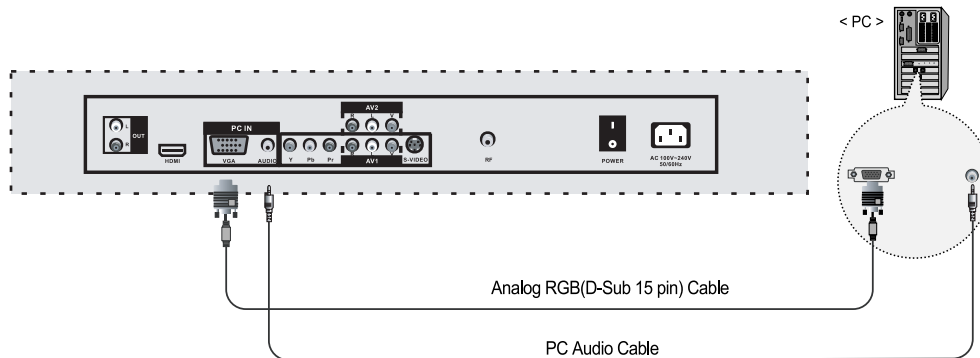

- Connect LCD TV's PC Input terminal to PC's RGB terminal using the D-Sub cable.
- Connect LCD TV's PC Audio terminal to PC's Audio terminal using the Audio cable.
Only for PC's with Audio terminal)

How to Use as PC monitor

1. Turn on the LCD TV and press  on the remote control.

2. Use   to move to "VGA".

Audio Amplifier Connections

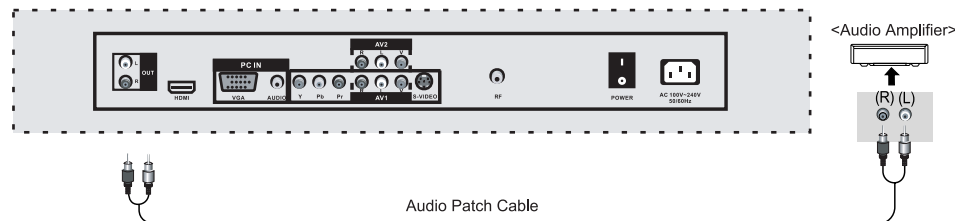

※ Connection terminals of other equipments differ by manufacturer and model.



- Connect LCD TV's AUDIO(L/R) output terminal to Audio Amplifier using an audio patch cable.
Note: The speakers of LCD TV still have output audio signal at this time.
- You can use the Volume +/- buttons to adjust the output audio signal.

Powering the LCD TV

- Power on/ off

Press  on the back of the LCD TV to  first.

· To turn the LCD TV on :

Press the "POWER" button.

· To turn the LCD TV off :

Press "POWER" button on the LCD TV.

· To turn on/off by remote control :

Press the "POWER" button of remote control.

Selecting Input Source

- You can select between the TV signal and the input signal of other equipments connected to the TV.
- Use this function to switch to the input source you wish to view.

Press  button on the remote control.

Use  to move to the desired input source.

Press  to select.

If you select TV, you can receive the ATSC/NTSC signal.

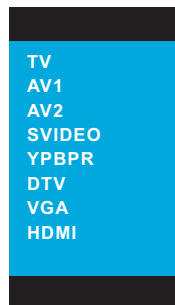

- Channel Up and Channel Down



channel up

channel down

- You will see all the channels that the TV has memorized.

- To go back to the previous channel

Press



to go back to the channel you were previously viewing.

- Volume Control



increases the volume.

decreases the volume.

- To turn sound off only

- Use the mute function to turn off the LCD TV sound for a while, when a phone or a bell rings.

Press



again to hear the sound again.



- The information about the current channel

Press



on the remote control.

- Display shows information about current channel if it is provided by the broadcaster.

Press



again to disappear.

Operating the Menu

1. Press the POWER button to turn the LCD TV on.
2. Press the MENU button on the remote control, the on-screen menu will appear on the screen.
3. Use the UP and DOWN buttons to select your main menu option.

PICTURE MENU:

Allows you to make adjustments to your picture settings.
(select TV source for example)

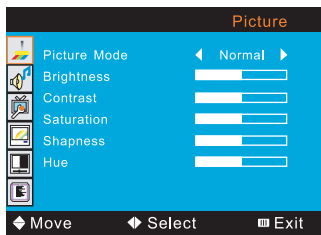

SOUND MENU:

Allows you to customize the audio option and effects.
(Select TV source for example)

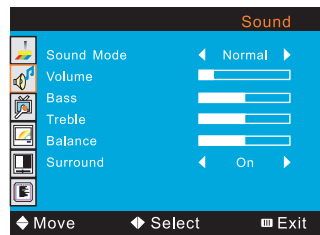

FUNCTION MENU:

Allows you to set up a variety of features: Language, Blue Back, Timer, Close Caption, Parent Guide and Reset.
(Select TV source for example)

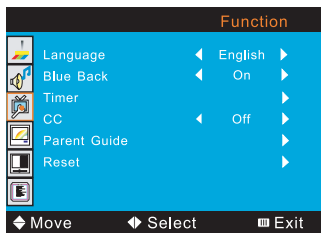

TV MENU:

Allows you to search channels.
(Select TV source)

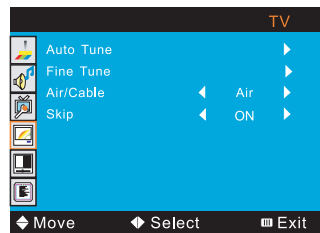

PC MENU:

Allows you to set up a variety of features.
(Select PC source)

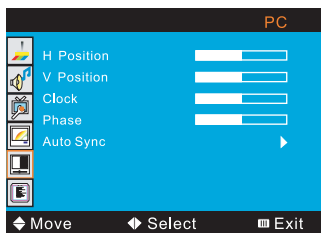

ADVANCED MENU:

Allows you to set up a variety of advanced function.
(Select TV source)

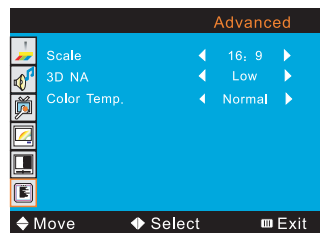

3. Use the UP / DOWN buttons to select an option of the sub-menu, and press the RIGHT button. While in adjustment mode, use the LEFT/RIGHT button to change the value of the item.
4. Press the MENU button to exit the menu.

Note:

Only when you input the suitable signal, the relevant items can be activated.

Setting up the DTV(ATSC) Function

Scanning the Digital TV channel

1. With the LCD TV connected to a television programming source, press the SOURCE button on the remote control to select DTV mode.
2. Press the DTV button on the remote control to display the main menu, and use the LEFT and RIGHT buttons to select.



3. Select Channel item first, then press the DOWN button to select Auto Scan, and press the ENTER button.

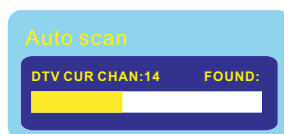
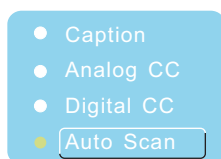

4. The Auto Scan automatically store the receivable channels. Press the DTV button at any time to interrupt the memorization process.

Setting up the DTV(ATSC) Function

The DTV(ATSC) menu includes the following options:

| | |
|-----------------------|---|
| Channel | |
| Caption | Allows to set closed caption ON or OFF. |
| Analog Close Caption | Allows to set basic analog closed caption options: CC1/CC2/CC3/CC4 |
| Digital Close Caption | Allows to set digital closed caption options: Service 1/Service 2/Service 3/ Service 4/ Service 5/ Service 6 |
| Auto Scan | Automatically store the receivable channels. Press the TV button at any time to interrupt the memorization process. |

Caption

Allows to customize the settings for caption option



Channel



Caption



Setup



Lock

Font Style

- Font Size
- Foreground Color
- Background Color
- Foreground Opacity
- Background Opacity

Setup



Channel



Caption



Setup



Lock

Picture Size

- Time Zone

| | |
|--------------|---|
| Picture Size | Allows you to select picture size between Auto and Full. |
| Time Zone | Allows selection of regional TV systems of USA: Pacific/ Mountain/ Central/ Eastern |

Setting up the DTV Function

Using the Lock Settings

Use RIGHT button to highlight the LOCK item, then press ENTER.
The unit will demand you input the 4-digital password first. The factory password is 0000.

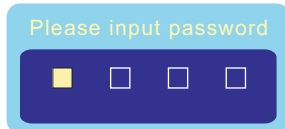

After you input the right password, the screen will display as following:

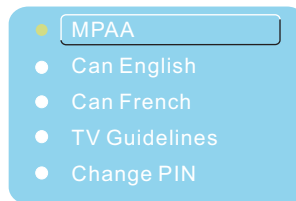

The LOCK item includes the following options:

| MPAA | The Movie rating (MPAA) is used for original movies rated by the Motion Picture Association of America (MPAA) as broadcasted on cable TV and not edited for television. Use UP or DOWN button to select NA, G, PG, PG-13, R, PG-17 or X. | | | | | | | | | | | | | | |
|-------------|---|--------|-------------|---|---|----|--|-------|--|---|--|-------|-------------------------------|---|-------------|
| | <table border="1"> <thead> <tr> <th>RATING</th> <th>DESCRIPTION</th> </tr> </thead> <tbody> <tr> <td>G</td> <td>General Audiences. Movie is appropriate for all ages.</td> </tr> <tr> <td>PG</td> <td>Parental Guidance Suggested. May contain material not suited for younger viewers</td> </tr> <tr> <td>PG-13</td> <td>Contains content that may not be appropriate for viewers under the age of 13</td> </tr> <tr> <td>R</td> <td>Restricted. Contains adult content, no one under 17 admitted without parent.</td> </tr> <tr> <td>NC-17</td> <td>No one 17 and under admitted.</td> </tr> <tr> <td>X</td> <td>Adults only</td> </tr> </tbody> </table> | RATING | DESCRIPTION | G | General Audiences. Movie is appropriate for all ages. | PG | Parental Guidance Suggested. May contain material not suited for younger viewers | PG-13 | Contains content that may not be appropriate for viewers under the age of 13 | R | Restricted. Contains adult content, no one under 17 admitted without parent. | NC-17 | No one 17 and under admitted. | X | Adults only |
| RATING | DESCRIPTION | | | | | | | | | | | | | | |
| G | General Audiences. Movie is appropriate for all ages. | | | | | | | | | | | | | | |
| PG | Parental Guidance Suggested. May contain material not suited for younger viewers | | | | | | | | | | | | | | |
| PG-13 | Contains content that may not be appropriate for viewers under the age of 13 | | | | | | | | | | | | | | |
| R | Restricted. Contains adult content, no one under 17 admitted without parent. | | | | | | | | | | | | | | |
| NC-17 | No one 17 and under admitted. | | | | | | | | | | | | | | |
| X | Adults only | | | | | | | | | | | | | | |
| Can English | Use UP or DOWN button to select NA, C, C8+, G, PG, 14+ or 18+. | | | | | | | | | | | | | | |
| Can French | Use UP or DOWN button to select NA, G, 8 Ans+, 13 Ans+, 16 Ans+, 18 Ans+. | | | | | | | | | | | | | | |

Setting up the DTV(ATSC) Function

TV Guidelines

| | ALL | FV | V | S | L | D |
|-------|--------------------------|-------------------------------------|-------------------------------------|-------------------------------------|-------------------------------------|-------------------------------------|
| TV-Y | <input type="checkbox"/> | <input checked="" type="checkbox"/> | <input checked="" type="checkbox"/> | <input checked="" type="checkbox"/> | <input checked="" type="checkbox"/> | <input checked="" type="checkbox"/> |
| TV-Y7 | <input type="checkbox"/> | <input type="checkbox"/> | <input checked="" type="checkbox"/> | <input checked="" type="checkbox"/> | <input checked="" type="checkbox"/> | <input checked="" type="checkbox"/> |
| TV-G | <input type="checkbox"/> | <input checked="" type="checkbox"/> | <input checked="" type="checkbox"/> | <input checked="" type="checkbox"/> | <input checked="" type="checkbox"/> | <input checked="" type="checkbox"/> |
| TV-PG | <input type="checkbox"/> | <input checked="" type="checkbox"/> | <input type="checkbox"/> | <input type="checkbox"/> | <input type="checkbox"/> | <input type="checkbox"/> |
| TV-14 | <input type="checkbox"/> | <input checked="" type="checkbox"/> | <input type="checkbox"/> | <input type="checkbox"/> | <input type="checkbox"/> | <input type="checkbox"/> |
| TV-MA | <input type="checkbox"/> | <input checked="" type="checkbox"/> | <input checked="" type="checkbox"/> | <input type="checkbox"/> | <input type="checkbox"/> | <input type="checkbox"/> |

Use the UP and DOWN buttons to select the rating you want and press the ENTER button to select Blocked Rating or Unblocked Rating.

Change PIN

Use DOWN button to select the Change PIN item, then press ENTER. The screen will display as following:

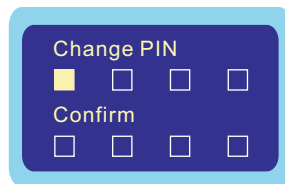

Input the new 4-digital password and input it again to confirm. The screen will display "New Pin Success"

Customizing the PICTURE Settings

Select TV source for example. (Press SOURCE button to select TV mode)

1. Press the POWER button to turn the LCD TV on.
2. Press the MENU button on the remote control to display the Main menu, and use the UP and DOWN buttons to select the PICTURE.
3. Use the UP and DOWN buttons to highlight an individual PICTURE option, use the LEFT and RIGHT buttons to change the setting, and press the MENU to exit the menu.

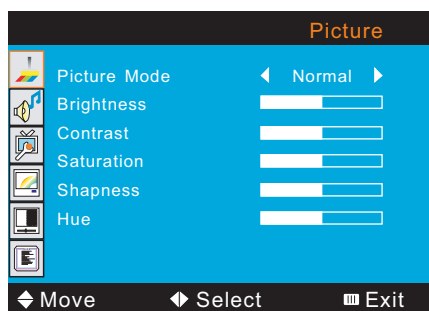

The PICTURE menu includes the following options :

| | |
|--------------|--|
| Picture Mode | Cycles among picture display modes: User, Normal, Soft, Vivid. |
| Brightness | Controls the overall brightness of the picture |
| Contrast | Controls the difference between the brightest and darkest regions of the picture. |
| Saturation | Controls the color intensity. |
| Sharpness | Increase this setting to see crisp edges in the picture; decrease it for soft edges. |
| Hue | Controls the difference between the green and red regions of the picture. |

Customizing the SOUND Settings

Select TV source for example. (Press SOURCE button to select TV mode)

1. Press the POWER button to turn the LCD TV on
2. Press the MENU button on the remote control to display the Main menu, and use the UP and DOWN buttons to select the SOUND
3. Use the UP and DOWN buttons to highlight an individual SOUND option, use the LEFT and RIGHT buttons to change the setting, and press the MENU to exit the menu

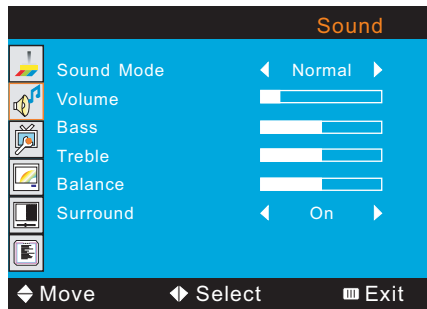

The SOUND menu includes the following options :

| | |
|------------|--|
| Sound Mode | Cycles among sound display modes: User, Normal, News, Movie . |
| Volume | To adjust the volume. |
| Bass | Controls the relative intensity of lower pitched sounds. |
| Treble | Controls the relative intensity of higher pitched sounds |
| Balance | To adjust the balance of the left and right sound track, or turn off the volume of the left and right sound track. |
| Surround | Allows you to turn the surround on or off |

Customizing the FUNCTION Settings

Select TV source for example. (Press SOURCE button to select TV mode)

1. Press the POWER button to turn the LCD TV on.
2. Press the MENU button on the remote control to display the Main menu, and use the UP and DOWN buttons to select the FUNCTION.
3. Use the UP and DOWN buttons to highlight an individual FUNCTION option, use the LEFT and RIGHT buttons to change the setting, and press the MENU to exit the menu.

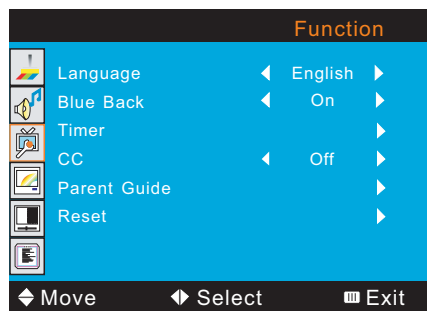

The FUNCTION menu includes the following options :

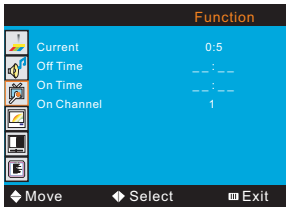
| | |
|----------------|--|
| Language | Selects to display all on-screen menus in your language of choice : English/ Français/ Español |
| Blue Back | To turn the blue back on or off. |
| Timer |  <p>Current Input the current time. Off Times Allows you to set the off times to turn off the unit automatically. On Times Allows you to set the on times to turn on the unit automatically. On channel The number of the current channel.</p> |
| Closed Caption | <p>Allows to select the following closed caption modes:</p> <ul style="list-style-type: none"> • CC1/CC2/CC3/CC4 Display a printed version of the dialog and sound effects of the program beging views. • T1/T2 Display station information presented using either half or the while screen. • T3/T4 Extended Data Services. For example: Network name, Program name, Program length, etc. • Off <p>NOTE : The Closed Caption item can only be activated under TV1 mode.</p> |
| Reset | Restores factory settings except parental and password options. |

Customizing the FUNCTION Settings

Using the Parent Guide Settings

NOTE: The Parent Guide item can only be activated under TV mode.

The US has 2 rating system for viewing content: Movie rating (MPAA) and TV rating.

The TV rating conjuncts with the V-CHIP to help parents block inappropriate programs from their children.

The Movie rating (MPAA) is used for original movies rated by the Motion Picture Association of America (MPAA) as broadcasted on cable TV and not edited for television.

The V-CHIP can also be set to block MPAA-rated movies.

1. Use the DOWN button to select "Parent Guide" in the Function menu, then press the RIGHT button to display the Parent Guide menu.

NOTE : Use the Parent Guide function, must enter a 4-digital password first. The factory password is 0000.

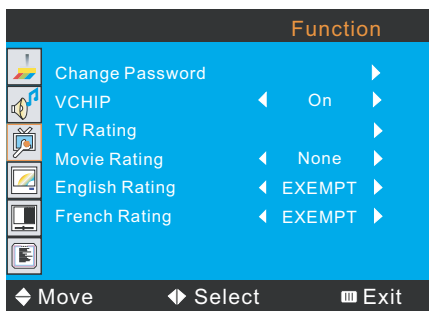
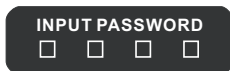

2. Select V-CHIP Enable ON.

The Movie Rating includes the following options:

| RATING | DESCRIPTION |
|--------|---|
| G | General Audiences. Movie is appropriate for all ages. |
| PG | Parental Guidance Suggested. May contain material not suited for younger viewers. |
| PG-13 | Contains content that may not be appropriate for viewers under the age of 13. |
| R | Restricted. Contains adult content, no one under 17 admitted without parent. |
| NC-17 | No one 17 and under admitted. |
| X | Adults only. |
| None | |

Use the LEFT and RIGHT buttons to select the rating you want.

Customizing the FUNCTION Settings

Using the Parent Guide Settings

The TV Rating includes the following options

| | | ALL | FV | V | S | L | D |
|-----------|-------|-----|----|---|---|---|---|
| AGE-BASED | TV-Y | U | | | | | |
| | TV-Y7 | U | U | | | | |
| | TV-G | U | | | | | |
| | TV-PG | U | | U | U | U | U |
| | TV-14 | U | | U | U | U | U |
| | TV-MA | U | | U | U | U | |

Use the UP and DOWN buttons to select the rating you want and press the ENTER button repeatedly to select Blocked Rating (B) or Unblocked Rating (U)

The Parent Guide MENU includes the following options :

Change Password

Use DOWN button to select "Change Password" and press RIGHT.



Input the new 4-digital password and input it again to confirm.

VCHIP

To select VCHIP on or off.

TV Rating

Selects to activate the TV Rating programs.

Movie Rating

Selects to activate the MPAA Rating programs.

English Rating

Allows you to select among: EXEMPT, C, C8, G, PG, 14+ and 18+.

French Rating

Allows you to select among: EXEMPT, G, 8 Antst+, 13 Antst+, 16 Antst+ and 18 Antst+.

Customizing the TV Settings

1. Press the POWER button to turn the LCD TV on.
2. Press the SOURCE button on the remote control to select TV mode.
3. Press the MENU button on the remote control to display the Main menu, and use the UP and DOWN buttons to select the TV.
4. Use the UP and DOWN buttons to highlight an individual TV option, use the LEFT and RIGHT buttons to change the setting, and press the MENU to exit the menu.

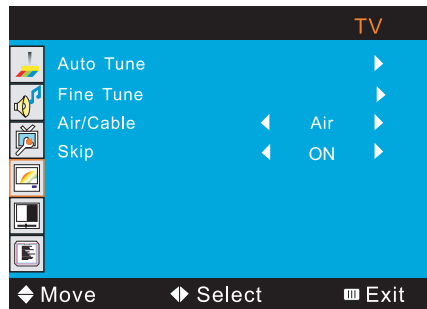

The TV menu includes the following options :

Auto Tune

Press RIGHT to automatically search the channels



Automatically store the receivable channels. When searching channels, press MENU to stop.

Fine Tune

Allows to fine tune channel

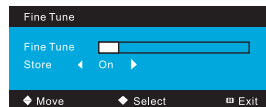

Select "On" in Store item, then the unit will store the receivable channels automatically.

Customizing the TV Settings

Air/ Cable

Allows selection among HRC, Air, STD and IRC signal sources

Skip

Allows addition/ removal of channels.

Customizing the PC Settings

1. Press the POWER button to turn the LCD TV on.
2. Press the SOURCE button on the remote control to select VGA mode.
3. Press the MENU button on the remote control to display the Main menu, and use the UP and DOWN buttons to select the PC.
4. Use the UP and DOWN buttons to highlight an individual PC option, use the LEFT and RIGHT buttons to change the setting, and press the MENU to exit the menu.

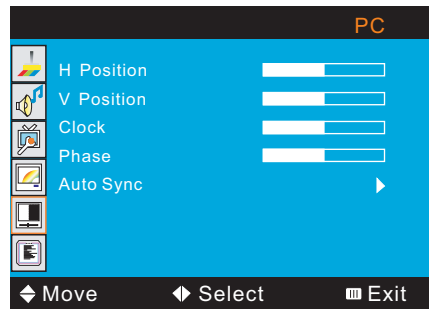

The PC menu includes the following options :

| | |
|------------|--|
| H Position | Allow you to use LEFT and RIGHT button to adjust the H Position. |
| V Position | Allow you to use LEFT and RIGHT button to adjust the V Position. |
| Clock | Allow you to prolong the image. |
| Phase | Allow you to adjust the definition. |
| Auto Sync | Select "Auto Sync" and press RIGHT, the unit will automatically adjust all items to achieve a best effect. NOTE : We recommend you to do this operation to achieve a best effect. |

Customizing the ADVANCED Settings

Select TV source for example. (Press SOURCE button to select TV mode)

1. Press the POWER button to turn the LCD TV on.
2. Press the MENU button on the remote control to display the Main menu, and use the UP and DOWN buttons to select the ADVANCED.
3. Use the UP and DOWN buttons to highlight an individual ADVANCED option, use the LEFT and RIGHT buttons to change the setting, and press the MENU to exit the menu.

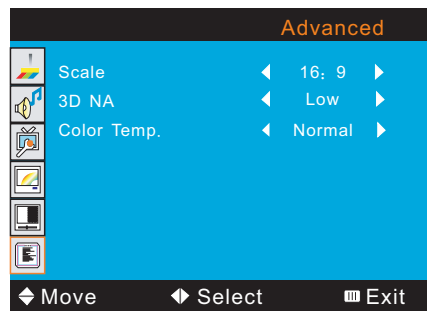

The ADVANCED menu includes the following options :

| | |
|-------------------|---|
| Scale | Cycles among scale mode: 16:9, ZOOM1, ZOOM2, 4:3, PANORAMA. |
| 3D NA | Allows you to adjust the 3D NA among: LOW, Mid, High, Off. |
| Color temperature | <p>Adjusts color components independently to achieve a warm or cool effect: Use/ Normal/ Warm/ Cool</p> <ul style="list-style-type: none"> • User: Allows the user to adjust red, green and blue color component levels independently. |

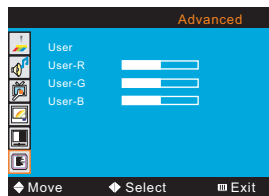

- Normal
- Warm
- Cool

Trouble shooting

- Do not use other functions that are not mentioned in this user's manual.
- In case a problem occurs with your LCD TV, please take the following steps first.
- If you still have the problem, turn the power off and contact your dealer or an authorized service center.

| Problem | Action |
|---|--|
| The screen does not appear. | Is the power plug pulled out? Insert the power plug. Press the power button of the remote control. |
| The screen appears too slowly after the power is turned on. | This problem occurs for a brief time in the process of image elimination processing in order to hide temporary screen noise that occurs when the power is turned on. But if the screen does not come after 1 minute contact your dealer or an authorized service center. |
| Screen is too bright or too dark. | Perform brightness adjustment or Contrast adjustment. |
| Screen is too large or too small. | Adjust the screen size. |
| Stripes appear on the screen and it shakes. | Stop using wireless telephones, hair driers and electric drills. |
| The screen does not move. | Press the PAUSE button. Check if the Pause button is pressed on external equipment. |
| Screen appears, Voice is not heard | <ol style="list-style-type: none"> 1. Press the "MUTE" button. 2. Increase the sound level by pressing volume adjustment button. 3. Check if sound terminal of external input is connected properly. 4. Check if audio cables are connected properly. 5. Select and check the other input. <p>If the sound still does not work and the other channels are the same after you have done as the above, contact your dealer or an authorized service center.</p> |
| Remote control does not work | <ol style="list-style-type: none"> 1. Check if main power is On. 2. Check that the batteries of the remote controller were loaded properly. 3. Check to see if any obstacle exists between the LCD TV and the remote control, then remove it, if any. 4. If the batteries have no power, replace them with two new batteries. |

- This LCD TV is for household use and registered as harmless on electromagnetic waves.
- Therefore, you can use it in every location as well as residential areas.

Specifications

| | | |
|-------------------|----------------|---|
| LCD Panel | Panel Size | 42" TFT LCD |
| | Brightness | 500 |
| | Contrast Ratio | 1500:1 |
| | Viewing Angle | 180° |
| Max. Resolution | | 1920 x 1080 |
| Input Connector | VIDEO | 2 |
| | S-VIDEO | 1 |
| | YPbPr | 1 |
| | AUDIO (L/R) | 2 |
| | VGA/AUDIO | 1 |
| | HDMI | 1 |
| | RF | 1 |
| Output Connector | AUDIO (L/R) | 1 |
| Power Source | | AC 110-240V, 50/60HZ |
| Power Consumption | | 230W |
| Dimension | | 1055 W x 736 H x 127 D mm (without bracket) |
| Weight (N.W.) | | 27.5 Kg |

- The cabinet design and electronics specifications will be modified without prior notice for improving the performance.
- Weight and dimensions are approximate

LCD-TV Wall mounting assembly instruction

1. Lay the TV down with the rear facing up on a non-abrasive surface.
2. Remove the six screws shown in figure A with a Phillips screwdriver.



Figure A

3. Remove the stand from the TV by pulling it out of the cabinet. See Figure B.



Figure B

4. Insert the supplied plastic stand cover as shown in Figure C and D.



Figure C



Figure D

5. Remove the 4 screws shown in Figure E.



Figure E

6. Attach the wall mounting bracket (not supplied) using these 4 screws.



www.asaelectronics.com

