

SERIES
6

LCD TV

quick start guide

imagine the possibilities

Thank you for purchasing this Samsung product.
To receive more complete service, please register
your product at

www.samsung.com/register

SAMSUNG

Connections

⚠ Caution

- When connecting an external device, match the colour of the connection terminal to the cable.
- The product colour and shape may vary depending on the model.
- Each Cable Box/Satellite receiver (Set-Top Box) has a different back panel configuration.
- Whenever you connect an external device to your TV, make sure that power on the unit is turned off.

CONNECTING A CABLE BOX/SATELLITE RECEIVER (SET-TOP BOX) VIA HDMI

LA32B650 / LA40B650 / LA46B650 / LA55B650 /

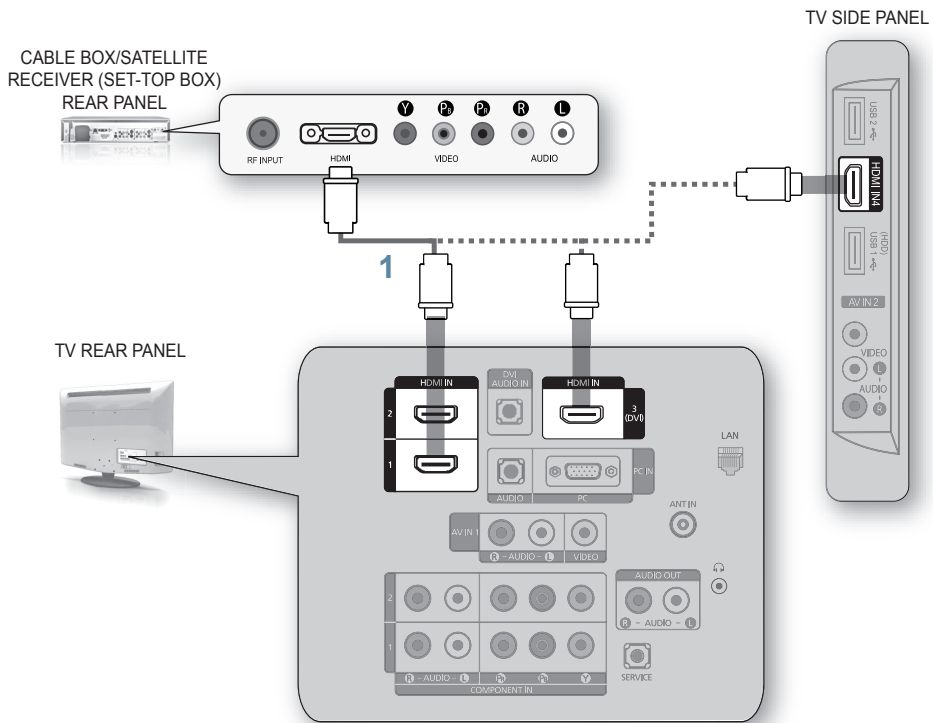

1. Connect an HDMI Cable (Not supplied) between the **HDMI IN (1, 2, 3 or 4)** jack on the TV and the HDMI jack on the Cable Box/Satellite receiver (Set-Top Box).

✍ No additional Audio connection is needed for an HDMI to HDMI connection.

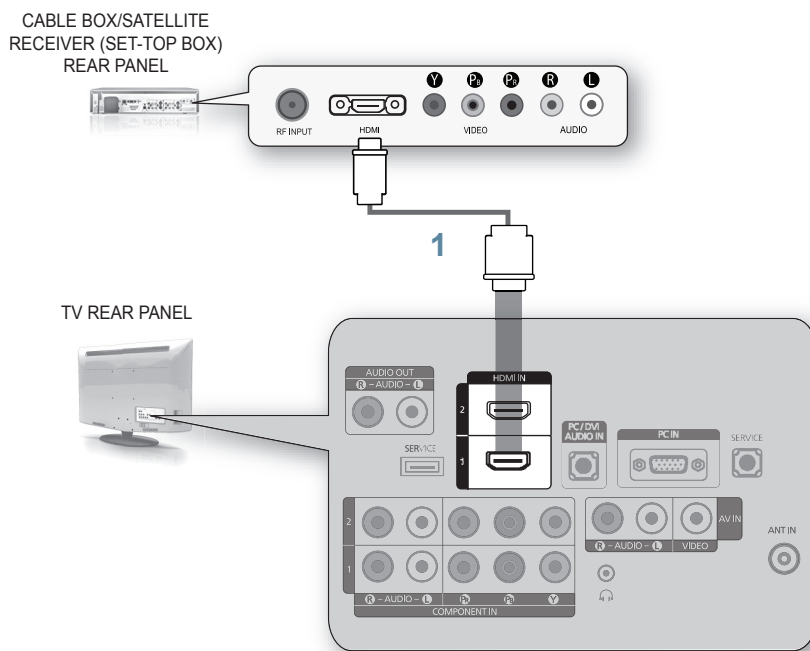

-
1. Connect an HDMI Cable (Not supplied) between the **HDMI IN (1 or 2)** jack on the TV and the HDMI jack on the Cable Box/Satellite receiver (Set-Top Box).

No additional Audio connection is needed for an HDMI to HDMI connection.

CONNECTING A CABLE BOX/SATELLITE RECEIVER (SET-TOP BOX) VIA DVI

LA32B650 / LA40B650 / LA46B650 / LA55B650 /

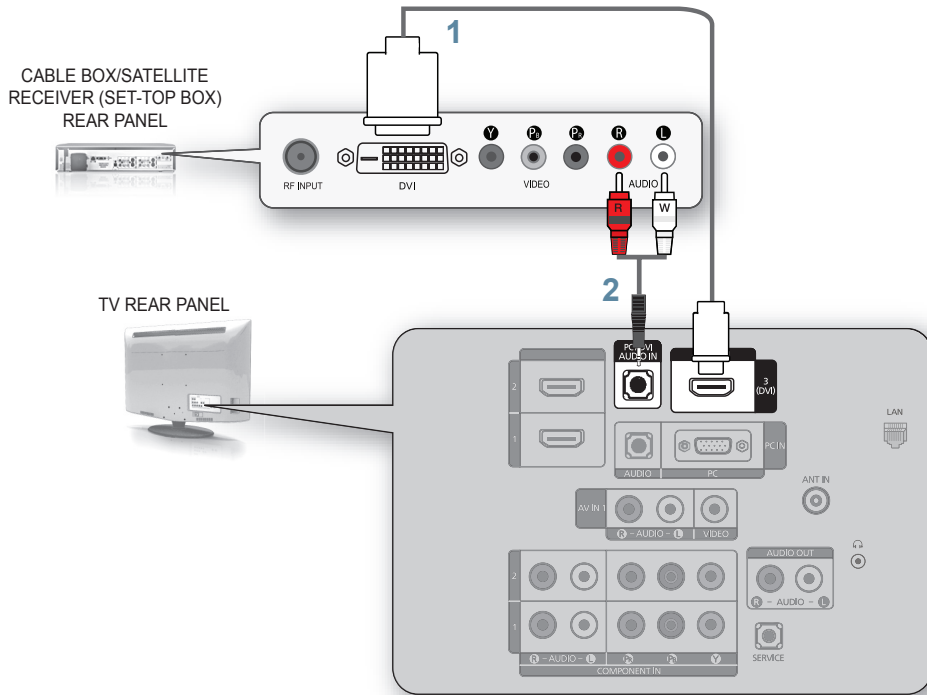

1. Connect an HDMI Cable (Not supplied) between the **HDMI IN(DVI) 3** jack on the TV and the HDMI jack on the Cable Box/Satellite receiver (Set-Top Box).
 2. Connect Audio Cables (Not supplied) between the **PC/DVI AUDIO IN** jack on the TV and the Cable Box/Satellite receiver (Set-Top Box).
- When using an HDMI/DVI cable(Not supplied) connection, you must use the **HDMI IN(DVI) 3** jack.

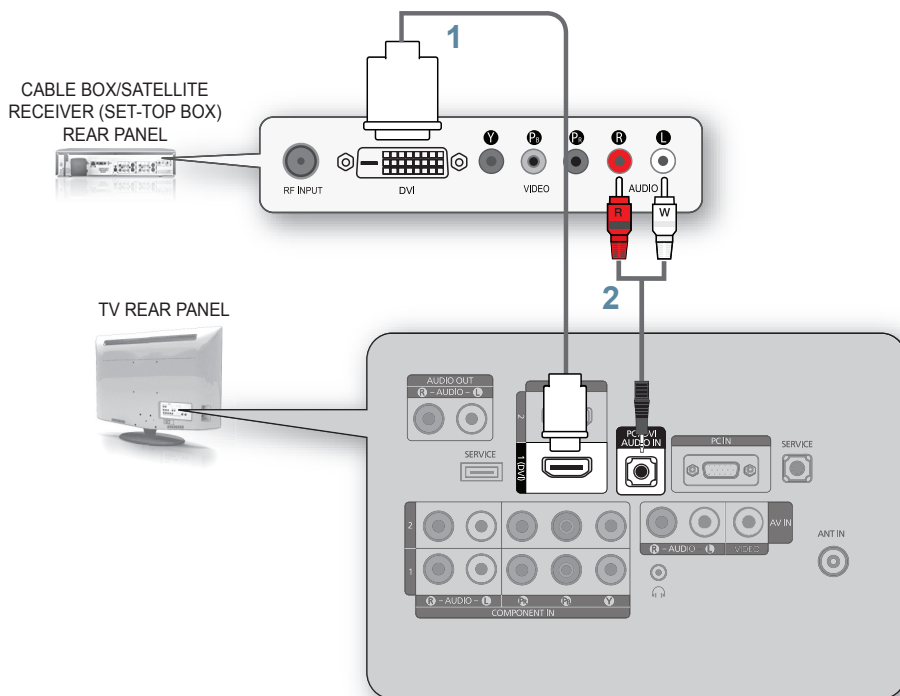

1. Connect an HDMI Cable (Not supplied) between the **HDMI IN(DVI) 1** jack on the TV and the HDMI jack on the Cable Box/Satellite receiver (Set-Top Box).
 2. Connect Audio Cables (Not supplied) between the **PC/DVI AUDIO IN** jack on the TV and the Cable Box/Satellite receiver (Set-Top Box).
- 📝 When using an HDMI/DVI cable(Not supplied) connection, you must use the **HDMI IN(DVI) 1** jack.

CONNECTING A CABLE BOX/SATELLITE RECEIVER (SET-TOP BOX) VIA COMPONENT CABLES

LA32B650 / LA40B650 / LA46B650 / LA55B650 /

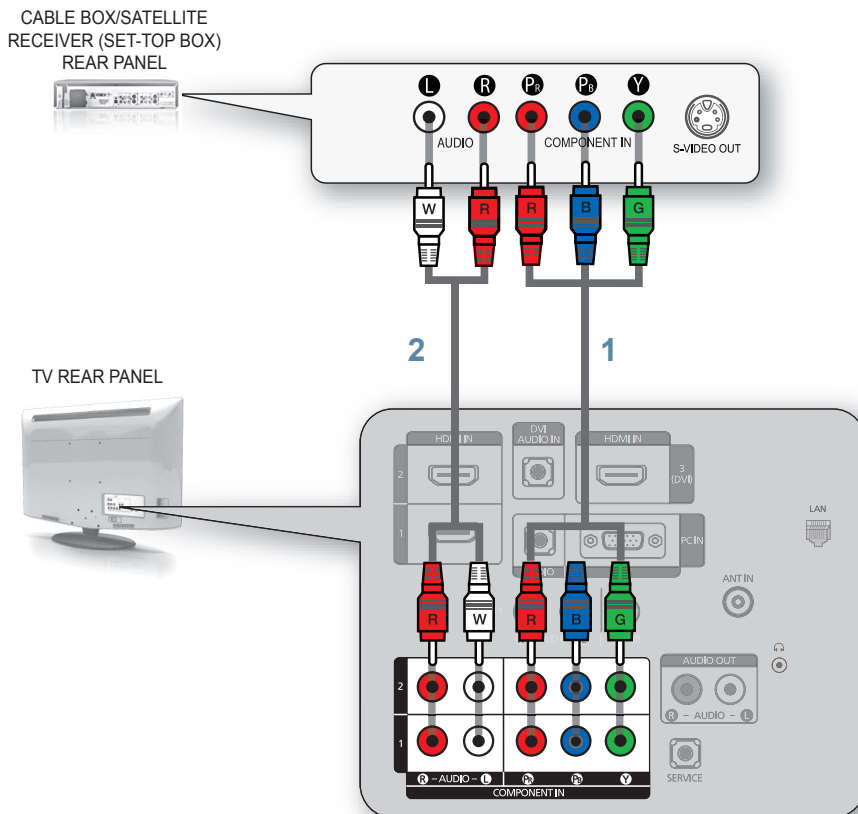

1. Connect a Component Cable (Not supplied) between the **COMPONENT IN (1 or 2) [Y, Pb, Pr]** jacks on the TV and the **COMPONENT** jacks on the Cable Box/Satellite receiver (Set-Top Box).
2. Connect Audio Cables (Not supplied) between the **COMPONENT IN (1 or 2) [R-AUDIO-L]** jacks on the TV and the **AUDIO OUT** jacks on the Cable Box/Satellite receiver (Set-Top Box).

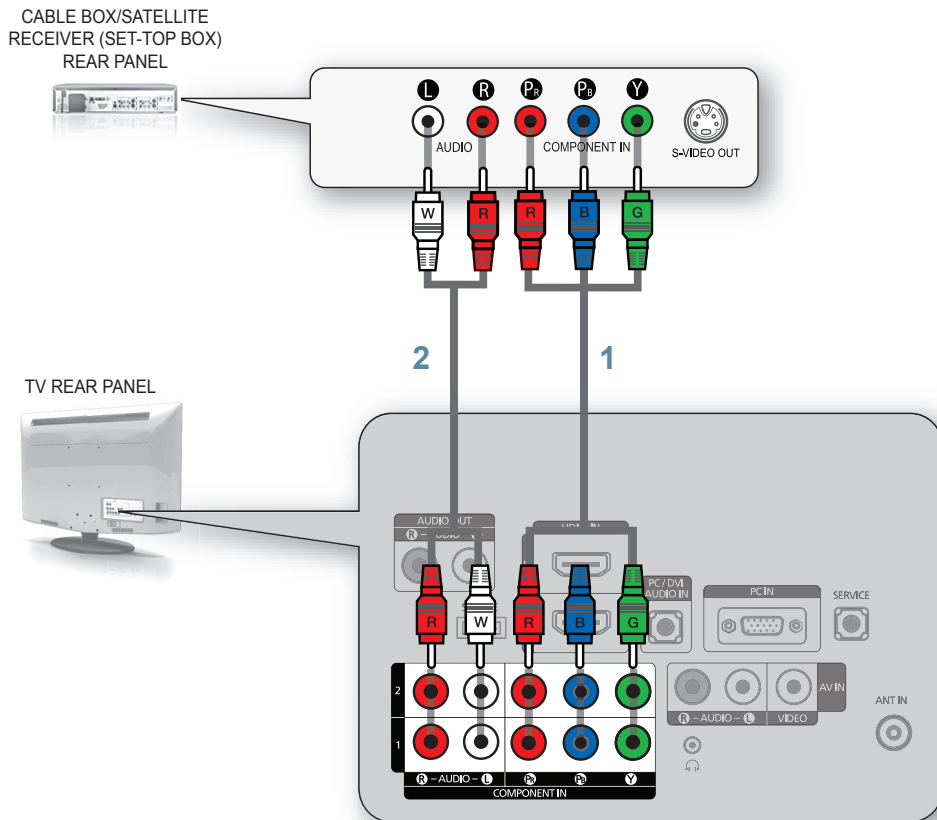







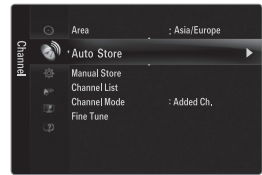

1. Connect a Component Cable (Not supplied) between the **COMPONENT IN (1 or 2) [Y, Pb, Pr]** jacks on the TV and the COMPONENT jacks on the Cable Box/Satellite receiver (Set-Top Box).
2. Connect Audio Cables (Not supplied) between the **COMPONENT IN (1 or 2) [R-AUDIO-L]** jacks on the TV and the AUDIO OUT jacks on the Cable Box/Satellite receiver (Set-Top Box).

Storing Channels Automatically

You can scan for the frequency ranges available to you (and availability depends on your area). Automatically allocated programme numbers may not correspond to actual or desired programme numbers. However, you can sort numbers manually and clear any channels you do not wish to watch.



1. Press the **MENU** button to display the menu.
Press the **▲** or **▼** button to select **Channel**, then press the **ENTER**  button.
2. Press the **▲** or **▼** button to select **Auto Store**, then press the **ENTER**  button.
3. Press the **▲** or **▼** button to select the channel source to memorize.
Press the **ENTER**  button to select **Start**.
 -  If a channel is locked using the **Child Lock** function, the PIN input window appears.
 -  Scans for all channels with active broadcast stations and stores them in the TV's memory.
 -  If you want to stop Auto Store, press the **ENTER**  button.
The **Stop Auto Store?** message will be displayed.
Select **Yes** by pressing the **◀** or **▶** button, then press the **ENTER**  button.
4. Press the **EXIT** button to exit.

Troubleshooting

My TV is out of order.	Why?	Try this.
TV HD is displayed, but the visual quality is not good.	<ul style="list-style-type: none"> • The visual quality may be degraded when the broadcasting stations convert the analog signal to digital. (Although you are watching digital broadcasting, the video source is analog.) 	<ul style="list-style-type: none"> • Check the transmitting signal of the corresponding cable TV network or broadcasting station.
The picture on the TV screen is broken intermittently (a mosaic or distorted).	<ul style="list-style-type: none"> • This may occur when the broadcast signal received by the TV is too weak or unstable. 	<ul style="list-style-type: none"> • Check the transmitting signal of the corresponding cable TV network or broadcasting station. • If you are using a publically shared antenna, check the signal by asking your apartment manager.
I cannot control the TV using the remote control.	<ul style="list-style-type: none"> • When the battery is flat. • When it is not in TV mode. • When the remote control malfunctions temporarily. 	<ul style="list-style-type: none"> • Replace the battery and then retry. • Press the TV button on the remote control to select TV mode.
A strange sound is generated by the TV.	<ul style="list-style-type: none"> • Sound may be generated by the temporary swelling and shrinking of the plastics in the TV due to temperature and humidity changes. • Temporary electronic oscillation sounds may be generated due to the characteristics of the TV 	<ul style="list-style-type: none"> • Some noise can be heard due to the characteristics of the product.



Contact SAMSUNG WORLDWIDE

If you have any questions or comments relating to Samsung products, please contact the SAMSUNG customer care centre.

COUNTRY	Customer Care Center ☎	Web Site
AUSTRALIA	1300 362 603	www.samsung.com/au
CHINA	800-810-5858 400-810-5858 010-6475 1880	www.samsung.com/cn
	HONG KONG:3698-4698	www.samsung.com/hk
INDIA	3030 8282 1-800-3000-8282 1800 110011	www.samsung.com/in
INDONESIA	0800-112-8888	www.samsung.com/id
JAPAN	0120-327-527	www.samsung.com/jp
MALAYSIA	1800-88-9999	www.samsung.com/my
NEW ZEALAND	0800 SAMSUNG (0800 726 786)	www.samsung.com/nz
PHILIPPINES	1-800-10-SAMSUNG(726-7864) 1-800-3-SAMSUNG(726-7864) 02-5805777	www.samsung.com/ph
SINGAPORE	1800-SAMSUNG(726-7864)	www.samsung.com/sg
THAILAND	1800-29-3232 02-689-3232	www.samsung.com/th
TAIWAN	0800-329-999	www.samsung.com/tw
VIETNAM	1 800 588 889	www.samsung.com/vn
SOUTH AFRICA	0860-SAMSUNG(726-7864)	www.samsung.com/za
U.A.E	800-SAMSUNG (726-7864) 8000-4726	www.samsung.com/ae