

Quick Setup Guide

SERIES 6+
680

Congratulations on the purchase of your new Samsung TV. Read this setup guide to get your TV up and running quickly.



1-800-SAMSUNG (1-800-726-7864)
Samsung Electronics America, Inc.
85 Challenger Road Ridgefield Park, NJ 07660-2112
Samsung Electronics Canada Inc.
55 Standish Court Mississauga, Ontario L5R 4B2
Call Center hours of operation: Mon-Sun, 9:00 AM -12 AM EST.
To register this product, visit: www.samsung.com/register.

Step 1: Install the Stand

50 inches model only

Follow the steps below to connect the TV to the stand.

NOTE

- Make sure to distinguish between the front and back of the Stand and Guide Stand when assembling them.
- Make sure that at least two persons lift and move the PDP TV.
- Stand the product up fasten the screws. If you fasten the screws with the PDP TV placed down, it may lean to one side.

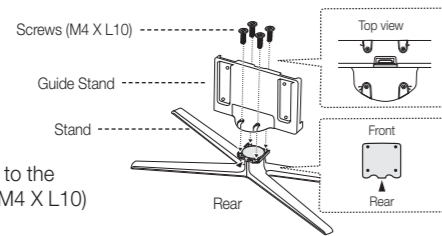

1 Connect the Guide Stand to the Stand using four screws (M4 X L10) as shown.

2 With your TV upright, connect the

3 Fasten two screws (M4 X L12) at position 1, and then fasten the two screws (M4 X L12) at position 2.

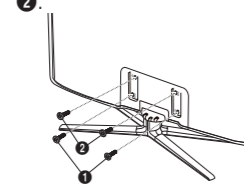
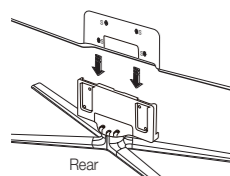

Step 2: Install the Batteries into the Remote

To install batteries into your remote control, follow these steps:

- Lift the cover on the back of the remote upward as shown in the figure to the right.
- Install two AAA batteries.
 - Make sure to match the + and - ends of the batteries to the diagram in the battery compartment.
- Replace the cover.

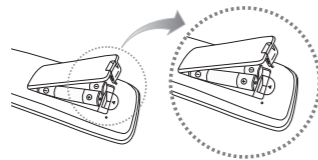

Step 3: Connect Power and Antenna or Cable

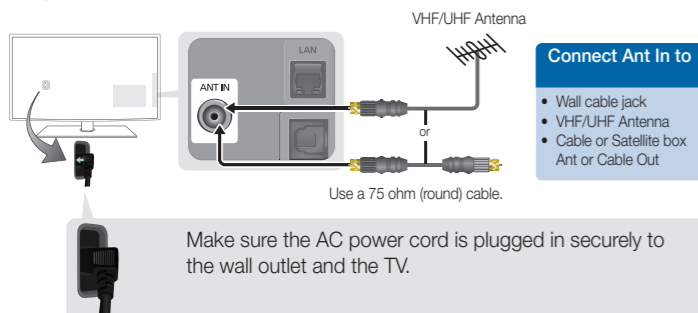

Make sure the AC power cord is plugged in securely to the wall outlet and the TV.

Step 4: Connect External Devices

Connecting an AV device (DVD/Blu-ray player, cable/satellite box, etc.)

Use one of the connections below to connect your TV to an external AV device. We recommend using HDMI for the highest picture quality.

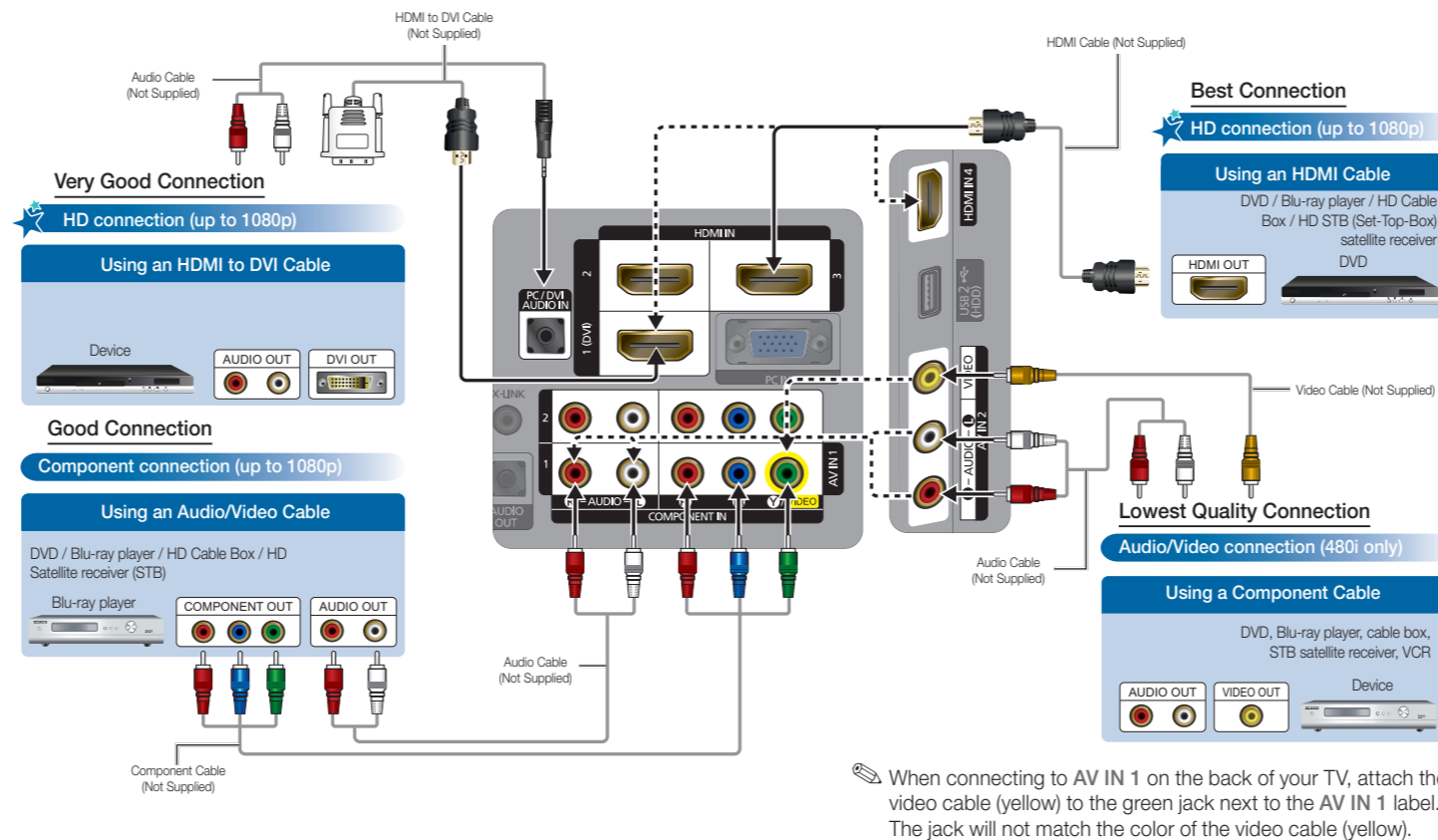

When connecting to AV IN 1 on the back of your TV, attach the video cable (yellow) to the green jack next to the AV IN 1 label. The jack will not match the color of the video cable (yellow).

Step 5: Run Plug & Play

When you turn on your TV for the first time, it automatically launches the Plug & Play function. With Plug & Play, you can select the On Screen Display language, set the clock mode, and launch the TV's channel memorizing process.

It also displays connection instructions similar to those in this guide. To navigate while Plug & Play is running, press the Up, Down, Left or Right arrow buttons on your remote. To make a selection, press the ENTER button. To skip a screen, press the MENU button. To turn on your TV, press the POWER button on the remote or on the TV. To run Plug & Play, follow these steps:

- Using your remote control, select the language for the On Screen Display (OSD), and then press the ENTER button.
- Select **Home Use**, and then press the ENTER button. If you select **Store Demo**, the TV will reset your picture and audio settings every 30 minutes.
- Select **Antenna Source** and **Channel Source**. If **Antenna Source** is **Cable** or **Auto**, you must select **Channel Source** to same type as your cable system type. After selecting source, select **Search**; then press the ENTER button on your remote.
 - Most cable systems are Standard(STD) systems, if you are not sure about what kind of cable system you have, contact your cable company.
 - If your TV is attached to a cable or satellite box, skip Steps 3 through 5. After Plug & Play is complete, set your TV to Channel 3 or 4, according to the directions for your cable or satellite box.
- The TV memorizes the available channels. This process can take up to 45 minutes.
- After the TV has memorized the channels, choose the **Clock Mode**. Select **Auto** if you have a digital channel in your area. Select **Manual** if you don't, or if you have a cable or satellite box. When done, press the ENTER button.
 - If you select **Manual**, the clock setting screen appears.

- Select the daylight savings time setting: **Off** or **On**, and then press the ENTER button
- Select the time zone in which you live, and then press ENTER button.
- After the time zone screen, The connection method for best HD screen quality is displayed. Press Right arrow button on your remote to view each screen in succession. Press the Blue button to skip this section.
- The **Enjoy your TV** screen appears. Then press the ENTER button.

Changing the Screen Size

Your TV has several screen size options, each designed to work best with specific types of video input. If you have a cable box or satellite receiver, it may have its own set of screen sizes as well.

To change the screen size, press the P.SIZE button on your remote. The first time you press it, your TV displays the current setting. Thereafter, each time you press the P.SIZE button, you change the size of the picture on the screen.

The following sizes are available:

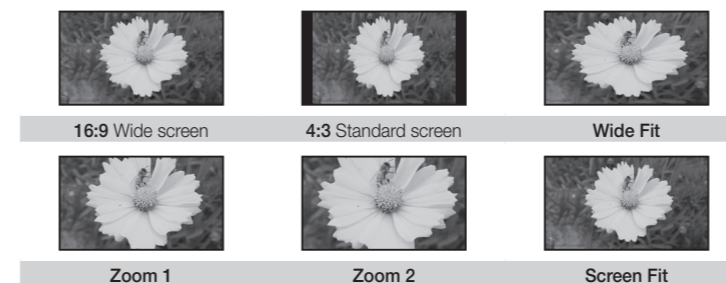

Screen Fit: Displays the full image without any cut-off when HDMI (720p / 1080i / 1080p) or Component (1080i / 1080p) signals are inputted.

Connecting an audio device (Home Theater, etc.)

Connect your TV to your Home Theater or other audio device to enjoy enhanced Sound quality.

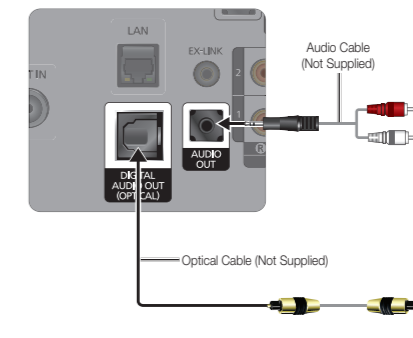

Analog Audio connection

Using an Audio Cable

Amplifier / DVD home theater

Digital Audio connection

Using an Optical Cable

Digital Audio System

Connecting a PC

Connect your TV to a PC to use it as a Monitor.

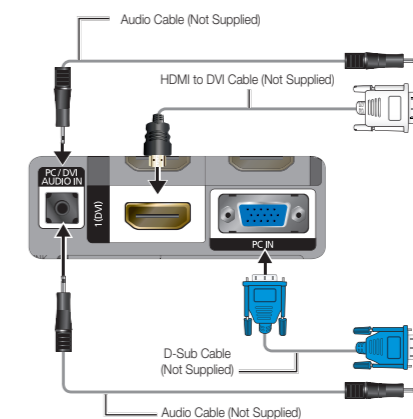

HD connection

Using a DVI to HDMI Cable

Using an D-Sub Cable

Changing the Picture Mode

Your TV has four preset **Picture Modes** with factory adjusted settings, each designed to give you an excellent picture under specific conditions.

To change the **Picture mode**, press the P.MODE button on your remote. The first time you press it, your TV displays the current setting. Thereafter, each time you press the P.MODE button, you change the mode of the picture on the screen.

The **Picture Modes** are listed and described in the table below:

Mode	Description
Dynamic	Brightens picture. For a vibrant, enhanced image in brightly lit or sunny room.
Standard	For a bright, detailed picture in a normally lit room.
Movie	For a studio quality cinema picture in a dimly lit or dark room.

To change the **Picture Mode**, follow these steps:

- Turn on your TV, press the TOOLS button on your remote. The **Tools** menu appears.
- Using the ▲ or ▼ on your remote, select **Picture mode**.
- On the **Picture mode** menu, use the ◀ or ▶ on your remote to select the **Picture mode** you want.
- Press the EXIT button to exit the menu.

Setting the Clock

Before you can use your TV's On/Off Timer, you must set the clock. To set the clock, follow these steps:

- Turn on your TV, press the MENU button on your remote, then select **Setup** → **Time**.
- Select **Clock Mode**, and then press the ENTER button.
- Choose **Auto** or **Manual**.
 - If you select **Auto**, the current time will be set automatically using the time from a digital channel.
 - If you select **Manual**, you can set the **Month, Day, Year, Hour, Minute** and **am/pm** directly by pressing up, down, left and right arrow button on your remote.
- Press the RETURN button on your remote when done.

Step 6: Remote Control

Remote Control Buttons and Functions

This is a special remote control for the visually impaired and has Braille points on the Power, Channel, Volume, Stop, and Play/Pause buttons.

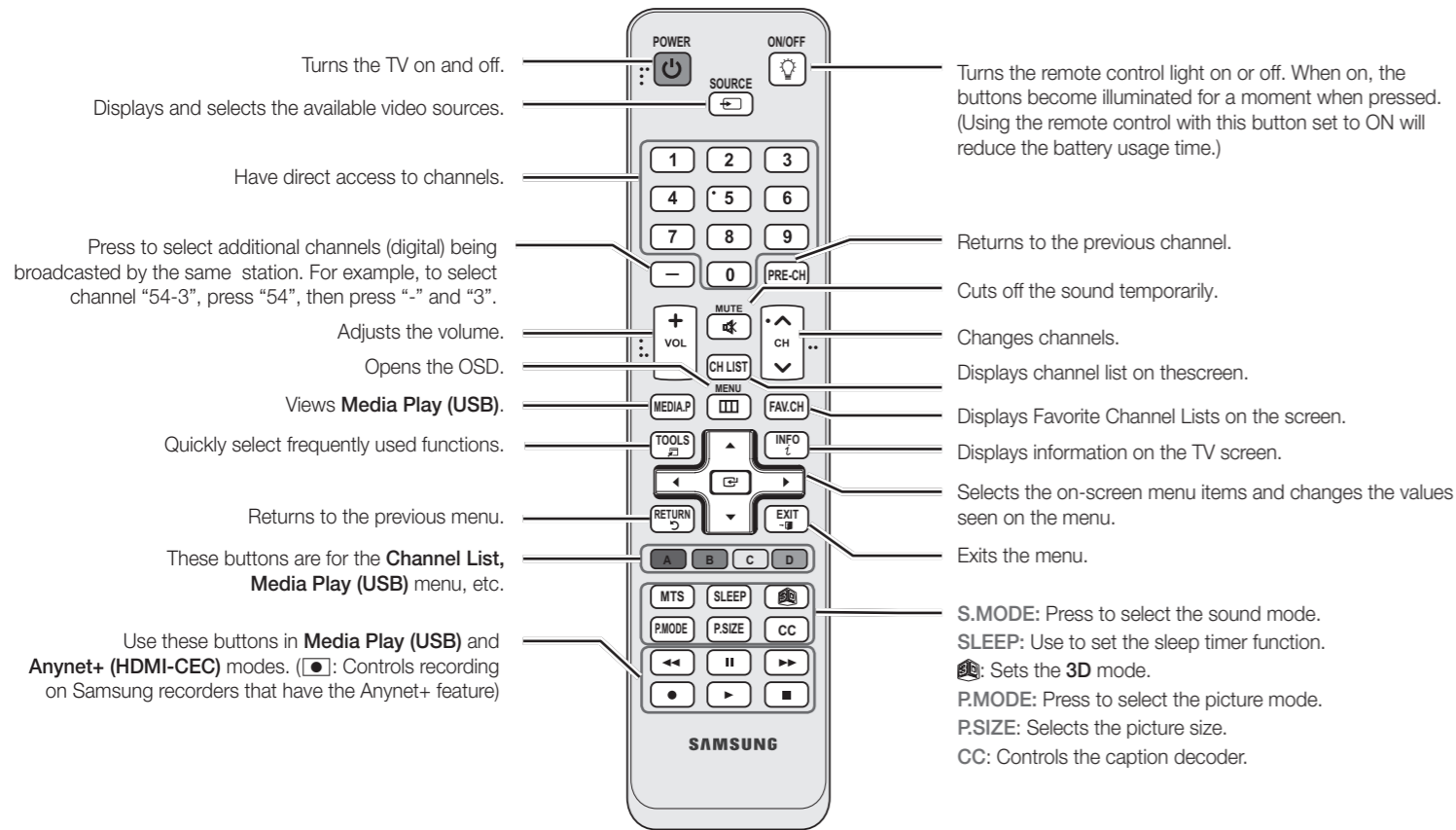

Changing Channels and Adjusting the Volume

Adjust the volume by pressing the Volume button on the remote.



Change the channels by pressing the Channel button on the remote.

If your TV is attached to a cable or satellite box, change the channel using the box's remote.

You can also change the channels by pressing the **CH** button on the front panel of your TV and adjust the volume by pressing the **-VOL+** button.

Viewing the On Screen Menus

To view the On Screen Menus, follow these steps:

- Turn on your TV, press the MENU button on your remote. The main menu appears. The menu's left side has the following menu options: **Picture, Sound, Channel, Setup, Input, Application, and Support**.
- Press the **▲** or **▼** button on your remote to select a menu option, and then press the ENTER button.
- When done using the menu, press the EXIT button on your remote to exit.



Selecting a Source

To watch a movie on your Blu-ray player or watch your favorite TV show, you must select the correct source. A source is a device, such as a Blu-ray/DVD player, a cable/satellite box, antenna or a cable TV input. Sources can be connected to your TV through the HDMI, DVI, Component, Composite, or D-sub connections, or through the Antenna or Cable In connections.

To view the signal from a source connected to the HDMI, DVI, Component, Composite, or D-sub jack, press the SOURCE button on your remote. Each time you press the SOURCE button, you change to a different source.

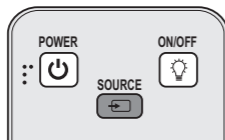

Step 7: Media Play Features

The Media Play feature lets you connect to your PC through your home network and stream PC audio and video files to your HDTV using your remote. To use IPTV or Samsung PC Share Manager, you must connect your TV to your network. You can attach the TV to your network in two ways, by cable, using CAT 5 cable, or wirelessly, using a Samsung Wireless LAN Adapter. Instructions for both connection methods are below.

Network Connection - Wired

There are two main ways to connect your TV to your network using cable, depending on your network setup. They are illustrated below:

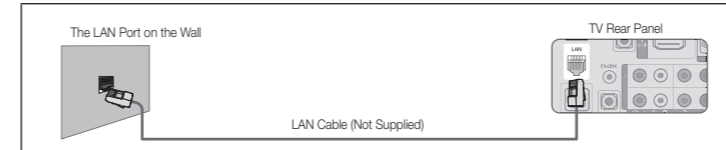
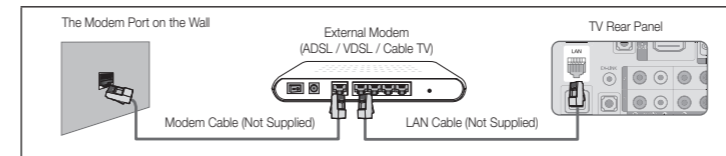

Configuring the Network Connection - Wired

Most home networks use the Dynamic Host Configuration Protocol (DHCP) to configure network connections. Home networks that support DHCP automatically provide the IP address, subnet mask, gateway, and DNS values your TV needs to access the Internet so you don't have to enter them manually.

To configure your network connection for a network that uses DHCP, follow these steps:

- Connect your TV to your network as shown in one of the illustrations above.
- Turn on your TV, press the MENU button on your remote, and then select **Setup** → **Network**.
- Set the **Network Type** to **Wired** if it is not already set to **Wired**.
- Select **Network Setup**. The **Network Setup** screen appears.
- On the **Network Setup** menu, set **Internet Protocol Setup** and **DNS** to **Auto**. **Auto** acquires and enters the necessary internet values automatically.
- Select **Network Test** to check Internet connectivity.

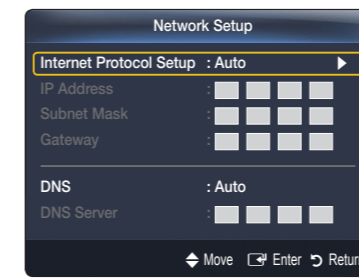

Some networks are Static IP networks. If your network is a Static IP network, you can not use DHCP to configure the network connection. Instead, you must enter the **IP Address, Subnet Mask, Gateway, and DNS Server** manually. For instructions explaining how to configure a Static IP network, see your user's manual.

Network Connection - Wireless

You can connect your TV to your LAN through a standard wireless router or modem. To connect wirelessly, you must first attach a "Samsung Wireless LAN Adapter" (WIS09ABGN, WIS09ABGN2, WIS10ABGN - sold separately) to either the USB 1 or USB 2 (HDD) port on the back of your TV. See the illustration below.

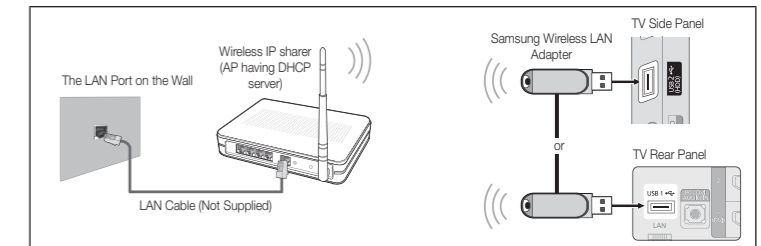

Samsung's Wireless LAN adapter is sold separately and is offered by select retailers, Ecommerce sites and Samsungparts.com. Samsung's Wireless LAN adapter supports the IEEE 802.11A/B/G and N communication protocols. Samsung recommends using IEEE 802.11N. When you play the video over a IEEE 802.11B/G connection, the video may not play smoothly.

Most wireless network systems incorporate a security system that requires devices that access the network through an access point or AP (typically a wireless IP Sharer) to transmit an encrypted security code called an access key.

If Pure High-throughput (Greenfield) 802.11n mode is selected and the Encryption type is set to WEP, TKIP or TKIPAES (WPS2Mixed) for your AP, Samsung TVs will not support a connection in compliance with new Wi-Fi certification specification

Configuring the Network Connection - Wireless

The instructions below are for networks that use the Dynamic Host Configuration Protocol (DHCP) to configure network connections automatically. If you have a Static IP network, see your user's manual for configuration instructions.

To configure your network connection for a network that uses DHCP, follow these steps:

- Connect your TV to your network as shown in the illustrations above.
- Turn on your TV, press the MENU button on your remote, and the select **Setup** → **Network**.
- Set the **Network Type** to **Wireless** if it is not already set to **Wireless**.
- Select **Network Setup**. The **Network Setup** screen appears.
- On the **Network Setup** menu, select an AP (Access Point) or ad hoc network. If you have selected a network with a **security key**, the Security Key screen appears.
- Enter the security key using the numbers on the remote, and then press the Blue button on your remote.
- If your network uses WEP security encryption, 0-9 and A-F will be available on the **Security Key** screen. Use the Direction button on your remote to move to the characters and the enter key to select them.
- On the **Network Setup** menu, set **Internet Protocol Setup** and **DNS** to **Auto**. **Auto** acquires and enters the necessary internet values automatically.
- Select **Network Test** to check internet connectivity.

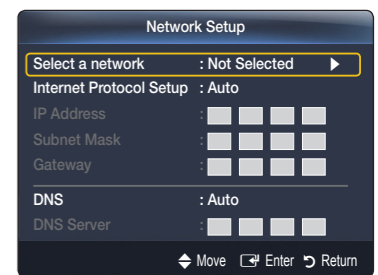

For more information, see your user's manual.

