

SONY®

2-635-386-12(2)

LCD Colour TV

Operating Instructions

△ Before operating the TV, please read the "Safety Information" section of this manual.
Retain this manual for future reference.

<http://www.sony.net/>

KLVS19A10U

Printed in Spain



263538612

2-635-386-12(2)



KLVS19A10U

BRAVIA

© 2005 Sony Corporation

NOTICE FOR CUSTOMERS

A moulded plug complying with BS1363 is fitted to this equipment for your safety and convenience.

Should the fuse in the plug supplied need to be replaced, a 5 AMP fuse approved by ASTA or BSI to BS 1362 (i.e., marked with  or ) must be used.

When an alternative type of plug is used it should be fitted with a 5 AMP FUSE, otherwise the circuit should be protected by a 5 AMP FUSE at the distribution board.

If the plug supplied with this equipment has a detachable fuse cover, be sure to attach the fuse cover after you change the fuse. Never use the plug without the fuse cover. If you should lose the fuse cover, please contact your nearest Sony service station.

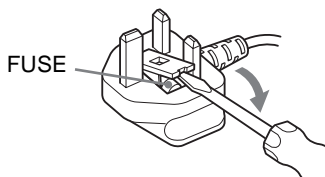

How to replace the fuse

Open the fuse compartment with a blade screwdriver, and replace the fuse.

WARNING

- To prevent the risk of electric shock, do not insert the plug cut off from the mains lead into a socket outlet. This plug cannot be used and should be destroyed.
- To prevent the risk of fire or electric shock, do not expose the TV set to rain or moisture.
- Dangerously high voltages are present inside the TV set. Do not open the cabinet. Refer servicing to qualified personnel only.

Introduction

Thank you for choosing this Sony product. Before operating the TV, please read this manual thoroughly and retain it for future reference.

Trademark information

- "PlayStation" is a trademark of Sony Computer Entertainment, Inc.
- Licensed by BBE Sound, Inc. under USP4638258, 4482866. "BBE" and BBE symbol are trademarks of BBE Sound, Inc.
- Manufactured under licence from Dolby Laboratories. "Dolby," "Pro Logic," and the double-D symbol  are trademarks of Dolby Laboratories.

Table of Contents

Safety information	4
Precautions	7
Overview of the remote	8
Overview of the TV buttons and indicators	9

Getting Started

1: Checking the accessories	10
2: Inserting batteries into the remote	10
3: Connecting an aerial/VCR	11
4: Preventing the TV from toppling over	12
5: Switching on the TV	12
6: Auto-tuning the TV	13

Watching TV

Watching TV	14
Viewing pictures from connected equipment	16

Using the Menu

Navigating through menus	16
Overview of the menus	17
Picture Adjustment menu	18
Picture Mode	18
Contrast/Brightness/Colour/Hue/Sharpness/ Backlight	18
Colour Tone	18
Reset	19
Noise Reduction	19
Sound Adjustment menu	20
Sound Effect	20
Treble/Bass/Balance	20
Reset	20
Dual Sound	21
Auto Volume	21
Screen menu	22
Auto Format	22
Screen Format	22
RGB Center	22
Features menu	23
Power Saving	23
Light Sensor	23
AV2 Output	23
TV Speakers	24

PC Adjustment	24
Timer menu	25
Sleep Timer	25
Set Up menu	26
Auto Start Up	26
Auto Tuning	27
Programme Sorting	27
Programme Labels	27
AV Preset	28
Manual Programme Preset	29

Using Optional Equipment

Connecting optional equipment	31
-------------------------------------	----

Additional Information

Specifications	34
Troubleshooting	36
Index	38

Safety information

Mains lead

- Unplug the mains lead when moving the TV set. Do not move the TV set with the mains lead plugged in. It may damage the mains lead and result in fire or electric shock.
- If you damage the mains lead, it may result in fire or electric shock.
 - Do not pinch, bend, or twist the mains lead excessively. The core conductors may be exposed or broken, causing a short-circuit, which may cause fire or electric shock.
 - Do not modify or damage the mains lead.
 - Do not put anything heavy on the mains lead. Do not pull the mains lead.
 - Keep the mains lead away from heat sources.
 - Be sure to grasp the plug when disconnecting the mains lead.
- If the mains lead is damaged, stop using it and ask your dealer or Sony service centre to exchange it.
- Do not use the supplied mains lead on any other equipment.
- Use only an original Sony mains lead, not other brands.

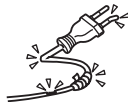

Mains lead/cable protection

Pull out the mains lead/cable by the plug. Do not pull on the mains lead/cable itself.

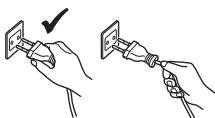

Mains

Do not use a poor fitting mains socket. Insert the plug fully into the mains socket. A poor fit may cause arcing and result in fire. Contact your electrician to have the mains socket changed.

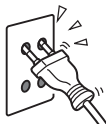

Optional accessories

Observe the following when installing the TV set using a stand or wall-mount bracket. If you do not do so, the TV set may fall and cause serious injury.



- It is strongly recommended that you use Sony accessories for safety reasons:
 - Wall-mount bracket SU-WL11,
- It is strongly recommended that you use the official Sony wall-mount bracket to allow adequate air circulation and to avoid dust build up around the TV, wall and ceiling.
- Secure the TV set properly, following the instructions supplied with your stand or wall-mount bracket when installing the TV set.
- Be sure to attach the brackets supplied with your stand.

Installation

If the TV set is to be installed on a wall, have the installation carried out by qualified service men. Improper installation may render the TV set unsafe.

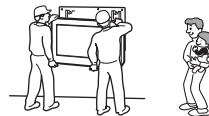

Medical institutions

Do not place this TV set in a place where medical equipment is in use. It may cause malfunction of medical instruments.

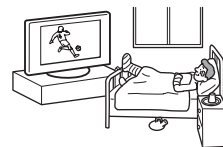

Carrying

- Before carrying the TV set, disconnect all the cables from the TV set.
- When you carry the TV set by hand, hold the TV set as illustrated on the right. If you do not do so, the TV set may fall and be damaged or cause serious injury. If the TV set has been dropped or damaged, have it checked immediately by qualified service personnel.
- When transporting it, do not subject the TV set to jolts or excessive vibration. The TV set may fall and be damaged or cause serious injury.
- When you carry the TV set in for repair or when you move it, pack it using the original carton and packing material.

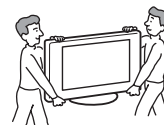

Ventilation

- Never cover the ventilation holes in the cabinet. It may cause overheating and result in fire.
- Unless proper ventilation is provided, the TV set may gather dust and get dirty. For proper ventilation, observe the following:
 - Do not install the TV set turned backwards or sideways.
 - Do not install the TV set turned over or upside down.
 - Do not install the TV set on a shelf or in a closet.
 - Do not place the TV set on a rug or bed.
 - Do not cover the TV set with cloth, such as curtains, or items such as newspapers, etc.
- Leave some space around the TV set. Otherwise, air-circulation may be inadequate and cause overheating, which may cause fire or damage to the TV set.

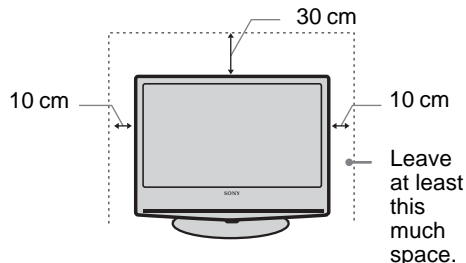

- When installing the TV set on the wall, leave at least 10 cm space from the bottom of the TV set.
- Never install the TV set as follows:

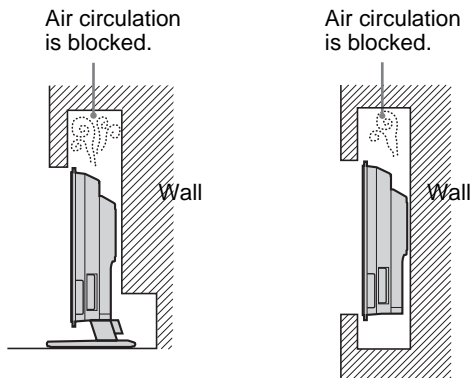

Ventilation holes

Do not insert anything in the ventilation holes. If metal or liquid is inserted in these holes, it may result in fire or electric shock.



Placement

- Never place the TV set in hot, humid or excessively dusty places.
- Do not install the TV set where insects may enter.
- Do not install the TV set where it may be exposed to mechanical vibration.
- Place the TV set on a stable, level surface. Otherwise, the TV set may fall and cause injury.
- Do not install the TV set in a location where it may protrude, such as on a behind a pillar or where you might bump your head on it. Otherwise, it may result in injury.



Water and moisture

- Do not use this TV set near water – for example, near a bathtub or shower room. Also do not expose to rain, moisture or smoke. This may result in fire or electric shock.
- Do not touch the mains lead and the TV set with set hands. Doing so may cause electric shock or damage to the TV set.



Moisture and flammable objects

- Do not let this TV set get wet. Never spill liquid of any kind on the TV set. If any liquid or solid object does fall through openings in the cabinet, do not operate the TV set. It may result in electric shock or damage to the TV set. Have it checked immediately by qualified service personnel.
- To prevent fire, keep flammable objects (candles, etc.) and electric bulbs away from the TV set.

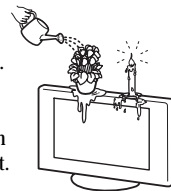

Oils

Do not install this TV set in restaurants that use oil. Dust absorbing oil may enter and damage the TV set.

Fall

Place the TV set on a secure, stable stand. Do not hang anything on the TV set. If you do, the TV set may fall from the stand or wall-mount bracket, causing damage or serious injury.

Do not allow children to climb on the TV set.



Vehicle or ceiling

Do not install this TV set in a vehicle. The motion of the vehicle may cause the TV set to fall down and cause injury. Do not hang this TV set from the ceiling.



Ships and other vessels

Do not install this TV set on a ship or other vessel. If the TV set is exposed to seawater, it may cause fire or damage the TV set.

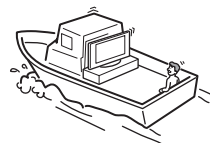

Outdoor use

- Do not expose the TV set to direct sunlight. The TV set may heat up and this may result in damage to the TV set.
- Do not install this TV set outdoors.



Wiring

- Unplug the mains lead when wiring cables. When hooking up, be sure to unplug the mains lead for your safety.
- Take care not to catch your feet on the cables. It may damage the TV set.

Cleaning

- Unplug the mains lead when cleaning the mains plug and this TV set. If you do not, it may result in electric shock.
- Clean the mains plug regularly. If the plug is covered with dust and it picks up moisture, its insulation may deteriorate and result in fire.



Lightning storms

For your own safety, do not touch any part of the TV set, mains lead, or aerial lead during lightning storms.



Continued

Damage requiring service

If the surface of the TV set cracks, do not touch it until you have unplugged the mains lead. Otherwise electric shock may result.

Servicing

Do not open the cabinet. Entrust the TV set to qualified service personnel only.



Small accessories removal and fittable

Keep accessories out of children's reach. If they are swallowed, choking or suffocation may occur. Call a doctor immediately.

Broken glass

Do not throw anything at the TV set. The screen glass may explode by the impact and cause serious injury.



When not in use

For environmental and safety reasons, it is recommended that the TV set is not left in standby when unused. Disconnect from the mains. However, some TV sets may have features which need the TV set to be left in standby to work correctly. The instructions in this manual will inform you if this applies.



Viewing the TV

- To view the TV comfortably, the recommended viewing position is from four to seven times the screen's vertical length away from the TV set.
- View the TV in moderate light, as viewing the TV in poor light strains your eyes. Watching the screen continuously for long periods of time can also strain your eyes.
- If the angle of the TV set is to be adjusted, steady the base of the stand with your hand to prevent the TV set from becoming separated from the stand. Be careful not to get your fingers caught between the TV set and the stand.

Volume adjustment

- Adjust the volume so as not to trouble your neighbours. Sound carries very easily at night time. Therefore, closing the windows or using headphones is suggested.
- When using headphones, adjust the volume so as to avoid excessive levels, as hearing damage may result.

Overloading

This TV set is designed to operate on a 220–240 V AC supply only. Take care not to connect too many appliances to the same mains socket as this could result in fire or electric shock.

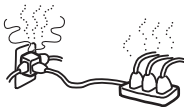

Heat

Do not touch the surface of the TV set. It remains hot, even after the TV set has been turned off for some time.

Corrosion

If you use this TV set near the seashore, salt may corrode metal parts of the TV set and cause internal damage or fire. It may also shorten the life of the TV set. Steps should be taken to reduce the humidity and moderate the temperature of the area where the TV set is located.

Precautions

LCD Screen

- Although the LCD screen is made with high-precision technology and 99.99% or more of the pixels are effective, black dots may appear or bright points of light (red, blue, or green) may appear constantly on the LCD screen. This is a structural property of the LCD panel and is not a malfunction.
- Do not expose the LCD screen surface to the sun. Doing so may damage the screen surface.
- Do not push or scratch the front filter, or place objects on top of this TV set. The image may be uneven or the LCD panel may be damaged.
- If this TV set is used in a cold place, a smear may occur in the picture or the picture may become dark. This does not indicate a failure. These phenomena disappear as the temperature rises.
- Ghosting may occur when still pictures are displayed continuously. It may disappear after a few moments.
- The screen and cabinet get warm when this TV set is in use. This is not a malfunction.
- The LCD contains a small amount of liquid crystal and mercury. The fluorescent tube used in this TV set also contains mercury. Follow your local ordinances and regulations for disposal.

Fluorescent lamp

This TV set uses a special fluorescent lamp as its light source. If the screen image becomes dark, flickers, or does not appear, the fluorescent lamp has worn out and the LCD screen should be replaced. For replacement, consult qualified service personnel.

Installing the TV set

- Do not install the TV set in places subject to extreme temperature, for example in direct sunlight, or near a radiator, or heating vent. If the TV set is exposed to extreme temperature, the TV set may overheat and cause deformation of the casing or cause the TV set to malfunction.
- The TV set is not disconnected from the mains when the TV set is switched off. To disconnect the TV set completely, pull the plug from the mains.
- To obtain a clear picture, do not expose the screen to direct illumination or direct sunlight. If possible, use spot lighting directed down from the ceiling.
- Do not install optional components too close to the TV set. Keep optional components at least 30 cm away from the TV set. If a VCR is installed in front of the TV set or beside the TV set, the picture may become distorted.
- Picture distortion and/or noisy sound may occur if the TV set is positioned in close proximity to any equipment emitting electromagnetic radiation.

Handling and cleaning the screen surface/cabinet of the TV set

The screen surface is finished with a special coating to prevent strong light reflections.

To avoid material degradation or screen coating degradation, observe the following precautions.

- Do not push on the screen, scratch it with a hard object, or throw anything at it. The screen may be damaged.
- Do not touch the display panel after operating the TV set continuously for a long period as the display panel becomes hot.
- We recommend that the screen surface be touched as little as possible.
- To remove dust from the screen surface/cabinet, wipe gently with a soft cloth. If dust is persistent, wipe with a soft cloth slightly moistened with a diluted mild detergent solution. You can wash and repeatedly use the soft cloth.
- Never use any type of abrasive pad, alkaline/acid cleaner, scouring powder, or volatile solvent, such as alcohol, benzene, thinner or insecticide. Using such materials or maintaining prolonged contact with rubber or vinyl materials may result in damage to the screen surface and cabinet material.
- The ventilation holes can accumulate dust over time. To ensure proper ventilation, we recommend removing the dust periodically (once a month) using a vacuum cleaner.

Disposal of the TV set

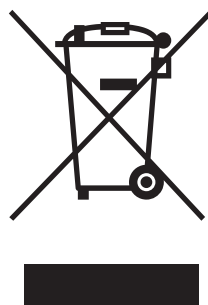

Disposal of Old Electrical & Electronic Equipment (Applicable in the European Union and other European countries with separate collection systems)

This symbol on the product or on its packaging indicates that this product shall not be treated as household waste. Instead it shall be handed over to the applicable collection point for the recycling of electrical and electronic equipment. By ensuring this product is disposed of correctly, you will help prevent potential negative consequences for the environment and human health, which could otherwise be caused by inappropriate waste handling of this product. The recycling of materials will help to conserve natural resources. For more detailed information about recycling of this product, please contact your local city office, your household waste disposal service or the shop where you purchased the product.

Overview of the remote

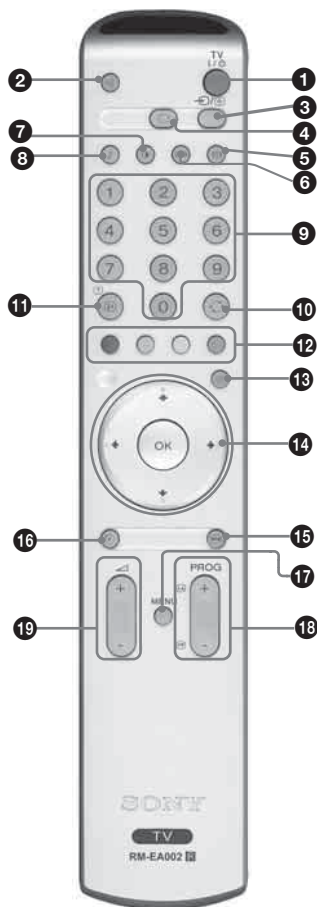

- 1 TV I/⏻ – TV standby**
Switches off the TV temporarily. The ⏻ (standby) indicator on the front of the TV lights up. Press again to switch on the TV from the standby mode.
- 2** – Mute (page 14)
- 3** / – Input select / Text hold
 - In TV mode (page 16): Selects the input source from equipment connected to the TV sockets.
 - In Text mode (page 15): Holds the current page.
- 4** – Return to normal TV mode
- 5** – Screen mode (page 15)
- 6 Power Saving (page 23)**
Reduces the power consumption of the TV.
- 7** – Picture mode (page 18)
- 8** – Sound effect (page 20)
- 9 Number buttons**
 - In TV mode: Selects channels. For channel numbers 10 and above, enter the second digit within two seconds.
 - In Text mode: Enters the three digit page number to select the page.
- 10** – Previous channel
Returns to the previous channel watched (for more than five seconds).
- 11** – Info / Text reveal
 - In TV mode: Displays information such as current channel number and screen mode.
 - In Text mode (page 15): Reveals hidden information (e.g., answers to a quiz).
- 12 Coloured buttons**
Text mode (page 15): Used for Fastext.
- 13** – Text (page 15)
- 14** (page 14, 16)
- 15** – Picture Freeze (page 15)
Freezes the TV picture.

- 16 Sleep Timer (page 25)**
Sets the TV to standby mode after a specified time period.
- 17 MENU (page 17)**
- 18 PROG +/- (page 14)**
 - In TV mode: Selects the next (+) or previous (-) channel.
 - In Text mode: Selects the next (+) or previous (-) page.
- 19** – Volume

Tip

The , PROG+, and number 5 buttons have tactile dots. Use the tactile dots as references when operating the TV.

Overview of the TV buttons and indicators

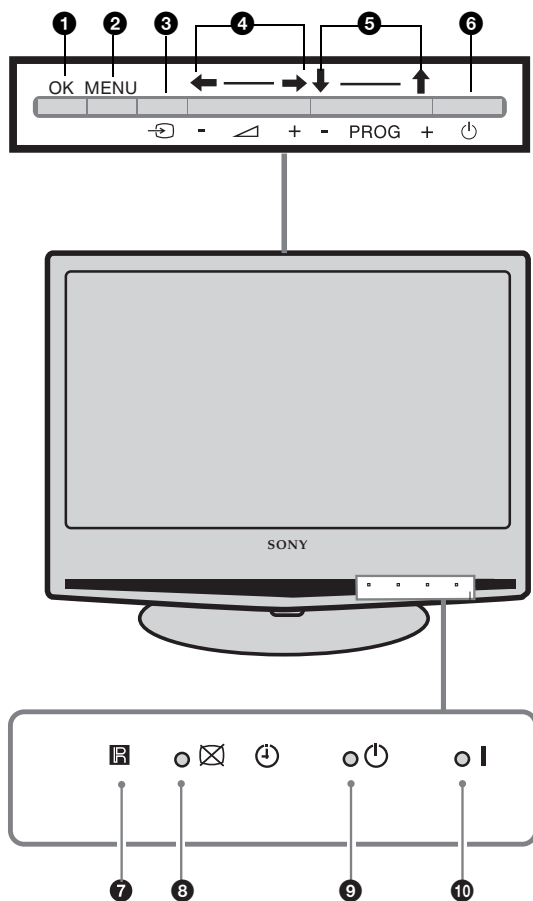

- 1 **OK**
- 2 **MENU** (page 17)
- 3 **Input select** (page 16)
Selects the input source from equipment connected to the TV sockets.
- 4 **+/-** **←/→**
 - Increases (+) or decreases (-) the volume.
 - In TV menu: Moves through the options left (←) or right (→).
- 5 **PROG +/-** **↑/↓**
 - In TV mode: Selects the next (+) or previous (-) channel.
 - In TV menu: Moves through the options up (↑) or down (↓).
- 6 **Power**
Switches the TV on or off.
- 7 **Remote control sensor**
- 8 **Sleep Timer** (page 25)/**Picture Off indicator** (page 23)
 - Lights up in amber when the "Sleep Timer" is set.
 - Lights up in green when "Picture Off" is set.
- 9 **Standby indicator**
Lights up in red when the TV is in standby mode.
- 10 **I - Power indicator**
Lights up in green when the TV is switched on.

1: Checking the accessories

Remote RM-EA002 (1)

Size AA batteries (R6 type) (2)

Mains Lead (1)



Bundling band (1) and screw (2)

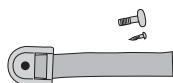

AC Power adapter (1)

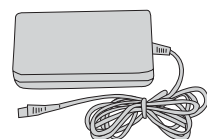

2: Inserting batteries into the remote

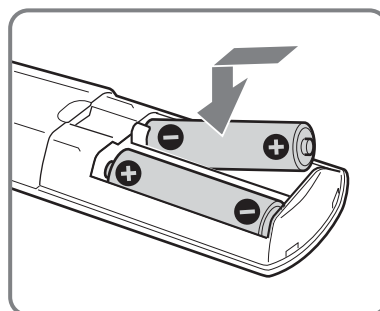
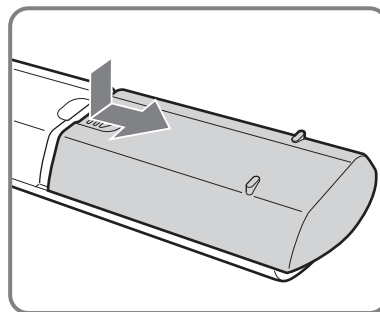

Notes

- Observe the correct polarity when inserting batteries.
- Dispose of batteries in an environmentally friendly way. Certain regions may regulate disposal of the battery. Please consult your local authority.
- Do not use different types of batteries together or mix old and new batteries.
- Handle the remote with care. Do not drop or step on it, or spill liquid of any kind onto it.
- Do not place the remote in a location near a heat source, or in a place subject to direct sunlight, or in a damp room.

3: Connecting an aerial/VCR

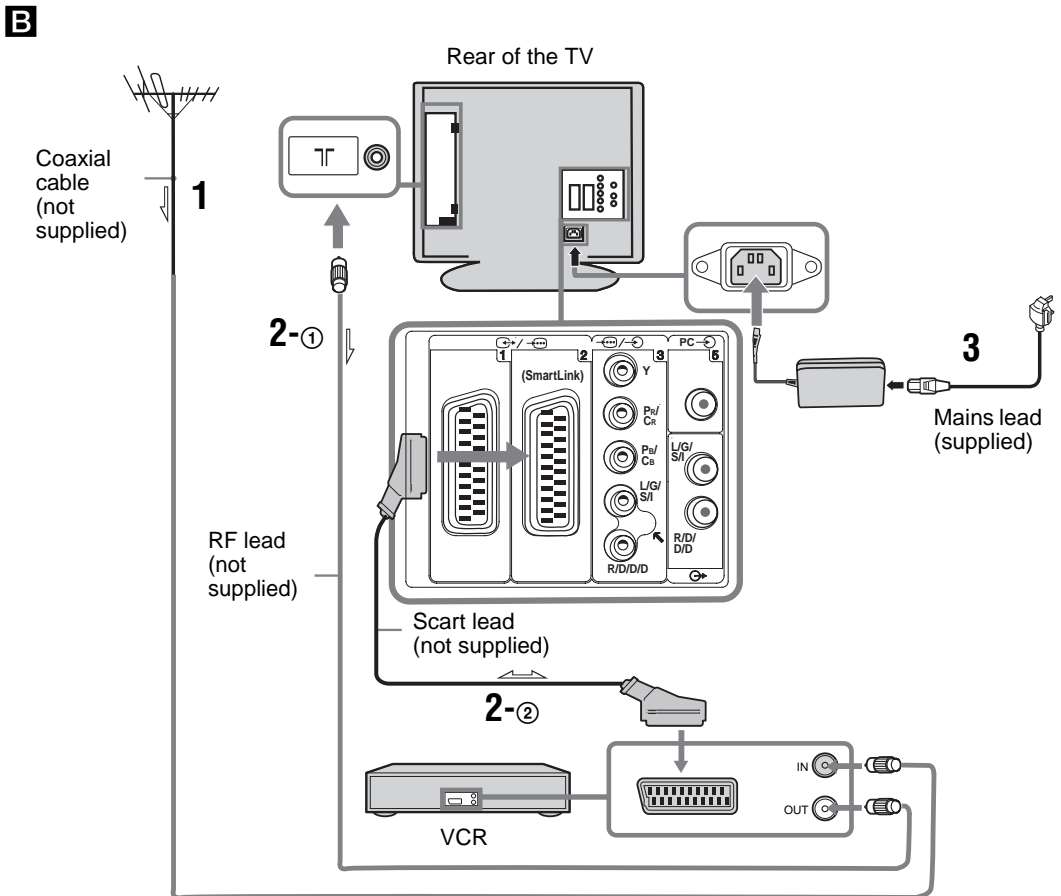
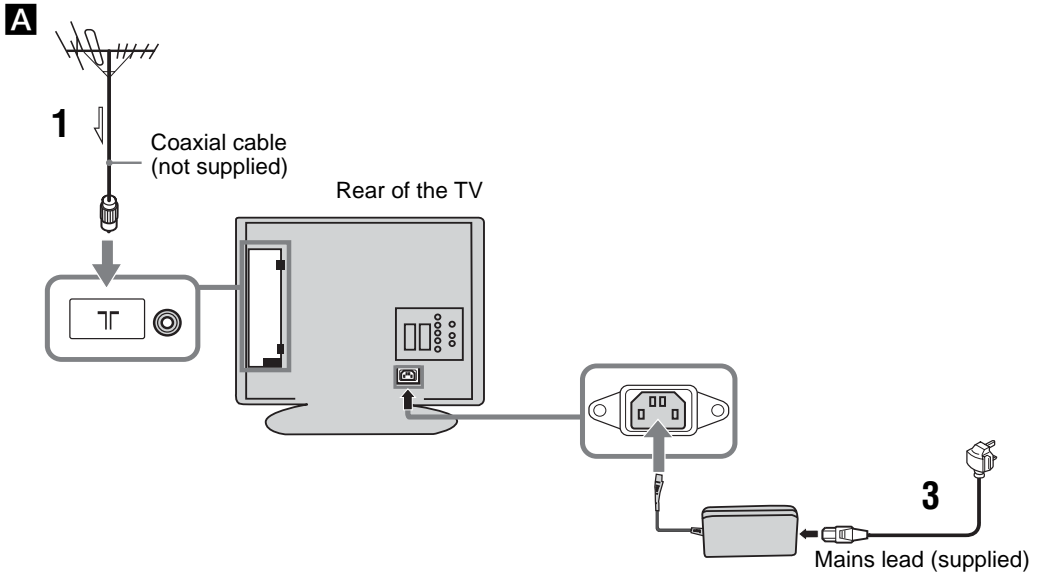

1 Connect your aerial with the coaxial cable.

If connecting to an aerial only (A)

Connect your aerial to the  socket on the rear of the TV, then go to step 3.

If connecting to a VCR with an aerial (B)

Connect your aerial to the input socket on your VCR.

2 Connect your VCR.

① Connect the output socket on your VCR to the  socket on the rear of the TV with the RF lead.

② Connect the scart socket on your VCR to the  scart socket on the rear of the TV with a scart lead.

3 Connect the supplied mains lead to the AC IN socket on the rear of the TV.

Note

Do not connect the mains lead to your mains socket until all connections are complete.

4 Bundle the cable.

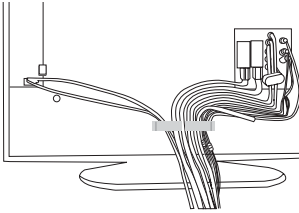

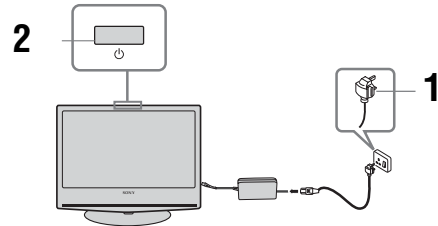

5: Switching on the TV



1 Connect the TV to your mains socket (220-240V AC, 50Hz).

2 Press  on the TV (Top side).

When you switch on the TV for the first time, the language menu appears on the screen, then go to "6: Selecting the language and country/region.

When the TV is in standby mode (the  (standby) indicator on the front of the TV is red), press TV  on the remote to switch on the TV.

4: Preventing the TV from toppling over

After all connections are completed, secure the TV.

1 Fasten the supplied support belt to the stand with a screw.

2 While supporting the TV, tighten the supplied support belt to adjust the length.

3 Fit the supplied support belt to the TV stand, then firmly fasten with the supplied screw using a screw driver or coin, etc.

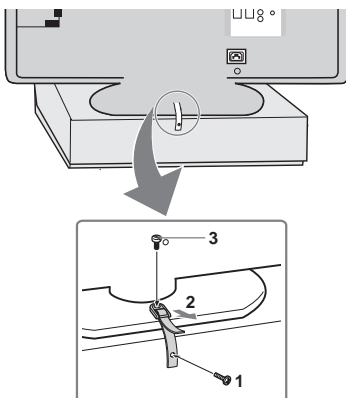

6: Auto-tuning the TV

After selecting the language and country/region, a message confirming the TV start auto-tuning appears on the screen.

You must tune the TV to receive channels (TV broadcasts). Do the following to search and store all available channels.

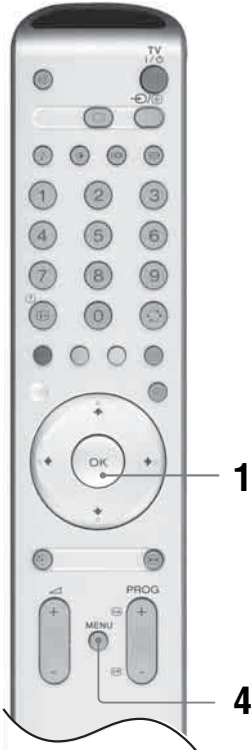

- 1 Press OK to select “Yes”.

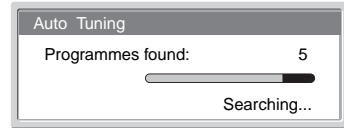
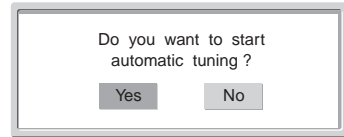

The TV starts searching for all available channels. This may take some time, please be patient and do not press any buttons on the TV or remote. Once all available channels have been stored, the TV returns to normal operation, displaying the channel stored on channel number 1.

When a message appears to confirm the aerial connections:

No channels are found. Check all the aerial connections and press OK twice to start auto-tuning again.

- 2 The Programme Sorting menu appears on the screen.
- 3 To change the order in which the channels are stored on the TV. See page 27.
- 4 Press MENU to exit.
The TV has now tuned in all the available channels.

Watching TV

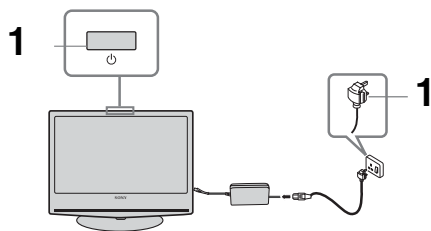

1 Press on the TV (Top side) to switch on the TV.

When the TV is in standby mode (the (standby) indicator on the front of the TV is red), press TV on the remote to switch on the TV.

2 Press the number buttons or PROG +/- to select a TV channel.

To select channel numbers 10 and above using the number buttons, enter the second digit within two seconds.

Additional operations

To	Do this
Turn off the TV temporarily (Standby mode)	Press TV .
Turn on the TV from Standby mode without sound.	Press . Press +/- to set the volume level.
Turn off the TV completely	Press on the top side of the TV.
Adjust the volume	Press + (increase) /- (decrease).
Mute the sound	Press . Press again to restore.
Return to the previous channel watched (for more than five seconds)	Press .
Access the Programme index table	Press OK. To select a channel, press /, then press OK.
To access the Input signal index table, see page 16	Press OK. Press to select the desired input signal, press /, then press OK.

To access Text

Press . Each time you press , the display changes cyclically as follows:

Text → Text over the TV picture (mix mode) → No Text (exit the Text service)

To select a page, press the number buttons or PROG +/-.

To hold a page, press / .

To reveal hidden information, press / .

Return to normal TV mode .

Tips

- Ensure that the TV is receiving a good signal, or some text errors may occur.
- Most TV channels broadcast a Text service. For information on the use of the service, select the index page (usually page 100).
- When four coloured items appear at the bottom of the Text page, Fastext is available. Fastext allows you to access pages quickly and easily. Press the corresponding coloured button to access the page.
- Whilst you are viewing Teletext, press repeatedly to choose between four different options of brightness.

Picture Freeze

Freezes the TV picture (e.g. to make a note of a telephone number or recipe).

- 1 Press on the remote control.
- 2 Press , , , to adjust the position of the window.
- 3 Press to remove the window.
- 4 Press again to return to normal TV mode.

change the screen mode manually to suit the broadcast

Press repeatedly to select Wide, Smart, 4:3, 14:9, or Zoom.

Wide

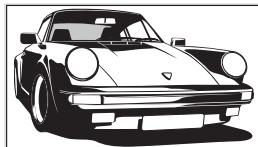

Displays wide screen (16:9) broadcasts in the correct proportions.

Smart*

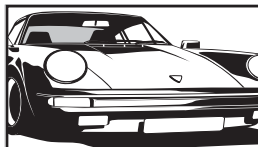

Displays conventional 4:3 broadcasts with an imitation wide screen effect. The 4:3 picture is stretched to fill the screen.

4:3

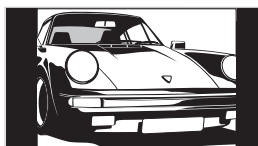

Displays conventional 4:3 broadcasts (e.g., non-wide screen TV) in the correct proportions. As a result, black border areas are visible on the screen.

14:9*

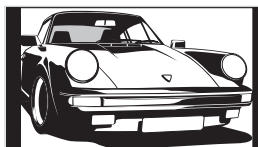

Displays 14:9 broadcasts in the correct proportions. As a result, black border areas are visible on the screen.

Zoom*

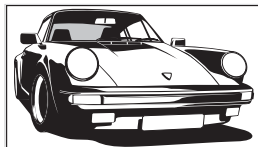

Displays cinemascope (letter box format) broadcasts in the correct proportions.

* Parts of the top and bottom of the picture may be cut off.

Tips

- Alternatively, you can set "Auto Format" to "On". If the broadcaster sends format information, the TV will automatically select the best mode to suit the broadcast (page 22).
- You can adjust the position of the picture when selecting Smart, 14:9, or Zoom. Press / to move up or down (e.g., to read subtitles).

Viewing pictures from connected equipment

Switch on the connected equipment, then perform one of the following operation.

For equipment connected to the scart sockets using a fully-wired 21-pin scart lead

Start playback on the connected equipment.

The picture from the connected equipment appears on the screen.

For an auto-tuned VCR (page 11)

Press PROG +/-, or the number buttons, to select the video channel. You can also press repeatedly until the correct input symbol (see below) appears on the screen.

For other connected equipment

Press repeatedly until the correct input symbol (see below) appears on the screen or press OK to access the Input signal index table. To select an input source, press /, then press OK.

1/1, 2/2:

Audio/video or RGB input signal through the scart socket /1 or 2. The symbol appears only if an RGB source has been connected.

3:

Component input signal through the Y, Pb/Cb, Pr/Cr sockets /3, and audio input signal through the L/G/S/I, R/D/D/D sockets /3.

4/S4:

Video input signal through the video socket 4, and audio input signal through the audio socket L/G/S/I (MONO), R/D/D/D sockets 4. S4 appears only if the equipment is connected to the S video socket S4 instead of the video socket 4, and S video input signal is input through the S video socket S4.

5:

RGB input signal through the PC connectors 5, and audio input signal through the socket .

Additional operations

To	Do this
Return to the normal TV operation	Press .
Access the Input Signal table	Press OK. To select an input source, press /, then press OK.

Using the Menu

Navigating through menus

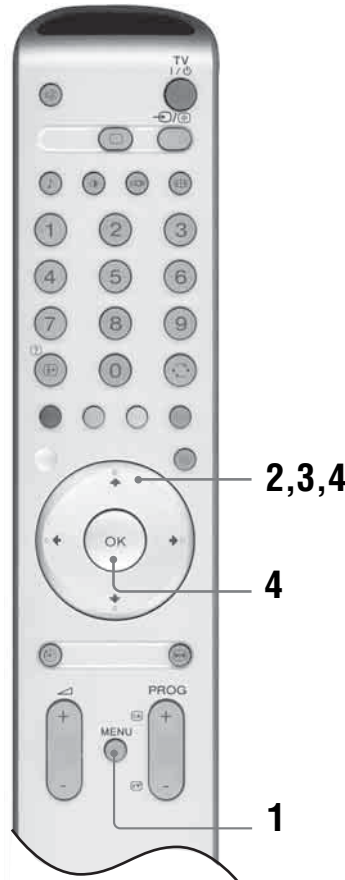

- 1 Press MENU to display the menu.
- 2 Press / to select a menu icon, then press .
- 3 Press / to select an option.
- 4 Press /// to change/set the setting, then press OK.
To exit the menu, press MENU.
To return to the last display, press .

Continued

Overview of the menus

The following options are available in each menu. For details on navigating through menus, see page 16. Also, see page in parentheses for details of each menu.

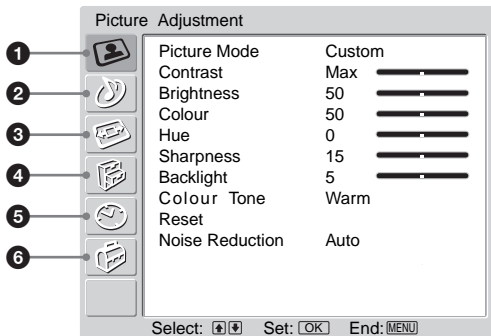

1 Picture Adjustment

- Picture Mode (18)
- Contrast/Brightness/Colour/Hue/Sharpness/Backlight (18)
- Colour Tone (18)
- Reset (19)
- Noise Reduction (19)

2 Sound Adjustment

- Sound Effect (20)
- Treble/Bass/Balance (20)
- Reset (20)
- Dual Sound (21)
- Auto Volume (21)

3 Screen

- Auto Format (22)
- Screen Format (22)
- RGB Center (22)

4 Features

- Power Saving (23)
- Light Sensor (23)
- AV2 Output (23)
- TV Speakers (24)
- PC Adjustment (24)

5 Timer

- Sleep Timer (25)

6 Set Up

- Auto Start Up (26)
- Auto Tuning (26)
- Programme Sorting (27)
- Programme Labels (27)
- AV Preset (28)
 - Label/Skip
- Manual Programme Preset (29)
 - Programme/Channel/Label/AFT/Audio Filter/Skip/Confirm

Picture Adjustment menu

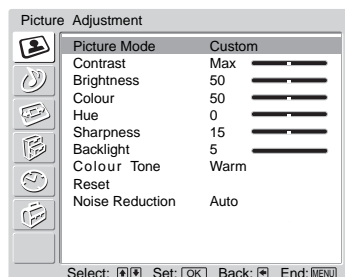

You can select the options listed below on the Picture Adjustment menu. To select options, see “Navigating through menus” (page 16).

Tip

When you set the “Picture Mode” option to “Vivid” or “Standard,” you can adjust only “Contrast,” and “Reset.”

Picture Mode

Selects the picture mode.

- 1 Press OK to select “Picture Mode”.
- 2 Press ↓/↑ to select one of the following picture modes, then press OK.
 - Vivid: For big lighted spaces.
 - Standard: Optimal picture for home use.
 - Custom: Allows you to store your own preferred settings.

Tip

You can change the picture mode by pressing  repeatedly.

Contrast/Brightness/Colour/Hue/Sharpness/Backlight

- 1 Press OK to select the option.
- 2 Press ←/→ to set the level, then press OK.

Tip

“Hue” can only be adjusted for an NTSC colour signal (e.g., U.S.A. video tapes). “Brightness”, “Colour”, “Hue”, “Sharpness” and “Backlight” only appear and can be adjusted if “Picture Mode” is set to “Custom”.

Colour Tone

- 1 Press OK to select “Colour Tone”.
- 2 Press ↓/↑ to select one of the following, then press OK.

- Cool: Gives the white colours a blue tint.
- Neutral: Gives the white colours a neutral tint.
- Warm: Gives the white colours a red tint.

Tip

“Warm” only appears and can be adjusted if “Picture Mode” is set to “Custom”.

Continued

Reset

Reset all the picture settings to the factory settings.

- 1 Press OK to select “Reset”.
- 2 Press ↓/↑ to select “OK,” then press OK.

Noise Reduction

Reduces the picture noise (snowy picture) in a weak broadcast signal.

- 1 Press OK to select “Noise Reduction”.
- 2 Press ↓/↑ to select “Auto”, then press OK.

Sound Adjustment menu

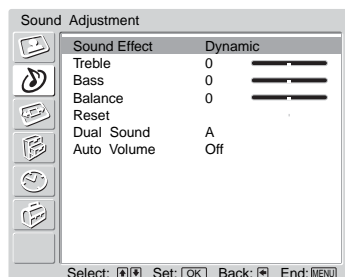

You can select the options listed below on the Sound Adjustment menu. To select options, see “Navigating through menus” (page 16).

Sound Effect

- 1 Press OK to select “Sound Effect”.
- 2 Press ↓/↑ to select one of the following sound effects, then press OK.
 - Natural: Enhances clarity, detail, and sound presence by using “BBE High definition Sound System”^{*1}.
 - Dynamic: Intensifies clarity and sound presence for better intelligibility and musical realism by using the “BBE High definition Sound System.”
 - Dolby Virtual^{™2}: Uses the TV speakers to simulate the surround effect produced by a multi channel system.
 - Off: Flat response.

Tips

- You can change sound effect by pressing ♪ repeatedly.
- If you set “Auto Volume” to “On”, “Sound Effect” changes to “Natural”.

^{*1} Licensed by BBE Sound, Inc. under USP4638258, 4482866. “BBE” and BBE symbol are trademarks of BBE Sound, Inc.

^{*2} Manufactured under license from Dolby Laboratories. “Dolby” and the double-D symbol  are trademarks of Dolby Laboratories.

Treble/Bass/Balance

Adjusts higher-pitched sounds (Treble), adjusts lower-pitched sounds (Bass), and emphasizes left or right speaker balance (Balance).

- 1 Press OK to select the option.
- 2 Press ←/→ to set the level, then press OK.

Reset

Resets the “Treble,” “Bass” and “Balance” settings to the factory settings.

- 1 Press OK to select “Reset”.
- 2 Press ↓/↑ to select “OK,” then press OK.

Continued

Dual Sound

Selects the sound from the speaker for a stereo or bilingual broadcast.

1 Press OK to select “Dual Sound”.

2 Press ↓/↑ to select one of the following, then press OK.

- Stereo/Mono: For a stereo broadcast.
- A/B/Mono: For a bilingual broadcast, select “A” for sound channel 1, “B” for sound channel 2, or “Mono” for a mono channel, if available.

Tip

If you select other equipment connected to the TV, set “Dual Sound” to “Stereo,” “A” or “B.”

Auto Volume

Keeps a constant volume level even when volume level gaps occur (e.g., adverts tend to be louder than programmes).

1 Press OK to select “Auto Volume”.

2 Press ↓/↑ to select “On,” then press OK.

Tip

If you set “Sound Effect” to “Dolby Virtual”, “Auto Volume” will automatically be switched to “Off”.

Screen menu

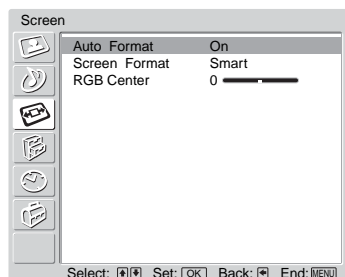

You can select the options listed below on the Screen Control menu. To select options, see “Navigating through menus” (page 16).

Auto Format

Automatically changes the screen format according to the broadcast signal.

- 1 Press OK to select “Auto Format”.
- 2 Press ↓/↑ to select “On,” then press OK.

Tips

- Even if you have selected “On” or “Off” in “Auto Format”, you can always modify the format of the screen by pressing  repeatedly.
- “Auto Format” is available for PAL and SECAM signals only.

Screen Format

For details about the screen format, see page 15.



- 1 Press OK to select “Screen Format”.
- 2 Press ↓/↑ to select “Wide,” “Smart,” “4:3,” “14:9” or “Zoom” (see page 16 for details), then press OK.

RGB Center

Adjusts the horizontal picture position so that the picture is in the middle of the screen.

- 1 Press OK to select “RGB Center”.
- 2 Press ←/→ to adjust the centre of the picture between -5 and +5, then press OK.

Tip

This option is only available if an RGB source has been connected to the Scarts connectors  1 or  2 on the rear of the TV.

Features menu

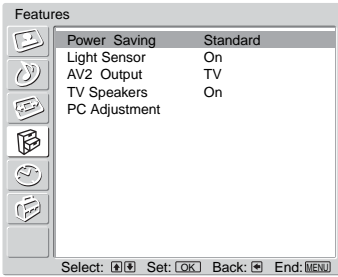

You can select the options listed below on the Features menu. To select options, see “Navigating through menus” (page 16).

Power Saving



- 1 Press OK to select “Power Saving”.
- 2 Press ↓/↑ to select one of the following, then press OK.
 - Standard: Default settings.
 - Reduce: Reduces the power consumption of the TV.
 - Picture Off: Switches off the picture. You can listen to the sound with the picture off.



Light Sensor

Automatically optimizes the picture settings according to the ambient light in the room.

- 1 Press OK to select “Light Sensor”.
- 2 Press ↓/↑ to select “On” then press OK.

AV2 Output

Sets a signal to be output through the socket labelled  on the rear of the TV. If you connect a VCR to the  socket, you can then record from the equipment connected to other sockets of the TV.

- 1 Press OK to select “AV2 Output”.
- 2 Press ↓/↑ to select one of the following, then press OK.
 - TV: Outputs broadcast from the aerial.
 - AV1: Outputs signals from equipment connected to the  socket.
 - AV4: Outputs signals from equipment connected to the  socket.
 - Auto: Outputs whatever is being viewed on the screen.

TV Speakers

Turns off the TV speakers e.g. to listen to the sound through external audio equipment connected to the TV.

- 1 Press OK to select “TV Speakers”.
- 2 Press ↓/↑ to select one of the following, then press OK.
 - On: the sound is output from the TV speakers.
 - One Time Off: the TV speakers are temporarily turned off allowing you to listen to the sound from external audio equipment.

Tip

The “TV speakers” option automatically returns to “On” when the TV set is switched off.

- Permanent Off: the TV speakers are permanently turned off allowing you to listen to the sound from external audio equipment.

Tip

To turn on the TV speakers again, change to on.

PC Adjustment

Customizes the TV screen as a PC monitor.

- 1 Press OK to select “PC Adjustment”.
- 2 Press ↓/↑ to select one of the following, then press OK.
 - Phase: Adjust the screen when a part of a displayed text or image is not clear.
 - Pitch: Enlarges or shrinks the screen size horizontally.
 - H Center: Moves the screen to the left or to the right.
 - V Center: Moves the screen up or down.
 - Power saving: Turns to standby mode if no PC signal is received.
 - Reset: Resets to the factory settings.

Tip

This option is only available if you are in PC Mode.

Timer menu

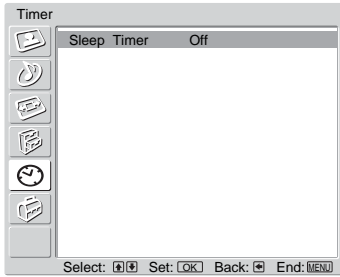

You can select the options listed below on the Timer menu. To select options, see “Navigating through menus” (page 16).

Sleep Timer

Sets a period of time after which the TV automatically switches itself into the standby mode.

- 1 Press OK to select “Sleep Timer”.
- 2 Press ↓/↑ to select the desired time period (“30min”/“60min”/“90min”/“120min”), then press OK.

The ⌚ indicator on the TV (front) lights up in amber.

Tips

- If you switch off the TV and switch it on again, “Sleep Timer” is reset to “Off.”
- “Sleep timer will end soon. Power will be turned off.” appears on the screen one minute before the TV switches to the standby mode.
- If you press ⏸/? , the remaining time in minutes before the TV switches to the standby mode is displayed on the screen.

Set Up menu

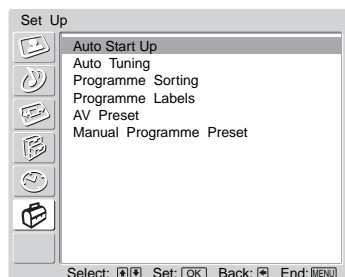

You can select the options listed below on the Set Up menu. To select options, see “Navigating through menus” (page 16).

Auto Start Up

Starts the “first time operation menu” to tune in all the available channels. Usually you do not need to do this operation because the channels are already tuned when the TV was first installed (page 13). However, this option allows you to repeat the process (e.g., to retune the TV after moving house, or to search for new channels that have been launched by broadcasters).

- 1 Press OK to select “Auto Start Up”.
- 2 Press **↑/↓/←/→** to select the language, then press OK.
- 3 Press **↑/↓** to select the country/region in which you will operate the TV, then press OK.
- 4 Press OK to select “Yes.”
The auto-tune display appears on the screen.
- 5 Follow steps 1 to 4 of “Auto-tuning the TV” (page 13).

Auto Tuning

Tunes in all the available channels.

Usually you do not need to do this operation because the channels are already tuned when the TV was first installed (page 13). However, this option allows you to repeat the process (e.g., to retune the TV after moving house, or to search for a new channels that have been launched by broadcasters).

- 1 Press OK to select “Auto Tuning”.
- 2 Follow step 1 and 2 of “Auto-tuning the TV” (page 13).
When all available analogue channels have been tuned, the TV returns to normal operation.

Continued

Programme Sorting

Changes the order in which the channels are stored on the TV.

- 1 Press OK to select “Programme Sorting”.
- 2 Press **↑/↓** to select the channel you want to move to a new position, then press OK.
- 3 Press **↑/↓** to select the new position for your channel, then press OK.
Repeat the procedure in steps 2 and 3 to move other channels if required.

Programme Labels

Assigns a channel name of your choice up to five letters or numbers. The name will be displayed briefly on the screen when the channel is selected. (Names for channels are usually taken automatically from Analogue Text (if available).)

- 1 Press OK to select “Programme Labels”.
- 2 Press **↑/↓** to select the channel you want to name, then press OK.
- 3 Press **↑/↓/←/→** to select the desired letter or number (“□” for a blank space), then press OK.

If you input a wrong character

Press **↑/↓/←/→** to select **⊞/⊞** and press OK repeatedly until the wrong character is selected. Then, press **↑/↓/←/→** to select the correct character and press OK.

- 4 Repeat the procedure in step 3 until the name is complete.
- 5 Press **↑/↓/←/→** to select “End,” then press OK.

AV Preset

Do the following options.

- 1 Press OK to select “AV Preset”.
- 2 Press **↑/↓** to select the desired input source, then press OK.
- 3 Press OK. Then press **↑/↓** to select the desired option below, then press OK.

Option	Description
Label	<p>Assigns a name to any equipment connected to the side and rear sockets. The name will be displayed briefly on the screen when the equipment is selected.</p> <p>Press ↑/↓ to select one of the following, then press OK. AV1 (or AV2/AV3/AV4/PC/HDMI) VIDEO/DVD/CABLE/ GAME/CAM/SAT: Uses one of these preset labels.</p> <p>Edit: Creates your own label. Follow steps 3 through 5 of Programme Labels (page 27).</p> <p>Skip: Skips an input source that is not connected to any equipment when you press ↑/↓ to select the input source. After selecting this option, press OK.</p> <p>Sound Offset: Sets an independent volume level to each equipment connected to the TV. Press → to select “Sound Offset”, then press OK. Press ↑/↓ to select the desired volume level.</p>

Continued

Manual Programme Preset

- 1 Press OK to select “Manual Programme Preset”.

Before selecting “Label”/“AFT”/“Audio Filter”/“Skip”/“Decoder”, press PROG +/- to select the programme number with the channel. You cannot select a programme number that is set to skip (page 30).

- 2 Press \uparrow/\downarrow to select one of the following options, then press OK.

Option	Description
Programme	<p>Presets programme channels manually.</p> <ol style="list-style-type: none"> 1 Press \uparrow/\downarrow to select “Programme”, then press OK. 2 Press \uparrow/\downarrow to select the programme number you want to manually tune (if tuning a VCR, select channel 0), then press \leftarrow.
Channel	<ol style="list-style-type: none"> 3 Press \uparrow/\downarrow to select “Channel”, then press OK. 4 Press \uparrow/\downarrow to select “S” (for cable channels) or “C” (for terrestrial channels), then press \rightarrow. 5 Tune the channels as follows: <p>If you do not know the channel number (frequency) Press \uparrow/\downarrow to search for the next available channel. When a channel has been found, the search will stop. To continue searching, press \uparrow/\downarrow.</p> <p>If you know the channel number (frequency) Press the number buttons to enter the channel number of the broadcast you want or your VCR channel number.</p> 6 Press OK. 7 Press OK to select “Confirm”, then press OK. <p>Repeat the procedure above to preset other channels manually.</p>

Option	Description
Label	<p>Assigns a name of your choice, up to five letters or numbers, to the selected channel. This name will be displayed briefly on the screen when the channel is selected.</p> <ol style="list-style-type: none"> 1 Follow steps 3 to 5 of "Programme Labels" (page 27). 2 Press OK to select "Confirm", then press OK.
AFT	<p>Fine-tunes the selected programme number manually if you feel that a slight tuning adjustment will improve the picture quality. (Normally, fine tuning is performed automatically.)</p> <ol style="list-style-type: none"> 1 Press ↑/↓ to adjust the fine tuning over a range of -15 to +15, then press OK. 2 Press OK twice. <p>To restore automatic fine tuning, select "On" in step 1.</p>
Audio Filter	<p>Improves the sound for individual channels in the case of distortion in mono broadcasts. Sometimes a non-standard broadcast signal can cause sound distortion or intermittent sound muting when watching mono programmes.</p> <ol style="list-style-type: none"> 1 Press ↑/↓ to select "Low" or "High", then press OK. If you do not experience any sound distortion, we recommend that you leave this option set to the factory setting "Off". 2 Press OK to select "Confirm", then press OK. <p>Note You cannot receive stereo or dual sound when "Low" or "High" is selected.</p>
Skip	<p>Skips unused channels when you press PROG +/- to select channels. (You can still select a skipped channel using the number buttons.)</p> <ol style="list-style-type: none"> 1 Press ↑/↓ to select "Yes", then press OK. 2 Press OK to select "Confirm", then press OK. <p>To restore a skipped channel, select "No" in step 1.</p>

Continued

Connecting optional equipment

You can connect a wide range of optional equipment to your TV. Connecting cables are not supplied.

Connecting to the side of the TV

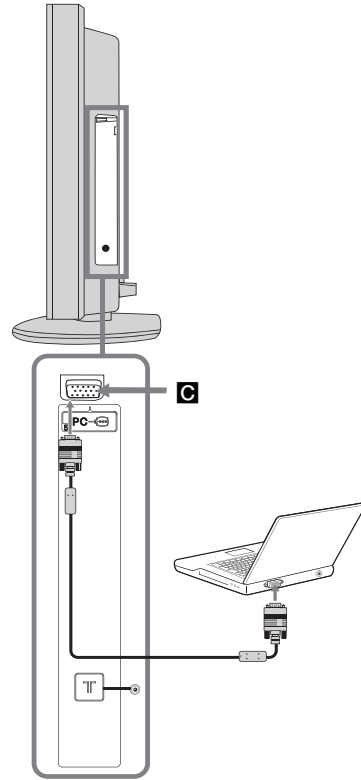
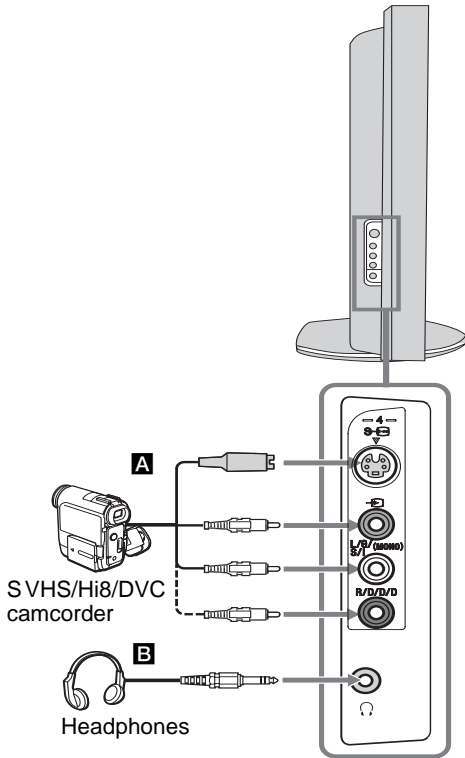





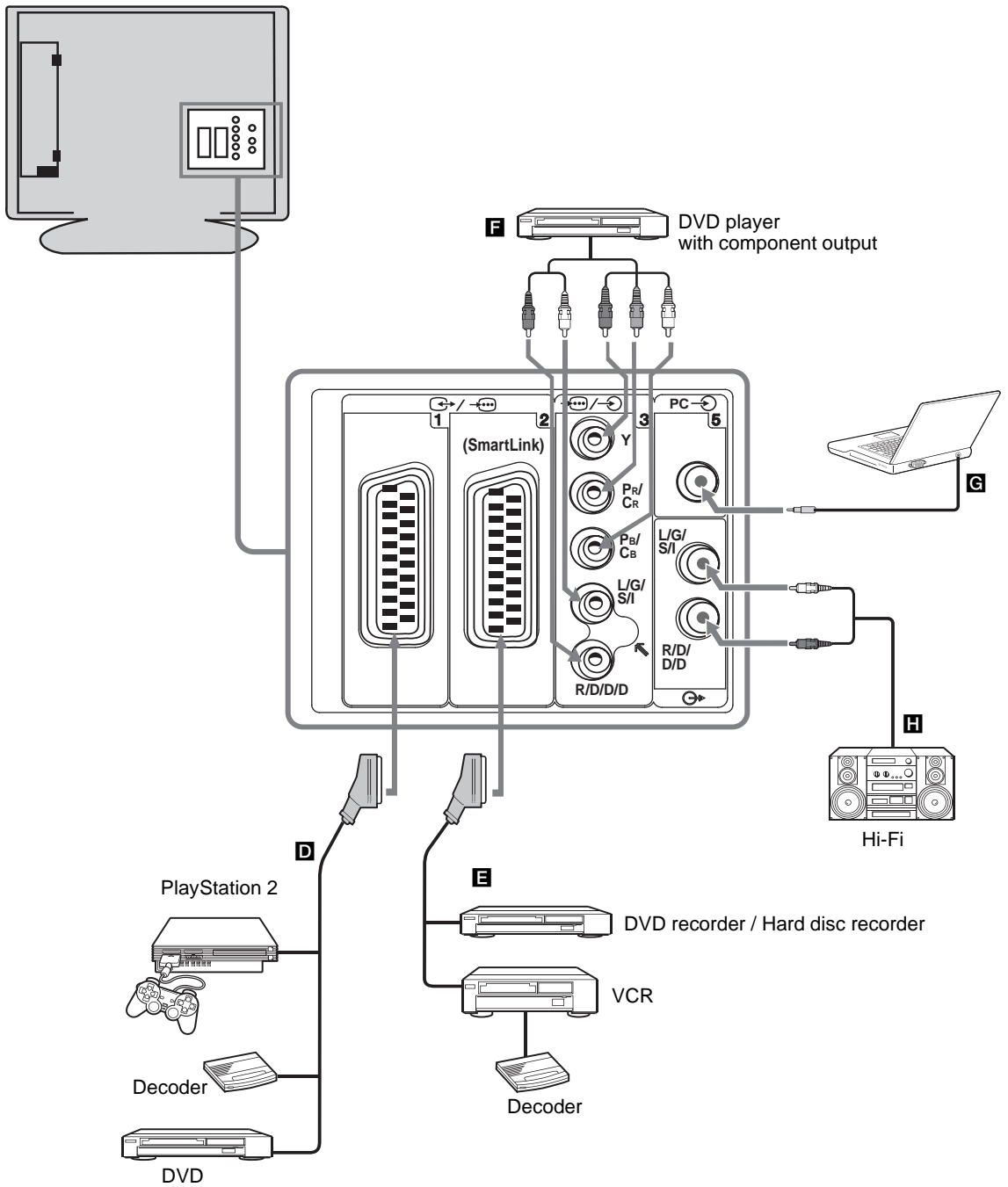

To connect	Do this
S VHS/Hi 8/DVC camcorder A	Connect to the S video socket $\text{S} \rightarrow 4$ or the video socket $\rightarrow 4$, and the audio sockets $\rightarrow 4$. To avoid picture noise, do not connect the camcorder to the video socket $\rightarrow 4$ and the S video socket $\text{S} \rightarrow 4$ at the same time. If you connect mono equipment, connect to the L/G/S/I sockets $\rightarrow 4$, and set "Dual Sound" to "A" (page 21).
Headphones B	Connect to the R/D/D/D socket to listen to sound from the TV on headphones.

To connect	Do this
Personal Computer C	Connect to the PC Input socket $\rightarrow 5$ and the audio socket C \rightarrow on the rear of the TV (page 32).

Connecting to the rear of the TV



To connect	Do this
"PlayStation 2", DVD player or decoder D	Connect to the scart socket   1. When you connect the decoder, the scrambled signal from the TV tuner is output to the decoder, then the unscrambled signal is output from the decoder.
DVD recorder or VCR that supports SmartLink E	Connect to the scart socket   2. SmartLink is a direct link between the TV and a VCR/DVD recorder. For more information on SmartLink, refer to the instruction manual supplied with your VCR or DVD recorder.
DVD player with component output F	Connect to the component socket  3 and the audio sockets  3. The component signal containing 576p signal format and audio signal are input from the DVD player.
Personal Computer G	See page 31.
Hi-Fi audio equipment H	Connect to the audio output sockets  to listen to the sound from the TV on Hi-Fi audio equipment. To turn off the sound of the TV speakers, go to "TV Speakers" on page 24.

Specifications

Display Unit

Power Requirements:

220–240 V AC, 50 Hz

Screen Size:

19 inches

Display Resolution (horizontal x vertical):

1280 dots x 768 lines

Power Consumption:

56 W

Standby Power Consumption:

1 W

Dimensions (w × h × d):

Approx. 468 x 402 x 218 mm (with stand)

Approx. 468 x 364 x 84 mm (without stand)

Weight:

Approx. 10,5 kg (with stand)

Approx. 7 kg (without stand)

Panel System

LCD (Liquid Crystal Display) Panel

TV System

I.

Colour System

PAL, SECAM

NTSC 3.58, 4.43 (only Video In)











Aerial



75 ohm external terminal for VHF/UHF

Channel Coverage

I: UHF B21–B69

Terminals

- AV1:  /  1
21-pin Scart connector (CENELEC standard) including audio/video input, RGB input, and TV audio/video output.
- AV2:  /  2 (SMARTLINK)
21-pin Scart connector (CENELEC standard) including audio/video input, RGB input, selectable audio/video output, and SmartLink interface
- AV3:  3
Y: 1 Vp-p, 75 ohms, 0.3V negative sync
PB: 0.7 Vp-p, 75 ohms
PR: 0.7 Vp-p, 75 ohms
 3 Audio input (phono jacks)
500 mVrms
Impedance: 47 kilo ohms
- AV4:  4S video input (4-pin mini DIN)
 4 Video input (phono jack)
 4 Audio input (phono jacks)
- AV5:  5
PC Input (15 Dsub) (see page 35)
G: 0.7 Vp-p, 75 ohms, non Sync on Green
B: 0.7 Vp-p, 75 ohms, non Sync on Green
R: 0.7 Vp-p, 75 ohms, non Sync on Green
HD: 1-5 Vp-p
VD: 1-5 Vp-p
 PC audio input: minijack.

-  Audio output (Left/Right) (phono jacks)
-  Headphones jack

Sound Output

5 W + 5 W (RMS)

Supplied Accessories

- Remote RM-EA002 (1)
- Size AA batteries (R6 type) (2)
- Support belt (1) and screw (2)
- AC power adapter (1)
- Mains Lead (1)

Optional Accessories

- Wall-Mount Bracket SU-WL11

Note

Remove Hinge Cover (cover for bundling the cables) before removing Table Top Stand from the rear of the TV (SU-WL11 Wall Mount Bracket instructions, Page 7, step 4, point 1).

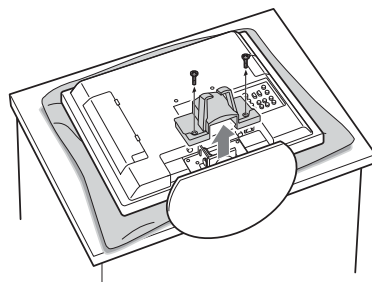

Design and specifications are subject to change without notice.

PC Specifications

Signals	Horizontal (Pixel)	Vertical (Line)	Horizontal frequency (kHz)	Vertical frequency (Hz)	Standard
VGA	640	480	31.5KHz	60Hz	VGA
	640	480	37.9KHz	72Hz	VESA
	640	480	37.5KHz	75Hz	VESA
	720	400	31.47KHz	70Hz	VGA-T
SVGA	800	600	35.1KHz	56Hz	VESA Guidelines
	800	600	37.9KHz	60Hz	VESA Guidelines
	800	600	48.1KHz	72Hz	VESA
	800	600	46.9KHz	75Hz	VESA
XGA	1024	768	48.4KHz	60Hz	VESA Guidelines
	1024	768	56.5KHz	70Hz	VESA
	1024	768	60.0KHz	75Hz	VESA
WXGA	1280	768	47.40KHz	60Hz	VESA
	1280	768	47.78KHz	60Hz	VESA

This TV does not support Sync on Green or Composite Sync.



If a signal other than in the above chart is input, it may not be displayed properly or may not be displayed as you set. Using the Vertical frequency (Hz) of the personal computer at 60 is recommended.

Troubleshooting

Check whether the  (standby) indicator is flashing in red.

When it is flashing





The self-diagnosis function is activated.



- 1 Measure how long the  (standby) indicator flashes and stops flashing.
For example, the indicator flashes for two seconds, stops flashing for one second, and flashes for two seconds.
- 2 Press  on the TV (top side) to switch it off, disconnect the mains lead, and inform your dealer or Sony service centre of how the indicator flashes (duration and interval).

When it is not flashing



- 1 Check the items in the tables below.
- 2 If the problem still persists, have your TV serviced by qualified service personnel.

Picture

Problem	Cause/Remedy
No picture (screen is dark) and no sound	<ul style="list-style-type: none"> • Check the aerial connection. • Connect the TV to the mains, and press  on the TV (top side). • If the  (standby) indicator lights up in red, press TV .
No picture or no menu information from equipment connected to the scart connector	<ul style="list-style-type: none"> • Check that the optional equipment is on and press / repeatedly until the correct input symbol is displayed on the screen. • Check the connection between the optional equipment and the TV.
Distorted picture	<ul style="list-style-type: none"> • When installing optional equipment, leave some space between the optional equipment and the TV. • When changing programmes or selecting Text, turn off any equipment connected to the scart connector on the rear of the TV.
Double images or ghosting	<ul style="list-style-type: none"> • Check aerial/cable connections. • Check the aerial location and direction.
Only snow and noise appear on the screen	<ul style="list-style-type: none"> • Check if the aerial is broken or bent. • Check if the aerial has reached the end of its serviceable life (three to five years in normal use, one to two years at the seaside).
Picture (dotted lines or stripes) noise	<ul style="list-style-type: none"> • Keep the TV away from electrical noise sources such as cars, motorcycles, or hair-dryers. • Make sure that the aerial is connected using the supplied coaxial cable. • Keep the aerial cable away from other connecting cables. • Do not use a 300-ohm twin lead cable as interference may occur.
Picture noise when viewing a TV channel	<ul style="list-style-type: none"> • Select “Manual Programme Preset” in the “Set Up” menu and adjust “AFT” (Automatic Fine Tuning) to obtain better picture reception (page 29). • Select “Noise Reduction” in the “Picture Adjustment” menu to reduce the noise in the picture (page 19).
Stripe noise during playback/recording of a VCR	<ul style="list-style-type: none"> • Video head interference. Keep your VCR away from the TV. • Leave a space of 30 cm between your VCR and the TV to avoid noise. • Avoid installing your VCR in front of the TV or beside the TV.
Some tiny black points and/or bright points on the screen	<ul style="list-style-type: none"> • The picture of a display unit is composed of pixels. Tiny black points and/or bright points (pixels) on the screen do not indicate a malfunction.

Problem	Cause/Remedy
No colour on programmes	<ul style="list-style-type: none"> • Select “Reset” in the “Picture Adjustment” menu to return to the factory settings (page 19).
No colour or irregular colour when viewing a signal from the Y, PB/CB, PR/CR jacks of  3	<ul style="list-style-type: none"> • Check the connection of the Y, PB/CB, PR/CR jacks of 3. • Make sure that the Y, PB/CB, PR/CR jacks of 3 are firmly seated in their respective sockets.

Sound

Problem	Cause/Remedy
No sound, but good picture	<ul style="list-style-type: none"> • Press  +/- or  (Mute). • Check that “TV Speakers” is set to “on” in the “Features” menu (page 24).
Noisy sound	<ul style="list-style-type: none"> • See the “Picture noise” causes/remedies on page 36.

General

Problem	Cause/Remedy
The TV turns off automatically (the TV enters standby mode)	<ul style="list-style-type: none"> • If no signal is received or no operation is performed in the TV mode for 10 minutes, the TV automatically switches to standby mode.
Some input sources cannot be selected	<ul style="list-style-type: none"> • Select “AV Preset” in the “Set Up” menu and cancel “Skip” of the input source (page 30).
The remote does not function	<ul style="list-style-type: none"> • Replace the batteries.
Wrong characters appear when viewing the menu/Text	<ul style="list-style-type: none"> • Select “Language” and “Country” in the “Set Up” menu and set the language and country/region in which Text is provided (page 26). For Cyrillic languages, we recommended that you select Russia if your own country/region does not appear in the list.

Index

Numerics

0-9 buttons 8

14:9 15

4:3 15

A

Accessories supplied 10

Aerial, connecting 11

AFT 29

Audio Filter 30

Auto Format 22

Auto Start Up 26

Auto Tuning 13, 27

Auto Volume 21

Auto-tuning 13

AV Preset 28

AV2 Output 23

B

Backlight 18

Balance 20

Bass 20

Batteries, inserting into the remote 10

BBE 20

Brightness 18

C

Channel 29

Channels

 auto-tuning 13

 selecting 14

 Skip 30

Checking the accessories 10

Colour 18

Colour Tone 18

Coloured buttons 8

Connecting 11

 an aerial/VCR 11

 optional equipment 31

Contrast 18

D

Dolby Virtual 20

Dual Sound 21

F

Fastext 15

Features menu 23

H

Headphones

 connecting 31

Hue 18

I

Info (i) button 8

Input select (↔) button 8, 9

Input signal index table 16

L

Label 29

Light Sensor 23

M

Manual Programme Preset 28

MENU button 8, 9

Mute (⊗) button 8

N

Noise Reduction 19

Number buttons 8

O

OK button 8, 9

Overview 8

Overview of the remote 8

P

PC Adjustment 24

Picture Adjustment menu 18

Picture Freeze 8

Picture Mode 18

Picture mode (⊙) button 8

Picture Off indicator 9

Power (I) indicator 9

Power Saving 8, 23

Previous channel 8

PROG +/- buttons 8, 9

Programme 29

Programme index table 14

Programme Labels 27

Programme Sorting 27

R

Remote

 inserting batteries 10

 overview 8

 sensor 9

Reset

 picture adjustment 19

 sound adjustment 20

RGB Center 22

S

Screen Format 22

Screen menu 22

Screen mode 15

Screen mode (⊞) button 8

Set Up menu 26

Sharpness 18

Skip 30

Sleep Timer 8, 25

Smart 15

Sound Adjustment menu 20

Sound Effect 20

Sound effect (J) button 8

Specifications 34, 35

Standby (⏻) indicator 9

Standby (⏻) button 8

T

Text 15

Text (≡) button 8, 38

Text hold (⊞) button 8

Text reveal (⊞) button 8

Timer (⌚) indicator 9

Timer menu 25

Treble 20

TV mode (□) button 8

TV Speakers 24

TV (I) button 8

V

VCR

 connecting 11

Volume (↔) +/- buttons 8, 9

W

Wide 15

Z

Zoom 15