

LCD Digital Color TV

Setup Guide (Operating Instructions)

Setting up your TV

To watch TV

Additional Information

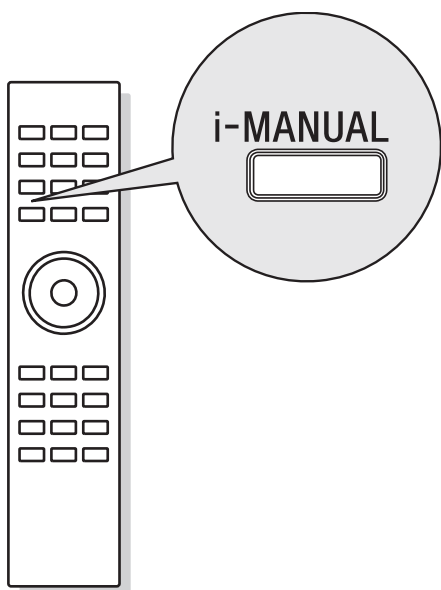

BRAVIA

Sony Customer Support

U.S.A.: www.sony.com/tvsupport

Canada: www.sony.ca/support

United States

Canada

1.800.222.SONY

1.877.899.SONY

Please Do Not Return
the Product to the Store

Owner's Record

The information label are located on the rear of the TV. Record model name and serial numbers on the information label in the spaces provided below. Refer to them whenever you call upon your Sony dealer regarding this TV.

Model Name

Serial No.

CAUTION

To prevent electric shock and blade exposure, do not use this polarized AC plug with an extension cord, receptacle or other outlet unless the blades can be fully inserted.

- Operate the TV only on 110-240 V AC (U.S.A./Canada 120 V AC)
- Avoid operating the TV at temperatures below 41°F (5°C).
- Some people may experience discomfort (such as eye strain, fatigue, or nausea) while watching 3D video images or playing 3D video games. Sony recommends that all viewers take regular breaks while watching 3D video images or playing 3D video games. The length and frequency of necessary breaks will vary from person to person. You must decide what works best. If you experience any discomfort, you should stop watching the 3D video images or playing 3D video games until the discomfort ends; consult a doctor if you believe necessary. You should also review (i) the instruction manual of any other device or media used with this television and (ii) our website (www.sony.com/tvsupport) for the latest information. The vision of young children (especially those under six years old) is still under development. Consult your doctor (such as a pediatrician or eye doctor) before allowing young children to watch 3D video images or play 3D video games. Adults should supervise young children to ensure they follow the recommendations listed above.
- When using the simulated 3D function, please note that the displayed image is modified from the original due to the conversion done by this television.

Licensing Information

Macintosh is a trademark of Apple Inc., registered in the U.S. and other countries.

HDMI, the HDMI Logo, and High-Definition Multimedia Interface are trademarks or registered trademarks of HDMI Licensing LLC in the United States and other countries.

Ferguson Patent Properties, LLC:

U.S. Patent No. 5,717,422

U.S. Patent No. 6,816,141

Manufactured under license from Dolby Laboratories. Dolby and the double-D symbol are trademarks of Dolby Laboratories.

In the United States, TV Guide and TV Guide On Screen are registered trademarks of TV Guide Entertainment Group, Inc. and/or its subsidiaries or affiliates, and are used under a license by Gemstar-TV Guide International, Inc. and/or its subsidiaries. In Canada, TV Guide is a registered mark of Transcontinental Inc., and is used under a license by Gemstar-TV Guide International, Inc. and/or its subsidiaries.

The TV Guide On Screen system is manufactured under license from Gemstar-TV Guide International, Inc. and/or its subsidiaries.

The TV Guide On Screen system is protected by one or more of the following United States patents 6,498,895; 6,850,693; 6,396,546; 5,940,073; 6,239,794 to Gemstar-TV Guide International, Inc. and/or its subsidiaries.

Gemstar-TV Guide International, Inc. and/or its related affiliates are not in any way liable for the accuracy or availability of the program schedule information or other data in the TV Guide On Screen system and cannot guarantee service availability in your area. In no event shall Gemstar-TV Guide International, Inc. and/or its related affiliates be liable for any damages in connection with the accuracy or availability of the program schedule information or other data in the TV Guide On Screen system.

Blu-ray Disc is a trademark.

“BRAVIA” and BRAVIA, S-Force, Motionflow, BRAVIA Sync, and  are trademarks or registered marks of Sony Corporation.

“XMB™” and “Xross media bar” are trademarks of Sony Corporation and Sony Computer Entertainment Inc.

“PlayStation” is a registered trademark and “PS3” is a trademark of Sony Computer Entertainment Inc.

DLNA®, the DLNA Logo and DLNA CERTIFIED® are trademarks, service marks, or certification marks of the Digital Living Network Alliance.



Your BRAVIA TV is ENERGY STAR® qualified in the “Home” mode.

It meets strict energy efficiency guidelines set by the U.S. Environmental Protection Agency and Department of Energy. ENERGY STAR is a joint program of these government agencies, designed to promote energy efficient products and practices.

Changes to certain features, settings, and functionalities of this TV (i.e. TV Guide, Picture/Sound, Light Sensor, Power Savings) can increase or change the power consumption.

Depending upon such changed settings, the power consumption may exceed the limits required for the ENERGY STAR qualification in the “Home” mode.

The 55 class has a 54.6 inch viewable image size (measured diagonally).



- The illustrations of the remote control used in this manual are of the RM-YD040 unless otherwise stated.
- The illustrations used in this manual may differ depending on your TV model.



Table of Contents

Checking the accessories.....	4
Inserting batteries into the remote control	4
Setting up your TV	
Attaching the Table-Top Stand.....	6
Connecting the TV.....	8
Securing the TV.....	12
Organizing the AC power cord	13
Running initial setup	14
Detaching the Table-Top Stand from the TV.....	14
Using a Wall-Mount Bracket.....	15
Installing the TV Against a Wall or Enclosed Area	15
To watch TV	
To watch programs.....	16
To use the TV features.....	16
To use i-Manual.....	17
Additional Information	
Troubleshooting.....	18
Specifications	20

- Operating instructions are built into your **BRAVIA** TV. Refer to “To use i-Manual” for operation (page 17).
- Retain this manual for future reference.

The BRAVIA® Full HDTV Experience

Thank you for choosing Sony! Your new BRAVIA® TV opens the door to the “Full HDTV Experience.” This document will help you get the most out of your TV.

Please take a moment to register your TV at:

U.S.A.: <http://productregistration.sony.com>

Canada: <http://www.SonyStyle.ca/registration>

Four Steps to a Full HD Experience

Set, Source, Sound, and Setup.

1 Set

Now that you have made the best selection in LCD TV technology, be sure to remove all accessory contents from the packaging before setting up your TV.

2 Source

To experience the stunning detail of your **BRAVIA** TV, you need access to HD programming.

- Upgrade your signal or content source to high-definition (HD) by contacting your HD service provider.

- Receive over-the-air HD broadcasts with an HD-quality antenna connected directly to the back of your TV.

Visit www.antennaweb.org for more information on antenna selection and setup.

- Discover the wealth of entertainment now available on super-high resolution Blu-ray Disc™ player and other Sony HD equipment.

3 Sound

Complete the high-definition experience with a **BRAVIA** Sync™ surround sound system or A/V receiver from Sony.

4 Setup

Install your TV and connect your sources. See page 8 for sample connection diagrams.

To help assure the highest quality for your HD experience, use Sony HDMI (High-Definition Multimedia Interface) cables.

To learn more about HDTV, visit:

U.S.A.: <http://www.sony.com/HDTV>

Canada: <http://www.SonyStyle.ca/hd>

This TV displays all video input signals in a resolution of 1,920 dots × 1,080 lines.

Checking the accessories

AC power cord (1)

Remote control (1)*¹

Size AAA batteries (2)

Table-Top Stand (1)*²

Fixing screws for Table-Top Stand

(M5 × 16) (4)

Assembling screws for Table-Top Stand

(M5 × 16) (4) (KDL-40HX800 only)

Stand rear cover (1)*³

*1 Please refer to the model name printed on the remote control.

*2 KDL-40HX800 requires assembling. Refer to other leaflet to assemble the Table-Top Stand.

*3 For KDL-55/46HX800, the stand rear cover is factory-attached to the Table-Top Stand.

Inserting batteries into the remote control

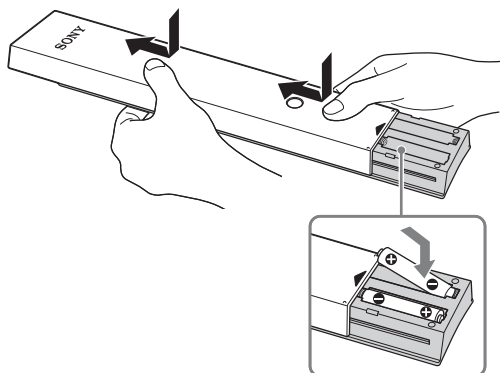

- 1 Remove the protection sheet.
- 2 Push and slide the cover upward.

Guidelines for Remote Control

- Point your remote control directly at the IR sensor located on your TV.
- Make sure that no objects are blocking the path between the remote control and the IR sensor on your TV.
- Fluorescent lamps can interfere with your remote control; try turning off the fluorescent lamps.
- If you are having problems with the remote control, reinsert or replace your batteries and make sure that they are correctly inserted.

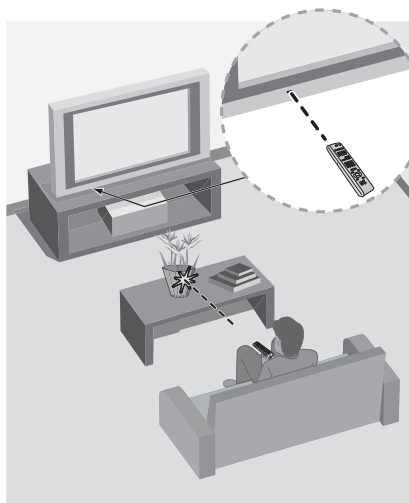

Programming the Remote Control

(For RM-ED038 and RM-ED053 remote control users)

Your remote control can be programmed to use other equipment and is pre-programmed to operate the following Sony equipment.

Function Button	Sony Equipment	Code Number
DVD	DVD Player	31033
AMP	Receiver	52172
STB	Digital Satellite	01639

Programming Other Equipment

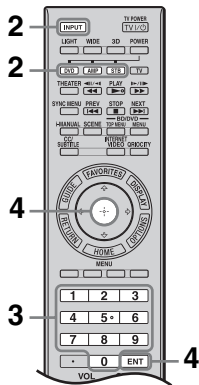

Follow the steps below to program your TV remote control.

- 1 Look for the code in the Manufacturer's Code List (refer to i-Manual) that corresponds to the equipment you would like to operate with the Sony remote control. If more than one code is provided, try programming the first code listed. If your equipment's code is not listed, visit <http://esupport.sony.com/remotecodes> for a more comprehensive list.
- 2 Press and hold a **DVD**, **AMP** or **STB** function button simultaneously with **INPUT** button and release.
When in the programming mode, the function button (**DVD**, **AMP**, **STB**) blinks for approximately 30 seconds until a code is entered.
- 3 Enter the five digit code using **0** - **9** while the function buttons (**DVD**, **AMP**, **STB**) are lit. If the code is not entered within 30 seconds, you must repeat step 2.
- 4 Press **+** or **ENT** to confirm the code. If successfully programmed, the function button (**DVD**, **AMP**, **STB**) will blink twice, if not, it blinks five times.



- Button names may differ slightly depending on the remote control.

Confirm the Programming

If you can turn your equipment on and off using the green **POWER** button, the programming is complete. If not, try the next code listed.



- In some cases, you may not be able to program your remote control. If this is the case, use your equipment's own remote control.
- Any of the function buttons (**DVD**, **AMP**, **STB**) can be programmed to operate other equipment regardless of the labeling. For example, if programmed with the correct code, a Blu-ray Disc player can be operated with the **DVD** button. This is useful if your equipment does not match any of the labeled buttons.

To reset the remote control to the factory default:

Press **SCENE**, **TV POWER**, and **+** simultaneously. The four function buttons (**DVD**, **AMP**, **STB**, and **TV**) blink when successfully reset.

Setting up your TV

Some TV models are packaged with a detached Table-Top Stand so you can mount your TV to a wall right away. If you are not mounting the TV to a wall, you will need to attach the Table-Top Stand. You will need a Phillips screwdriver and the supplied screws to complete the task. Look for the supplied Table-Top Stand instruction leaflet.

Be sure to consider the following while setting up your TV:

- Disconnect all cables when carrying the TV.
- Carry the TV with the adequate number of people; larger size TVs require two or more people.
- Correct hand placement while carrying the TV is very important for safety and to avoid damage.

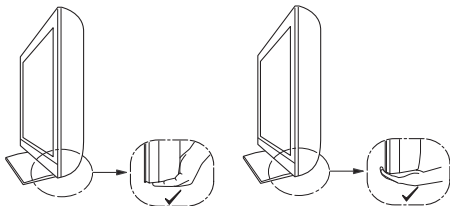
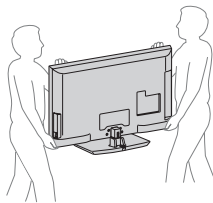

For XBR-52/46HX909 For KDL-55/46/40HX800

- Ensure your TV has adequate ventilation, see page 15.
- For best picture quality, do not expose the screen to direct illumination or sunlight.
- Avoid installing the TV in a room with reflective wall and floor materials.
- Avoid moving the TV from a cold area to a warm area. Sudden room temperature changes may cause moisture condensation. This may cause the TV to show poor picture and/or poor color. Should this occur, allow moisture to evaporate completely before powering the TV on.

Attaching the Table-Top Stand

Refer to the supplied Table-Top Stand instruction leaflet for proper attachment for some TV models.

- 1** Gently slide the TV unit onto the Table-Top Stand and align the screw holes.



- Do not put stress on the LCD panel or the frame around the screen.
- Be careful to not pinch your hands or the AC power cord when you install the TV unit to the Table-Top Stand.

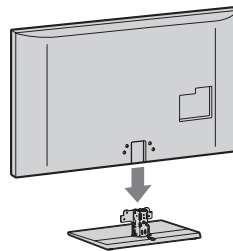

- 2** Use the supplied screws to attach the TV unit to the Table-Top Stand.

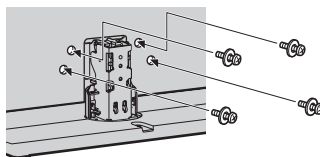

- If you use an electric screwdriver, set the tightening torque at approximately 1.5 N·m {15 kgf·cm}.

- 3** For XBR-52/46HX909 and KDL-40HX800, after all the screws are tighten cover the Table-Top Stand with the supplied stand rear cover.



- You can attach the TV to the Table-Top Stand with the stand rear cover on with the exception of XBR-52/46HX909 and KDL-40HX800. XBR-52/46HX909 and KDL-40HX800 must follow the above instructions.

Adjusting the viewing angle (XBR-52/46HX909 only)



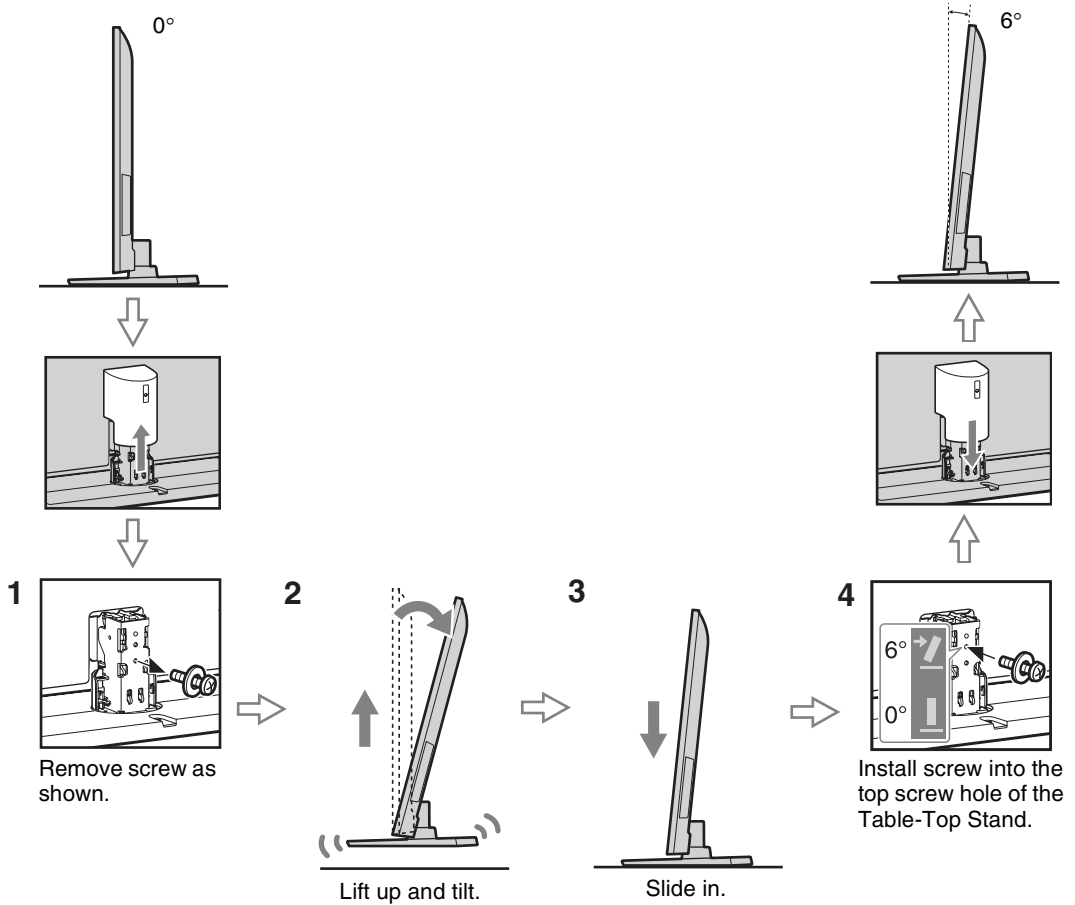

This TV can be adjusted within the angles shown below.

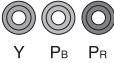

- Reverse the steps when readjusting the angle back to 0 degrees.

Connecting the TV

The following chart shows the high-definition (HD) and standard-definition (SD) video formats supported by your **BRAVIA** TV inputs.

	INPUT	VIDEO	AUDIO	SUPPORTED FORMATS								
				1080/24p	1080p	1080i	720/24p	720p	480p	480i	PC*	
HD	HDMI		When HDMI is connected to DVI with an adapter, a separate Audio L/R is necessary.	✓	✓	✓	✓	✓	✓	✓	✓	✓
	COMPONENT	 Y Pb Pr	 Audio L/R		✓	✓		✓	✓	✓		
SD	VIDEO	 Composite video connection	 Audio L/R								✓	

* For supported PC formats refer to the i-Manual.

Recommendation of the F type plug

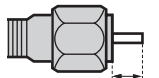

1.5 mm

Projection of the inner wire from the connection part must be less than 1.5 mm.

Shown with a Set Top Box with HDMI connection

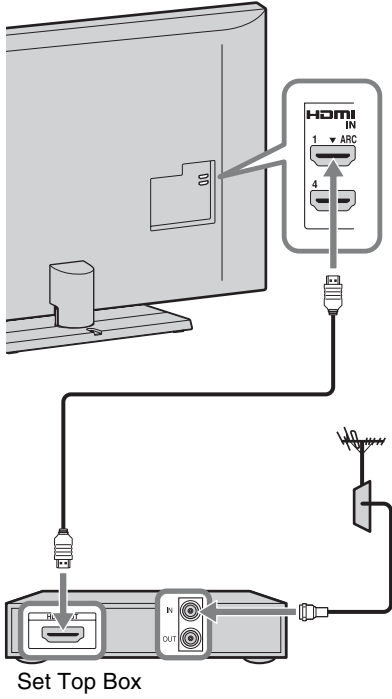

Shown with a Set Top Box with COMPONENT connection

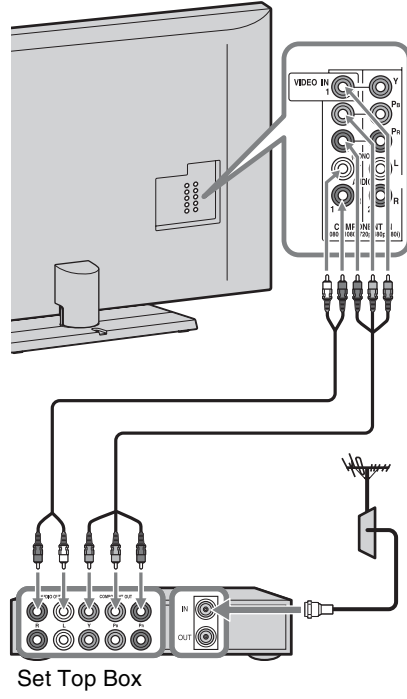

Cable System or VHF/UHF Antenna System

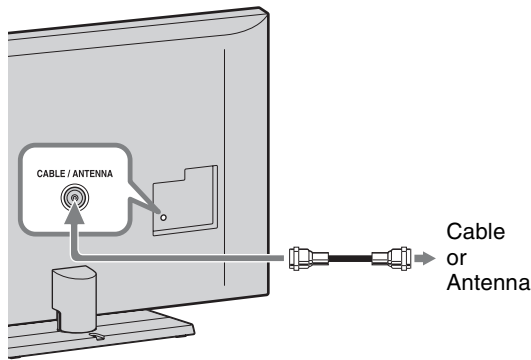

Shown with HD BRAVIA® Sync™ Basic Connection

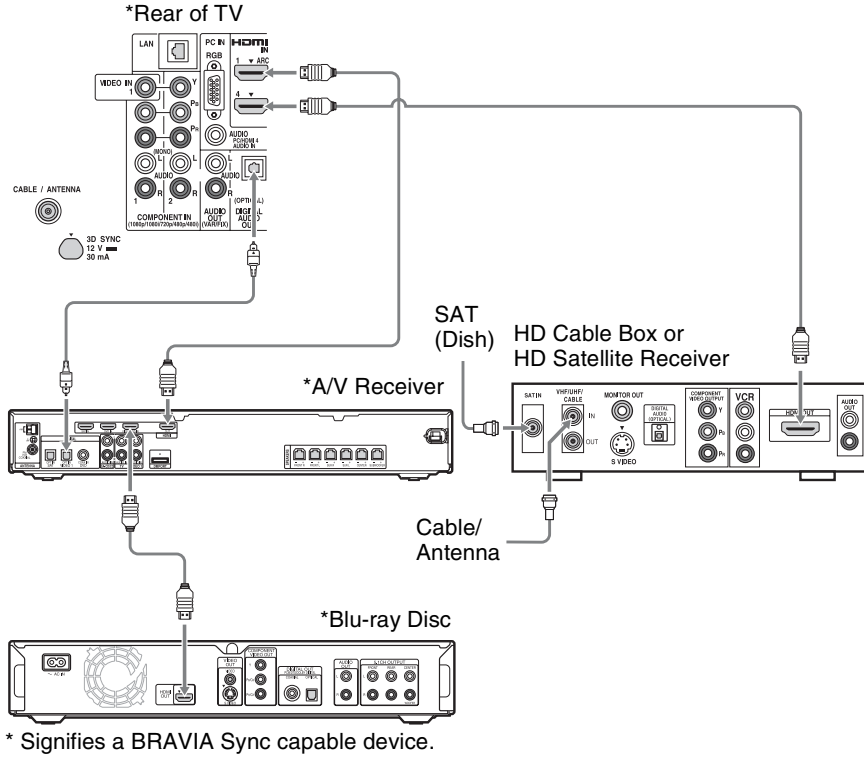

Shown with HD Basic Connection with Home Theater System

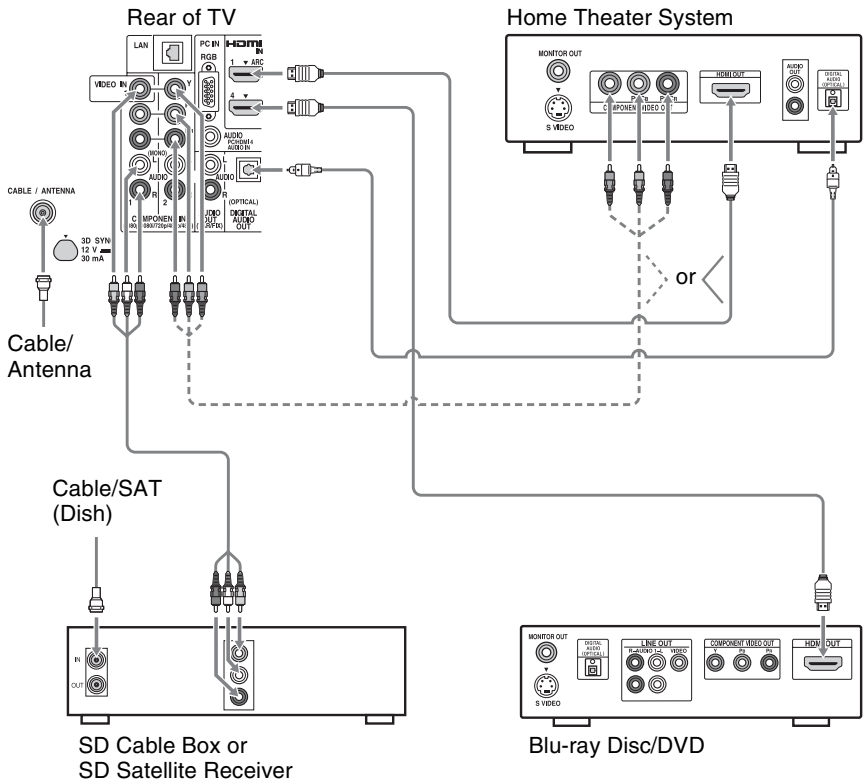

Shown with PC Connection with SD VCR/DVD

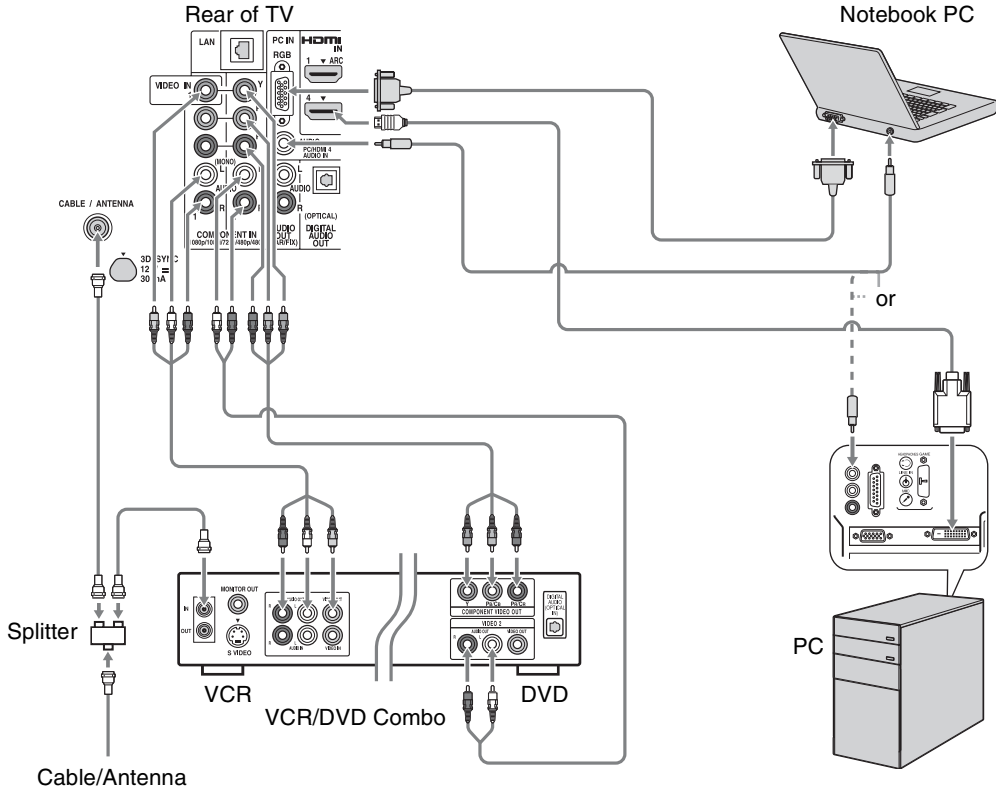

Securing the TV



Sony strongly recommends taking measures to prevent the TV from toppling over.

Unsecured TVs may topple and result in property damage, serious bodily injury or even death.

Preventing the TV from Toppling

- Secure the TV to a wall and/or stand.
- Do not allow children to play or climb on furniture and TV sets.
- Avoid placing or hanging items on the TV.
- Never install the TV on:
 - slippery, unstable and/or uneven surfaces.
 - furniture that can easily be used as steps, such as a chest of drawers.
- Install the TV where it cannot be pulled, pushed, or knocked over.
- Route all AC power cords and connecting cables so that they are not accessible to curious children.

Recommended Measures to Secure the TV

Consider the following measures when securing your TV to a Stand (not supplied).

1 Secure the Stand for the TV

Make sure the Stand can adequately support the weight of the TV. Use two angle braces (not supplied) to secure the stand. For each angle brace use the appropriate hardware to:

- Attach one side of the angle brace to the wall stud.
- Attach the other side to the Stand.

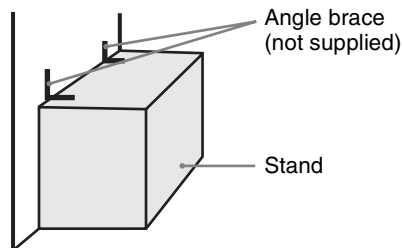

2 Secure the TV to the Stand

Use the optional hardware listed below (not supplied):

- M4 × 16 machine screw (screwed into the TV's Table-Top Stand)
- A screw or similar (attach it to the Stand)
- Rope or chain (strong enough to support the weight of the TV). Make sure that there is no excess slack in the rope or chain.

An alternative way to secure the TV is with an optional Sony Support Belt Kit.

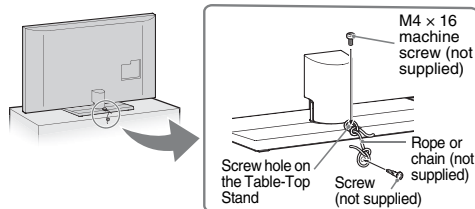

Contact Sony Customer Support to obtain the optional Support Belt Kit by providing your TV model name.

- For United States call: 1-800-488-7669 or visit: www.sony.com/accessories
- For Canada call: 1-877-899-7669

3 Anchor the TV to the Wall

Anchor the TV to the wall by using bolts, wall anchor and chain (or rope).

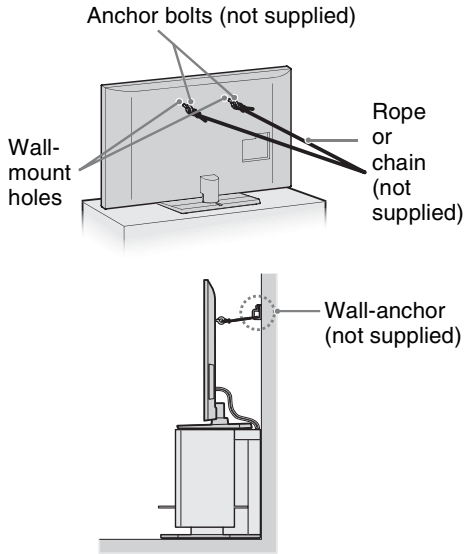

- KDL-55HX800 is shipped with screws attached to the rear of the TV. (They are fastened in the screw holes for wall mounting.) Be sure to remove the upper two screws prior to installing the TV on a wall.
- Securing the TV to the stand without securing the TV and the stand to the wall provides minimum protection against the TV toppling over. For further protection, be sure to follow the three measures recommended.

Organizing the AC power cord

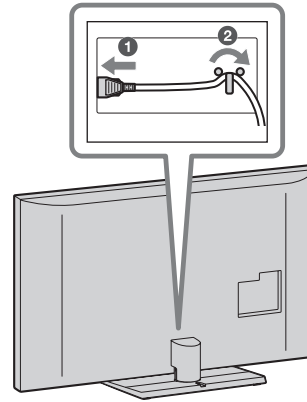

Running initial setup

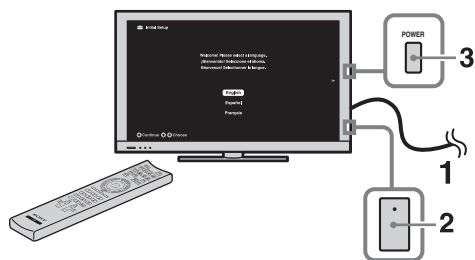

- 1 Complete your cable connections before proceeding with the **Initial Setup**.
Connect the TV to your nearest power outlet.
- 2 Check the **ENERGY SAVING SWITCH** setting is on (●).
- 3 Press **POWER** on the TV.
When you switch the TV on for the first time, the **Language** menu appears on the screen.

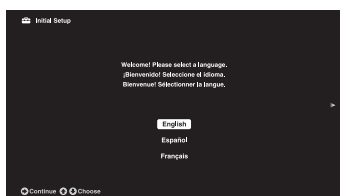

- 4 Follow the instructions on the screen.

- The **ENERGY SAVING SWITCH** must be on (●) to set the clock and obtain program information for the TV Guide.
 - **Home** mode sets the TV to settings optimized for home viewing (this setting is ENERGY STAR compliant).
- 5 Select **Continue** to scan for available channels and enable the **TV Guide On Screen**® feature. If you receive channels from a cable box or satellite receiver and do not wish to use the TV's built-in tuner, select **Skip**.
Selecting **Skip** will disable the **TV Guide On Screen** feature, which is only available when the TV's tuner is used.

- If you skip the channel scan while in the setup menus, TV Guide will be disabled.

Detaching the Table-Top Stand from the TV

Remove only the screws marked with ↑ on the TV.

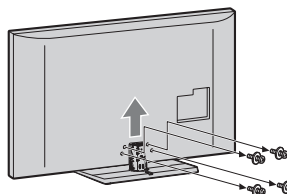

- Do not remove the Table-Top Stand for any reason other than to install corresponding accessories on the TV.
- For XBR-52/46HX909 and KDL-40HX800, remove the stand rear cover prior to detaching the Table-Top Stand.
- For KDL-55HX800, when installing the TV on a wall, remove the four screws from the rear of the TV. (They are fastened in the screw holes for wall mounting.) Be sure to store the removed screws in a safe place, keeping them away from children.
- For KDL-55HX800, when attaching the Table-Top Stand again, be sure to fasten the four screws (previously removed) to the original holes on the rear of the TV.
- Do not hold by the stand rear cover while carrying the Table-Top Stand to prevent dropping the stand which may cause an injury or damage to the property.

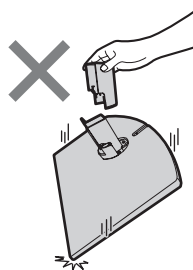

Using a Wall-Mount Bracket

Your TV can be mounted on a wall using a Wall-Mount Bracket (not supplied) out of the box as packaged. If the Table-Top Stand is attached to the TV, the TV may require detaching the Table-Top Stand; see “Detaching the Table-Top Stand from the TV” (page 14). Prepare the TV for the Wall-Mount Bracket before making cable connections.

For product protection and safety reasons, Sony strongly recommends that you use the Wall-Mount Bracket designed for your TV and the installation should be performed by a Sony dealer or licensed contractor.

- Follow the instruction guide provided with the Wall-Mount Bracket for your model. Sufficient expertise is required in installing this TV, especially to determine the strength of the wall for withstanding the TV's weight.

- Be sure to use the screws supplied with the Wall-mount bracket when attaching the mounting hooks to the TV set.

The supplied screws are designed so that they are 8 mm to 12 mm in length when measured from the attaching surface of the mounting hook.

The diameter and length of the screws differ depending on the Wall-mount bracket model. Use of screws other than those supplied may result in internal damage to the TV set or cause it to fall, etc.

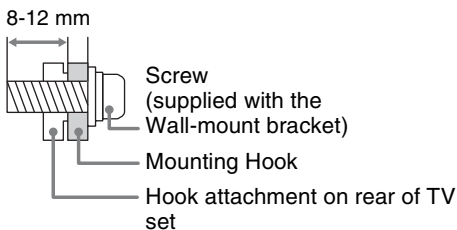

- Be sure to store the unused screws and Table-Top Stand in a safe place until you are ready to attach the Table-Top Stand. Keep the screws away from small children.



- Read the supplied Safety Booklet for additional safety information.

Installing the TV Against a Wall or Enclosed Area

Make sure that your TV has adequate ventilation. Allow enough space around the TV as shown below. Avoid operating the TV at temperatures below 41 °F (5 °C).

Installed with stand

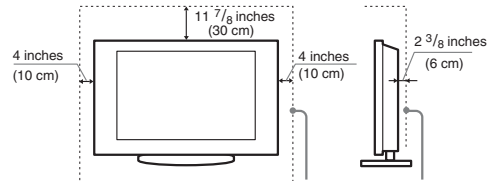

Leave at least this much space around the set.

Installed on the wall

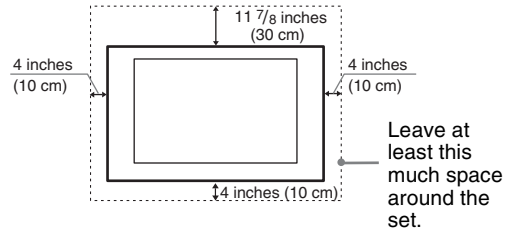

Leave at least this much space around the set.

Never install the TV set as follows:

Air circulation is blocked. Air circulation is blocked.

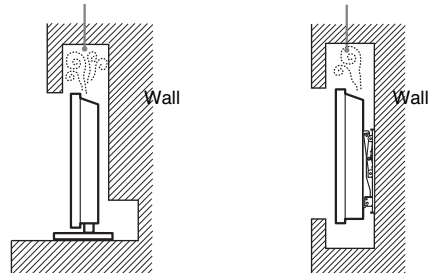

- Inadequate ventilation can lead to overheating of the TV and may cause damage to your TV or cause a fire.

To watch TV

To watch programs

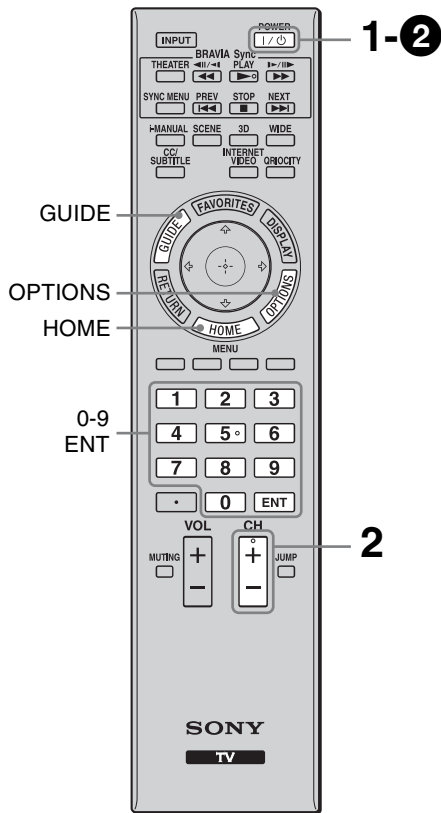

1 Turn on the TV.

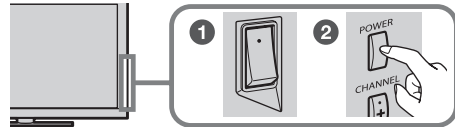



1 Check the **ENERGY SAVING SWITCH** setting is on (●).

2 Press **POWER** on the TV or on the remote control to turn on the TV. (You may use the  button located on the front or back of the remote control.)

2 Select a TV channel.



To use the Guide

Press **GUIDE** to display the **TV Guide On Screen** to view scheduled programs or to select a program to watch. Press again to exit the Guide. Use with **0-9** and **ENT** to select digital channels. For example, to enter 2.1, press , ,  and **ENT**.



To use the TV features

Press **HOME** to display **TV Home Menu/XMB™** to access **TV Settings** and other media and network related content.

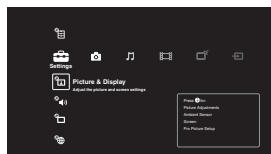

Press **OPTIONS** to display a list of convenient functions and menu shortcuts. The Options menu items vary based on current input and/or content.

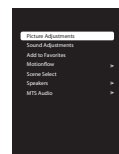

To use i-Manual

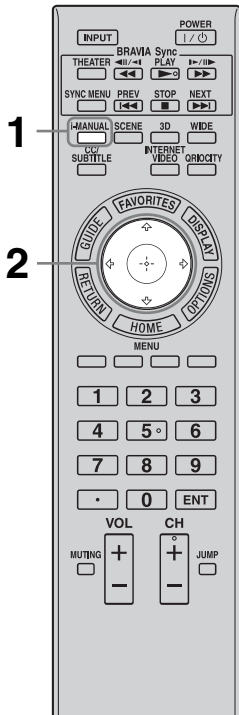

Your **BRAVIA** TV comes with an on-screen manual. To learn more about your TV's features you can access your i-Manual with the touch of a button.

1 Press i-MANUAL.



2 Press $\uparrow/\downarrow/\leftarrow/\rightarrow/\oplus$ to navigate and select items.

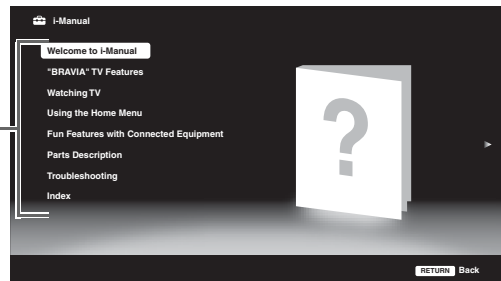
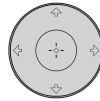

- **Welcome to i-Manual**
- **“BRAVIA” TV Features**
- **Watching TV**

Introduces convenient features such as TV Guide, Favorites, etc.

■ **Using the Home Menu**

You can find how to customize your TV settings, etc.

- **Fun Features with Connected Equipment**

Introduces how to connect and enjoy optional equipment.

■ **Parts Description**

■ **Troubleshooting**

You can find solutions for your problems.

- **Index**



- Images and illustrations may differ from what you are watching on this TV.

Troubleshooting

The TV will indicate any problems with the **STANDBY** indicator flashing in red.

When the **STANDBY** indicator is flashing

The self-diagnosis function is activated.

- 1 Count how many times the **STANDBY** indicator flashes between each three second break.
For example, the indicator may flash three times, go off for three seconds, then flash again three times.
- 2 Press **POWER** on the TV to turn it off, disconnect the AC power cord, and contact Sony Customer Support (information provided on the front cover) with how many times the indicator flashes.

When the **STANDBY** indicator is not flashing

- 1 Check the items in the tables below. (Also refer to “Troubleshooting” in the i-Manual.)
- 2 If the problem persists, contact Sony Customer Support (information provided on the front cover).

Condition	Explanation/Solution
Picture	
There is no picture (screen is dark) and no sound.	<ul style="list-style-type: none">• Check the antenna/cable connection.• Connect the TV to the AC power, and press POWER on the TV.• If the STANDBY indicator lights up in red, press POWER on the remote control.
Tiny black dots and/or bright dots appear on the screen.	<ul style="list-style-type: none">• The screen is composed of pixels. Tiny black dots and/or bright dots (pixels) on the screen do not indicate a malfunction.
General	
The TV’s power cannot be turned on.	<ul style="list-style-type: none">• Check to see the (●) mark on the ENERGY SAVING SWITCH is pressed.
The TV turns off automatically (the TV enters standby mode).	<ul style="list-style-type: none">• Check if the Sleep Timer, Timer, or Idle TV Standby is activated.• The Auto Shut-off function may be set to On. If Auto Shut-off is activated and TV receives no signal, the TV will automatically enter standby mode in 15 minutes. Check Auto Shut-off is activated under Eco feature of this TV.
The remote does not function.	<ul style="list-style-type: none">• Replace the batteries.• Your TV may be in SYNC mode. Press SYNC MENU, select TV Control and then select Home (Menu) or Options to control the TV.
The TV and its surrounding become warm.	<ul style="list-style-type: none">• When the TV is used for an extended period of time, the TV and its surround may become warm to touch. This is not malfunction of the TV.
The Parental Lock password has been forgotten.	<ul style="list-style-type: none">• Enter 4357 for the PIN code. (PIN code 4357 is always accepted.)

How to Care for Your BRAVIA

Safety is very important, please read and follow the safety documentation (Safety Booklet) separately provided.

Unplug the TV and other connected equipment from the wall outlet before you begin cleaning your TV.

- Wipe the LCD screen gently with a soft cloth.
- Stubborn stains may be removed with a cloth slightly moistened with a solution of mild soap and warm water.
- If using a chemically pretreated cloth, please follow the instruction provided on the package.
- Never use strong solvents such as a thinner, alcohol or benzine for cleaning.
- Do not plug in the TV into the wall outlet until the moisture from cleaning has evaporated.

The TV should also be placed on a stable surface to prevent it from toppling over (see page 12). If you have young children or pets at home, check regularly to insure the TV is securely fastened.



Specifications

System	
Television system	NTSC: American TV standard ATSC (8VSB terrestrial): ATSC compliant 8VSB QAM on cable: ANSI/SCTE 07 2000 (Does not include CableCARD functionality)
Channel coverage	Analog terrestrial: 2 - 69 / Digital terrestrial: 2 - 69 Analog Cable: 1 - 135 / Digital Cable: 1 - 135
Panel system	LCD (Liquid Crystal Display) Panel
Speaker output	10 W + 10 W
Input/Output jacks	
CABLE/ANTENNA	75-ohm external terminal for RF inputs
VIDEO IN 1/2	VIDEO / AUDIO
COMPONENT IN 1/2	YPBPR (Component Video) / Signal format: 480i, 480p, 720p, 1080i, 1080p / AUDIO
HDMI IN 1/2/3/4	HDMI: Video: 480i, 480p, 720p, 720/24p, 1080i, 1080p, 1080/24p Audio: Two channel linear PCM 32, 44.1 and 48 kHz, 16, 20 and 24 bits, Dolby Digital AUDIO (HDMI IN 4)
AUDIO OUT	500 mVrms (typical)
DIGITAL AUDIO OUT (OPTICAL)	PCM/Dolby Digital optical signal
PC IN	D-sub 15-pin, analog RGB
PC/HDMI 4 AUDIO INPUT	Stereo mini jack
LAN	10BASE-T/100BASE-TX connector (Connection speed may differ depending on the network environment, 10BASE-T/100BASE-TX communication rate and communication quality are not guaranteed for this TV.)* ¹
USB/DLNA	Refer to the i-Manual for supported format.
3D SYNC	3D Sync terminal for optional transmitter
REMOTE (HX909 series only)	RS232C, D-sub 9 pin. This jack is for receiving the external control signal.

Model name KDL-/XBR-	55HX800	52HX909	46HX909	46HX800	40HX800
Power and others					
Power requirement	110 V - 240 V AC, 50/60 Hz (U.S.A./Canada 120 V AC, 60 Hz)				
Power consumption in use	167 W	201 W	184 W	149 W	132 W
in DAM* ²	14 W (You may hear a clicking noise during the download but this is normal.)				
in standby	Less than 0.12 W with 120 V AC and less than 0.2 W with 240 V AC				
Screen size (inches measured diagonally)	54.6 inches (55 class)	52 inches	46 inches		40 inches
Display resolution	1,920 dots (horizontal) × 1,080 lines (vertical)				
Speaker Full range with speaker box (2)	34 × 160 mm (1 3/8 × 6 3/8 inches)	34 × 100 mm (1 3/8 × 4 inches)		34 × 160 mm (1 3/8 × 6 3/8 inches)	
Dimensions withstand	1,278 × 797 × 350 mm (50 3/8 × 31 1/2 × 13 7/8 inches)	1,263 × 807 × 400 mm (49 3/4 × 31 7/8 × 15 3/4 inches)	1,124 × 727 × 400 mm (44 3/8 × 28 5/8 × 15 3/4 inches)	1,085 × 688 × 260 mm (42 3/4 × 27 1/8 × 10 1/4 inches)	952 × 613 × 250 mm (37 1/2 × 24 1/4 × 9 7/8 inches)
without stand	1,278 × 765 × 73 mm (50 3/8 × 30 1/8 × 2 7/8 inches)	1,263 × 775 × 67 mm (49 3/4 × 30 5/8 × 2 3/4 inches)	1,124 × 695 × 67 mm (44 3/8 × 27 3/8 × 2 3/4 inches)	1,085 × 656 × 74 mm (42 3/4 × 25 7/8 × 3 inches)	952 × 581 × 74 mm (37 1/2 × 22 7/8 × 3 inches)
wall-mount hole pattern	400 × 300 mm (15 7/8 × 11 7/8 inches)				
wall-mount screw size	M6 (length: refer to diagram on page 15.)				
Mass with stand	26.9/59.3 (kg)/(lb.)	42.9/94.5	36.2/79.8	19.2/42.3	16.4/36.2
without stand	22.6/49.8	36.9/81.3	30.2/66.6	16.9/37.3	14.2/31.3
Supplied accessories	See "Checking the accessories" (page 4).				
Optional accessories	Connecting cables / Support Belt Kit / Wall-Mount Bracket / TV Stand / 3D Glasses (TDG-BR100/TDG-BR50) / 3D Sync Transmitter (TMR-BR100)				

*1 For LAN connections, use a Category 7 10BASE-T/100BASE-TX cable (not supplied).

*2 Download Acquisition Mode (DAM) is used for software updates and/or collecting data for TV Guide On Screen.

- Optional accessories availability depends on its stock.
- Design and specifications are subject to change without notice.

Declaration of Conformity

Trade Name: SONY
Model: KDL-55HX800/XBR-52HX909/XBR-46HX909/
KDL-46HX800/KDL-40HX800
Responsible Party: Sony Electronics Inc.
Address: 16530 Via Esprillo,
San Diego, CA 92127 U.S.A.
Telephone Number: 858-942-2230

This device complies with part 15 of the FCC rules.
Operation is subject to the following two conditions:
(1) This device may not cause harmful interference, and
(2) this device must accept any interference received,
including interference that may cause undesired
operation.

For customers in Canada

This Class B digital apparatus complies with Canadian
ICES-003.

FCC Related Information

This equipment has been tested and found to comply with the limits for a Class B digital device, pursuant to Part 15 of the FCC Rules. These limits are designed to provide reasonable protection against harmful interference in a residential installation. This equipment generates, uses and can radiate radio frequency energy and, if not installed and used in accordance with the instructions, may cause harmful interference to radio communications. However, there is no guarantee that interference will not occur in a particular installation. If this equipment does cause harmful interference to radio or television reception, which can be determined by turning the equipment off and on, the user is encouraged to try to correct the interference by one or more of the following measures:

- Reorient or relocate the receiving antenna.
- Increase the separation between the equipment and receiver.
- Connect the equipment into an outlet on a circuit different from that to which the receiver is connected.
- Consult the dealer or an experienced radio/TV technician for help.

Pursuant to FCC regulations, you are cautioned that any changes or modifications not expressly approved in this manual could void your authority to operate this equipment.

Note

This television includes a QAM demodulator which should allow you to receive unscrambled digital cable television programming via subscription service to a cable service provider. Availability of digital cable television programming in your area depends on the type of programming and signal provided by your cable service provider.

Compatible Optional Accessories Information

Use the following Sony optional accessories with your TV model.

	Sony TV Model No.			
KDL-/XBR-	55HX800	52HX909	46HX909	46HX800/ 40HX800
Sony Wall-Mount Bracket Model No.	SU-WL500			
Sony TV Stand No.*	-	SU-52HX1	SU-46HX1	-

* Some of these TV Stand models may not be available in your area.

Use with other optional accessories may cause instability and could result in property damages or injury.

For instructions on using the Wall-Mount bracket with your TV please go to <http://esupport.sony.com> for your TV model and download "Additional Information for Using Sony Wall-Mount Bracket".

To Customers

Sufficient expertise is required for TV installations. Be sure to subcontract the installation to a Sony dealer or licensed contractor and pay adequate attention to safety during the installation.

For Your Convenience

Online Registration:	Be sure to register your TV. United States http://productregistration.sony.com Canada http://www.SonyStyle.ca/registration
Software Updates:	Your TV is capable of receiving software updates. For the latest information about software updates for your TV, visit: United States http://www.sony.com/tvsupport Canada http://www.sony.ca/support NOTE: If your TV is connected to the Internet, you can check for software updates by selecting Settings, Product Support and then Automatic Software Update .

