



LCD Digital Color TV



Operating Instructions

KDL-40XBR4 KDL-40XBR5
KDL-46XBR4 KDL-46XBR5
KDL-52XBR4 KDL-52XBR5

BRAVIA

XBR

Owner's Record

The model and serial numbers are located at the rear of the TV. Record these numbers in the spaces provided below. Refer to them whenever you call upon your Sony dealer regarding this TV.

Model Name

Serial No.

WARNING

To reduce the risk of fire or electric shock, do not expose this TV to rain or moisture.



This symbol is intended to alert the user to the presence of uninsulated "dangerous voltage" within the TV's enclosure that may be of sufficient magnitude to constitute a risk of electric shock to persons.



This symbol is intended to alert the user to the presence of important operating and maintenance (servicing) instructions in the literature accompanying the TV.

The TV shall not be exposed to dripping or splashing and no objects filled with liquids, such as vases, shall be placed on the TV.

CAUTION

To prevent electric shock, do not use this polarized AC plug with an extension cord, receptacle or other outlet unless the blades can be fully inserted to prevent blade exposure.

Declaration of Conformity

Trade Name: SONY
 Model: KDL-40XBR4/KDL-46XBR4/
 KDL-52XBR4/KDL-40XBR5/
 KDL-46XBR5/KDL-52XBR5
 Responsible Party: Sony Electronics Inc.
 Address: 16530 Via Esprillo,
 San Diego, CA 92127 U.S.A.
 Telephone Number: 858-942-2230

This device complies with part 15 of the FCC rules. Operation is subject to the following two conditions: (1) This device may not cause harmful interference, and (2) this device must accept any interference received, including interference that may cause undesired operation.

NOTIFICATION

This equipment has been tested and found to comply with the limits for a Class B digital device, pursuant to Part 15 of the FCC Rules. These limits are designed to provide reasonable protection against harmful interference in a residential installation. This equipment generates, uses and can radiate radio frequency energy and, if not installed and used in accordance with the instructions, may cause harmful interference to radio communications.

However, there is no guarantee that interference will not occur in a particular installation. If this equipment does cause harmful interference to radio or television reception, which can be determined by turning the equipment off and on, the user is encouraged to try to correct the interference by one or more of the following measures:

- Reorient or relocate the receiving antenna.
- Increase the separation between the equipment and receiver.
- Connect the equipment into an outlet on a circuit different from that to which the receiver is connected.
- Consult the dealer or an experienced radio/TV technician for help.

Pursuant to FCC regulations, you are cautioned that any changes or modifications not expressly approved in this manual could void your authority to operate this equipment.

Safety

- Operate the TV only on 120 - 240 V AC.
- Use the AC power cord specified by Sony and suitable for the voltage where you use it.
- The plug is designed, for safety purposes, to fit into the wall outlet only one way. If you are unable to insert the plug fully into the outlet, contact your dealer.
- If any liquid or solid object should fall inside the cabinet, unplug the TV immediately and have it checked by qualified service personnel before operating it further.
- If you will not be using the TV for several days, disconnect the power by pulling the plug itself. Never pull on the cord.
- For details concerning safety precautions, see "Important Safety Instructions" on page 4.

Installing

- The TV should be installed near an easily accessible power outlet.
- To prevent internal heat buildup, do not block the ventilation openings.
- Do not install the TV in a hot or humid place, or in a place subject to excessive dust or mechanical vibration.
- Avoid operating the TV at temperatures below 41°F (5°C).
- If the TV is transported directly from a cold to a warm location, or if the room temperature changes suddenly, the picture may be blurred or show poor color due to moisture condensation. In this case, please wait a few hours to let the moisture evaporate before turning on the TV.
- To obtain the best picture, do not expose the screen to direct illumination or direct sunlight. It is recommended to use spot lighting directed down from the ceiling or to cover the windows that face the screen with opaque drapery. It is desirable to install the TV in a room where the floor and walls are not of a reflective material.

CAUTION

Use the following Sony TVs only with the following WALL-MOUNT BRACKET or TV-stand.

| | | Sony TV Model No. | | |
|-----------------------------------|----------|-------------------|------------------------|--------------|
| | | KDL-40XBR4/5 | KDL-46XBR4/5 | KDL-52XBR4/5 |
| Sony Wall-Mount Bracket Model No. | SU-WL500 | | | |
| Sony TV-Stand Model No. | | RHT-G800 | | |
| | | SU-FL300M | SU-FL300M SU-FL300L | SU-FL300L |

Use with other WALL-MOUNT BRACKET or TV-stand may cause instability and possibly result in injury.

To Customers

Sufficient expertise is required for installing the specified TV. Be sure to subcontract the installation to Sony dealers or licensed contractors and pay adequate attention to safety during the installation.

Note

This television includes a QAM demodulator which should allow you to receive unscrambled digital cable television programming via subscription service to a cable service provider. Availability of digital cable television programming in your area depends on the type of programming and signal provided by your cable service provider.

Trademark Information

Macintosh is a trademark of Apple Inc., registered in the U.S. and other countries.

HDMI, the HDMI logo and High-Definition Multimedia Interface are trademarks or registered trademarks of HDMI Licensing LLC.

Manufactured under license from Dolby Laboratories. "Dolby" and the double-D symbol are trademarks of Dolby Laboratories.

Blu-ray Disc is a trademark.

"BRAVIA" and BRAVIA, Motionflow, S-Force, BRAVIA Theatre Sync, DME^x and "x.v. Color" are trademarks or registered marks of Sony Corporation.

"XMB" and "cross media bar" are the trademarks of Sony Corporation and Sony Computer Entertainment Inc.

"PLAYSTATION" is a registered trademark and "PS3" is a trademark of Sony Computer Entertainment Inc.

Adobe is a registered trademark or a trademark of Adobe Systems Incorporated in United States and/or other countries.



Contents

| | |
|-------------------------------------|---|
| Important Safety Instructions | 4 |
|-------------------------------------|---|

Welcome to the World of BRAVIA™

| | |
|---|---|
| The Four Steps to Full HD Experience: Set, Sound, Source, and Setup | 8 |
| Picture Quality and Aspect Ratio | 8 |
| TV Home Menu: XMB™ (Xross Media Bar) | 9 |

Getting Started

| | |
|--|----|
| 1. Installing the TV | 10 |
| Preventing the TV from Toppling Over | 10 |
| Preparation for Wall-Mounting | 10 |
| 2. Locating Inputs and Outputs | 11 |
| Left Side | 11 |
| Rear | 12 |
| 3. Connecting the TV | 14 |
| Cable System or VHF/UHF Antenna System | 14 |
| Cable System and VHF/UHF Antenna System | 14 |
| HD Cable Box/HD Satellite Box | 14 |
| PC | 16 |
| Other Equipment | 17 |
| Using HDMI Control for BRAVIA Theatre Sync™ | 18 |
| Bundling the Connecting Cables | 18 |
| 4. Setting Up the Channel List – Initial Setup | 19 |

Using the TV Features

| | |
|---|----|
| Remote Control and TV Controls/Indicators | 20 |
| Inserting Batteries into the Remote Control | 20 |
| Remote Control and TV Controls | 20 |
| Indicators | 25 |
| Programming the Remote Control | 26 |
| Operating Sony Brand Video Equipment | 26 |
| Programming Non-Sony Video Equipment | 26 |

| | |
|--|----|
| Using Other Equipment with Your Remote Control | 28 |
|--|----|

| | |
|--|----|
| Using P&P and PIP Features | 31 |
| To Display the Sub Window | 31 |
| To Change Inputs or Channels in the Window | 31 |
| To Change the Window Size of P&P | 31 |
| To Exit from P&P and PIP | 31 |

Using the Menus

| | |
|--|----|
| Adjusting TV Settings | 32 |
| Watching TV | 32 |
| Accessing the Equipment Connected to Your TV | 32 |

| | |
|---|----|
| Navigating through TV Home Menu on XMB™ | 33 |
|---|----|

| | |
|-------------------------------------|----|
| TV Setting Description | 34 |
| Product Support | 34 |
| Clock/Timers Settings | 34 |
| Picture Settings | 34 |
| Sound Settings | 36 |
| Screen Settings | 37 |
| Video Options Settings | 39 |
| Audio Options Settings | 40 |
| Channel Settings | 40 |
| Closed Captions (CC) Settings | 41 |
| Parental Lock Settings | 42 |
| External Inputs Settings | 44 |
| HDMI Settings | 44 |
| General Settings | 44 |
| Initial Setup | 45 |

Other Information

| | |
|-----------------------|----|
| Cleaning | 46 |
| Troubleshooting | 46 |
| Specifications | 49 |
| Index | 51 |



Quick Setup Guide (separate volume)
Provides a variety of optional equipment connection diagrams.



Customer Support
<http://www.sony.com/tvsupport>
On-line Registration
United States
<http://productregistration.sony.com>
Canada
<http://www.SonyStyle.ca/registration>

Important Safety Instructions

- 1) Read these instructions.
- 2) Keep these instructions.
- 3) Heed all warnings.
- 4) Follow all instructions.
- 5) Do not use this apparatus near water.
- 6) Clean only with dry cloth.
- 7) Do not block any ventilation openings. Install in accordance with the manufacturer's instructions.
- 8) Do not install near any heat sources such as radiators, heat registers, stoves, or other apparatus (including amplifiers) that produce heat.
- 9) Do not defeat the safety purpose of the polarized or grounding-type plug. A polarized plug has two blades with one wider than the other. A grounding type plug has two blades and a third grounding prong. The wide blade or the third prong are provided for your safety. If the provided plug does not fit into your outlet, consult an electrician for replacement of the obsolete outlet.
- 10) Protect the power cord from being walked on or pinched particularly at plugs, convenience receptacles, and the point where they exit from the apparatus.
- 11) Only use attachments/accessories specified by the manufacturer.
- 12) Use only with the cart, stand, tripod, bracket, or table specified by the manufacturer, or sold with the apparatus. When a cart is used, use caution when moving the cart/apparatus combination to avoid injury from tip-over.
- 13) Unplug this apparatus during lightning storms or when unused for long periods of time.
- 14) Refer all servicing to qualified service personnel. Servicing is required when the apparatus has been damaged in any way, such as power-supply cord or plug is damaged, liquid has been spilled or objects have fallen into the apparatus, the apparatus has been exposed to rain or moisture, does not operate normally, or has been dropped.



USE

AC power cord

Observe the followings to prevent the AC power cord from being damaged. If the AC power cord is damaged, it may result in a fire or an electric shock. Stop using it and ask your dealer or Sony service center to exchange it.

- Do not place the TV where the power cord is subject to wear or abuse.
- Do not pinch, bend, or twist the cord excessively. The core lines may be bared and cut, causing a short-circuit, and resulting in a fire or an electric shock.
- Do not convert or damage the power cord.
- Do not allow anything to rest on or roll over the power cord.
- Do not move the TV with the power cord plugged in.
- Keep the power cord away from heat sources.
- When you disconnect the AC power cord, disconnect it from the wall outlet first.
- Be sure to grasp the plug when disconnecting the power cord. Do not pull the power cord.
- Do not use the supplied AC power cord on any other equipment.
- Use only an original Sony AC power cord, not other brands.



Wall outlet

The TV set with a three-wire grounding type AC power cord plug must be connected to an AC power socket outlet with a protective earthing connection.

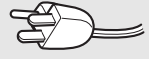

Do not use a poor fitting outlet.

Insert the plug fully into the outlet. If it is loose, it may cause arcing and result in a fire.

Contact your electrician to have the outlet changed.



Wiring

When connecting cables, be sure to unplug the AC power cord for your safety.

Take care not to catch your feet on the cables. It may damage the TV set.

Electric shock

Do not touch the AC power cord or the TV with a wet hand. If you plug/unplug the AC power cord from the TV with a wet hand, it may cause electric shock.



Lightning storms

For added protection for this TV during a lightning storm, or when it is left unattended and unused for long periods of time, unplug it from the wall outlet and disconnect the antenna. This will prevent damage to the TV due to lightning and power line surges.



When not in use

If you will not be using the TV set for several days, the TV set should be disconnected from the AC power outlet for environmental and safety reasons. The TV set is not disconnected from the AC power source when the TV set is switched off. To disconnect the TV set completely, pull the plug from the AC power outlet.

Overloading

This TV set is designed to operate on a 120 - 240 V AC supply only. Take care not to connect too many appliances to the same AC power outlet as this could result in a fire or an electric shock.

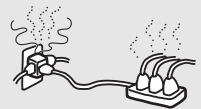

Optional equipment

Do not install optional equipment too close to the TV set. Picture distortion and/or noisy sound may occur if the TV set is positioned in close proximity to any equipment emitting electromagnetic radiation.

Small accessories

Keep small accessories out of children's reach.

ANTENNAS

Outdoor antenna grounding

If an outdoor antenna is installed, follow the precautions below. An outdoor antenna system should not be located in the vicinity of overhead power lines or other electric light or power circuits, or where it can come in contact with such power lines or circuits.

WHEN INSTALLING AN OUTDOOR ANTENNA SYSTEM, EXTREME CARE SHOULD BE TAKEN TO KEEP FROM CONTACTING SUCH POWER LINES OR CIRCUITS AS CONTACT WITH THEM IS ALMOST INVARIABLY FATAL.

Be sure the antenna system is grounded so as to provide some protection against voltage surges and built-up static charges.

Section 810 of the National Electrical Code (NEC) in the U.S.A. and Section 54 of the Canadian Electrical Code in Canada provides information with respect to proper grounding of the mast and supporting structure, grounding of the lead-in wire to an antenna discharge unit, size of grounding conductors, location of antenna discharge unit, connection to grounding electrodes, and requirements for the grounding electrode.

Antenna grounding according to the National Electrical Code, ANSI/NFPA 70

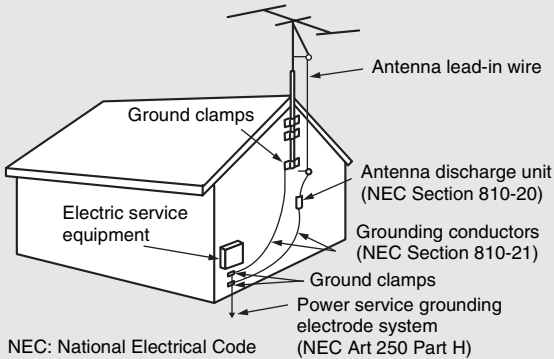

BATTERIES

- Do not dispose of batteries in a fire.
- Do not short circuit, disassemble or overheat the batteries.
- Danger of explosion if battery is incorrectly replaced. Replace only with the same or equivalent type.

Disposal of used batteries

To preserve our environment, dispose of used batteries according to your local laws or regulations.

CLEANING

Cleaning the AC power plug

Unplug the AC power plug and clean it regularly. If the plug is covered with dust and it picks up moisture, its insulation may deteriorate and result in a fire.



Cleaning the screen surface/ cabinet of the TV set

Unplug the AC power cord when cleaning this TV. If not, it may result in electric shock. Clean the cabinet of the TV with a dry soft cloth. To remove dust from the screen, wipe it gently with a soft cloth. Stubborn stains may be removed with a cloth slightly dampened with a solution of mild soap and warm water. Never use strong solvents such as thinner or benzene for cleaning. If using a chemically pretreated cloth, please follow the instruction provided on the package. The ventilation holes can accumulate dust over time. To ensure proper ventilation, we recommend removing the dust periodically (once a month) using a vacuum cleaner.



MAGNETIC INFLUENCE

This TV contains a strong magnet in the speaker unit that generates a magnetic field. Keep any items susceptible to magnetic fields away from the speaker.

SOUND

If a snapping or popping sound from the TV is continuous or frequent while the TV is operating, unplug the TV and consult your dealer or service technician. It is normal for some TV's to make occasional snapping or popping sounds, particularly when being turned on or off.

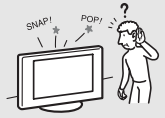

CARRYING THE TV

Carry the TV in the specified manner

To avoid dropping the TV and causing serious injury, be sure to follow these guidelines:

- Before carrying the TV, disconnect all cables.
- Carrying the large size TV requires at least two or three people.
- When you carry the TV, place your hand as illustrated and hold it securely. Do not put stress on the LCD panel and the frame around the screen.
- When carrying the TV, do not subject it to shocks or vibration, or excessive force.

KDL-40XBR4/
KDL-46XBR4/
KDL-40XBR5/
KDL-46XBR5

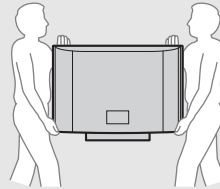

KDL-52XBR4/
KDL-52XBR5

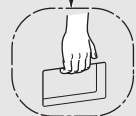
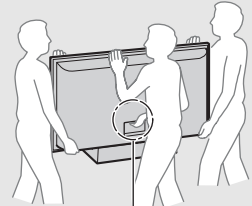

- When lifting or moving the TV, hold it firmly from the bottom. Place your palm directly under the panel.

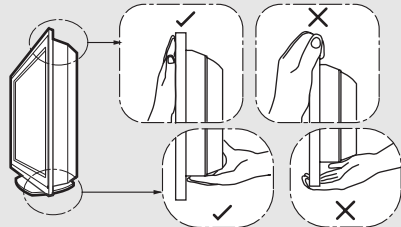

(Continued)

VENTILATION

The slots and openings in the TV are provided for necessary ventilation. To ensure reliable operation of the TV and to protect it from overheating, these slots and openings must never be blocked or covered.

Unless proper ventilation is provided, the TV may gather dust and get dirty. For proper ventilation, observe the following:

- Do not install the TV face up, down or sideways.
- Do not install the TV turned over or upside down.
- Never cover the slots and openings with a cloth or other materials.



- Never block the slots and openings by placing the TV on a bed, sofa, rug or other similar surface.



- Never place the TV in a confined space, such as a bookcase or built-in cabinet, unless proper ventilation is provided.

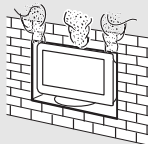

Leave some space around the TV set as shown below. Otherwise, air-circulation may be inadequate and cause overheating, which may cause a fire or damage to the TV set.

Installed on the wall

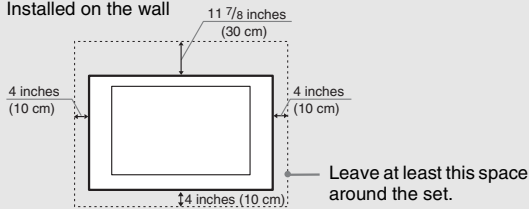

Installed with stand

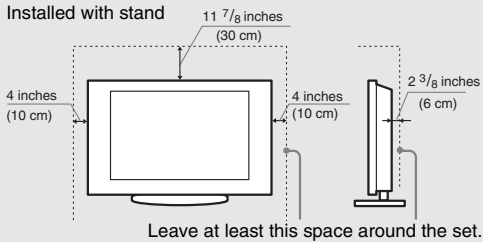

Never install the TV set as follows:

Air circulation is blocked.

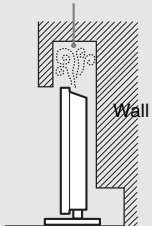

Air circulation is blocked.

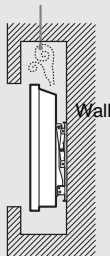

Objects and ventilation holes

Never push objects of any kind into the TV through the cabinet slots as they may touch dangerous voltage points or short out parts that could result in a fire or an electric shock. Do not place any objects on the TV.



MOISTURE

Moisture and flammable objects

- The TV must not be exposed to dripping or splashing. Do not place objects filled with liquids, such as vases, on the TV.
- Do not use power-line operated TV sets near water — for example, near a bathtub, washbowl, kitchen sink, or laundry tub, in a wet basement, or near a swimming pool, etc. It may result in a fire or an electric shock.
- Do not let this TV get wet. Never spill liquid of any kind on the TV. If any liquid or solid object does fall through, do not operate the TV. It may result in electric shock or damage to the TV. Have it checked immediately by qualified personnel.
- To prevent fire, keep flammable objects or open flame (e.g. candles) away from the TV.



INSTALLATION

Wall mount installation requires the use of a Wall-Mount Bracket. When installing or removing the TV, using the Wall-Mount Bracket, be sure to use qualified contractors. If not properly secured during installation or removal from the Wall-Mount Bracket, the TV may fall and cause serious injury.

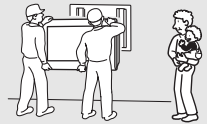

Optional wall mount

Observe the following when installing the TV using a Wall-Mount Bracket.

- Be sure to follow the operating instructions supplied with the Wall-Mount Bracket when installing the TV.
- Be sure to attach the brackets supplied with the Wall-Mount Bracket.
- Do not hang the TV from the ceiling. It may fall and cause serious injury.

Placement

The TV should be installed near an easily accessible AC power outlet.

Observe the following in placing the TV. Otherwise the TV may fall from the stand or wall mount, causing damage or serious injury.

- Place the TV on a stable, level surface.
- Do not hang anything on the TV. Do not allow children to climb on the TV.



Do not install the TV in places subject to extreme temperature, such as in direct sunlight, near a radiator, or heating vent. If the TV is exposed to extreme temperature, the TV may overheat and cause deformation of the enclosure or cause the TV to malfunction. Do not install the TV in a place exposed to direct air conditioning. If the TV is installed in such a location, moisture may condense inside and may cause a malfunction.

- Never place the TV in hot, oily, humid or excessively dusty places.
- Do not install the TV where insects may enter.
- Do not install the TV where it may be exposed to mechanical vibration.



- Do not install the TV in a location where it may protrude, such as on or behind a pillar, or where you might bump your head on it. Otherwise, it may result in injury.

Preventing the TV from toppling over

Take measures to prevent the TV from toppling over and causing injury. To prevent the TV from toppling over, secure the TV to a wall or stand.

Placement for viewing

It is recommended to watch the TV at a distance of 3 - 7 times that of the screen height, and in moderate brightness. Watching the TV for too long or in a dark room may cause eye fatigue. To obtain a clear picture, do not expose the screen to direct illumination or direct sunlight. If possible, use spot lighting directed down from the ceiling.

Outdoor use

Do not install this TV outdoors. If the TV is exposed to rain, it may result in a fire or an electric shock. Do not expose the TV to direct sunlight, it may heat up and become damaged.



Vehicle, ships and other vessels

Do not install this TV in a vehicle.

Bumping of the vehicle may cause the TV to fall down and cause injury.



Do not install this TV in a ship or vessel. If the TV is exposed to seawater, it may cause a fire or damage the TV.



Medical institutions

Do not place this TV in a place where medical equipment is in use.

It may cause a malfunction of medical equipment.



VOLUME ADJUSTMENT

- Adjust the volume so as not to trouble your neighbors. Sound carries very easily at night. Therefore, closing the windows or using headphones is suggested.
- When using headphones, adjust the volume so as to avoid excessive levels, as hearing damage may result.

LCD SCREEN

- Although the LCD screen is made with high-precision technology and has effective pixels of 99.99% or more, black dots or bright points of light (red, blue, or green) may appear constantly on the LCD screen. This is a structural property of the LCD panel and is not a malfunction.
- The LCD screen is made with high-precision technology and to achieve a high level of performance and picture quality, this TV's backlight setting is set to maximize the brightness of the TV. However, uneven brightness may be observed when the LCD TV is viewed in a dark ambient without an input source or a blank screen. This condition is normal and not a malfunction of the TV. Changing the Picture mode, Backlight setting, enabling the Light Sensor, or turning on the Power management will improve this condition.
- Do not expose the LCD screen surface to direct sunlight. Doing so may damage the LCD panel.
- Do not push or scratch the LCD screen, or place objects on top of the TV. The image may be uneven or the LCD panel may be damaged.
- If the TV is used in a cold place, a smear may occur in the picture or the picture may become dark. This does not indicate a failure. These phenomena improve as the temperature rises.
- Ghosting may occur when still pictures are displayed continuously. It should disappear after a few moments.
- The screen and cabinet get warm when the TV is in use. This is not a malfunction.
- Avoid spraying insect repellent with volatile material on the screen.
- Avoid prolonged contact with rubber or plastic material.

Broken pieces

Do not throw anything at the TV.

The screen glass may break by the impact and cause serious injury.



If the surface of the TV cracks, do not touch it until you have unplugged the AC power cord.

Otherwise electric shock may result.

Handling of broken glass and liquid crystal leakage

If the LCD panel gets damaged, crystalline liquid leakage may occur, or scattered broken glass may result. Do not touch broken glass or crystalline liquid which is toxic, with bare hands as cuts, poisoning or skin irritation may occur. Also, do not let glass fragments or leaked crystalline liquid get into your eyes or mouth. Should either contact your eyes or mouth, rinse the contacted area thoroughly with water and consult your doctor.

SERVICING

Do not attempt to service the TV yourself since opening the cabinet may expose you to dangerous voltage or other hazards. Refer all servicing to qualified service personnel.



Replacement parts

When replacement parts are required, be sure the service technician certifies in writing that he/she has used replacement parts specified by the manufacturer that have the same characteristics as the original parts.

Unauthorized substitutions may result in a fire, an electric shock or other hazards.



Safety check

Upon completion of any service or repairs to the TV, ask the service technician to perform routine safety checks (as specified by the manufacturer) to determine that the TV is in safe operating condition, and to so certify. Ask a qualified service technician to dispose of the TV.



For Customers in the United States

Lamp in this product contains mercury. Disposal of these materials may be regulated due to environmental considerations. For disposal or recycling information, please contact your local authorities or the Electronic Industries Alliance (<http://www.eia.org>).

Welcome to the World of BRAVIA™

Thank you for purchasing this Sony BRAVIA™ high-definition television. The quality of the image you see on your BRAVIA TV is only as good as the quality of the signal it receives. To experience the full detail of your new BRAVIA TV, you need access to HD programming. Your BRAVIA TV can receive and display HD programming from:

- Over-the-air broadcasting via HD-quality antenna
- HD cable subscription
- HD satellite subscription
- Blu-ray Disc™ Player or other external equipment

Contact your cable or satellite provider for information on upgrading to HD programming.

To learn more about HDTV, visit: <http://www.sony.com/HDTV>

The Four Steps to Full HD Experience: Set, Sound, Source, and Setup

Along with your BRAVIA TV **set**, a complete HD system requires an HD **sound** system, a **source** of HD programming and proper **setup** connections. This manual explains basic setup connections (see page 14). The Quick Setup Guide, enclosed separately, illustrates how to connect other optional equipment.

Picture Quality and Aspect Ratio

You can enjoy crisp, clear images, smooth movement and high-impact visuals from 1080 HD signals. When you compare a high-definition signal to a standard analog signal, you will notice a big difference. The 1080 HD signals provide more than twice the vertical resolution of the standard TV signal.

High-definition and standard-definition signals are transmitted with different aspect ratios (the width-to-height ratio of the image). HDTV uses a wider screen than conventional standard-definition TV.

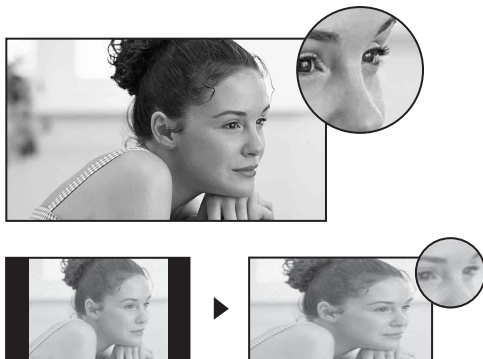

16:9 (high-definition) source

Most HDTV signals use a wide screen aspect ratio of 16:9. The 16:9 fills your BRAVIA screen and maintains a crisp, clear, vivid picture.

4:3 (standard-definition) source

Most standard-definition signals use a boxy 4:3 aspect ratio. When a 4:3 image is displayed on an HDTV, you will see black bars on the sides. The picture quality may not be as sharp as with HD sources.



- You can use the **Wide Mode** function of the TV to adjust the 4:3 image to fit the entire screen (see pages 23, 37 and 38).

TV Home Menu: XMB™ (Xross Media Bar)

The **XMB™** is a menu of BRAVIA features and input sources displayed on the TV screen. The **XMB™** is an easy way to select programming and adjust settings on your BRAVIA TV. Press the **HOME** button on your remote control to access the **XMB™**.

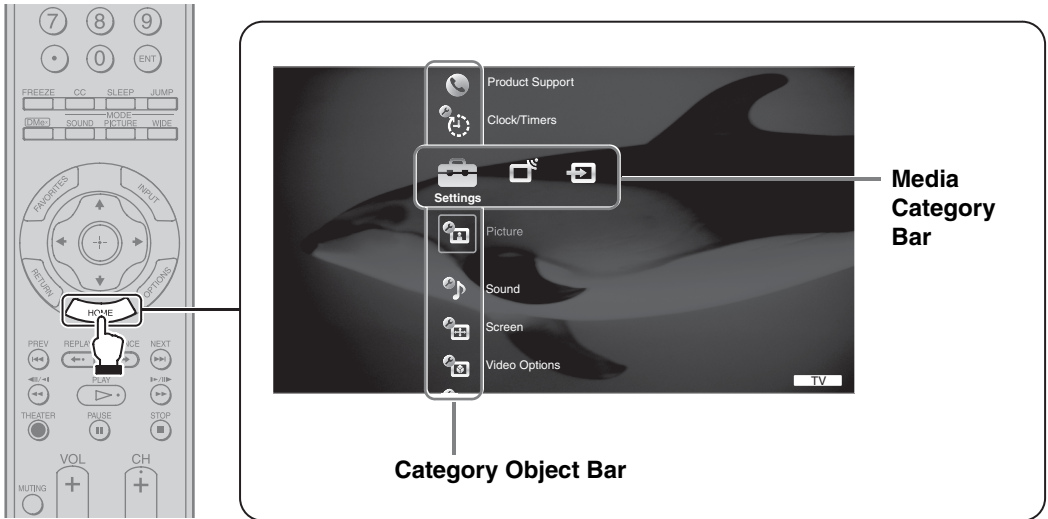

From the horizontal Media Category Bar you can control:

- **Settings:** timer, picture, sound, screen and other options (see page 34 for customization options).
- **TV Channels:** available channels are displayed on the vertical Category Object Bar.
- **External Inputs:** cable, satellite, VCR, DVD players or other inputs can also be selected from the Category Object Bar for the **External Inputs**.



• This manual is for the 40, 46 and 52 inch BRAVIA KDL-X Series models with screen size measured diagonally.

Getting Started

1. Installing the TV

Preventing the TV from Toppling Over

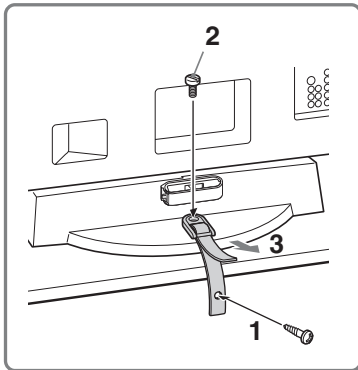
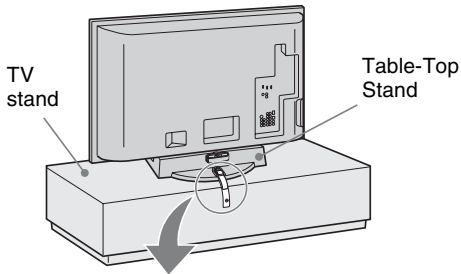

- 1 Screw the support belt (supplied) to the TV stand with a wood screw (supplied).
- 2 Attach the support belt to the Table-Top Stand with the securing screw (supplied) using a coin, etc.
- 3 Adjust the length by pulling the support belt toward you while holding the Table-Top Stand.



- Be sure to take measures to prevent the TV from toppling over and causing injury.
- The supplied wood screw may not be used depending on the type of TV stand. In this case, or when the securing strength is not enough, use commercial screws $\frac{1}{8}$ to $\frac{3}{16}$ inch (3 to 4 mm) diameter to fit to the TV stand. Consult your dealer about the types of screw(s).

To Replace the Bezel Unit

The bezel unit can be replaced with others that are sold separately. However, do not remove the unit except to replace it. For details, see the instructions supplied with bezel units.

Preparation for Wall-Mounting

This TV can be installed on a wall by using a Wall-Mount Bracket (sold separately). Before mounting the TV on a wall, the Table-Top Stand must be removed from the TV.

Follow the simple steps below to remove the Table-Top Stand:

- 1 Disconnect all the cables from the TV.
- 2 Start removing the screws behind the TV (See illustration below).
Do not remove any other screws from the TV.
- 3 When screws are removed, lift the TV off the stand. Make sure that you carry out this task with at least two or three people. Do not attempt to lift the TV by yourself.





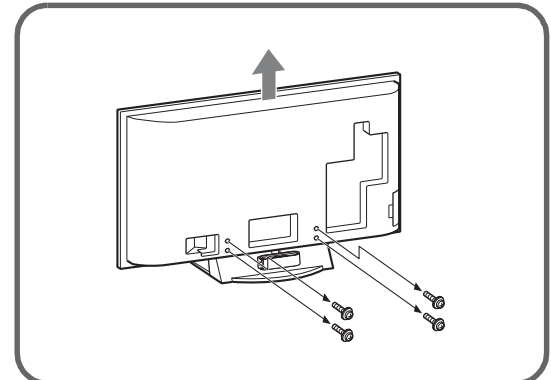

- Do not remove the Table-Top Stand for any reason other than to wall-mount the TV.
- When using an electric screwdriver, set the torque setting to approximately 2 N·m {20 Kgf·cm}.
- Be sure to store the removed screws and Table-Top Stand in a safe place until you are ready to reattach the Table-Top Stand. Keep the screws away from small children.
- For bracket installation, refer to the supplied **Installing the Wall-Mount Bracket** and the instruction guide provided by the Wall-Mount Bracket model for your TV. Sufficient expertise is required in installing this TV, especially to determine the strength of the wall for withstanding the TV's weight.
- **For product protection and safety reasons, Sony strongly recommends that you use the Wall-Mount Bracket model designed for your TV and that the wall-mounting of your TV is performed by a Sony dealer or licensed contractor.**



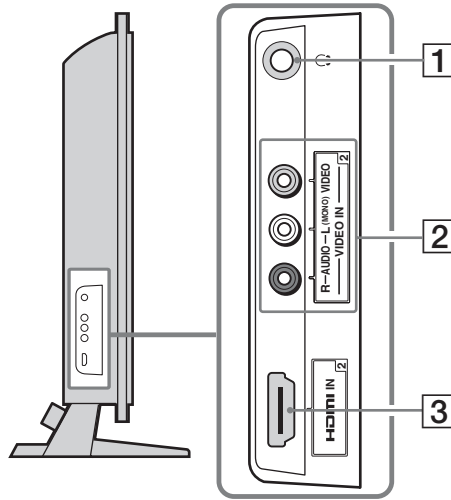

2. Locating Inputs and Outputs

Left Side

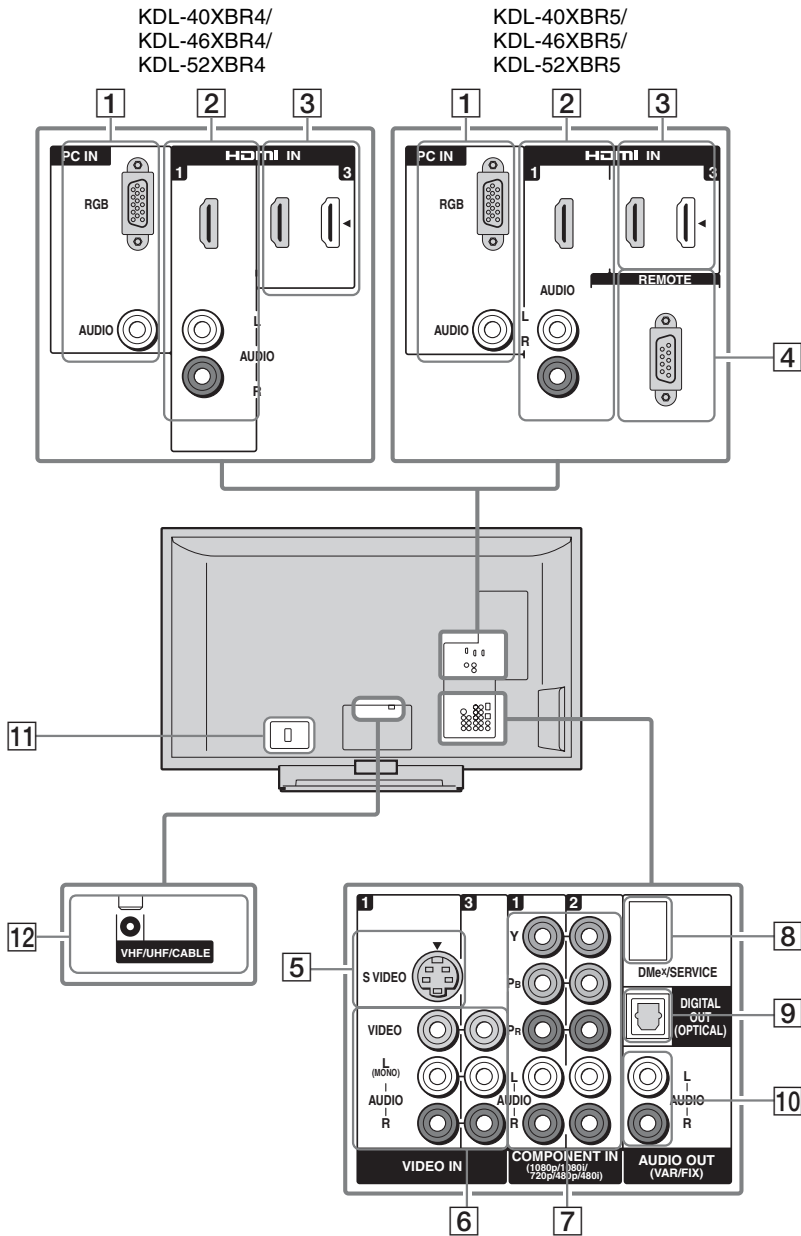

| Item | Description |
|--|--|
| 1 Headphone jack | <p>Connects to your headphones. If your headphones do not match the jack, use a suitable plug adapter (not supplied).</p> <p></p> <ul style="list-style-type: none"> • While headphones are connected, the TV speakers are muted. |
| 2 VIDEO IN 2 VIDEO/R-AUDIO-L (MONO) | <p>Connects to the composite video and audio output jacks on your camcorder or other video equipment such as a VCR or video game equipment.</p> <p></p> <ul style="list-style-type: none"> • If you have mono equipment, connect its audio output jack to the TV's L (MONO) audio input jack. |
| 3 HDMI IN 2 HDMI | <p>HDMI (High-Definition Multimedia Interface) provides an uncompressed, all-digital audio/video interface between this TV and any HDMI-equipped audio/video equipment, such as a set-top box, DVD player, Blu-ray Disc Player, A/V receiver as well as PC. HDMI supports enhanced, or high-definition video, plus digital audio.</p> <p></p> <ul style="list-style-type: none"> • HDMI connection is necessary to view 480i, 480p, 720p, 1080i, 1080p and 1080/24p formats. Note that this TV displays all video input signals in a resolution of 1,920 dots × 1,080 lines. • Be sure to use only an HDMI cable that bears the HDMI logo. • When HDMI control compatible equipment is connected, communication with the connected equipment is supported. Refer to page 44 to set up this communication. • When connecting a HDMI control compatible audio system with HDMI jack, be sure to also connect to the OPTICAL OUT jack. |

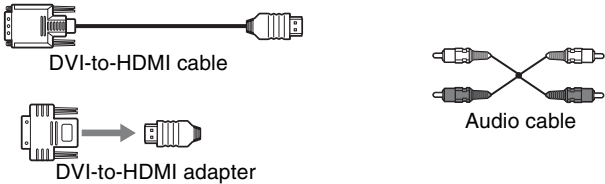

| Item | Description |
|---------------------|--|
| 1 PC IN (RGB/AUDIO) | <p>Connects to a personal computer's video output connector using a HD15-HD15 cable with ferrite core (analog RGB, not supplied). Can also be connected to other analog RGB equipment. See "PC Input Signal Reference Chart" on page 16 for the signals that can be displayed.</p> <p></p> <ul style="list-style-type: none"> For some Apple Macintosh computers, it may be necessary to use an adapter (not supplied). If this is the case, connect the adapter to the computer before connecting the HD15-HD15 cable with ferrite core. If the picture is noisy, flickering or not clear, adjust Phase and Pitch of Screen settings on page 38. |

| Item | Description |
|--|---|
| 2 HDMI IN 1 HDMI/ R-AUDIO-L | HDMI (High-Definition Multimedia Interface) provides an uncompressed, all-digital audio/video interface between this TV and any HDMI-equipped audio/video equipment, such as a set-top box, DVD player, Blu-ray Disc Player, A/V receiver as well as PC. HDMI supports enhanced, or high-definition video, plus digital audio. |
| 3 HDMI IN 3 HDMI | If the equipment has a DVI jack and not an HDMI jack, connect the DVI jack to the HDMI IN 1 (with DVI-to-HDMI cable or adapter) jack, and connect the audio jack to the AUDIO IN (L/R) jacks of HDMI IN 1. |
| |  <p>The diagram illustrates three types of cables used for connecting external equipment to the TV's HDMI ports. On the left, a 'DVI-to-HDMI cable' is shown as a long cable with a DVI connector on one end and an HDMI connector on the other. Below it, a 'DVI-to-HDMI adapter' is shown as a small device with a DVI port on one side and an HDMI port on the other. On the right, an 'Audio cable' is shown as a cable with two RCA connectors (red and white) on both ends.</p> |
| | <ul style="list-style-type: none"> • HDMI connection is necessary to view 480i, 480p, 720p, 1080i, 1080p and 1080/24p formats. Note that this TV displays all video input signals in a resolution of 1,920 dots × 1,080 lines. • Be sure to use only an HDMI cable that bears the HDMI logo. • When HDMI control compatible equipment is connected, communication with the connected equipment is supported. Refer to page 44 to set up this communication. • When connecting a HDMI control compatible audio system with HDMI jack, be sure to also connect to the OPTICAL OUT jack. |
| 4 REMOTE (KDL-40/46/52XBR5 only) | This jack is for receiving the external control signal. |
| 5 VIDEO IN 1 S VIDEO | Connects to the S VIDEO output jack of your VCR or other video equipment that has S VIDEO. S VIDEO provides better picture quality than composite video ([6]) connection. If both composite video and S VIDEO are connected, S VIDEO signal has priority. |
| 6 VIDEO IN 1/3 VIDEO/L(MONO)- AUDIO-R | Connects to the composite video and audio output jacks on your A/V equipment such as a VCR or other video equipment. A third composite video and audio (VIDEO IN 2) is located on the left side of the TV. |
| 7 COMPONENT IN 1/2 (1080p/1080i/ 720p/480p/480i)/ L-AUDIO-R | Connects to your equipment's component video (YPbPr) and audio (L/R) jacks. Component video provides better picture quality than the S VIDEO ([5]) or the composite video ([6]) connection. |
| | <ul style="list-style-type: none"> • Component video (YPbPr) connection is necessary to view 480i, 480p, 720p, 1080i and 1080p formats. Note that this TV displays all video input signals in a resolution of 1,920 dots × 1,080 lines. |
| 8 DMe^x/ SERVICE | This USB port is for service only unless you are connecting the optional BRAVIA external module (DMe ^x). |
| 9 DIGITAL OUT (OPTICAL) | Connects to the optical audio input of your digital audio equipment that is PCM/Dolby Digital compatible. Dolby Digital Audio signal from the HDMI input will be output as PCM. |
| 10 AUDIO OUT (VAR/FIX) | Connects to the left and right audio input jacks of your analog audio equipment. You can use these outputs to listen to your TV's audio through your stereo system. |
| 11 AC IN | Connects the supplied AC power cord. |
| 12 VHF/UHF/CABLE | RF input that connects to your Cable or VHF/UHF antenna. |

3. Connecting the TV

Cable System or VHF/UHF Antenna System

You can enjoy high-definition and standard-definition digital programming (if available in your area) along with standard-definition analog programming.



- This TV is capable of receiving unscrambled digital programming for both cable (QAM and 8VSB) and external VHF/UHF antenna (ATSC).
- It is strongly recommended that you connect the antenna/cable input using the 75-ohm coaxial cable (not supplied) to receive optimum picture quality. A 300-ohm twin lead cable can be easily affected by radio frequency interference, resulting in signal degradation.

Cable or VHF/UHF (or VHF only)

75-ohm coaxial cable  Rear of TV
VHF/UHF/CABLE input

Cable System and VHF/UHF Antenna System

Use an optional A-B RF switch (not supplied) to switch between the cable and over-the-air antenna programming, as indicated below.

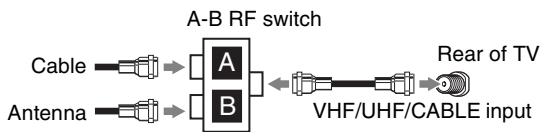

- Be sure to set the **Cable** setting to **On** or **Off** in the **Channel** settings for the type of input signal you choose (see page 40).

HD Cable Box/HD Satellite Box

You can also enjoy high-definition programming by subscribing to a high-definition cable service or a high-definition satellite service. For the best possible picture, make sure you connect this equipment to your TV via the HDMI or component video (with audio) input on the back of your TV.

Shown with HDMI Connection

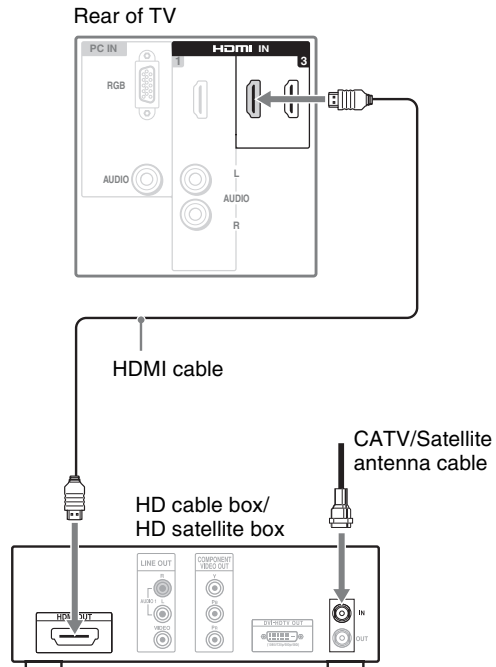

Shown with DVI Connection

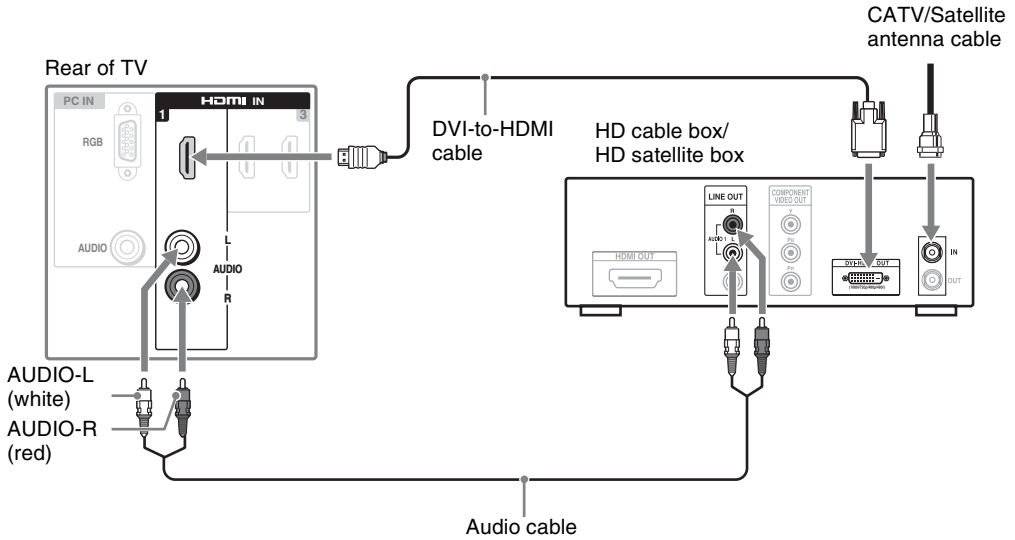

- If the equipment has a DVI jack and not an HDMI jack, connect the DVI jack to the HDMI IN 1 (with DVI-to-HDMI cable or adapter) jack and connect the audio jack to the AUDIO IN (L/R) jacks of HDMI IN 1. For details, see page 13.

Shown with Component Connection

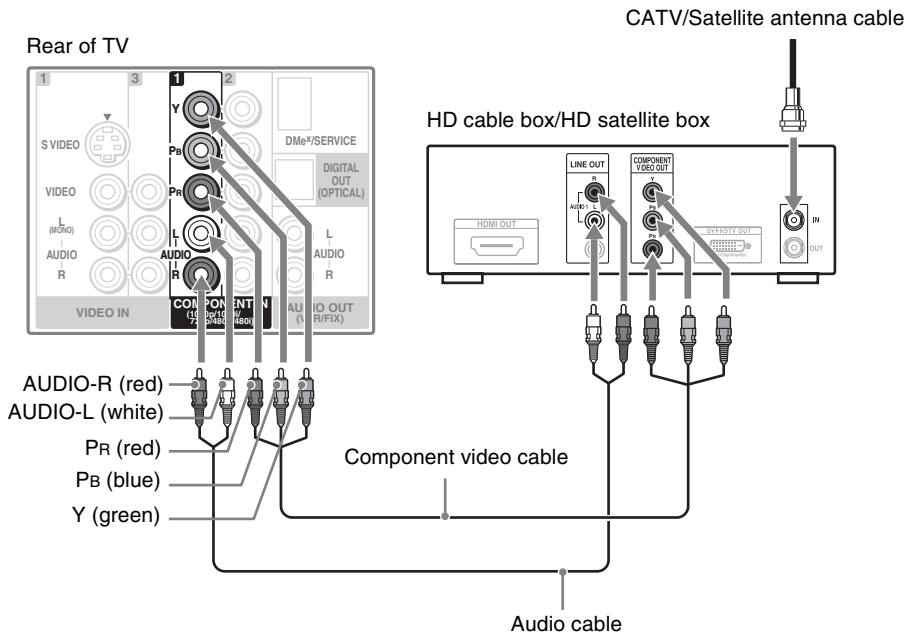

PC

Use the TV as a monitor for your PC.

Shown below with the HD15 to HD15 connection. This TV can also be connected to a PC with DVI or HDMI output. (Refer to the separate Quick Setup Guide.)

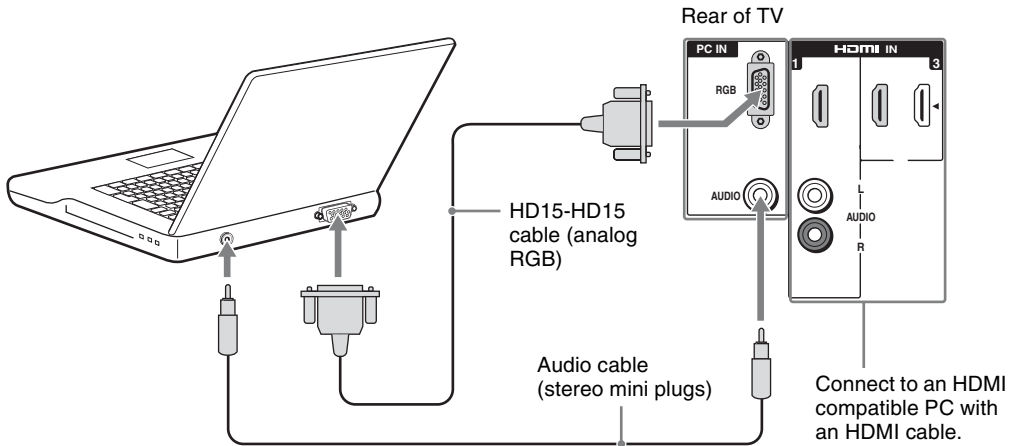

- Connect the PC IN jack to the PC using the HD15-HD15 cable with ferrite core (analog RGB, not supplied) and audio cable (page 12).
- If the PC is connected to the TV and no signal has been input from the PC for more than 30 seconds, the TV enters the standby mode automatically (page 45).

PC Input Signal Reference Chart

After connecting the PC to the TV, set the output signal from the PC according to the chart below.

| Resolution Signals | Horizontal (Pixel) | x | Vertical (Line) | Horizontal frequency (kHz) | Vertical frequency (Hz) | Standard |
|---------------------------|---------------------------|----------|------------------------|-----------------------------------|--------------------------------|------------------------|
| VGA | 640 | x | 480 | 31.5 | 60 | VGA |
| | 640 | x | 480 | 37.5 | 75 | VESA |
| | 720 | x | 400 | 31.5 | 70 | VGA-T |
| SVGA | 800 | x | 600 | 37.9 | 60 | VESA Guidelines |
| | 800 | x | 600 | 46.9 | 75 | VESA |
| XGA | 1024 | x | 768 | 48.4 | 60 | VESA Guidelines |
| | 1024 | x | 768 | 56.5 | 70 | VESA |
| | 1024 | x | 768 | 60.0 | 75 | VESA |
| WXGA | 1280 | x | 768 | 47.4 | 60 | VESA |
| | 1280 | x | 768 | 47.8 | 60 | VESA |
| | 1280 | x | 768 | 60.3 | 75 | |
| | 1360 | x | 768 | 47.7 | 60 | VESA |
| SXGA | 1280 | x | 1024 | 64.0 | 60 | VESA |
| | 1280 | x | 1024 | 80.0 | 75 | VESA |
| HDTV | 1920 | x | 1080 | 67.5 | 60 | |



- This TV's PC input does not support Sync on Green or Composite Sync.
- This TV's PC VGA input does not support interlaced signals.
- For the best picture quality, it is recommended to use the signals (boldfaced) in the above chart with a 60 Hz vertical frequency from a personal computer. In plug and play, signals with a 60 Hz vertical frequency will be detected automatically. (PC reboot may be necessary.)

Other Equipment

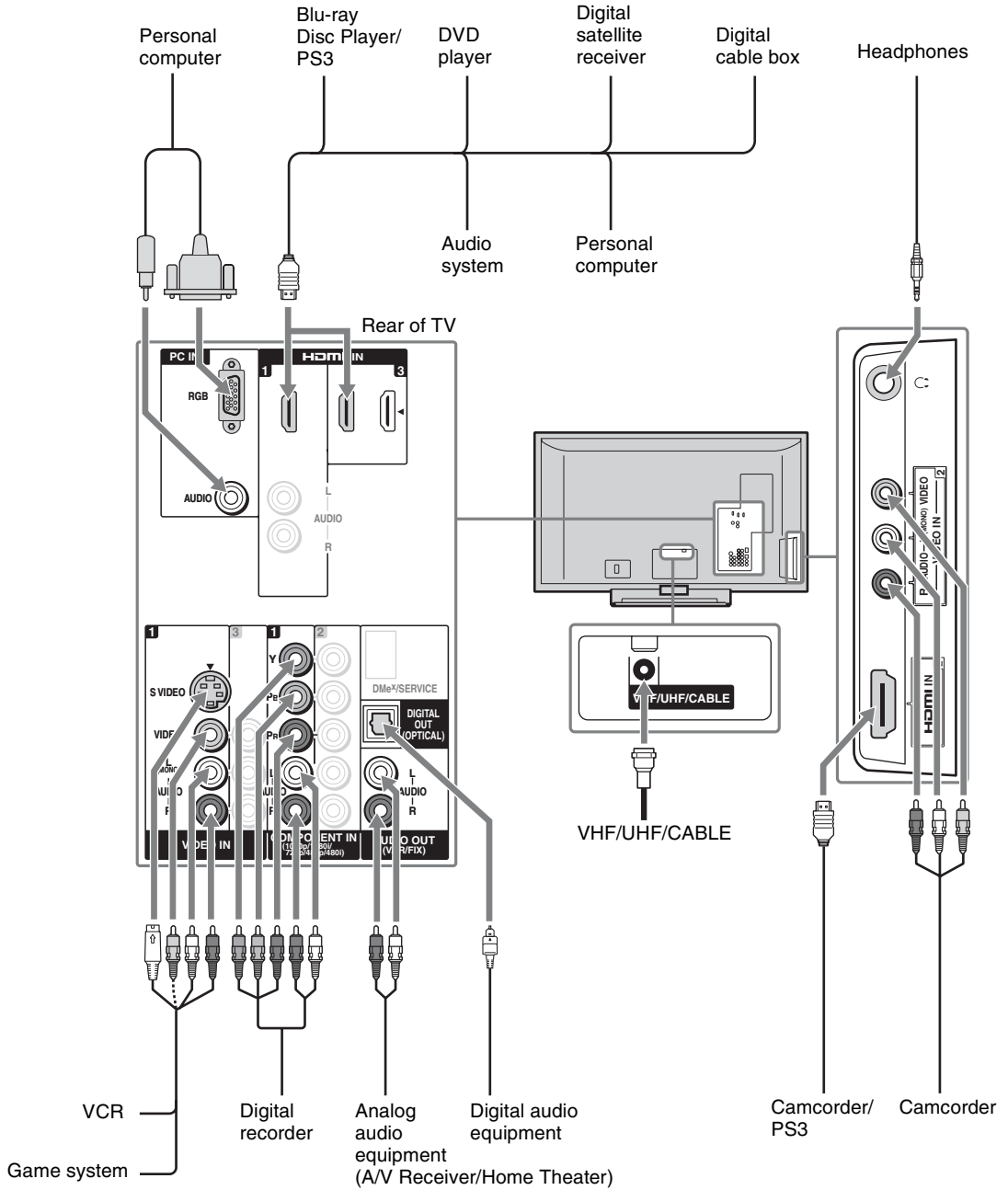

- Refer to the Quick Setup Guide (supplied) when connecting other equipment to your TV.

Using HDMI Control for BRAVIA Theatre Sync™

This TV is equipped with BRAVIA Theatre Sync. The HDMI Control function enables BRAVIA Theatre Sync to allow communication between Sony TV's and Sony equipment. Only Sony equipment with HDMI Control capability is supported.

To Connect HDMI Control Equipment

Use an HDMI cable that bears the HDMI logo for connection. See page 17 or see the HDMI connection shown in the Quick Setup Guide provided with the TV documentation.

Setting the HDMI Control

In order for the HDMI Control function to operate, the TV and other Sony HDMI Control equipment must be setup. See page 44 on how to turn the **HDMI Control On**. For other equipment, refer to the operating instruction for that equipment.

HDMI Control Available with Your TV

Once the supported equipment is connected, the following operations are available:

- Turn off the equipment automatically when you turn off the TV.
- When the connected equipment is turned on by One-Touch-Play, the TV will automatically turn on and select the respective HDMI input.
- Automatically turn on equipment listed under the **External Inputs** on the **XMB™** when selected, see pages 9 and 32.

When a Sony A/V receiver with BRAVIA Theatre Sync is connected, the following additional operations are possible:

- Turning on the A/V receiver when the TV is turned on.
- Automatically switching to the audio output of the A/V receiver's attached speakers.
- Adjusting the volume and muting of the A/V receiver with the TV's remote control.



- The A/V receiver cannot be selected from the **XMB™**.

Bundling the Connecting Cables

You can bundle the connecting cables as illustrated below.

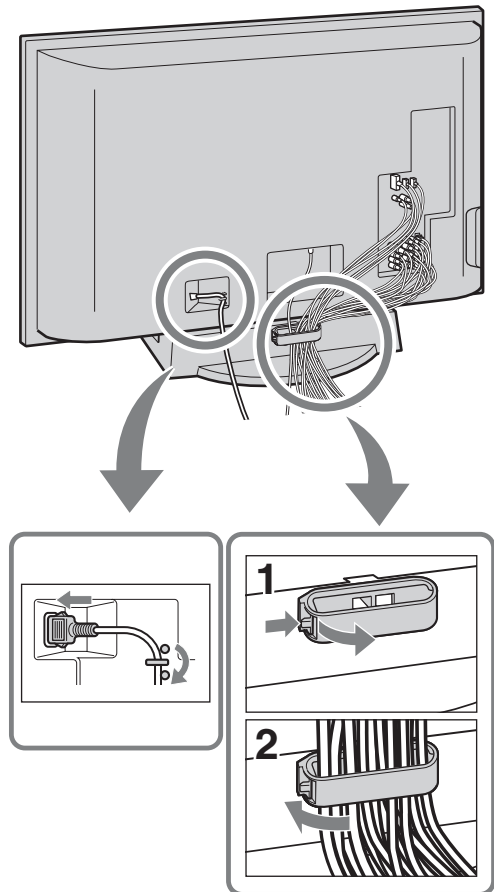

- Do not bundle the AC power cord with other connecting cables.
- The hook of the cable holder can be opened from either sides depending on attaching position.

4. Setting Up the Channel List – Initial Setup

The **Initial Setup** screen appears when you turn on the TV for the first time.

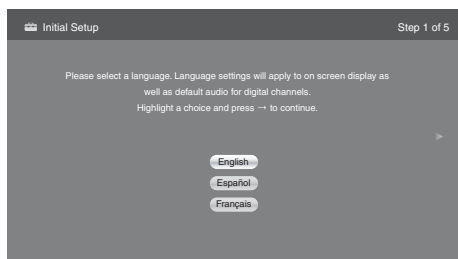

After you finish connecting the TV, you can run **Initial Setup** to create a list of available analog and digital channels if you have connected an antenna or cable directly to the TV's VHF/UHF/CABLE input.

You will be prompted to select the language of your choice to be used for all the on-screen settings.

Use the remote control to navigate through the **Initial Setup**:

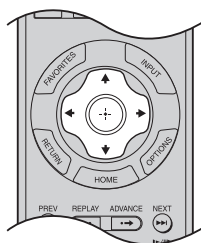

↑/↓ button:
Allows you to highlight options where applicable.

⊕ button:
Allows you to select the highlighted option and advance to the next screen.

← button:
Allows you to move back to the previous screen.

→ button:
Allows you to move to the next screen.

Follow the help text provided on the screen to run **Auto Program** with the connected signal source or select **Skip** to skip the **Auto Program** if you are receiving channels from a cable box or satellite receiver and the VHF/UHF/CABLE input is not connected. The **Auto Program** will scan for available channels. When the **Auto Program** is completed, the TV will display how many analog and digital channels are found.



- If you accidentally turn off the TV during the **Initial Setup** process, the **Initial Setup** will restart from the beginning when the TV is turned back on.
- The **Auto Program** may be canceled while the channels are being scanned. Press **RETURN** first then press either **←/→** on the remote control, highlight “Yes” to cancel or “No” to resume **Auto Program**.

To Run Initial Setup Again or Auto Program at a Later Time

Select the **Initial Setup** feature from the **XMB™** or refer to the **Initial Setup** described on page 45. To run **Auto Program**, see page 40.

To Add Digital Channels

Use the **Add Digital Channels** feature as described on page 40. (Useful for antenna installations.)

To Display the Picture in Your Preferred Aspect Ratio

Select the proper **Wide Mode** as described on pages 37 and 38.

You may want to set up convenient features such as **Favorites** (see page 21), **Show/Hide Channels** (page 41), **Edit Channel Labels** (page 41) when **Auto Program** is completed.

Using the TV Features

Remote Control and TV Controls/Indicators

Inserting Batteries into the Remote Control

Insert two size AA batteries (supplied) by matching **+** and **-** on the batteries to the diagram inside the battery compartment of the remote control.

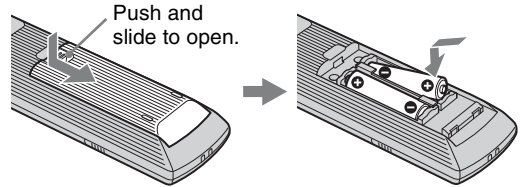

Remote Control and TV Controls

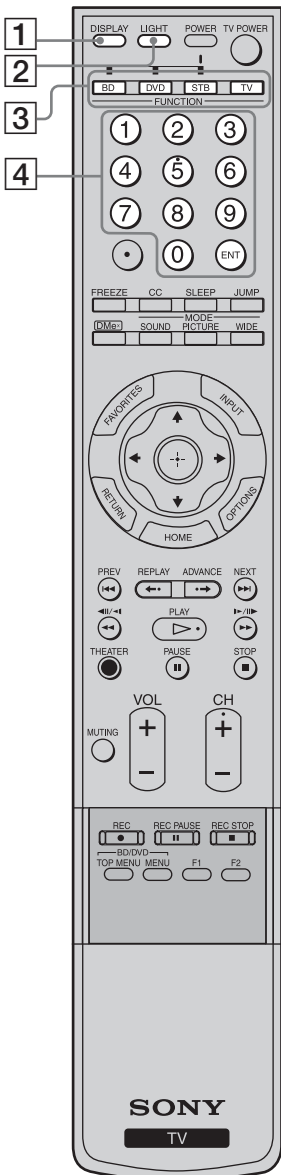

Buttons located at the right side of the TV will operate the same as these buttons on the remote control.

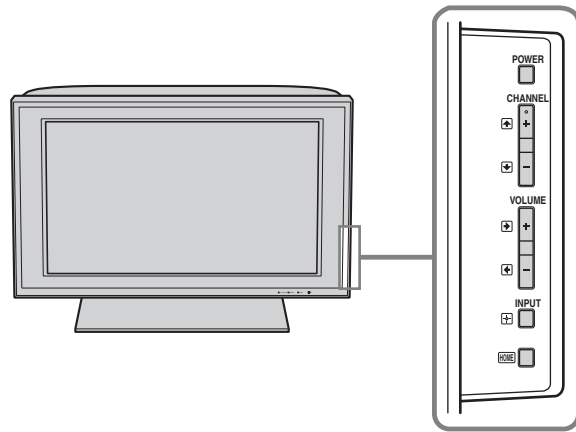

- The **5** button, **PLAY** and **CH +** have a tactile dot. Use them as a reference when operating the TV.

| Button | Description |
|----------------------------------|--|
| 1 DISPLAY | Press once to display the information pertaining to the channel and/or program when available. The OSD (On Screen Display) will time out in a few seconds or press again to immediately turn off the display. You can also set the display to show minimal information. See Info Banner on page 44. |
| 2 LIGHT | Press to illuminate the buttons on the remote control so that you can control them easily even if the room is dark. |
| 3 FUNCTION Buttons | The FUNCTION button indicator lights up momentarily when pressed to show which external equipment the remote control is operating. You must first press one of these FUNCTION buttons to operate the corresponding equipment. See page 26 for programming the remote control. |
| 4 0-9 ENT | Press 0-9 to select a channel; the channel changes after two seconds. Press ENT to change channels immediately. |

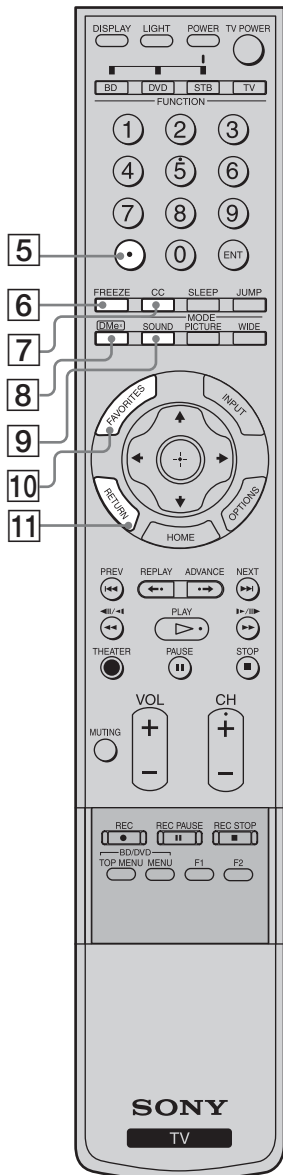

| Button | Description |
|--------------------------|--|
| 5 | Use with 0-9 and ENT to select digital channels. For example, to enter 2.1, press , , and ENT . |
| 6 FREEZE | Press once to display a frozen image with the current program in a window. Press again to return to the current program. <div style="text-align: center; margin-top: 10px;"> </div> <ul style="list-style-type: none"> • With the Freeze feature active, some features are unavailable. • While the Freeze feature is active, pressing HOME will deactivate Freeze and display the XMB™. |
| 7 CC | Press to turn on and off Closed Captions (CC) . To change or customize CC Display , see page 41. |
| 8 DMe^x | Press to access features in the optional BRAVIA external module. See your dealer or www.sony.com/bravia for more information. The module may not be available in your region. |
| 9 SOUND | Press to cycle through different sound settings: Dynamic for enhanced treble and bass, Standard for spoken dialog and Custom to customize the sound settings including the Sound Booster setting. |
| 10 FAVORITES | Press once to display the stored favorite channel list. You can store up to 30 channels in your Favorites list. <p>How to Add to Favorites</p> <p>While tuned to the channel you want to add to the list, press OPTIONS and highlight “Add to Favorites”, then press . A confirmation message of “Channel added to Favorites” will appear for a few seconds.</p> <p>How to Remove from Favorites</p> <p>While tuned to a channel that exists in the Favorites list, press OPTIONS and highlight “Remove from Favorites”, then press . A confirmation message of “Channel removed from Favorites” will appear for a few seconds.</p> <ul style="list-style-type: none"> Your Favorites list will be cleared each time you run Auto Program (see pages 19 and 40 for Auto Program). |
| 11 RETURN | Press to go back to the previous screen or exit from the screen when displaying menu items and settings. <ul style="list-style-type: none"> • While the P&P or PIP feature is active, pressing RETURN will exit from the screen (see page 31). |

(Continued)

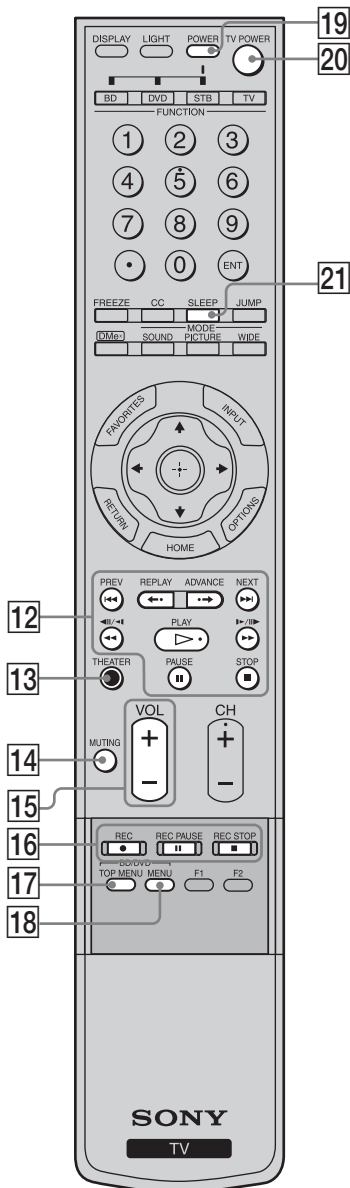

| Button | Description |
|---|---|
| 12 BD, DVD or STB Operating Buttons | When FUNCTION is switched on BD (Blu-ray Disc) , DVD or STB , these buttons operate the video equipment you have programmed into the remote control. For details, see “Using Other Equipment with Your Remote Control” on page 28. ◀◀ PREV : Press to replay the current program from the previous chapter mark (if any) or from the beginning of the live TV cache. ◀◀ REPLAY : Press to replay the current program for a set period of time. ▶▶ ADVANCE : Press to advance forward a set period of time when playing back a recorded program. ▶▶ NEXT : Press to advance forward to the next chapter mark (if any) or to live TV when playing back a recorded program. ◀◀ (fast reverse) : Press to play a program in fast rewind mode. ▷ PLAY : Press to play a program at a normal speed. ▶▶ (fast forward) : Press to play a program in fast forward mode. ⏸ PAUSE : Press to pause playback. ■ STOP : Press to stop the playback of a recorded program. |
| 13 THEATER | Press to turn on and off the Theater Mode. The picture settings will be set for a cinema like experience and the audio will be switched to the audio output of the attached speakers of your BRAVIA Theatre Sync audio system. Your BRAVIA Theatre Sync audio system must be connected by an HDMI connection to your TV (see page 17 for details). |
| 14 MUTING | Press to mute the sound. Press again or press VOL + to restore the sound. |
| 15 VOL +/- | Press to adjust the volume. |
| 16 DVR/VCR Record Buttons | <ul style="list-style-type: none"> ● REC: Press to record. Pressing this button alone starts the recording process. ⏸ REC PAUSE: Press to pause the recording. ■ REC STOP: Press to stop the recording. |
| 17 BD/DVD TOP MENU | Press to display the top menu of the BD/DVD disc. |
| 18 BD/DVD MENU | Press to display the BD/DVD disc menu.  <ul style="list-style-type: none"> • For further information, refer to the operating manual of the connected equipment. |
| 19 POWER | Press to turn on and off the external equipment selected from the FUNCTION buttons 3 . |
| 20 TV POWER | Press to turn on and off the TV. |
| 21 SLEEP | Press repeatedly until the TV displays the time in minutes (Off , 15min , 30min , 45min , 60min , 90min or 120min) that you want the TV to remain on before shutting off. To cancel Sleep Timer , press SLEEP repeatedly until Off appears. |



| Button | Description |
|----------------|--|
| 22 JUMP | Press to jump back and forth between two channels. The TV alternates between the current channel and the last channel that was selected. |



| | |
|----------------|--|
| 23 WIDE | Press repeatedly to step through the Wide Mode settings: Wide Zoom, Normal, Full, Zoom . The Wide Mode settings can be also accessed in the Screen settings (see page 37). |
|----------------|--|

Changing the Wide Screen Mode

(For PC timing, see below)

| 4:3 Original source Standard-definition source | 16:9 Original source High-definition source |
|---|--|
| | |
| ↓ | ↓ |
| Wide Zoom | Wide Zoom |
| Normal | Normal |
| Full | Full |
| Zoom | Zoom |

Changing the Wide Screen Mode for PC Timing

| Incoming PC signal 800 × 600 | Incoming PC signal 1280 × 768 |
|---------------------------------|----------------------------------|
| | |
| ↓ | ↓ |
| Normal | Normal |
| Full 1 | Full 1 |
| Full 2 | Full 2 |

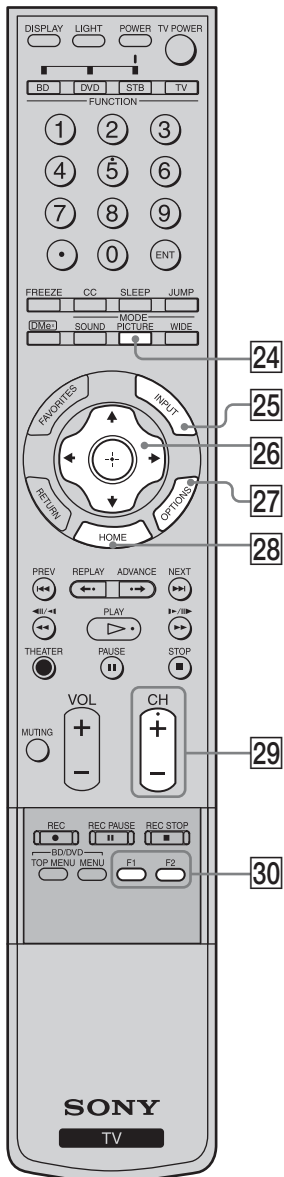

| Button | Description | | | | | | | | | | | | | | | | | | | | | | | | | | |
|--|--|-----------|----------------|---------|-------------|-------|-------------|------------|-------------|----------------------|-------------|-----------------|-------------|----------|-------------|------------|-------------|--|-------------|-----|-------------|-----------------|-------------|----------------|-------------|--------|-------------|
| 24 PICTURE | Press repeatedly to cycle through the available picture modes: Vivid, Standard, Cinema, Photo, Custom . (Available options depend on the current mode.) The picture modes can also be accessed in the Picture settings. For details, see Picture settings on page 34. | | | | | | | | | | | | | | | | | | | | | | | | | | |
| 25 INPUT | Press to display the list of External Inputs and TV mode. Press repeatedly to toggle through the inputs. <ul style="list-style-type: none"> Inputs can be changed by pressing ▲/▼ and + while the list of External Inputs is displayed. See page 44 on setting up the External Inputs labels, including the Skp feature. | | | | | | | | | | | | | | | | | | | | | | | | | | |
| 26 ▲/▼/◀/▶ + | Press ▲/▼/◀/▶ to move the on-screen cursor. Press + to select/confirm an item. | | | | | | | | | | | | | | | | | | | | | | | | | | |
| 27 OPTIONS | Press to display a list of convenient functions and menu shortcuts. The option menu items vary based on input and content. <table border="1" data-bbox="615 674 1229 1132"> <thead> <tr> <th>Menu Item</th> <th>Reference Page</th> </tr> </thead> <tbody> <tr> <td>Picture</td> <td>See page 34</td> </tr> <tr> <td>Sound</td> <td>See page 36</td> </tr> <tr> <td>P&P or PIP</td> <td>See page 31</td> </tr> <tr> <td>Exit P&P or Exit PIP</td> <td>See page 31</td> </tr> <tr> <td>Motion Enhancer</td> <td>See page 39</td> </tr> <tr> <td>Speakers</td> <td>See page 40</td> </tr> <tr> <td>Audio Swap</td> <td>See page 31</td> </tr> <tr> <td>Add to Favorites/ Remove from Favorites</td> <td>See page 21</td> </tr> <tr> <td>MTS</td> <td>See page 40</td> </tr> <tr> <td>Alternate Audio</td> <td>See page 40</td> </tr> <tr> <td>Digital Rating</td> <td>See page 42</td> </tr> <tr> <td>Screen</td> <td>See page 37</td> </tr> </tbody> </table> <ul style="list-style-type: none"> Motion Enhancer can only be set for the current input. Detailed information of digital rating will appear if Digital Rating is selected when an icon to inform you the digital rating information appears. | Menu Item | Reference Page | Picture | See page 34 | Sound | See page 36 | P&P or PIP | See page 31 | Exit P&P or Exit PIP | See page 31 | Motion Enhancer | See page 39 | Speakers | See page 40 | Audio Swap | See page 31 | Add to Favorites/ Remove from Favorites | See page 21 | MTS | See page 40 | Alternate Audio | See page 40 | Digital Rating | See page 42 | Screen | See page 37 |
| Menu Item | Reference Page | | | | | | | | | | | | | | | | | | | | | | | | | | |
| Picture | See page 34 | | | | | | | | | | | | | | | | | | | | | | | | | | |
| Sound | See page 36 | | | | | | | | | | | | | | | | | | | | | | | | | | |
| P&P or PIP | See page 31 | | | | | | | | | | | | | | | | | | | | | | | | | | |
| Exit P&P or Exit PIP | See page 31 | | | | | | | | | | | | | | | | | | | | | | | | | | |
| Motion Enhancer | See page 39 | | | | | | | | | | | | | | | | | | | | | | | | | | |
| Speakers | See page 40 | | | | | | | | | | | | | | | | | | | | | | | | | | |
| Audio Swap | See page 31 | | | | | | | | | | | | | | | | | | | | | | | | | | |
| Add to Favorites/ Remove from Favorites | See page 21 | | | | | | | | | | | | | | | | | | | | | | | | | | |
| MTS | See page 40 | | | | | | | | | | | | | | | | | | | | | | | | | | |
| Alternate Audio | See page 40 | | | | | | | | | | | | | | | | | | | | | | | | | | |
| Digital Rating | See page 42 | | | | | | | | | | | | | | | | | | | | | | | | | | |
| Screen | See page 37 | | | | | | | | | | | | | | | | | | | | | | | | | | |
| 28 HOME | Press to display the TV Home Menu/XMB™ to access the TV Home Menu items such as the TV Settings, TV channels and External Inputs list (see pages 9 and 32).  | | | | | | | | | | | | | | | | | | | | | | | | | | |
| 29 CH +/- | Press to scan through channels. To scan quickly through channels, press and hold down either +/- . | | | | | | | | | | | | | | | | | | | | | | | | | | |
| 30 F1/F2 | Press to select the function of connected components. For details, see “Using Other Equipment with Your Remote Control” on page 28. | | | | | | | | | | | | | | | | | | | | | | | | | | |

Indicators

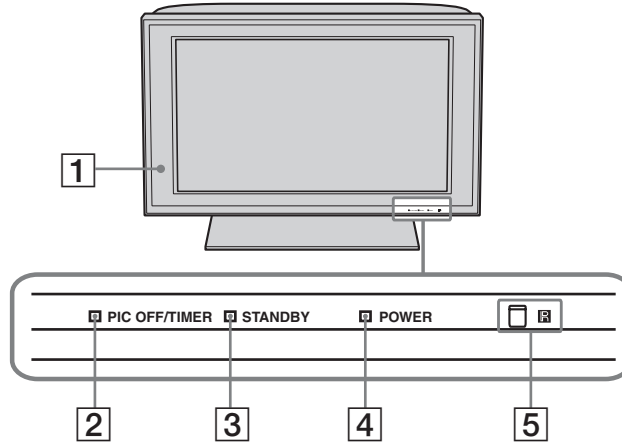

| Item | Description |
|--|---|
| 1 Speaker | Outputs the audio signal. |
| 2 PIC OFF/TIMER LED | Lights up in green when the Picture Off feature is activated. Lights up in orange when the timer is set. When the timer is set, this LED will remain lit even if the TV is turned off. For details, see page 34. |
| 3 STANDBY LED | Lights up in red when your TV is in PC standby mode. If the LED blinks in red continuously, this may indicate the TV needs servicing (see contacting Sony information on the back cover). |
| 4 POWER LED | Lights up in green when the TV is turned on. |
| 5 (IR) Infrared Receiver/Light Sensor | Receives IR signals from the remote control. Senses room light level and adjusts the screen brightness accordingly (see page 45 for details). Do not put anything near the sensor, as its function may be affected. |

Programming the Remote Control

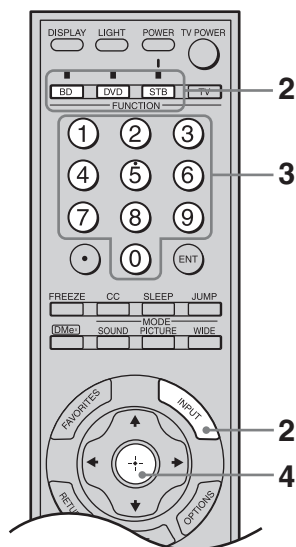

- 4 Press \oplus while the **FUNCTION** button is lit. If programmed correctly, the selected **FUNCTION** button blinks twice. If not it blinks five times.

To Confirm the Programming

If you can turn on and off the equipment by pressing the green **POWER** button, then the programming is complete. If not, try the next code listed.



- In some cases, you may not be able to program your remote control. If this is the case, use your equipment's own remote control.
- Any one of the **FUNCTION** buttons can be programmed to operate other equipment regardless of the labeling. For example, if programmed with the correct code, **DVD** can operate DVD/VCR combo equipment. This is useful if your equipment does not match the labeled buttons available. Make note of your equipment's programmed button.

Operating Sony Brand Video Equipment

The remote control is preset as below so that you do not need to program the remote control.

| Sony Equipment | Programmable Code Number |
|----------------|--------------------------------|
| BD | 101 (Sony Blu-ray Disc Player) |
| DVD | 751 (Sony DVD Player) |
| STB | 801 (Sony Satellite Receiver) |

Programming Non-Sony Video Equipment

Follow the steps below to program your TV's remote control.

- 1 In the space provided below, write down the three-digit code of your equipment found on the Manufacturer's Codes List on page 27.
If more than one code is listed, try entering the code listed first.
Code No. _____
- 2 Press and hold **BD**, **DVD** or **STB** and **INPUT** simultaneously to light the **FUNCTION** button.
- 3 Enter the three-digit code using \odot - \ominus while the selected button is lit. If the code is not entered within 10 seconds, you must repeat step 2.

Manufacturer's Codes

DVD Players

| Manufacturer | Code |
|--------------------------|----------|
| Sony | 751, 763 |
| General Electric/ RCA | 755 |
| Hitachi | 758 |
| JVC | 756 |
| Magnavox | 757 |
| Mitsubishi | 761 |
| Oritron | 759 |
| Panasonic | 753 |
| Philips | 757 |
| Pioneer | 752, 778 |
| RCA/PROSCAN | 755 |
| Samsung | 758 |
| Toshiba | 754 |
| Zenith | 760, 762 |

DVD/VCR Combo Units

| Manufacturer | Code |
|--------------|------|
| Sony | 767 |
| Broksonic | 776 |
| JVC | 775 |
| Panasonic | 777 |
| Samsung | 774 |
| Toshiba | 773 |
| Zenith | 768 |

HDD/DVD Combo Units

| Manufacturer | Code |
|--------------|---------------|
| Sony | 770, 771, 772 |

DVD Changers

| Manufacturer | Code |
|--------------|------|
| Sony | 765 |
| Panasonic | 766 |

DVR

| Manufacturer | Code |
|--------------|----------|
| Sony | 901 |
| DirecTV | 902, 903 |
| Samsung | 902, 903 |

Blu-ray Disc Player (BD)

| Manufacturer | Code |
|--------------|---------------|
| Sony | 101, 102, 103 |

5.1ch DVD AV System

| Manufacturer | Code |
|--------------|--------------------|
| Sony (DAV) | 601, 602, 603, 604 |

AV Receivers

| Manufacturer | Code |
|--------------|------|
| Sony | 764 |

VCRs

| Manufacturer | Code |
|----------------------|---|
| Sony | 301, 302, 303 (VHS, 8mm, Beta) |
| Sony DV | 348 |
| Admiral (M. Ward) | 327 |
| Aiwa* | 338, 344 |
| Audio Dynamic | 314, 337 |
| Broksonic | 317, 319 |
| Canon | 308, 309 |
| Citizen | 332 |
| Craig | 302, 332 |
| Curtis Mathes | 304, 309, 338 |
| Daewoo | 309, 312, 341 |
| DBX | 314, 336, 337 |
| Dimensia | 304 |
| Emerson | 316, 317, 318, 319, 320, 341 |
| Fisher | 330, 335 |
| Funai | 338 |
| General Electric | 304, 309, 329 |
| Go Video | 322, 339, 340 |
| Goldstar | 332 |
| Hitachi | 304, 305, 306, 338 |
| Instant Replay | 308, 309 |
| JC Penney | 304, 305, 309, 314, 330, 336, 337 |
| JVC | 314, 336, 337, 345, 346, 347 |
| Kenwood | 314, 332, 336, 337 |
| LG | 332 |
| LXI (SEARS) | 305, 330, 332, 335, 338 |
| Magnavox | 308, 309, 310 |
| Marantz | 314, 336, 337 |
| Marta | 332 |
| Memorex | 309, 335 |
| Minolta | 304, 305 |
| Mitsubishi/MGA | 323, 324, 325, 326 |
| Multitech | 321, 325, 338 |
| NEC | 314, 336, 337 |
| Olympic | 308, 309 |
| Optimus | 327 |
| Orion | 317 |
| Panasonic | 306, 307, 308, 309 |
| Pentax | 304, 305 |
| Philco | 308, 309 |
| Philips | 308, 309, 310 |
| Pioneer | 308 |
| Quasar | 306, 308, 309 |
| RCA/PROSCAN | 304, 305, 308, 309, 310, 311, 312, 313, 329 |
| Realistic | 309, 324, 328, 330, 335, 338 |
| Sansui | 314 |
| Samsung | 313, 321, 322 |
| Sanyo | 330, 335 |
| Scott | 312, 313, 321, 323, 324, 325, 326, 335 |
| Sharp | 327, 328 |

| Manufacturer | Code |
|-----------------------------|----------------------------|
| Signature 2000 (M. Ward) | 327, 338 |
| SV2000 | 338 |
| Sylvania | 308, 309, 310, 338 |
| Symphonic | 338 |
| Tashiro | 332 |
| Tatung | 314, 336, 337 |
| Teac | 314, 336, 337, 338 |
| Technics | 308, 309 |
| Toshiba | 311, 312 |
| Wards | 327, 328, 331, 332, 335 |
| Yamaha | 314, 330, 336, 337 |
| Zenith | 331 |

Cable Boxes

| Manufacturer | Code |
|--|--|
| Sony | 230 |
| Hamlin/Regal | 222, 223, 224, 225, 226 |
| Jerrold/ General Inst./ Motorola | 201, 202, 203, 204, 205, 206, 207, 208, 218, 222 |
| Oak | 227, 228, 229 |
| Panasonic | 219, 220, 221 |
| Pioneer | 211, 214, 215 |
| Scientific Atlanta | 209, 210, 211 |
| Tocom | 216, 217 |
| Zenith | 212, 213 |

Satellite Receivers

| Manufacturer | Code |
|------------------|--------------------|
| Sony | 801 |
| DirecTV | 902, 903 |
| Dish Network | 810 |
| Echostar | 810 |
| General Electric | 802 |
| Hitachi | 805 |
| Hughes | 804 |
| Humax | 902, 903 |
| JVC | 810 |
| LG | 902, 903 |
| Mitsubishi | 809 |
| Panasonic | 803 |
| Philips | 811, 902, 903 |
| RCA/PROSCAN | 802, 808, 902, 903 |
| Toshiba | 806, 807 |
| Samsung | 812, 902, 903 |

* If an Aiwa VCR does not work even though you enter the code for Aiwa, enter the code for Sony instead.

Using Other Equipment with Your Remote Control

Make sure that the equipment is programmed on the remote control (page 26).

Press **INPUT** repeatedly until you see the video input on the screen for your connected equipment. Remote control tips are provided below.





- Some functions cannot be operated depending on the equipment. In that case, operate by the remote control supplied with the equipment.



Cable Box





| To Do This ... | Press ... |
|--|-----------------------|
| Activate the remote control to operate the cable box | STB (FUNCTION) |
| Turn on/off | POWER |
| Select a channel | 0-9, ENT |
| Change channels | CH +/- |
| Back to previous channel | JUMP |

Satellite Receiver









| To Do This ... | Press ... |
|---|--|
| Activate the remote control to operate the satellite receiver | STB (FUNCTION) |
| Turn on/off | POWER |
| Select a channel | 0-9, ENT,  |
| Change channels | CH +/- |
| Back to previous channel | JUMP |
| Display channel number | DISPLAY |
| Display SAT Guide | OPTIONS |
| Display SAT Menu | HOME |
| Move highlight (cursor) |  |
| Select item |  |

VCR







| To Do This ... | Press ... |
|--|--|
| Activate the remote control to operate the VCR | STB (FUNCTION) |
| Turn on/off | POWER |
| INPUT SELECT | INPUT |
| Select a channel | 0-9, ENT |
| Change channels | CH +/- |
| Record |  |
| Play |  |

| To Do This ... | Press ... |
|-----------------|--|
| Stop |  |
| Fast forward |  |
| Rewind the tape |  |
| Pause |  (press again to resume normal playback) |

DVD Player or DVD Changer

| To Do This ... | Press ... |
|--|--|
| Activate the remote control to operate the DVD | DVD (FUNCTION) |
| Turn on/off | POWER |
| If you have a DVD changer, to skip disc | F1 |
| Play |  |
| Stop |  |
| Pause |  (press again to resume normal playback) |
| Step through different tracks of the disc |  to fast reverse or  to fast forward the disc when pressed during playback |
| Step through different chapters of the disc |  to step forward or  to step backward |
| Select a track directly | 0-9, ENT |
| Display the disc menu or top menu | BD/DVD MENU or TOP MENU |
| Operate the DVD menu | ,  |
| Display the system MENU | HOME |
| Return | RETURN |

Blu-ray Disc Player (BD)

| To Do This ... | Press ... |
|--|--|
| Activate the remote control to operate the Blu-ray Disc Player | BD (FUNCTION) |
| Turn on/off | POWER |
| Play |  |
| Stop |  |
| Pause |  (press again to resume normal playback) |
| Step through different tracks of the disc |  to fast reverse or  to fast forward the disc when pressed during playback |
| Display the POP UP menu (BD) | BD/DVD MENU |
| Display the disc menu (DVD) | BD/DVD MENU |
| Display the top menu (BD) | BD/DVD TOP MENU |
| Display the top menu (DVD) | BD/DVD TOP MENU |
| Operate the menu | ,  |
| MENU ON/OFF | HOME |

| To Do This ... | Press ... |
|------------------------------------|-----------|
| Specify the previous chapter/track | ⏮ |
| Specify the next chapter/track | ⏭ |
| Return to the previous display | RETURN |

5.1ch DVD AV System (Sony DAV)

| To Do This ... | Press ... |
|--|-------------------------|
| Activate the remote control to operate the DVD | DVD (FUNCTION) |
| Turn on/off | POWER |
| Select other equipment connected to the DAV | F1 |
| Disk skip | F2 |
| Display the disc menu or top menu | BD/DVD MENU or TOP MENU |
| Select a track directly | 0-9, ENT |
| Play | ▷ |
| Stop | ■ |
| Pause | ⏸ |
| Search the picture forward or backward | ⏭ or ⏮ during playback |
| Specify the previous chapter/track | ⏮ |
| Specify the next chapter/track | ⏭ |
| Move highlight (cursor) | ⬆ ⬇ ⬆ |
| Select item | ⊕ |
| Master volume | VOL +/-, MUTING |

DVD/VCR Combo Unit

| To Do This ... | Press ... |
|--|----------------------------------|
| Activate the remote control to operate the DVD/VCR | DVD (FUNCTION) |
| Turn on/off | POWER |
| Select the DVD | F 1 |
| Select the VCR | F 2 |
| Display the disc menu or top menu | BD/DVD MENU or TOP MENU |
| Play | ▷ |
| Stop | ■ |
| Pause | ⏸ |
| Search the picture forward or backward | ⏭ or ⏮ during playback |
| Move highlight (cursor) and select (DVD) | ⬆ ⬇ ⬆, ⊕ |
| Record (VCR) | ● |
| Change channels (VCR) | CH +/- or 0-9, ENT (using tuner) |
| Adjust tracking (VCR) | CH +/- (during tape playback) |
| Index search | ⏮ ⏭ |

| To Do This ... | Press ... |
|----------------|-----------|
| INPUT SELECT | INPUT |
| MENU ON/OFF | HOME |

HDD/DVD Combo Unit

| To Do This ... | Press ... |
|--|-------------------------|
| Activate the remote control to operate the DVD/HDD | DVD (FUNCTION) |
| Turn on/off | POWER |
| Select the HDD | F 1 |
| Select the DVD | F 2 |
| Play | ▷ |
| Stop | ■ |
| Pause | ⏸ |
| Search the picture forward or backward | ⏭ or ⏮ during playback |
| Move highlight (cursor) and select | ⬆ ⬇ ⬆, ⊕ |
| Record | ● |
| Record stop | ■ |
| Record pause | ⏸ |
| Specify the previous chapter/track | ⏮ |
| Specify the next chapter/track | ⏭ |
| Replay | ◀• |
| Advance | •▶ |
| Display the disc menu or top menu | BD/DVD MENU or TOP MENU |
| INPUT SELECT | INPUT |
| MENU ON/OFF | HOME |
| Search DVD by title or chapter | OPTIONS |
| Return to the previous display | RETURN |

AV Receiver

| To Do This ... | Press ... |
|--|-----------------|
| Activate the remote control to operate the AV Receiver | STB (FUNCTION) |
| Turn on/off | POWER |
| Master volume | VOL +/-, MUTING |
| Select other input connected to AV receiver | F1 |

DVR

| To Do This ... | Press ... |
|--|----------------|
| Activate the remote control to operate the DVR | DVD (FUNCTION) |
| Turn on/off | POWER |
| Play | ▷ |

(Continued)

| <i>To Do This ...</i> | <i>Press ...</i> |
|---|------------------|
| Replay the current program for a set period of time | ◀• |
| Advance forward a set period of time when playing back a recorded program | •▶ |
| Specify the previous chapter mark | ⏮ |
| Specify the next chapter mark | ⏭ |
| Stop | ■ |
| Pause | ⏸ |
| Record | ● |
| Open the Favorites List | FAVORITES |
| Open the Guide | OPTIONS |
| Open Main menu | HOME |
| Move highlight (cursor) | ⬆ ⬇ ⬅ ➡ |
| Select item | ⊕ |
| Close on-screen display | RETURN |
| Page +/- | CH+/- |
| Open the RECORDINGS List | TOP MENU |

Using P&P and PIP Features

This TV comes with the **P&P** and **PIP** features which allow you to view two pictures simultaneously. **P&P** (picture and picture) provides two windows side by side. **PIP** (picture in picture) provides PC input signal and TV channels.



- The VHF/UHF/CABLE input must be connected to use the **PIP** feature.
- For the **PIP** feature, **Closed Caption (CC)** is not available.

P&P



PIP



To Display the Sub Window

- 1 Press **OPTIONS** to display the **OPTIONS** menu while watching one of the following inputs: TV channels, Video, Component, HDMI or PC.
- 2 Press \uparrow/\downarrow to highlight **P&P** or **PIP**, and press \oplus to display the sub window.

| P&P Availability | |
|--|---|
| In main window | In sub window |
| Video 1/2/3 Component 1/2 HDMI IN 1/2/3 (except PC timing) | TV Channel (VHF/UHF/CABLE IN) Video 1/2/3 Component 1/2 |

| PIP Availability | |
|---------------------------------|-------------------------------|
| In main window | In sub window |
| PC HDMI IN 1/2/3 (PC timing) | TV Channel (VHF/UHF/CABLE IN) |



- To swap audio in **P&P** mode, use the \leftarrow/\rightarrow button to swap the highlight between the main window and sub window.
- To swap audio in **PIP** mode, press **OPTIONS**, then press \uparrow/\downarrow to highlight **Audio Swap**.
- 1080p signal cannot be displayed for Component 1/2 in the sub window in **P&P** mode.
- For compatible PC Timings, refer to the PC Input Reference Chart (see page 16).

To Change Inputs or Channels in the Window

Press \leftarrow/\rightarrow to highlight the window to change, and press **INPUT** to select the input to watch, or press **CH +/-** to change channels or enter the channel number using the **0-9** numeric buttons.



- You may also press **JUMP** to change channels.
- Inputs with **Skip** applied will not appear in the list of **External Inputs** (see page 44 for **External Inputs** settings).

To Change the Window Size of P&P

Press \leftarrow/\rightarrow to highlight the window, and press \uparrow/\downarrow to change the window size.

To Exit from P&P and PIP

- 1 Press **OPTIONS** to display the **OPTIONS** menu.
- 2 Press \uparrow/\downarrow to highlight **Exit P&P** or **Exit PIP** (depends on the mode you are in), and press \oplus to exit.



- You may also press **RETURN** while in these features to exit.
- Additional compatible device with television tuner is required to watch two simultaneous live television program.

Using the Menus

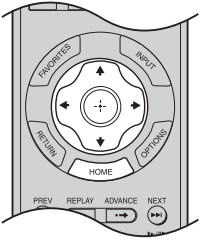

The **HOME** button allows you to access the **TV Home Menu** on the **XMB™** (Xross Media Bar) as well as a variety of TV features.

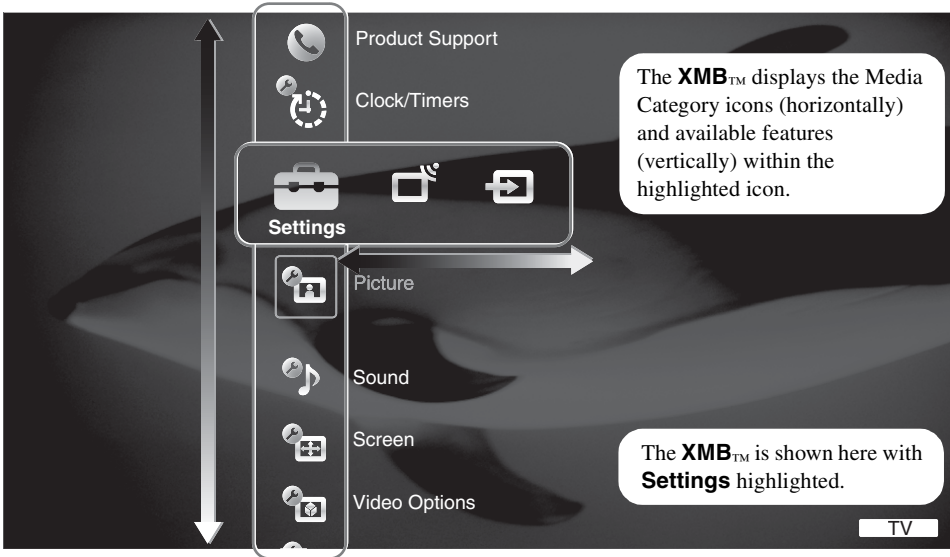

The **XMB™** displays the Media Category icons (horizontally) and available features (vertically) within the highlighted icon.

The **XMB™** is shown here with **Settings** highlighted.

Media Category Icons



Adjusting TV Settings

Customize the TV settings with various options.

Explanations of different **Settings** start from page 34.

- The available options vary depending on the situations and conditions applied. Unavailable options are grayed out or not displayed.



Watching TV

Select a channel.

- You can also select a TV channel using the number **0-9** or **CH +/-** buttons (see remote control section pages 20 and 24).



Accessing the Equipment Connected to Your TV

Watch a movie, play a game, record a program or work on your PC.

Assign a label using the **Label Inputs** feature for your convenience, see page 44.

Navigating through TV Home Menu on XMB™

1  Press **HOME** to display the **XMB™**.

2  Press **←/→** to select a Media Category icon.





Available TV settings and features are listed under the **Settings** icon.

Available channels are listed under the **TV** icon.

Select inputs from **Video1-3**, **Component 1-2**, **HDMI 1-3**, **PC** under the **External Inputs** icon.

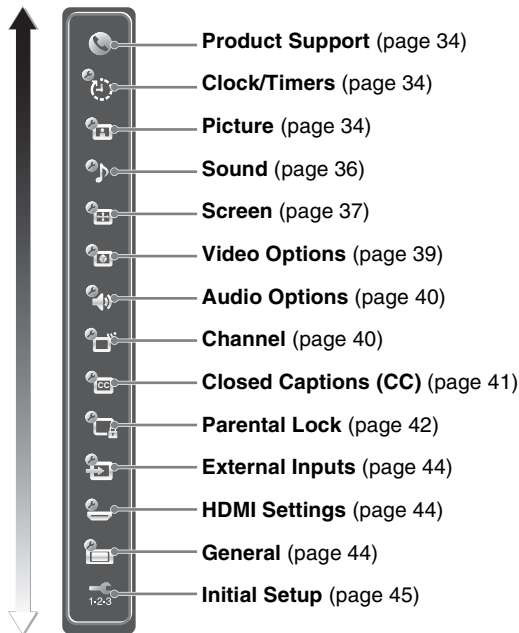
3  Press **↑/↓** to move within the Category Object Bar.
(The Category Object Bar shown below is for the **Settings**.)



4  Press **⊕** when desired item is highlighted.

5  Press **⊕** or **↑/↓** to select the highlighted item.

6  Press **RETURN** or **HOME** to exit.

TV Setting Description



Product Support

Contact Sony

Sony contact information is available from this screen for your convenience. Your TV's specific information such as Model Name, Serial Number, Software Version and downloadable ratings if available from the TV is displayed here.

Signal Diagnostics

Press to display the diagnostics information for the current signal.



Clock/Timers Settings

Current Time

Sets the current time (day, hour, minutes, and AM/PM). The **Timer** feature will not be available until you set **Current Time**.

- 1 Use the button to highlight the **Clock/Timers** icon and press .
- 2 Use the button to set the current time.
- 3 Press **RETURN** to display the confirmation screen.
- 4 Select **Yes** or **No** to save changes you made. Selecting **Yes** will save your settings and exit the **Current Time** setting screen.

Timer

Timer can be set, so the TV tunes to a certain channel as well as a specified volume at the specified time you set. After this is executed the TV will turn off at the specified time you set.

- 1 Use the button to highlight the **Timer** icon and press .
- 2 Press to select **On** to set the timer.
- 3 Use the button to set the following: **Day of the Week, Time, Duration, Channel, and TV On Volume**.
- 4 Press **RETURN** to display the confirmation screen.
- 5 Select **Yes** or **No** to save changes you made. Selecting **Yes** will save your settings and will light up the TIMER LED. Exit the **Timer** setting screen.

Sleep Timer

Sets the time in minutes (**Off, 15min, 30min, 45min, 60min, 90min, or 120min**) that you want the TV to remain on before shutting off automatically. Can also be set using the **SLEEP** button on the remote control (see page 22).



Picture Settings

Picture Mode

| | |
|-----------------|--|
| Vivid | For enhanced picture contrast and sharpness. |
| Standard | For standard picture settings. Recommended for home entertainment. |
| Cinema | For viewing film-based content. Most suitable for viewing in a theater-like environment. |
| Photo | For viewing still image content. |
| Custom | Allows you to store your preferred settings. |



- **Picture Mode** for all inputs can also be accessed by pressing **PICTURE** on the remote control to directly toggle the modes.
- The options for **Picture Mode** may differ depending on the **Video/Photo Optimizer** setting (see page 39).

| | | |
|---|--|--|
| Reset | Resets the current Picture Mode setting to the default values. | |
| Backlight | Brightens or darkens the backlight. | |
| Picture | Increases or decreases picture contrast. | |
| Brightness | Brightens or darkens the picture. | |
| Color | Increases or decreases color intensity. | |
| Hue | Increases or decreases the green tones. | |
| Color Temperature <i>White adjustment</i> | Cool | Gives the white colors a bluish tint. |
| | Neutral | Gives the white colors a neutral tint. |
| | Warm 1, 2 | Gives the white colors a reddish tint. |
| Sharpness | Sharpens or softens the picture. | |
| Noise Reduction | Reduces the noise level of connected equipment, and the VHF/UHF/CABLE input. | |
| MPEG Noise Reduction | Reduces the mosaic effect in MPEG-compressed video. Useful for DVDs and Digital TV channels. | |
| DRC Mode | Produces a high-resolution picture for high-density sources (e.g., Blu-ray Disc Player, DVD Player, satellite receiver). | |
| | Mode 1 | Recommended mode. |
| | Mode 2 | Only available for 1080i format. Mode 2 is especially effective when original standard-definition signals have been up-converted to 1080i format. |
| | Off | Turns off DRC Mode . |



- **DRC Mode** is available with all sources except for 1080p.
- **DRC Mode** is not available when **Game/Text Mode** is set to **On**.

| | |
|--------------------|--|
| DRC Palette | Allows you to customize the level of detail (Reality) and smoothness (Clarity). 1 Press the arrow buttons to highlight DRC Palette then press \oplus . The DRC Palette appears. |
|--------------------|--|

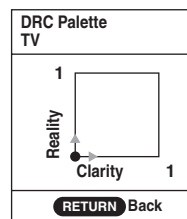

- 2** Press the arrow buttons to adjust the position of the marker (●). As you move the ● higher along the **Reality** axis, the picture becomes more detailed. As you move the ● to the right along the **Clarity** axis, the picture becomes smoother.



- **DRC Palette** is available with all sources except for 1080p.
- **DRC Palette** is not available when **Game/Text Mode** is set to **On**.

(Continued)

| | | |
|--------------------------|---|---|
| Advanced Settings | Reset | Resets all the advanced settings to the default values. |
| | Black Corrector | Enhances black areas of the picture for stronger contrast. |
| | Advanced C.E. (Advanced Contrast Enhancer) | Automatically optimizes the backlight and contrast. This setting is especially effective for dark picture scenes. It will increase the contrast distinction of the dark picture scenes. |
| | Gamma | Adjusts the balance between the light and dark areas of the picture. |
| | Clear White | Emphasizes white and light colors. |
| | Color Space | Selects the range of color reproduction from Wide or Standard . |
| | Live Color | Makes colors more vivid and reproduces clear skin tones. |
| | White Balance | Adjusts the color temperature color by color. |
| | Detail Enhancer | Enhances the details of the picture. |
| | Edge Enhancer | Enhances the outline of the picture. |



- **Picture** settings for all inputs can also be accessed by pressing **OPTIONS** on the remote control, then selecting **Picture** from the **OPTIONS** menu.
- **Picture** settings for PC Timings (HDMI or PC input) are the same as other input modes (see above for details), but **Noise Reduction**, **MPEG Noise Reduction**, **DRC Mode**, **DRC Palette** and **Detail Enhancer** are not available.

Sound Settings

Available **Sound** settings depend on the **Speakers** setting under **Audio Options** settings (page 40) or headphone connection.

| | | |
|-------------------|---|--|
| Sound Mode | Dynamic | Enhances treble and bass. |
| | Standard | Suitable for spoken dialog. |
| | Custom | Customizes the sound settings including the Sound Booster setting. |
| |  | |
| | | • Sound Mode can also be accessed by pressing OPTIONS on the remote control. |
| Reset | | Resets the current Sound Mode setting to the default values. |
| Treble | | Increases or decreases higher-pitched sounds. |
| Bass | | Increases or decreases lower-pitched sounds. |
| Balance | | Emphasizes left or right speaker balance. |
| Surround | S-FORCE Front Surround | Provides a virtual surround sound experience made possible using just two front speakers. |
| | Off | Select for normal stereo or mono reception. |
| | | |
| Voice Zoom | | Adjusts the clarity of human voices. For example, if the voice of a news announcer is indistinct, you can turn up this setting to make the voice clearer. Conversely, if you are watching a sports program, you can turn down this setting to soften the voice of the commentator. |



| | |
|----------------------|--|
| Sound Booster | Sound Booster provides a fuller sound with a greater sense of depth and width, by emphasizing the high and low frequency sounds. Select High or Low for the amount of boost you desire while in Custom of Sound Mode . Selecting Off will bypass the emphasis. |
| |  <ul style="list-style-type: none"> • Sound Booster is automatically set to High for Dynamic of Sound Mode and Low for Standard of Sound Mode. |
| Steady Sound | On Stabilizes the volume across all programs and commercials. Off Turns off Steady Sound . |
| Volume Offset | Adjusts the volume level of the current input (TV or video input) relative to other inputs. |





- **Sound** settings for PC Timings (HDMI or PC input) are same as all other input modes (see above for details).





Screen Settings

| | | |
|--|--|--|
| Wide Mode | Wide Zoom | Fills the screen with minimum distortion. |
| | Normal | Displays the 4:3 picture in its original aspect ratio when the original source is 4:3. |
| | Full | Enlarges the picture horizontally to fill the screen when the original source is 4:3 (Standard-definition source). When the original source is 16:9 (High-definition source), select this mode to display the 16:9 picture in its original size. |
| | Zoom | Enlarges the picture horizontally and vertically to fill the screen while maintaining the aspect ratio. |
| |  <ul style="list-style-type: none"> • Wide Mode can also be accessed by pressing WIDE on the remote control. • See WIDE button description on page 23 for accessing Wide Mode. | |
| Auto Wide | On | Automatically changes Wide Mode setting based upon content. If frequent screen changes are disturbing to you, select Off . |
| | Off | Turns off Auto Wide . Choose a screen mode from the Wide Mode option. |
| 4:3 Default <i>Select the default screen mode to use for 4:3 sources</i> | Wide Zoom | Enlarges the 4:3 picture to fill the 16:9 screen, displaying as much of the original image as possible. |
| | Normal | Displays the 4:3 picture in its original aspect ratio. |
| | Full | Enlarges the 4:3 picture horizontally only, to fill the screen. |
| | Zoom | Enlarges the picture horizontally and vertically to fill the screen while maintaining the aspect ratio. |
| | Off | Continues using the current Wide Mode setting when the channel or input is changed. |
| |  <ul style="list-style-type: none"> • 4:3 Default is not available when Auto Wide is set to Off. • If 4:3 Default is set to anything but Off, the Wide Mode setting applies only to the current channel. When you change channels (or inputs), Wide Mode is automatically replaced with the 4:3 Default setting for 4:3 sources. To retain the current Wide Mode setting as channels and inputs are changed, set 4:3 Default to Off. | |

(Continued)





| | | |
|------------------------|---|---|
| Display Area | Full Pixel | Displays the picture for 1080i or 1080p sources in its original size. |
| | +1 | Displays the original picture area. This setting can be selected for HDMI input video signals, except for 1080i or 1080p signals. |
| | Normal | Displays the recommended picture area. |
| | -1/-2 | Enlarges the picture to hide the edge of the picture. |
| Screen Position | Adjust the Vertical positioning by pressing ▲/▼ . Press ◀/▶ to adjust the Horizontal positioning. | |
| |  <ul style="list-style-type: none"> • The Screen Position feature is useful if the TV is connected to game equipment. | |
| Vertical Size | Adjusts the vertical size of the picture. Press ◀/▶ and press ⊕ to adjust. | |
| |  <ul style="list-style-type: none"> • Vertical Size is available only when Wide Mode is set to Wide Zoom or Zoom. | |

Screen settings for PC Timings (HDMI or PC input) differ from all other input modes and are shown below.

| | | |
|--------------------|---|---|
| Auto Adjust | Select Yes to start the auto adjust to display the PC input. | |
| Reset | Resets the current screen setting to the default values. | |
| Phase | Adjust after Pitch to fine tune overall sharpness. | |
| Pitch | Adjust uneven sharpness on screen. | |
| |  <ul style="list-style-type: none"> • For the PC input Signal Reference Chart, see page 16. | |
| H Center | Allows you to move the position of the picture horizontally (left and right). | |
| | To Adjust the H Center Press ▲/▼ to highlight H Center and press ⊕ . Press ◀/▶ to correct the centering then press ⊕ . | |
| V Center | Allows you to move the position of the picture vertically (up and down). | |
| | To Adjust the V Center Press ▲/▼ to highlight V Center and press ⊕ . Press ◀/▶ to correct the centering then press ⊕ . | |
| Wide Mode | Normal | Displays the picture in its original resolution and aspect ratio. |
| | Full 1 | Enlarges the picture to fill the screen, while maintaining its original aspect ratio. |
| | Full 2 | Enlarges the picture to fill the screen. |
| |  <ul style="list-style-type: none"> • Wide Mode can also be accessed by pressing WIDE on the remote control. • See WIDE button description on page 23 for accessing Wide Mode. | |



Video Options Settings

| | |
|--------------------------------------|---|
| Motion Enhancer | Activates Motionflow to enhance the smoothness of picture movement and to reduce blur. |
| | High Provides smoother picture movement such as for film-based content. |
| | Standard Provides smooth picture movement. Use this setting for standard use. |
| | Off Use this setting when the High and Standard settings result in noise. |
| |  <ul style="list-style-type: none"> Depending on the video, you may not see the effect visually, even if you have changed the setting. Motion Enhancer is not available when Game/Text Mode is set to On. |
| CineMotion | Select Auto 1 or Auto 2 to automatically detect film content and apply a reverse 3-2 pulldown process. Moving pictures will appear cleaner and more natural looking. Select Off to disable the detection. |
| Game/Text Mode | Provides the optimum screen for viewing images with fine lines and characters that are input from video game equipment and PCs. Set to On for the sharp display of fine lines or characters. |
| Video/Photo Optimizer | Provides suitable image quality by selecting the option depending on the input source (video or photograph data). |
| | Video-A Sets suitable image quality, depending on the input source, video data or photograph data when directly connecting Sony HDMI output-capable equipment that supports Video-A mode. |
| | Video Produces suitable image quality for moving pictures. |
| | Photo Produces suitable image quality for still images. |
| |  <ul style="list-style-type: none"> Setting is fixed to Video when the HDMI input signal is 1080/24p, or when Video-A mode is not supported on the connected equipment. |
| Video Color Space (x.v.Color) | Displays moving pictures that is more faithful to the original source by matching the color space of source. |
| |  <ul style="list-style-type: none"> Setting is fixed to Normal when the input signal is HDMI (RGB), even if x.v.Color is selected. |
| Photo Color Space | Selects the option to match the output color space within the output signal from the equipment connected to the HDMI or component input jacks. Select sYCC when using the equipment that supports x.v.Color. |
| |  <ul style="list-style-type: none"> Setting is fixed to sRGB when the input signal is HDMI (RGB), even if sYCC is selected. |
| Color Matrix | Allows you to reproduce the color-difference signals. It is recommended that you leave this at the factory default setting. |
| | Auto Automatically optimize based on signal. |
| | Custom If the tone of the picture from the input source is unnatural, select either ITU601 or ITU709 , which normalizes the tone. |
| |  <ul style="list-style-type: none"> When inputting VIDEO 1 to 3, ITU601 or ITU709 can be selected instead of Auto or Custom. |
| RGB Dynamic Range | Produces natural color by changing the luminance tone reproduction of HDMI input color signals (RGB). Set to Auto for standard use. Change the settings only when the luminance tone of the display is unnatural. |



Audio Options Settings



| | | |
|--|---|--|
| MTS <i>Enjoy stereo, bilingual and mono programs</i> | Stereo | For stereo reception when viewing a TV program broadcast in stereo. |
| | Auto SAP | Automatically switches the TV to second audio programs when a SAP signal is received. If no SAP signal is present, the TV remains in Stereo mode. |
| | Mono | For mono reception. Use to reduce noise during weak stereo broadcasts. |
| |  | <ul style="list-style-type: none"> • MTS is available only for analog programs. |
| Speakers | TV Speakers | Select to use the TV speakers for audio. |
| | Audio System | Select this option if you wish to use an external audio system for the TV sound. By selecting this option you are disabling the TV speakers. |
| Audio Out <i>Easy control of volume adjustment</i> | Fixed | Select to fix the audio output and allow you to adjust the volume with your audio system's remote control. (The TV's remote control's VOL and MUTING buttons have no effect on Audio Out .) |
| | Variable | Select to control the Audio Out 's volume and muting with your TV's remote control. |



- **Alternate Audio** is available only for digital programs. If the program you are watching is also available in other languages from the audio tracks, and if that language is what you have selected in the **Language** setting, your TV will automatically switch to the matching language with the **Alternate Audio** feature. The **Alternate Audio** option may be accessed by pressing **OPTIONS** on the remote control when alternate audio stream is available from the broadcaster.



Channel Settings

| | | |
|-----------------------------|--|---|
| Cable | On | For receiving cable channels via cable TV provider. |
| | Off | For using an antenna. |
| |  | <ul style="list-style-type: none"> • You should run Auto Program after changing the Cable setting. |
| Auto Program | Automatically sets up the channel list on the TV for all receivable channels. Channel scanning will be based on On/Off of Cable . | |
| | <ol style="list-style-type: none"> 1 Select Auto Program. 2 Select OK to start Auto Program. When Auto Program is completed, the screen will display the number of channels found. 3 Press RETURN to exit Auto Program. | |
| |  | <ul style="list-style-type: none"> • Running Auto Program will clear Favorites list. • If you run Auto Program again, previously scanned channels will be overwritten with the newly scanned channels. |
| Add Digital Channels | Select to add digital channels. Be sure to have the Cable option selected appropriately for the signal source. (Useful for antenna installation) | |

| | |
|----------------------------|--|
| Show/Hide Channels | <p>Allows you to show or hide channels when you surf with the CH +/- button or in the TV channel list on the XMB™.</p> <ol style="list-style-type: none"> 1 Press ▲/▼ to scroll through the channels until you highlight the channel to show or hide. 2 Press ⊕ to select Shown or Hidden. To show or hide more channels, repeat steps 1-2. <p> • Hidden channels can be accessed by entering the channel number with 0-9 buttons on the remote control.</p> |
| Edit Channel Labels | <p>Assigns labels (such as station call letters) to channel numbers.</p> <ol style="list-style-type: none"> 1 Press ▲/▼ to scroll through the channel numbers. Then press ⊕ to select the channel number to assign a label. 2 Press ▲/▼ to scroll through the label characters (A-Z, 0-9, etc.). Press ▶ to move to the next character. Repeat to add up to 7 characters to the label. Press ⊕ to set it. To assign labels to more channels, repeat steps 1-2. |



Closed Captions (CC) Settings

| | |
|-----------------------------------|--|
| CC Display | Allows you to turn On or Off the Closed Captions (CC) feature. |
| Analog CC | For the basic analog (EIA-608) closed caption options. |
| CC1, CC2, CC3, CC4 | Displays a printed version of the dialogue or sound effects of a program. (Should be set to CC1 for most programs.) |
| Text1, Text2, Text3, Text4 | Displays network/station information presented using either half or the whole screen (if available). |
| Digital CC | For both analog (EIA-608) and digital (EIA-708) closed caption options. Select from Service 1-6 and CC1-4 (advanced digital closed caption options). |
| Display Options | Customizes the Closed Captions (CC) displays with Text, Character Size, Character Style, Character Color, Character Opacity, Edge Type, Edge Color, Background Color and Background Opacity . |



- **Closed Captions (CC)** can be turned on and off directly by pressing **CC** on the remote control.



Parental Lock Settings

The **Parental Lock** feature allows you to block programs according to their content and rating levels and block channels (regardless of the programs). Password is necessary in setting up blocking.

To View Blocked Programs

Press **ENT** when tuned to a blocked program, then enter the password. To reactivate the **Parental Lock** settings, turn off and on the TV.

| | |
|-----------------|--|
| Password | Use 0-9 buttons on the remote control to enter a four-digit password. The first time the password is created, you must re-enter it again to confirm the password. "Password Set" message will appear on the screen upon confirmation. |
| | <p>Change Password</p> <p>You can change your password by entering the Parental Lock setting with the previously set password, highlight and select Change Password then enter the new password.</p> <p></p> <ul style="list-style-type: none"> You need your password for any future access into the Parental Lock settings. If you lose your password, see "Lost password" on page 48. |

| | |
|----------------|---|
| Country | Select the country name of U.S.A. or Canada for the appropriate ratings. The rating system varies between these two countries. See Custom Rating System Chart on page 43. |
|----------------|---|

| | | |
|---------------|--------------------|---|
| Rating | Off | Turns off Parental Lock . No programs are blocked from viewing based on their ratings. |
| | Child | Maximum ratings permitted are: U.S.: TV-Y, TV-G, G Canada: C, G, TV-Y |
| | Youth | Maximum ratings permitted are: U.S.: TV-PG, PG Canada: C8+, PG, 8 ans+, TV-PG |
| | Young Adult | Maximum ratings permitted are: U.S.: TV-14, PG-13 Canada: 14+, 13 ans+, TV-14 |
| | Custom | Sets ratings manually. U.S.: See page 43 for details. Canada: See page 43 for details. |



- If you are not familiar with the parental guideline rating system, you should select **Child**, **Youth**, or **Young Adult** to help simplify the rating selection. To set more specific ratings, select **Custom**.

| | | |
|---|---|--|
| Digital Rating <i>(Available only in U.S.A. where advanced ratings exist)</i> | Off | Turns off Digital Rating . No programs containing digital ratings are blocked from viewing. |
| | Clear All | Clears the downloaded ratings. |
| | Custom | Customizes Parental Lock with downloadable digital ratings. |
| Unrated <i>(Available only when Country is set to U.S.A.)</i> | Allow | Allows programs and movies that are broadcast without a rating. |
| | Block | Blocks all programs and movies that are broadcast without a rating. |
| |  | <ul style="list-style-type: none"> If you block unrated TV programs, be aware that the following types of programs may be blocked: programs broadcast from another country, emergency broadcasts, political programs, sports, news, public service announcements, religious programs and weather. |

| | |
|----------------------|--|
| Channel Block | Allows you to block channels regardless of program ratings. The password needs to be set up prior to blocking channels. The blocked channel can only be viewed by entering the correct password. |
| | To View a Blocked Channel |
| | Press ENT when tuned to the blocked channel then enter the password. |

Custom Rating System Chart

For **Country** selection of **U.S.A.**:

| | | | |
|--|---|--|--|
| Movie Rating | G | All children and general audience | |
| | PG | Parental guidance suggested | |
| | PG-13 | Parental guidance for children under 13 | |
| | R | Restricted viewing, parental guidance is suggested for ages under 17 | |
| | NC-17 and X | No one 17 or under allowed | |
| TV Rating <i>Block programs by their rating, content or both</i> | Age-Based Ratings | | |
| | TV-Y | All children | |
| | TV-Y7 | Directed to children age 7 and older | |
| | TV-G | General audience | |
| | TV-PG | Parental guidance suggested | |
| | TV-14 | Parents strongly cautioned | |
| | TV-MA | Mature audience only | |
| | Content-Based Ratings | | |
| | FV | Fantasy violence | |
| | D | Suggestive dialogue | |
| | L | Strong language | |
| | S | Sexual situations | |
| | V | Violence | |
| |  | • To ensure maximum blocking capability, set the Age-Based Ratings. | |

For **Country** selection of **Canada**:

| | | |
|-----------------------|---|------------------------------------|
| English Rating | C | All children |
| | C8+ | Children 8 years and older |
| | G | General programming |
| | PG | Parental guidance |
| | 14+ | Viewers 14 and older |
| | 18+ | Adult programming |
| French Rating | G | General programming |
| | 8 ans+ | Not recommended for young children |
| | 13 ans+ | Not recommended for ages under 13 |
| | 16 ans+ | Not recommended for ages under 16 |
| 18 ans+ | Programming restricted to adults | |
| U.S.A. Rating | See TV Rating under U.S.A. for details. | |



External Inputs Settings

| | |
|---------------------|--|
| Label Inputs | <p>You can label your inputs with the name of equipment you have connected. To assign your own label or Skip the input:</p> <ol style="list-style-type: none"> 1 Press ▲/▼ to highlight the video input (Video 1-3, Component 1-2 and HDMI 1-3, PC), then press ⊕ to select the desired input. 2 Press ▲/▼ to highlight the display label you want to assign, then press ⊕. <p></p> <ul style="list-style-type: none"> • You can select from the following labels for each input. Video 1-3, Component 1-2 and HDMI 1-3: - , DVD, Cable Box, Satellite, BD, VCR, Receiver, DVR, Game, Camcorder, PC, Skip. PC: - , Skip. • “-” indicates that no labels are assigned. |
|---------------------|--|



HDMI Settings



HDMI inputs of this TV will recognize and communicate with other Sony equipment equipped with HDMI Control.

| | |
|------------------------------|--|
| HDMI Control | On/Off feature allows your TV to communicate with other equipment that supports HDMI Control. |
| Device Auto Power Off | Select On to have your connected HDMI Control equipment to power off automatically when the TV is turned off. Select Off to disable this function. |
| TV Auto Power On | Select On to control your TV's power on from your connected HDMI Control equipment. Select Off to disable this function. |
| Device List | Displays a list of HDMI Control equipment connected to the TV. |



General Settings

| | |
|---------------------|--|
| Language | Select the language of your choice from English, Español and Français to be used for displaying all the on-screen settings. |
| Info Banner | <p>Displays the program name and the program information such as program title and program rating (if available from the broadcaster) when option is set to On. Select Off for minimal display information. Selecting Off will not completely disable the banner display. Info Banner also appears on the screen each time the channel is changed or DISPLAY on the remote control is pressed.</p> <p></p> <ul style="list-style-type: none"> • To see the rating information on the banner, Info Banner setting must be set to On. |
| Power Saving | Reduces the power consumption by adjusting the backlight brightness. This also enhances the black level. Select from Off, Low, High and Picture Off . |

| | |
|----------------------------|--|
| Light Sensor | <p>Enables the automatic picture (screen) brightness control. Light Sensor measures the room brightness which allows the TV to automatically adjust the backlight brightness based on the picture settings and the ambient room light conditions.</p>  <ul style="list-style-type: none"> • Be sure not to put anything around the sensor, as its function may be affected (see page 25). • In low light the range of the backlight control is reduced when Light Sensor is set to On. |
| PC Power Management | <p>On Automatically enters to standby mode when there is no signal input for more than 30 seconds. The STANDBY LED on the front panel will illuminate when PC Power Management switches the TV to standby mode.</p> <hr/> <p>Off Turns off PC Power Management.</p>  <ul style="list-style-type: none"> • To bring the TV out of standby mode and recover TV features, press TV POWER on the remote control. • PC Power Management is not VESA-compliant. |
| Logo Illumination | <p>Select to illuminate the Sony logo on the front panel of the TV. Select On or Off.</p> |

Initial Setup

1·2·3 If you have missed the **Initial Setup** when you first connected the TV or if you want to scan all receivable channels, you can run the **Initial Setup**. Follow the instructions on the screen. Settings such as picture and sound adjustments will not be affected by this **Initial Setup**.



- **Favorites** list will be cleared each time you run the **Initial Setup**.

Other Information

Cleaning

Clean the ventilation holes of this TV set regularly (once a month). If dust accumulates, the cooling fan may not operate properly.

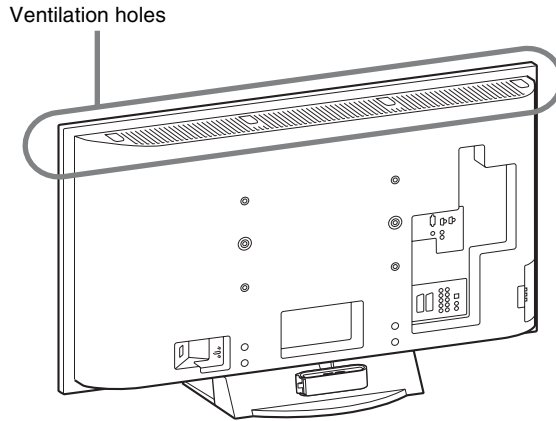

Troubleshooting

If you have questions, service needs, or require technical assistance related to the use of your Sony TV, please visit our website or call one of the following numbers:

<http://www.sony.com/tvsupport>

1-800-222-SONY(7669) for US Support

1-877-899-SONY(7669) for Canadian Support

| Condition | Explanation/Solution |
|------------------------------------|--|
| No picture | |
| No picture | <ul style="list-style-type: none">• Check the Power Saving settings (see page 44). |
| Cannot receive any channels | <ul style="list-style-type: none">• Make sure the power cord is connected securely.• Turn on the power of the TV.• Check antenna/cable connections.• Make sure the Cable setting is correct for your TV signal source. |
| TV is locked to one channel | <ul style="list-style-type: none">• Perform Auto Program to add receivable channels that are not present in the TV's memory (see pages 19 and 40). |
| Cannot receive or select channels | <ul style="list-style-type: none">• Perform Auto Program to add receivable channels that are not present in the TV's memory (see pages 19 and 40).• To receive or select cable channels, make sure that Cable in the Channel settings is set to On (see page 40). To receive or select UHF channels over an antenna, make sure Cable is set to Off. |
| The TV turns off automatically | <ul style="list-style-type: none">• Check if Sleep Timer is activated, or confirm the Duration setting of Timer (see page 34).• Check PC Power Management in the General Settings (see page 45). |
| No picture from some video sources | <ul style="list-style-type: none">• Check the connection between the optional video equipment and the TV.• Press INPUT on the remote control (see page 24).• Press HOME on the remote control. Select your desired input from the External Inputs list. |

| Condition | Explanation/Solution |
|--|---|
| Poor picture | |
| The quality of the images is not as good as what I saw at the store | <ul style="list-style-type: none"> Picture quality depends on the signal content. See Quick Setup Guide (supplied) to display the best possible picture for that signal. |
| Double images or ghosts | <ul style="list-style-type: none"> Check antenna/cable connections. Check the antenna location and direction. |
| Only snow and noise appear on the screen | <ul style="list-style-type: none"> Check if the antenna is broken or bent. Check if the antenna has reached the end of its serviceable life. (3-5 years in normal use, 1-2 years at the seaside.) |
| Dotted lines or stripes | <ul style="list-style-type: none"> Keep the TV away from noise sources such as cars, motorcycles, or hair-dryers. If using the 300-ohm twin lead, move the excess lead away from the TV or try using the 75-ohm coaxial cable (not supplied) instead. |
| No color/Dark picture/Color is not correct/The picture is too bright | <ul style="list-style-type: none"> Press PICTURE to select the desired Picture Mode (see page 24). Adjust the Picture Mode options in the Picture settings (see page 34). If you set Power Saving to Low or High, it will enhance the black level (see page 44). |
| Noisy picture | <ul style="list-style-type: none"> Make sure that the antenna is connected using the 75-ohm coaxial cable (not supplied). Keep the antenna cable away from other connecting cords. To avoid TV interference, make sure to use an undamaged antenna cable. |
| No sound/Noisy sound | |
| Good picture, no sound | <ul style="list-style-type: none"> Check the volume control. Press MUTING or VOL + so that “Muting” disappears from the screen (see page 22). Disconnect your headphones. Set Speakers to TV Speakers in the Audio Options settings (see page 40). If it is set to Audio System, sound is not output from the TV’s speakers regardless of the TV’s volume control. When using HDMI input with Super Audio CD or DVD-Audio, DIGITAL OUT (Optical) may not provide an audio signal. |
| Audio noise | <ul style="list-style-type: none"> Make sure that the antenna is connected using the 75-ohm coaxial cable (not supplied). Keep the antenna cable away from other connecting cords. To avoid TV interference, make sure to use an undamaged antenna cable. |
| There is a whirring sound | <ul style="list-style-type: none"> This is the sound of internal fans of the TV (except for KDL-52XBR4/XBR5). It is not a malfunction. |
| PC Input | |
| No Picture / No Signal | <ul style="list-style-type: none"> Confirm the PC is correctly connected to the TV with either the PC IN (with HD15-HD15 cable with ferrite core (not supplied)) or with the HDMI IN. Ensure the output signal from the PC is one of the formats listed on page 16. Turn the PC off. Confirm the PC connection and restart the PC. Plug and play will auto-detect the TV and correctly set up PC timing. Verify PC Power Management is activated (see page 45). |
| Poor Picture | <ul style="list-style-type: none"> Adjust the resolution (see page 16). Adjust Pitch and Phase. |
| General | |
| Wide Mode changes automatically | <ul style="list-style-type: none"> The current Wide Mode setting is automatically replaced with the 4:3 Default setting when you change the channel or video input, if 4:3 Default in the Screen settings is set to other than Off. If you want to lock in Wide Mode selected with the WIDE button on the remote control, set 4:3 Default to Off in the Screen settings (see page 37). Check Auto Wide in the Screen settings (see page 37). |

(Continued)

| Condition | Explanation/Solution |
|---|--|
| Suddenly the picture gets smaller | <ul style="list-style-type: none"> The picture gets smaller during the commercials, this is due to the method the provider broadcasts their contents. When HD content channels switch to SD definition content (commercials), the picture may be small with a black border. |
| “Black box” on screen | <ul style="list-style-type: none"> You have selected a text option and no text is available (see page 41). To turn off this feature, set CC Display to Off. If you were trying to select closed captioning, select CC1 instead of Text1-4. |
| Black bands appear at the edges of the screen | <ul style="list-style-type: none"> Some wide screen programs are filmed in aspect ratios that are greater than 16:9 (this is especially common with theatrical releases). Your TV will show these programs with black bands at the top and bottom of the screen. For more details, check the documentation that came with your DVD (or contact your program provider). Programs in 4:3 aspect ratio will have bands on left and right sides of the screen. |
| Certain programs on DVD or other digital sources display a loss of detail, especially during fast-motion or dark scenes | <ul style="list-style-type: none"> This is due to the digital compression of the source content used by certain digital broadcasts and DVDs which may cause your TV’s screen to display less detail than usual, or cause artifacts (small blocks or dots, pixelations) to appear on your screen. These signal compressions are more visible and are dependent on the clarity and resolution of the television. |
| When playing a video game, there is delay between the remote control and the actual video | <ul style="list-style-type: none"> Set the Game/Text Mode to ON (see page 39). |
| Remote control does not operate | <ul style="list-style-type: none"> Check the polarity of the batteries or replace the batteries. Point the remote control at the remote control sensor located at the front of the TV. Fluorescent lamps can interfere with your remote control operation; try turning off the fluorescent lamps. Keep the remote control sensor area clear from obstacles. |
| Cannot change channels with the remote control | <ul style="list-style-type: none"> If you are using the TV to change channels, first press TV (FUNCTION) once, and the TV indicator lights up. If you are using another device to change channels, be sure you have not inadvertently switched your TV from the channel 3 or 4 setting. If you are using another device to change channels, be sure to press FUNCTION for that device. For example, if you are using your cable box to change channels, be sure to press STB (FUNCTION) once, and the STB indicator lights up. |
| Remote control does not operate non-Sony video equipment | <ul style="list-style-type: none"> If you replaced the batteries to the remote control recently, the code numbers for the video equipment may need to be reset. There may be more than one code for the equipment that you are attempting to operate. There is a possibility that some non-Sony equipment cannot be operated by your Sony TV remote control. You may need to use the equipment’s original remote control. |
| Some digital cable channels are not being displayed | <ul style="list-style-type: none"> Certain cable companies have limitations on the broadcast of digital cable channels. Check with your cable company for more information. The digital cable channel may be set to Hidden in the Show/Hide Channels setting (see page 41). |
| Lost password | <ul style="list-style-type: none"> Select the Password settings on the Parental Lock settings, then enter the following master password: 4357. The master password clears your previous password and allows you to enter a new password (see page 42). |
| How to reset the TV to factory settings | <ul style="list-style-type: none"> Turn on the TV. While holding down ▲ on the remote control, press POWER on the TV. (The TV will turn itself off, then back on again.) Release ▲. WARNING: The Reset will clear all of your customized settings including the Parental Lock setting. |

Specifications

| Model | KDL-40XBR4/XBR5 | KDL-46XBR4/XBR5 | KDL-52XBR4/XBR5 |
|--|---|---|---|
| System | | | |
| Television system | NTSC: American TV standard / ATSC (8VSB terrestrial): ATSC compliant 8VSB QAM on cable; ANSI/SCTE 07 2000 (Does not include CableCARD functionality) | | |
| Channel coverage | Analog terrestrial: 2-69 / Digital terrestrial: 2-69 Analog Cable: 1-125 / Digital Cable: 1-135 | | |
| Panel system | LCD (Liquid Crystal Display) Panel | | |
| Speaker output | 11 W + 11 W | | |
| Input/Output jacks | | | |
| Antenna | 75-ohm external terminal for VHF/UHF | | |
| VIDEO IN 1/2/3 | S VIDEO (4-pin mini DIN)(VIDEO 1 only): Y: 1.0 Vp-p, 75 ohms unbalanced, sync negative / C: 0.286 Vp-p (Burst signal), 75 ohms VIDEO: 1 Vp-p, 75 ohms unbalanced, sync negative AUDIO: 500 mVrms (100% modulation)/ Impedance: 47 kilohms | | |
| COMPONENT IN 1/2 | YPBPR (Component Video): Y: 1.0 Vp-p, 75 ohms unbalanced, sync negative / PB: 0.7 Vp-p, 75 ohms / PR: 0.7 Vp-p, 75 ohms / Signal format: 480i, 480p, 720p, 1080i, 1080p AUDIO: 500 mVrms (100% modulation)/ Impedance: 47 kilohms | | |
| HDMI IN 1/2/3 | HDMI: Video: 480i, 480p, 720p, 1080i, 1080p, 1080/24p / Audio: Two channel linear PCM 32, 44.1 and 48 kHz, 16, 20 and 24bits, Dolby Digital AUDIO (HDMI IN 1 only): 500 mVrms (100% modulation)/ Impedance: 47 kilohms | | |
| AUDIO OUT | 500 mVrms (100% modulation) (Fixed) / 1 Vrms at the maximum volume setting (Variable) | | |
| DIGITAL OUT (OPTICAL) | Optical Digital Audio Output (PCM/Dolby digital) | | |
| PC IN | D-sub 15-pin, analog RGB, 0.7 Vp-p, 75 ohms, positive See the PC Input Signal Reference Chart on page 16. | | |
| PC AUDIO INPUT | Stereo mini jack, 500 mVrms, 1 kilohm | | |
| Headphones | Stereo mini jack / Impedance: ≥ 16 ohms | | |
| REMOTE | RS232C, D-sub 9-pin (KDL-40XBR5/46XBR5/52XBR5 only) | | |
| Power and others | | | |
| Power requirement | 120 V-240 V AC, 50/60 Hz | | |
| Power consumption | | | |
| in use | 235 W | 280 W | 320 W |
| in standby | All models less than 0.4 W | | |
| Screen size (inches measured diagonally) | 40 | 46 | 52 |
| Display resolution (horizontal × vertical) | 1,920 dots × 1,080 lines | | |
| Speaker | Full range: 40 × 100 mm (1 3/8 × 4 inches) (4) Tweeter: 40 mm (1 5/8 inches) (2) | Full range: 50 × 105 mm (2 × 4 1/4 inches) (4) Tweeter: 40 mm (1 5/8 inches) (2) | |
| Dimensions (W × H × D) | | | |
| with stand (mm) | 1111 × 717 × 322 | 1262 × 795 × 322 | 1415 × 890 × 384 |
| (inches) | 43 3/4 × 28 1/4 × 12 3/4 | 49 3/4 × 31 3/8 × 12 3/4 | 55 3/4 × 35 1/8 × 15 1/8 |
| without stand (mm) | KDL-40XBR4 1111 × 657 × 121 43 3/4 × 25 7/8 × 4 7/8 | KDL-46XBR4 1262 × 734 × 121 49 3/4 × 29 × 4 7/8 | KDL-52XBR4 1415 × 827 × 123 55 3/4 × 32 5/8 × 4 7/8 |
| (inches) | KDL-40XBR5 1111 × 657 × 123 43 3/4 × 25 7/8 × 4 7/8 | KD-46XBR5 1262 × 734 × 123 49 3/4 × 29 × 4 7/8 | KDL-52XBR5 1415 × 827 × 125 55 3/4 × 32 5/8 × 5 |
| wall-mount hole pattern (mm) | 300 × 200 | 300 × 200 | 400 × 300 |
| Mass | | | |
| with stand | 31.0 kg 69 lb. | 38.0 kg 84 lb. | 49.0 kg 108 lb. |
| without stand | 26.0 kg 58 lb. | 33.0 kg 73 lb. | 42.0 kg 93 lb. |

(Continued)

| Model | KDL-40XBR4/XBR5 | KDL-46XBR4/XBR5 | KDL-52XBR4/XBR5 |
|----------------------|--|-----------------|-----------------|
| Supplied accessories | Remote control RM-YD017 (1) / Size AA batteries (2) / AC power cord (1) / Support belt (1) / Securing screw (1) / Wood screw (1) / Cable holder (1 attached to the TV) / Operating Instructions (1) / Quick Setup Guide (1) / Installing the Wall-Mount Bracket (1) / Warranty Card (1) / Online Registration Card (U.S.A. and Canada only) (1) | | |
| Optional accessories | Headphones plug adapter / Connecting cables / Wall-Mount Bracket: SU-WL500 (KDL-40XBR4/KDL-40XBR5/KDL-46XBR4/KDL-46XBR5/KDL-52XBR4/KDL-52XBR5) / TV-Stand: RHT-G800 (KDL-40XBR4/KDL-40XBR5/KDL-46XBR4/KDL-46XBR5/KDL-52XBR4/KDL-52XBR5), SU-FL300M (KDL-40XBR4/KDL-40XBR5/KDL-46XBR4/KDL-46XBR5), SU-FL300L (KDL-46XBR4/KDL-46XBR5/KDL-52XBR4/KDL-52XBR5) / Colour Variation Unit: CRU-40X1 (KDL-40XBR4), CRU-46X1 (KDL-46XBR4), CRU-52X1 (KDL-52XBR4) | | |



- Optional accessories availability depends on its stock.
- Design and specifications are subject to change without notice.

Index

0-9 buttons 20
4:3 Default 37

A

AC IN 13
Add Digital Channels 40
Advanced Settings 36
Analog CC 41
Audio Out 40
AUDIO OUT jack 13
Auto Adjust 38
Auto Program 19, 40
Auto Wide 37

B

Backlight 35
Balance 36
Bass 36
BD, DVD or STB Operating Buttons 22
BD/DVD MENU button 22
BD/DVD TOP MENU button 22
Brightness 35

C

Cable 40
Cable holder 18
CC button 21
CC Display 41
CH +/- button 24
Channel Block 43
CineMotion 39
Color 35
Color Matrix 39
Color Temperature 35
COMPONENT IN jack (1080p/1080i/
720p/480p/480i) 13
Connecting the TV 14
Contact Sony 34
Country 42
Current Time 34

D

Device Auto Power Off 44
Device List 44
Digital CC 41
DIGITAL OUT (OPTICAL) jack 13
Digital Rating 42
Display Area 38
DISPLAY button 20
Display Options 41
DMe^x button 21
DMe^x/SERVICE 13
DRC Mode 35
DRC Palette 35
DVR/VCR Record Buttons 22

E

Edit Channel Labels 41
English Rating 43
ENT button 20

F

F1/F2 button 24
FAVORITES button 21
FREEZE button 21
French Rating 43
FUNCTION buttons 20

G

Game/Text Mode 39

H

H Center 38
HDMI Control 18, 44
HDMI IN jack 11, 13
Headphone jack 11
HOME button 24
Hue 35

I

Info Banner 44
Infrared Receiver (IR)/Light Sensor 25
INPUT button 24
Installing the TV on a wall 10

J

JUMP button 23

L

Label Inputs 44
Language 44
LIGHT button 20
Light Sensor 45
Logo Illumination 45

M

Motion Enhancer 39
Movie Rating 43
MPEG Noise Reduction 35
MTS 40
MUTING button 22

N

Noise Reduction 35

O

OPTIONS button 24

P

P&P 31
Password 42
PC IN jack 12
PC Power Management 45
Phase 38
Photo Color Space 39
PIC OFF/TIMER LED 25
Picture 35
PICTURE button 24
Picture Mode 34
PIP 31
Pitch 38
POWER button 22

POWER LED 25
Power Saving 44

R

Rating 42
REMOTE 13
Remote control
 programming 26–27
Reset 35, 36, 38, 48
RETURN button 21
RGB Dynamic Range 39

S

S VIDEO jack 13
Screen Position 38
Setting up channels 19
Settings
 Audio Options 40
 Channel 40
 Clock/Timers 34
 Closed Captions (CC) 41
 External Inputs 44
 General 44
 HDMI Settings 44
 Initial Setup 45
 Parental Lock 42
 Picture 34
 Product Support 34
 Screen 37
 Sound 36
 Video Options 39
Sharpness 35
Show/Hide Channels 41
Signal Diagnostics 34
SLEEP button 22
Sleep Timer 34
Sound Booster 37
SOUND button 21
Sound Mode 36
Speaker 25
Speakers 40
STANDBY LED 25
Steady Sound 37
Surround 36

T

THEATER button 22
Timer 34
Treble 36
Troubleshooting 46–48
TV Auto Power On 44
TV POWER button 22
TV Rating 43

U

U.S.A. Rating 43

Unrated 42

Using with remote control

5.1ch DVD AV System 29

AV Receiver 29

Blu-ray Disc Player 28

Cable Box 28

DVD Player or DVD Changer 28

DVD/VCR Combo Unit 29

DVR 29

HDD/DVD Combo Unit 29

Satellite Receiver 28

VCR 28

V

V Center 38

Vertical Size 38

VHF/UHF/CABLE input 13

Video Color Space (x.v.Color) 39

VIDEO/AUDIO (L/R) jacks 11, 13

Video/Photo Optimizer 39

Voice Zoom 36

VOL +/- button 22

Volume Offset 37

W

WIDE button 23

Wide Mode 37, 38

X

XMB™ 9, 32

For Your Convenience

Please contact Sony directly if you:

- Have questions on the use of your television after reading your Operating Instruction manual and Quick Setup Guide
- Experience difficulty operating your television

Contact Sony Customer Support at:

<http://www.sony.com/tvsupport>

or to speak with a support representative:

United States

1-800-222-SONY (7669)

Canada

1-877-899-SONY (7669)

Sony will work to resolve your questions more quickly than your retailer or place of purchase.

Please Do Not Return the Product to the Store

