

LCD Digital Color TV

Setup Guide (Operating Instructions)

Getting Started

Using Your BRAVIA TV

Network Setup

Additional Information

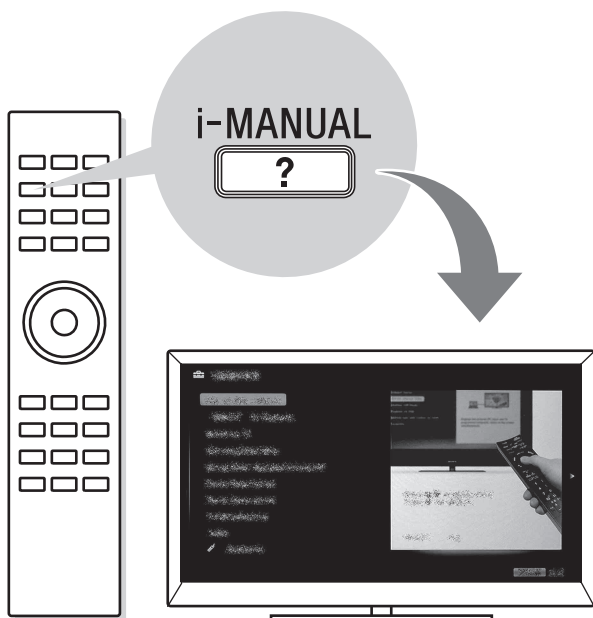

BRAVIA

Sony Customer Support

U.S.A.: www.sony.com/tvsupport

Canada: www.sony.ca/support

United States

1.800.222.SONY

Canada

1.877.899.SONY

Please Do Not Return
the Product to the Store

Owner's Record

The model and serial numbers are located at the side and rear of the TV. Record these numbers in the spaces provided below. Refer to them whenever you call upon your Sony dealer regarding this TV.

Model Name

Serial No.

CAUTION

To prevent electric shock and blade exposure, do not use this polarized AC plug with an extension cord, receptacle or other outlet unless the blades can be fully inserted.

- Some people may experience discomfort (such as eye strain, fatigue, or nausea) while watching 3D video images or playing stereoscopic 3D games. Sony recommends that all viewers take regular breaks while watching 3D video images or playing stereoscopic 3D games. The length and frequency of necessary breaks will vary from person to person. You must decide what works best. If you experience any discomfort, you should stop watching the 3D video images or playing stereoscopic 3D games until the discomfort ends; consult a doctor if you believe necessary. You should also review (i) the instruction manual of any other device or media used with this television and (ii) our website (www.sony.com/tvsupport) for the latest information. The vision of young children (especially those under six years old) is still under development. Consult your doctor (such as a pediatrician or eye doctor) before allowing young children to watch 3D video images or play stereoscopic 3D games. Adults should supervise young children to ensure they follow the recommendations listed above.
- When using the simulated 3D function, please note that the displayed image is modified from the original due to the conversion done by this television.
- Operate the TV only on 110-240 V AC (U.S.A./Canada 120 V AC)

Licensing Information

Macintosh is a trademark of Apple Inc., registered in the U.S. and other countries.

HDMI, the HDMI Logo, and High-Definition Multimedia Interface are trademarks or registered trademarks of HDMI Licensing LLC in the United States and other countries.

Ferguson Patent Properties, LLC:
U.S. Patent No. 5,717,422
U.S. Patent No. 6,816,141

Manufactured under license from Dolby Laboratories. Dolby and the double-D symbol are trademarks of Dolby Laboratories.

Rovi and Rovi On Screen Guide are trademarks of Rovi Corporation and/or its subsidiaries.

The Rovi On Screen Guide system is manufactured under license from Rovi Corporation and/or its subsidiaries.

The Rovi On Screen Guide system is protected by one or more United States patents of Rovi Corporation and/or its subsidiaries.

Rovi Corporation and/or its subsidiaries and related affiliates are not in any way liable for the accuracy or availability of the program schedule information or other data in the Rovi On Screen Guide system and cannot guarantee service availability in your area. In no event shall Rovi Corporation and/or its related affiliates be liable for any damages in connection with the accuracy or availability of the program schedule information or other data in the Rovi On Screen Guide system.

Blu-ray Disc is a trademark.

“BRAVIA” and BRAVIA, S-Force, Motionflow, BRAVIA Sync, and  are trademarks or registered marks of Sony Corporation.

“PlayStation” is a registered trademark and “PS3” is a trademark of Sony Computer Entertainment Inc.

DLNA[®], the DLNA Logo and DLNA CERTIFIED[®] are trademarks, service marks, or certification marks of the Digital Living Network Alliance.

“FACE DETECTION” logo is trademark of Sony Corporation.

TrackID is a trademark or registered trademark of Sony Ericsson Mobile Communications AB.

Music and video recognition technology and related data are provided by Gracenote[®]. Gracenote is the industry standard in music recognition technology and related content delivery. For more information, please visit www.gracenote.com.

CD, DVD, Blu-ray Disc, and music and video-related data from Gracenote, Inc., copyright © 2000-present Gracenote. Gracenote Software, copyright © 2000-present Gracenote. One or more patents owned by Gracenote apply to this product and service. See the Gracenote website for a nonexhaustive list of applicable Gracenote patents. Gracenote, CDDB, MusicID, MediaVOCs, the Gracenote logo and logotype, and the “Powered by Gracenote” logo are either registered trademarks or trademarks of Gracenote in the United States and/or other countries.

Opera[®] Browser from Opera Software ASA. Copyright 1995-2010 Opera Software ASA. All rights reserved.





Your BRAVIA TV is ENERGY STAR® qualified in the “Home” mode.

It meets strict energy efficiency guidelines set by the U.S.

Environmental Protection Agency and Department of Energy. ENERGY STAR is a joint program of these government agencies, designed to promote energy efficient products and practices.

Changes to certain features, settings, and functionalities of this TV (i.e. Rovi On Screen Guide, Picture/Sound, Light Sensor, Power Savings) can increase or change the power consumption.

Depending upon such changed settings, the power consumption may exceed the limits required for the ENERGY STAR qualification in the “Home” mode.

The 55 class has a 54.6 inch viewable image size (measured diagonally).



- Features may differ depending on the model/region/area.
- The illustrations of the remote control used in this manual are of the RM-YD059 unless otherwise stated.
- The illustrations used in this manual may differ depending on your TV model.
- Retain this manual for future reference.

The BRAVIA® Full HDTV Experience

Thank you for choosing Sony! Your new BRAVIA® TV opens the door to the “Full HDTV Experience.” This document will help you get the most out of your TV.

Please take a moment to register your TV at:
U.S.A.: <http://productregistration.sony.com>
Canada: <http://www.SonyStyle.ca/registration>

Four Steps to a Full HD Experience

Set, Source, Sound, and Setup.

1 Set

Now that you have made the best selection in LCD TV technology, be sure to remove all accessory contents from the packaging before setting up your TV.

2 Source

To experience the stunning detail of your BRAVIA TV, you need access to HD programming.

- Upgrade your signal or content source to high-definition (HD) by contacting your HD service provider.

This TV displays all video input signals in a resolution of 1,920 dots × 1,080 lines.

- Receive over-the-air HD broadcasts with an HD-quality antenna connected directly to the back of your TV.
Visit www.antennaweb.org for more information on antenna selection and setup.
- Discover the wealth of entertainment now available on super-high resolution Blu-ray Disc™ player and other Sony HD equipment.

3 Sound

Complete the high-definition experience with a BRAVIA Sync™ surround sound system or A/V receiver from Sony.





4 Setup

Install your TV and connect your sources. See page 12 for sample connection diagrams. To help assure the highest quality for your HD experience, use Sony HDMI (High-Definition Multimedia Interface) cables.

To learn more about HDTV, visit:

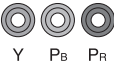
U.S.A.: <http://www.sony.com/HDTV>
Canada: <http://www.SonyStyle.ca/hd>

The following chart shows the high-definition (HD) and standard-definition (SD) video formats supported by your BRAVIA TV inputs.

	INPUT	VIDEO	AUDIO	SUPPORTED FORMATS							
				1080/24p/30p	1080p	1080i	720/24p/30p	720p	480p	480i	PC*
HD	HDMI		When HDMI is connected to DVI with an adapter, a separate Audio L/R is necessary.	✓	✓	✓	✓	✓	✓	✓	✓
	COMPONENT	 Y Pb Pr	 Audio L/R		✓	✓		✓	✓	✓	
SD	VIDEO	 Composite video connection	 Audio L/R							✓	

* For supported PC formats refer to the i-Manual.

Table of Contents

Getting Started

Checking the accessories	8
Inserting batteries into the remote control.....	8
Before setting up your TV	9
1: Attaching the Table-Top Stand	10
2: Adjusting the viewing angle of the TV	11
3: Connecting the TV	12
4: Securing the TV	15
5: Bundling the cables.....	16
6: Running initial setup.....	16
Using a Wall-Mount Bracket.....	17
Installing the TV Against a Wall or Enclosed Area.....	18

Using Your BRAVIA TV

Watching the TV.....	20
Selecting various functions and settings (Home Menu)	22
Displaying Operating Instructions (i-Manual)	24
Programming the Remote Control (For RM-YD057 and RM-YD067 remote control users)	26

Network Setup

Preparing a wired network	27
Preparing a wireless LAN.....	27
Setting up the Internet connection	28
If you cannot connect to the Internet.....	29
Adjusting the server display settings.....	30

Additional Information

Troubleshooting	31
Specifications	33

After setting up your BRAVIA TV and learning basic operations with this manual, see the built-in manual (i-Manual) for further explanation of the features of your TV.

This TV has a built-in manual (i-Manual). To access the i-Manual, press **i-MANUAL** on the remote control, and select an item. For details, see page 24 of this manual. Contents of the i-Manual may differ depending on the model/region/area.

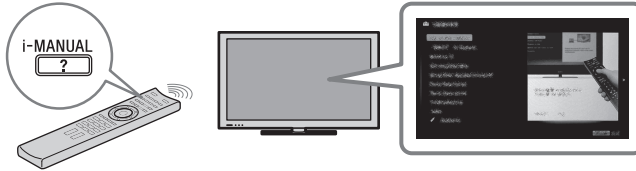

Contents of the i-Manual

How to Use i-Manual

“BRAVIA” TV Features

- 3D Feature
- Intelligent Presence Sensor
- “BRAVIA” Internet Video
- “BRAVIA” Internet Widgets
- Wireless LAN
- “BRAVIA” Sync with “Control for HDMI”
- TrackID™/Music Search/Video Search

Watching TV

- 3D Feature
- Rovi On Screen Guide™
- Favorites
- Wide Mode
- Picture Mode
- Photos/Music/Videos
- Twin Picture (PIP)
- Twin Picture (P&P)

Settings/Home Menu

- About the Home Menu
- Settings
- Picture & Display
- Sound
- Preferences
- i-Manual
- Channels & Inputs
- Network
- Product Support

Using Other Equipment/Internet

- VCR/DVD Player
- Audio System
- USB Device (e.g. Digital Camera)
- Picture Frame
- HDMI Equipment
- Internet/Wireless LAN
- Home Network
- PC
- Programming the Remote Control

Parts Description

- Remote Control
- TV Controls and Indicators
- Terminals

Troubleshooting

Index

✎ Bookmarks

Getting Started

Checking the accessories

Remote control (1)^{*1}

Size AAA batteries (2)

Table-Top Stand (1)^{*2}

Fixing screws for Table-Top Stand (M5 × 16) (3) (except KDL-60NX720)

Assembling screws for Table-Top Stand (M6 × 14) (4)

Hexagon wrench (1)

Video/Component Adapter (1)

Operating Instructions (this manual)

and other documents

^{*1} Please refer to the model name printed on the remote control.

^{*2} Assembling the Table-Top Stand is required. Refer to the supplied Table-Top Stand leaflet to assemble the Table-Top Stand.

Inserting batteries into the remote control

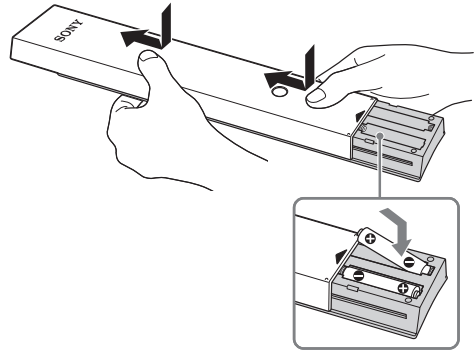

1 Remove the protection sheet.

2 Push and slide the cover upward.

Guidelines for Remote Control

- Point your remote control directly at the IR sensor located on your TV.
- Make sure that no objects are blocking the path between the remote control and the IR sensor on your TV.

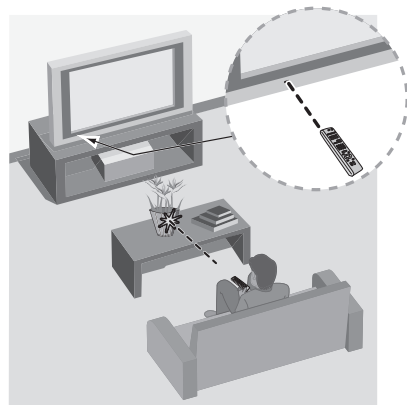

- Fluorescent lamps can interfere with your remote control; try turning off the fluorescent lamps.

- If you are having problems with the remote control, reinsert or replace your batteries and make sure that they are correctly inserted.

Before setting up your TV

Some TV models are packaged with a detached Table-Top Stand so you can mount your TV to a wall right away. If you are not mounting the TV to a wall, you will need to attach the Table-Top Stand. You will need a Phillips screwdriver (not supplied) and maybe also a hexagon wrench (supplied with some models) and the supplied screws to complete the task. Look for the supplied Table-Top Stand instruction leaflet.

Be sure to consider the following while setting up your TV:

- Disconnect all cables when carrying the TV.
- Carry the TV with the adequate number of people; larger size TVs require two or more people.
- Correct hand placement while carrying the TV is very important for safety and to avoid damage.

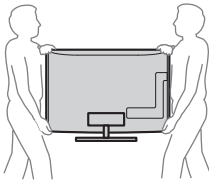

- Ensure your TV has adequate ventilation, see page 18.
- For best picture quality, do not expose the screen to direct illumination or sunlight.
- Avoid installing the TV in a room with reflective wall and floor materials.

- Avoid moving the TV from a cold area to a warm area. Sudden room temperature changes may cause moisture condensation. This may cause the TV to show poor picture and/or poor color. Should this occur, allow moisture to evaporate completely before powering the TV on.
- Ensure that there are no objects in front of the TV.
- Do not expose the Intelligent Presence Sensor to direct sunlight or other strong light, as malfunction may occur.

IR Sensor

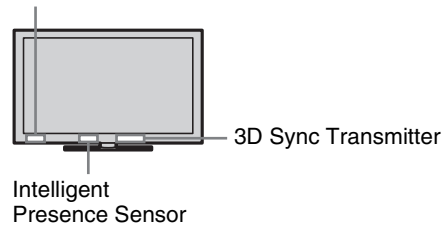

1: Attaching the Table-Top Stand

Refer to the supplied Table-Top Stand instruction leaflet for proper attachment.



- Do not put stress on the LCD panel or the frame around the screen.
- Be careful to not pinch your hands or the AC power cord when you install the TV unit to the Table-Top Stand.

For XBR-55/46HX929, KDL-55/46HX820 and KDL-55/46NX720

- 1 Place the TV unit on the Table-Top Stand.

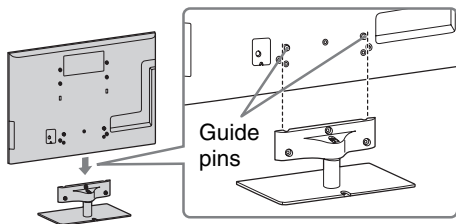

- Align the TV from the top, slide it in until the guide pins cannot be seen.

- 2 Use the supplied screws to attach the TV unit to the Table-Top Stand.

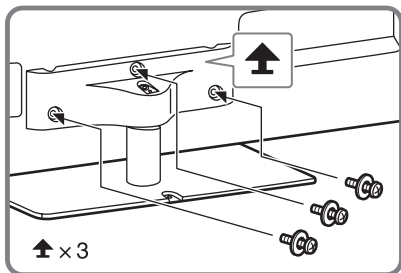

- If you use an electric screwdriver, set the torque at approximately 1.5 N·m {15 kgf·cm}.

For KDL-60NX720

- 1 Align with the two dowels of the Table-Top Stand, and gently place the TV, checking that the Δ mark is facing the front.

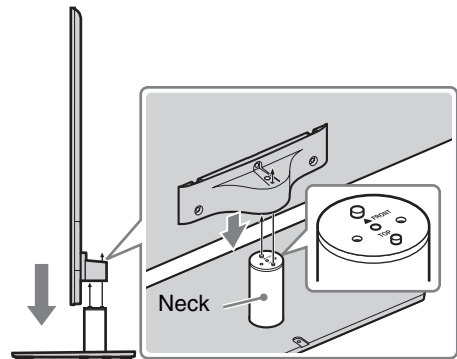

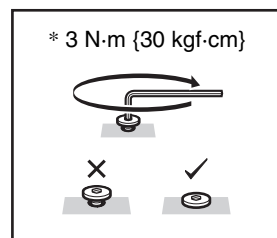
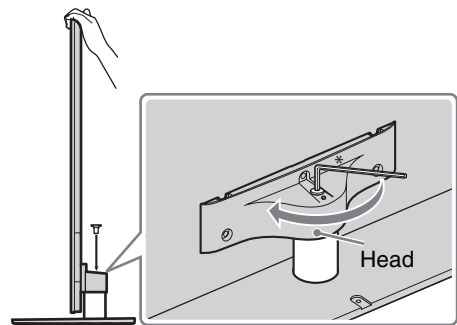

- 2 Attach the TV and Table-Top Stand with the supplied screw and hexagon wrench.



- Tighten to approximately 3 N·m {30 kgf·cm}.

Detaching the Table-Top Stand from the TV

To detach the Table-Top Stand from the TV, remove the screws  fixed in step 2. For KDL-60NX720, be sure to remove the screws  for detaching the head when the Table-Top Stand is not attached to the TV.



- Do not remove the Table-Top Stand for any reason other than to install corresponding accessories on the TV.
- When removing the Table-Top Stand from the TV, lay the display face down on a stable work surface that is larger than the TV.
- To prevent damaging the surface of the LCD display, make sure to place a soft cloth on the work surface.
- When installing the TV on a wall, remove the screws from the rear of the TV. The screws and number of screws depends on the TV model. (They are fastened in the screw holes for wall mounting.) Be sure to store the removed screws in a safe place, keeping them away from children.
- When attaching the Table-Top Stand again, be sure to fasten the screws (previously removed) to the original holes on the rear of the TV.

2: Adjusting the viewing angle of the TV

This TV can be adjusted within the angles as illustrated.

Angle adjustment (Swivel) (except KDL-60NX720)



- When adjusting the angle, hold the stand with one hand to avoid having the stand slip or TV tip over.

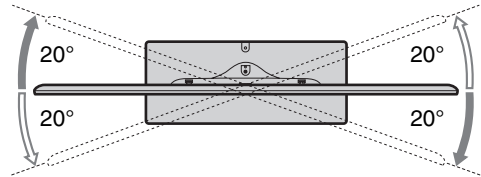

Angle adjustment (Tilt) (except KDL-60NX720)

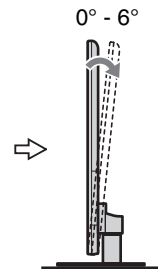
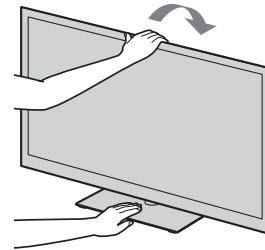

3: Connecting the TV



- Use an antenna cable connector no greater than 14 mm thick.
- Use an HDMI cable connector within 12 mm (thickness) × 21 mm (width).

Shown with a Set Top Box with HDMI connection

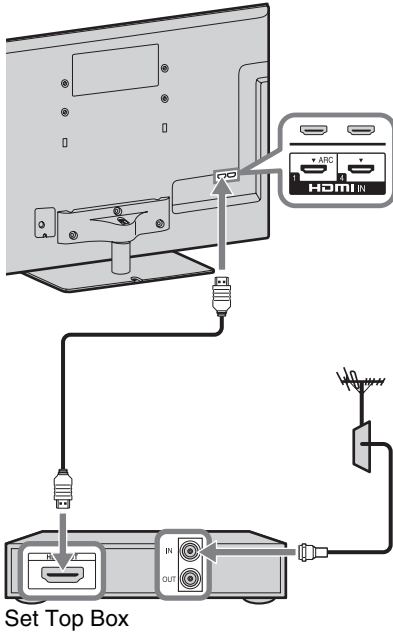

Recommendation of the F type plug

The one based on the following drawing is recommended about the F type plug. Projection of the inner wire from the connection part must be less than 1.5 mm.

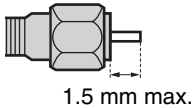

(Reference drawing of the F type plug)

Shown with a Set Top Box with COMPONENT connection

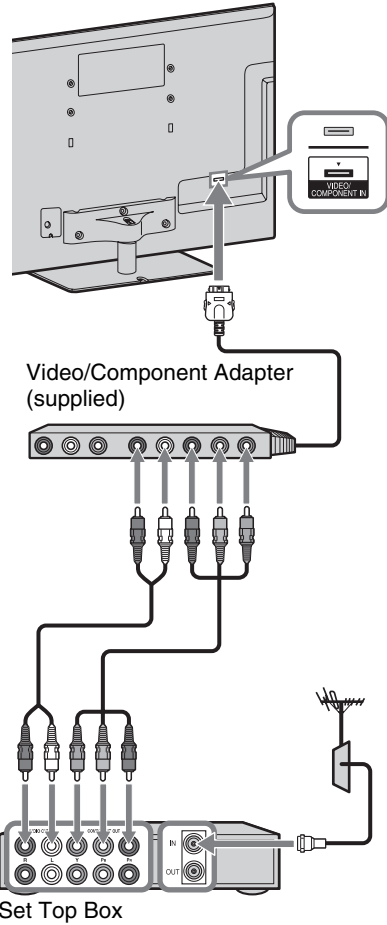

Cable System or VHF/UHF Antenna System

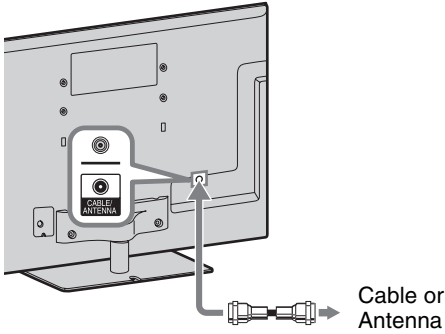

Shown with HD BRAVIA® Sync™ Basic Connection

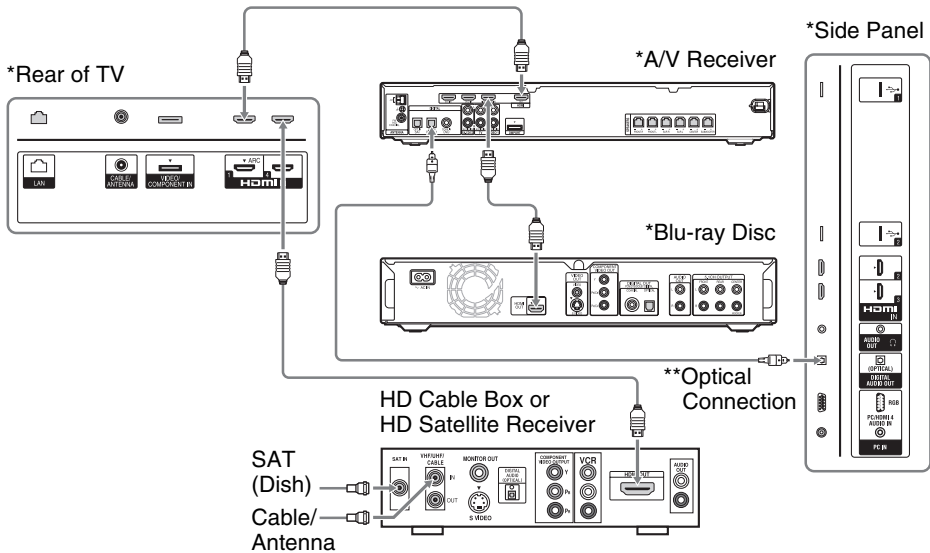

* Signifies a BRAVIA Sync capable device.

** The optical connection is only needed for A/V receivers that do not support ARC (Audio Return Channel).

Shown with HD Basic Connection with Home Theater System

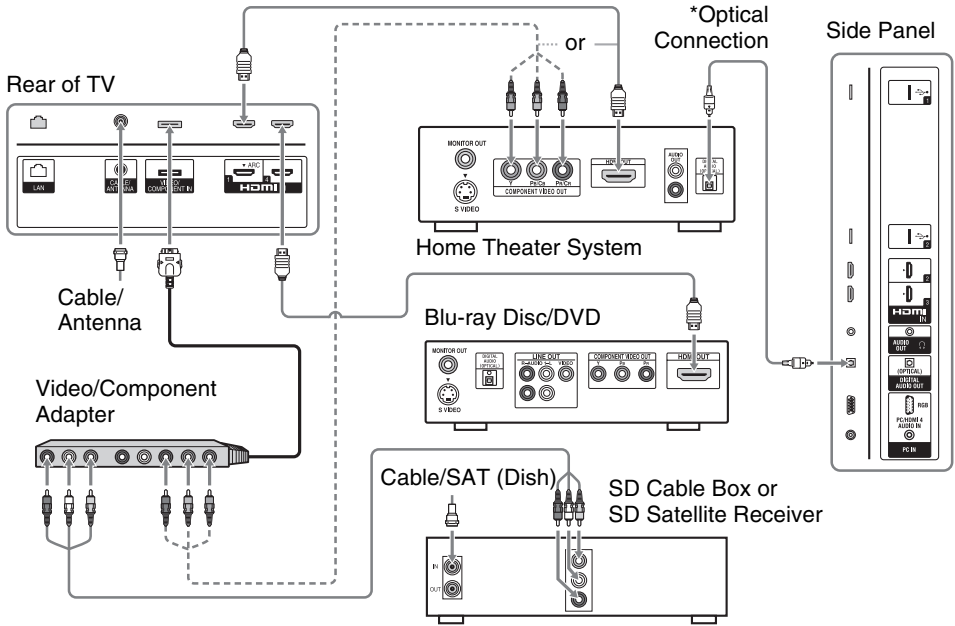

* The optical connection is only needed for A/V receivers that do not support ARC (Audio Return Channel).

Shown with PC Connection with SD VCR/DVD

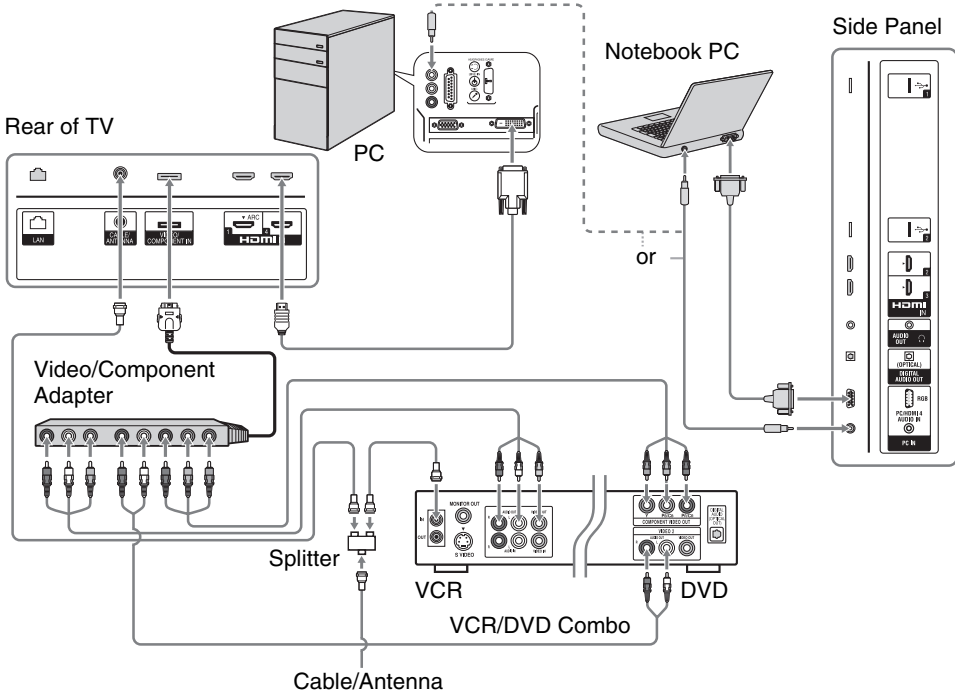

4: Securing the TV



Sony strongly recommends taking measures to prevent the TV from toppling over. Unsecured TVs may topple and result in property damage, serious bodily injury or even death.

Preventing the TV from Toppling

- Secure the TV to a wall and/or stand.
- Do not allow children to play or climb on furniture and TV sets.
- Avoid placing or hanging items on the TV.
- Never install the TV on:
 - slippery, unstable and/or uneven surfaces.
 - furniture that can easily be used as steps, such as a chest of drawers.
- Install the TV where it cannot be pulled, pushed, or knocked over.
- Route all AC power cords and connecting cables so that they are not accessible to curious children.

Recommended Measures to Secure the TV

Consider the following measures when securing your TV to a Stand (not supplied).

1 Secure the Stand for the TV.

Make sure the Stand can adequately support the weight of the TV. Use two angle braces (not supplied) to secure the stand. For each angle brace use the appropriate hardware to:

- Attach one side of the angle brace to the wall stud.

- Attach the other side to the Stand.

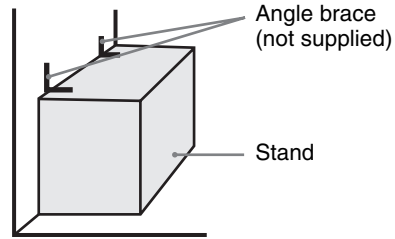

2 Secure the TV to the Stand.

Use the optional hardware listed as follows (not supplied):

- M4 machine screw (screwed into the TV's Table-Top Stand)
- A screw or similar (attach it to the Stand)
- Rope or chain (strong enough to support the weight of the TV). Make sure that there is no excess slack in the rope or chain.

An alternative way to secure the TV is with an optional Sony Support Belt Kit. The Sony Support Belt Kit is available as an optional accessory, depending on your TV model.

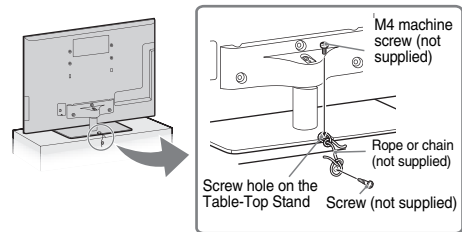

The length of the M4 machine screw differs depending on the rope or chain diameter. Please refer to below illustration.

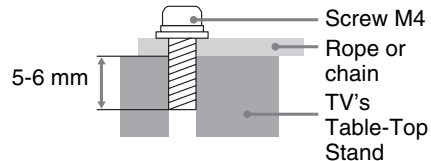



Contact Sony Customer Support to obtain the optional Support Belt Kit by providing your TV model name.

- For United States call: 1-800-488-7669 or visit: www.sony.com/accessories
- For Canada call: 1-877-899-7669

3 Anchor the TV to the Wall.

Anchor the TV to the wall by using bolts, wall anchor and chain (or rope).

Anchor bolts (M6) (not supplied)

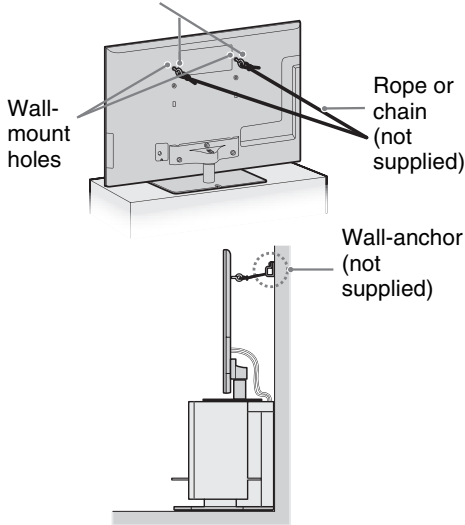

- Your TV is shipped with screws attached to the rear of the TV depending on the TV model. (They are fastened in the screw holes for wall mounting.) Be sure to remove the upper two screws prior to anchoring the TV on a wall.
- Securing the TV to the stand without securing the TV and the stand to the wall provides minimum protection against the TV toppling over. For further protection, be sure to follow the three measures recommended.

5: Bundling the cables



- Before bundling the cables, remove the cable holder from the AC cover (see step 1 and 2). Reuse the cable holder (see step 3) to bundle the other cables (see step 4).
- Do not bundle the AC power cord together with other cables.

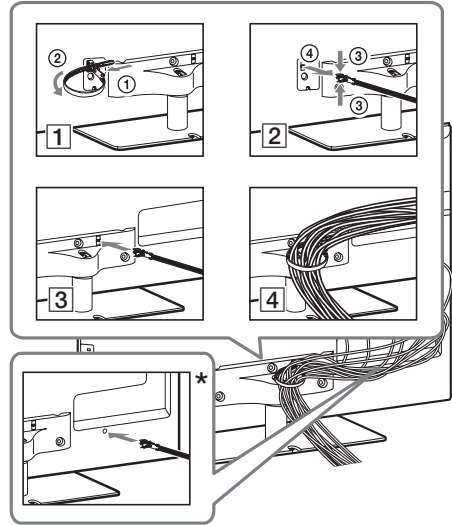

- * When installing on the wall, attach the cable holder under the terminals.

6: Running initial setup

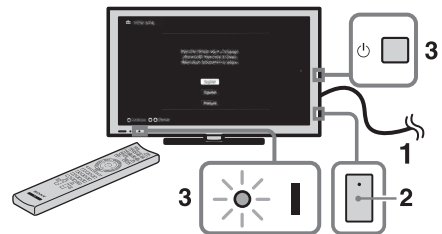

- 1 Complete your cable connections before proceeding with the **Initial Setup**.
Connect the TV to your nearest power outlet.

- 2 Check the **ENERGY SAVING** switch setting is on (●).
- 3 Press  (power) on the TV. The **I** (power) indicator will light green. When you switch the TV on for the first time, the **Language** menu appears on the screen.



- When you turn on the TV for the first time, the TV requires some internal processing for optimization before you can perform the initial setup. There will be no picture and sound, and the timer indicator on the front of the TV blinks orange for about 40 seconds. Do not turn off the TV during this process. This process has been completed at the factory on some TVs.

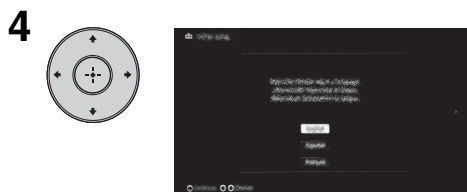
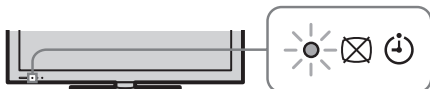

Follow the instructions on the screen.



- The **ENERGY SAVING** switch must be on (●) to set the clock and obtain program information for the Rovi On Screen Guide.
- **Home** mode sets the TV to settings optimized for home viewing (this setting is ENERGY STAR compliant).

- 5 Select **Continue** to scan for available channels and enable the **Rovi On Screen Guide™** feature. If you receive channels from a cable box or satellite receiver and do not wish to use the TV's built-in tuner, select **Skip**. Selecting **Skip** will disable the **Rovi On Screen Guide** feature, which is only available when the TV's tuner is used.



- If you skip the channel scan while in the setup menus, Rovi On Screen Guide will be disabled.

Using a Wall-Mount Bracket

Your TV can be mounted on a wall using a Wall-Mount Bracket (not supplied) out of the box as packaged. If the Table-Top Stand is attached to the TV, the TV may require detaching the Table-Top Stand; see “Detaching the Table-Top Stand from the TV” (page 11).

Prepare the TV for the Wall-Mount Bracket before making cable connections.

For product protection and safety reasons, Sony strongly recommends that you use the Wall-Mount Bracket designed for your TV and the installation should be performed by a Sony dealer or licensed contractor.

- Refer to “Compatible optional accessories information” (page 35).
- Follow the instruction guide provided with the Wall-Mount Bracket for your model. Sufficient expertise is required in installing this TV, especially to determine the strength of the wall for withstanding the TV's weight.

- Be sure to use the screws supplied with the Wall-mount bracket when attaching the mounting hooks to the TV set. The supplied screws are designed so that they are 8 mm to 12 mm in length when measured from the attaching surface of the mounting hook.

The diameter and length of the screws differ depending on the Wall-mount bracket model. Use of screws other than those supplied may result in internal damage to the TV set or cause it to fall, etc.

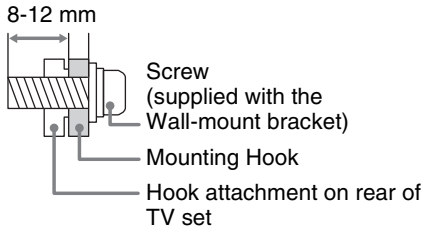

- Be sure to store the unused screws and Table-Top Stand in a safe place until you are ready to attach the Table-Top Stand. Keep the screws away from small children.



- Read the supplied Safety Booklet for additional safety information.

Installing the TV Against a Wall or Enclosed Area

Make sure that your TV has adequate ventilation. Allow enough space around the TV as shown in the illustration.

Installed with stand

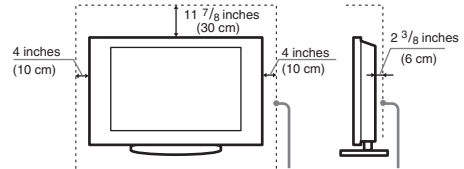

Leave at least this much space around the set.

Installed on the wall

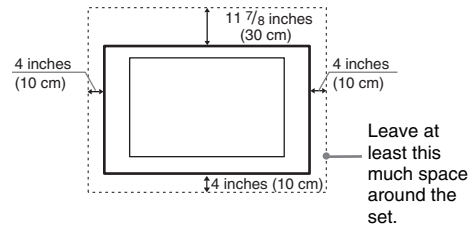

Leave at least this much space around the set.

Never install the TV set as follows:

Air circulation is blocked. Air circulation is blocked.

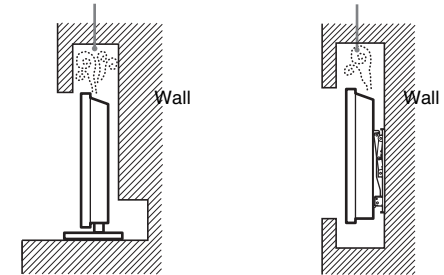

- Inadequate ventilation can lead to overheating of the TV and may cause damage to your TV or cause a fire.

Using Your BRAVIA TV

Watching the TV

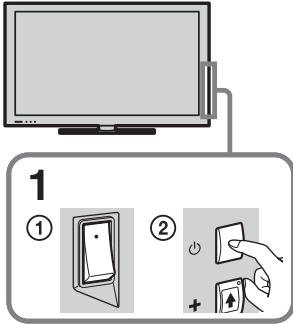

1 Turn on the TV.

- ① Check the **ENERGY SAVING** switch is set to on (●).
- ② Press (power) on the TV or on the remote control to turn on the TV. (You may use the * button located on the front or back of the remote control.)

* Button name differs by the remote control.

2 Select a TV channel or select an input.

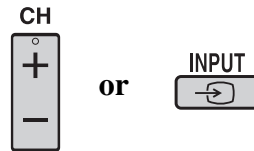

To use the Guide

Press **GUIDE** to display the **Rovi On Screen Guide** to view scheduled programs or to select a program to watch. Press again to exit the Guide.



To use 0-9

For example, to enter 2.1, press , and .

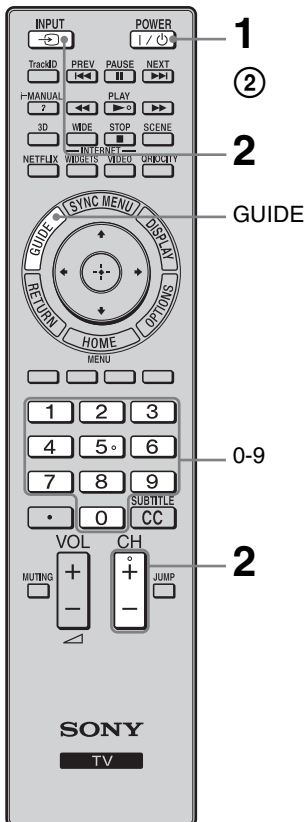

Parts and controls of the remote control

Use the supplied remote control to control your TV. Basic remote control operations are explained here. For details on all of the remote control functions, press **i-MANUAL** and see the built-in manual (i-Manual) (page 24).

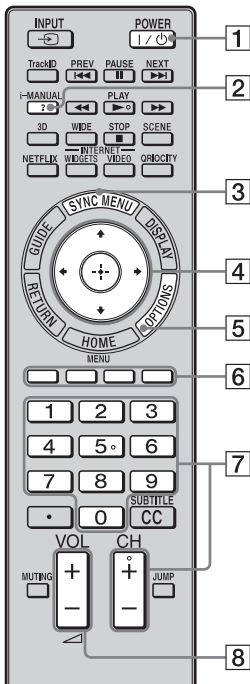

1 I/O

Press to turn the TV on and off from standby mode.

2 i-MANUAL

Displays the built-in manual (i-Manual).

3 SYNC MENU

Displays the BRAVIA Sync Menu to operate the BRAVIA Sync-compatible equipment that is connected to the TV.

4 ⬆/⬇/⬅/➡/⊕

Moves the on-screen cursor, and confirms the item.

5 OPTIONS

Displays a list of convenient functions and menu shortcuts. The menu items vary based on the current input and/or content.

6 Color buttons

When the color buttons are available, an operation guide appears on the screen.

7 CH +/-/Number buttons

Select channels in the TV mode.

8 VOL/▲ +/-

Adjusts the volume.

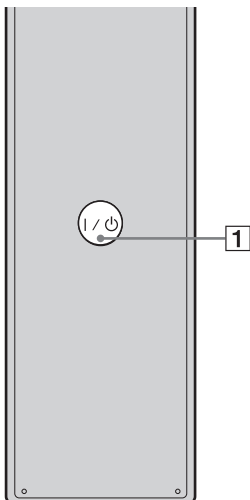

Rear of Remote Control

Selecting various functions and settings (Home Menu)

You can select the features of your TV from the Home menu.

See page 23 for the Home menu map.

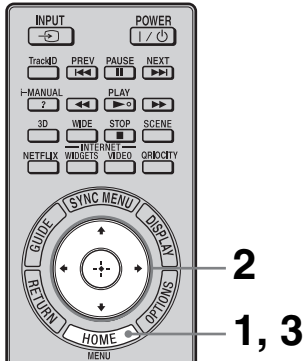

1 Press **HOME**.



2 Press **↑/↓/←/→/+** to select items.



To select items in the Home menu (e.g., selecting "Settings")

1 Press **←/→** to select **Settings**.

The contents of **Settings** are displayed on the right.

2 Press **↑/↓** to select **Picture & Display**.





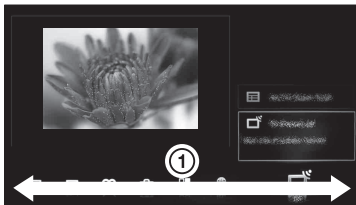





3 Press **+** to launch the menu. According to the screen instruction, press **↑/↓/←/→** to select items and press **+** to confirm.

3 Press **HOME** to exit.



Home menu map

After pressing **HOME** on the remote control, following icons are displayed as categories. The categories are available depending on your TV model, region, country and broadcasting conditions.

	TV	You can select a list of TV channels, or a program guide.
	Media	You can enjoy photo/music/video content via USB devices or the home network.
	Inputs	You can select equipment connected to the TV.
	Favorites/History	Provides quick access to your frequently used and recently viewed items, such as TV channels, external inputs or your media files.
	Settings	Contains all of the necessary configurations to customize your TV settings.
	Widgets	Provides access to Widgets.
	Applications	You can enjoy various applications such as Music Search , Internet Browser , etc.
	Qriocity	Provides access to the Qriocity online service.
	Internet Content	You can enjoy Internet content services.
	Recommendations	Presents recommendations for programs you may like, based on your viewing history.

Displaying Operating Instructions (i-Manual)

Operating instructions are built into your BRAVIA TV and can be displayed on the screen. To learn more about your TV features, access your i-Manual with the touch of a button.

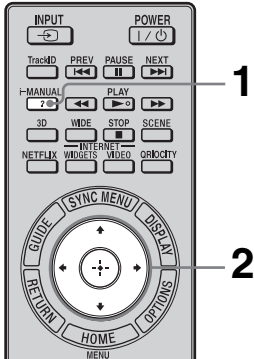

1 Press i-MANUAL.



2 Press $\uparrow/\downarrow/\leftarrow/\rightarrow/\oplus$ to navigate and select items.



To select items in the i-Manual

- 1 Press \uparrow/\downarrow to select an item.
The contents are displayed to the right as the second layer.
- 2 Press \rightarrow to move to the second layer.
- 3 Press \uparrow/\downarrow to select an item from the second layer.
A description of the item is displayed to the right.
If a third layer is available, repeat this step to display the details.
- 4 Press \rightarrow to select an item.
The content is displayed.

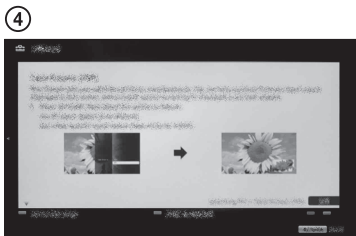
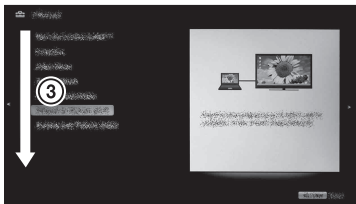
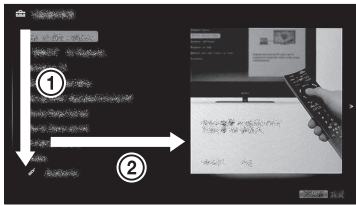

Description of the i-Manual screen

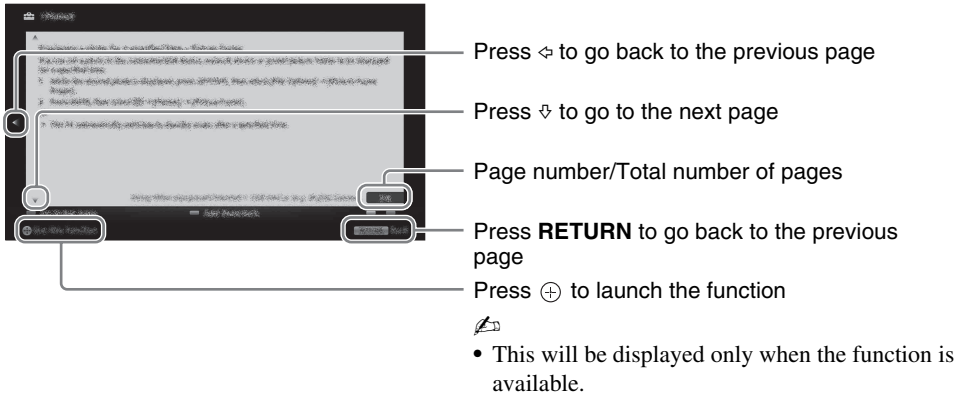

To use the bookmark

The i-Manual has a bookmark function. Pages can be bookmarked with the color buttons, according to the instructions at the bottom of the screen. To access your registered bookmarks, go to the top page of the i-Manual and select **Bookmarks**.

To memorize the last displayed page

i-Manual memorizes the last displayed page. When in the i-Manual screen, press **i-MANUAL** to return to the TV screen. If you press **i-MANUAL** again, the information you saw last time appears. For viewing from the top page of the i-Manual, return to the top page according to the instructions on screen, or press **HOME** and select **i-Manual** of **Settings** in the Home menu.

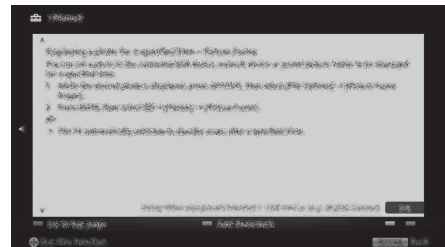

- Last page memory is automatically reset when you switch the TV to standby mode.

Programming the Remote Control (For RM-YD057 and RM-YD067 remote control users)

Your remote control can be programmed to use other equipment and is pre-programmed to operate the following Sony equipment.

Function Button	Sony Equipment	Code Number
DVD	DVD Player	31033
AMP	Receiver	52172
STB	Digital Satellite	01639

Programming Other Equipment

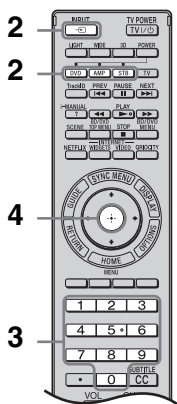

Follow the steps below to program your TV remote control.

- 1 Look for the code in the Manufacturer's Code List (refer to i-Manual) that corresponds to the equipment you would like to operate with the Sony remote control. If more than one code is provided, try programming the first code listed. If your equipment's code is not listed, visit <http://esupport.sony.com/remotecodes> for a more comprehensive list.
- 2 Press and hold **DVD**, **AMP** or **STB** function button simultaneously with \rightarrow button and release. When in the programming mode, the function button (**DVD**, **AMP**, **STB**) blinks for approximately 30 seconds until a code is entered.
- 3 Enter the five digit code using \square 0 - \square 9 while the function buttons (**DVD**, **AMP**, **STB**) are lit. If the code is not entered within 30 seconds, you must repeat step 2.
- 4 Press \oplus to confirm the code. If successfully programmed, the function button (**DVD**, **AMP**, **STB**) will blink twice, if not, it blinks five times.

Confirm the Programming

If you can turn your equipment on and off using the green **POWER** button, the programming is complete. If not, try the next code listed.



- In some cases, you may not be able to program your remote control. If this is the case, use your equipment's own remote control.
- Any of the function buttons (**DVD**, **AMP**, **STB**) can be programmed to operate other equipment regardless of the labeling. For example, if programmed with the correct code, a Blu-ray Disc player can be operated with the **DVD** button. This is useful if your equipment does not match any of the labeled buttons.

To reset the remote control to the factory default:

Press **SCENE**, **TV I/⏻** (TV POWER), and \oplus simultaneously. The four function buttons (**DVD**, **AMP**, **STB**, and **TV**) blink when successfully reset.

Network Setup

When you connect this TV to the Internet, you can enjoy multiple functions: displaying a photograph that shows its location on the map, enjoying Internet video, etc. For details on the functions, refer to the i-Manual.



- You will need to contract with an Internet service provider to connect to the Internet.

Preparing a wired network

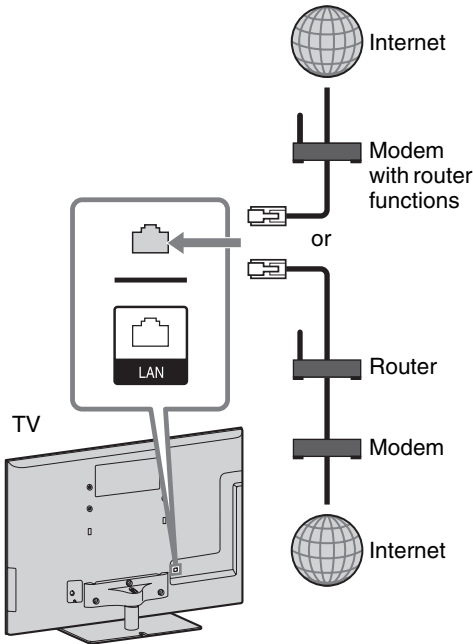

- For LAN connections, use a Category 7 cable (not supplied).

Preparing a wireless LAN

The built-in wireless LAN device allows you to access the Internet and your home network. With this feature, you can connect to a wireless LAN and enjoy the benefits of networking in a cable-free environment. Before setting up the wireless LAN function of the TV, be sure to set up a wireless LAN router.

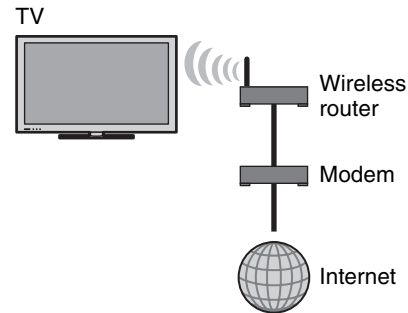

Setting up the Internet connection

Using the network feature you can connect the TV to the Internet. The setup procedure differs depending on the type of network and LAN router. Before setting up the Internet connection, be sure to set up a LAN router. Check your wireless LAN environment using the following chart.

Wireless LAN

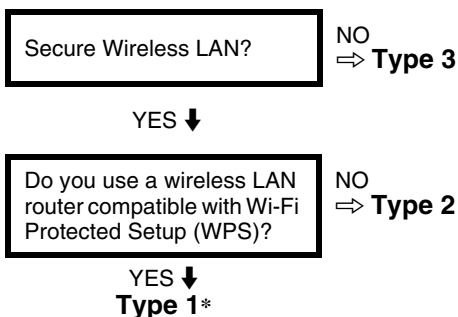

Wired LAN → Type 4

* Type 1 is easier to set up if your router has an automatic setting button, e.g. Air Station One-Touch Secure System (AOSS). Most of the latest routers have this function. Check your router.

Type 1: Follow the configuration for “Secured Network with Wi-Fi Protected Setup (WPS)”.



Type 2: Follow the configuration for “Secured Network without Wi-Fi Protected Setup (WPS)”.

Type 3: Follow the configuration for “Unsecured Network with Any Type of Wireless LAN Router”.

Type 4: Follow the configuration for “Wired network setup”.

Type 1: Secured network with Wi-Fi Protected Setup (WPS)

The WPS standard makes security of a wireless home network as straightforward as pressing the WPS button on the wireless LAN router. Before setting up a wireless LAN, check the location of the WPS button on the router and verify how to use it. For security purpose, **WPS (PIN)** provides a PIN code for your router. PIN code is renewed every time you select **WPS (PIN)**.

- 1 Press **HOME**, then select  > **Network > Network Setup**.
- 2 Select **Wireless Setup**.
- 3 Select **WPS (Push Button)** for Push Button method or **WPS (PIN)** for PIN method.
 -  Button name of the WPS may differ depending on the router (e.g. AOSS button).
- 4 Follow the instructions on the setup screen.

Type 2: Secured network without Wi-Fi Protected Setup (WPS)

To set up a wireless LAN, SSID (wireless network name) and security key (WEP or WPA key) will be required. If you do not know them, consult the instruction manual of your router.

- 1 Press **HOME**, then select  > **Network > Network Setup**.
- 2 Select **Wireless Setup**.

- 3 Select **Scan**, then select a network from the list of scanned wireless networks.
- 4 Follow the instructions on the setup screen.



- If you use WPS for network setup, the security settings of the wireless LAN router activate, and any equipment previously connected to the wireless LAN in a non-secure status will be disconnected from the network. In this case, activate the security settings of the disconnected equipment and then reconnect. Or, you can deactivate the security settings of the wireless LAN router, and then connect the equipment to a TV in a non-secure status.

Type 3: Unsecured network with any type of wireless LAN router

To set up a wireless LAN, SSID (wireless network name) will be required.

- 1 Press **HOME**, then select > **Network > Network Setup**.
- 2 Select **Wireless Setup**.
- 3 Select **Scan**, then select a network from the list of scanned wireless networks.
- 4 Follow the instructions on the setup screen.



- Security key (WEP or WPA key) will not be required because you do not need to select any security method in this procedure.

Type 4: Wired network setup

Enter the respective alphanumeric values for your router if necessary. The items that need to be set (e.g. IP Address, Subnet Mask, DHCP) may differ depending on the Internet service provider or router. For details, refer to the instruction manuals provided by your Internet service provider, or those supplied with the router.

- 1 Press **HOME**, then select > **Network > Network Setup**.
- 2 Select **Wired Setup**.
- 3 Select **Auto** to set the IP Address and proxy server automatically, or **Custom** to set them manually.
- 4 Follow the instructions on the setup screen.

Viewing the network status

You can confirm your network status.

- 1 Press **HOME**, then select > **Network > Network Setup**.
- 2 Select **View Network Status**.

If you cannot connect to the Internet

Use the diagnostic to check possible causes for network connection failures, and settings.

- 1 Press **HOME**, then select > **Network > Network Setup**.
- 2 Select **View Network Status**.

- 3 Select **Check Connection**.
This may take several minutes. You cannot cancel the diagnostic after selecting **Check Connection**.

Adjusting the server display settings

You can select home network servers to be displayed on the Home Menu. Up to 10 servers can be displayed in the Home Menu automatically.

- 1 Press **HOME**, then select  > **Network > Home Network Setup**.
- 2 Select **Show/Hide Media Servers**.
- 3 Select the server you want to display on the Home Menu, and adjust the settings.

If you cannot connect to your home network

The TV detects if the server is being correctly recognized when you cannot connect it to your home network. If the diagnostic results indicate a failure, check possible causes, and network connections and settings.

- 1 Press **HOME**, then select  > **Network > Home Network Setup**.
- 2 Select **Media Server Troubleshooting**.
The server diagnostic starts. When the server diagnostic is complete, the diagnostic result list appears.

Additional Information





Troubleshooting

When the  (standby) indicator is flashing, count how many times it flashes (interval time is three seconds).

Press  (power) on the TV to turn it off, disconnect the AC power cord, and contact Sony Customer Support (information provided on the front cover) with how many times the indicator flashes.

When the  (standby) indicator is not flashing, check the items in the table as follows.

Also refer to “Troubleshooting” in the i-Manual. If the problem persists, contact Sony Customer Support (information provided on the front cover).

Condition	Explanation/Solution
There is no picture (screen is dark) and no sound.	<ul style="list-style-type: none">• Check the antenna/cable connection.• Connect the TV to the AC power, and press  (power) on the TV.• If the  (standby) indicator lights up in red, press I/ (or TV I/) on the remote control.
Tiny black dots and/or bright dots appear on the screen.	<ul style="list-style-type: none">• The screen is composed of pixels. Tiny black dots and/or bright dots (pixels) on the screen do not indicate a malfunction.
Some programs cannot be tuned.	<ul style="list-style-type: none">• Check the antenna or dish.
The TV's power cannot be turned on.	<ul style="list-style-type: none">• Check to see the (●) mark on the ENERGY SAVING switch is pressed.
The TV turns off automatically (the TV enters standby mode).	<ul style="list-style-type: none">• Check if the Sleep Timer, Timer, or Idle TV Standby is activated.• The Auto Shut-off setting may be set to On. If Auto Shut-off is activated and TV receives no signal, the TV will automatically enter standby mode in 15 minutes. Check Auto Shut-off is activated under Eco feature of this TV. (United States and Canada only)• Check if Presence Sensor in Eco is activated. When no viewer is detected in front of the TV for a preset time, the picture automatically turns off, while leaving only the TV sound on. Additionally, after 30 minutes in picture off mode, the TV will switch to standby mode.

Condition	Explanation/Solution
The remote control does not function.	<ul style="list-style-type: none"> • Replace the batteries. • Your TV may be in SYNC mode. Press SYNC MENU, select TV Control and then select Home (Menu) or Options to control the TV.
The TV and its surrounding become warm.	<ul style="list-style-type: none"> • When the TV is used for an extended period of time, the TV and its surroundings may become warm to touch. This is not a malfunction of the TV.
The Parental Lock password has been forgotten.	<ul style="list-style-type: none"> • Enter 4357 for the PIN code. (PIN code 4357 is always accepted.)

How to Care for Your BRAVIA

Safety is very important. Please read and follow the safety documentation (Safety Booklet) separately provided.

Unplug the TV and other connected equipment from the wall outlet before you begin cleaning your TV.

- Wipe the LCD screen gently with a soft cloth.
- Stubborn stains may be removed with a cloth slightly moistened with a solution of mild soap and warm water.
- If using a chemically pretreated cloth, please follow the instruction provided on the package.
- Never use strong solvents such as a thinner, alcohol or benzine for cleaning.
- Do not plug in the TV into the wall outlet until the moisture from cleaning has evaporated.



The TV should also be placed on a stable surface to prevent it from toppling over (see page 15). If you have young children or pets at home, check regularly to ensure the TV is securely fastened.

Specifications

System	
Television system	NTSC: American TV standard ATSC (8VSB terrestrial): ATSC compliant 8VSB QAM on cable: ANSI/SCTE 07 2000 (Does not include CableCARD functionality)
Channel coverage	Analog terrestrial: 2 - 69 / Digital terrestrial: 2 - 69 Analog Cable: 1 - 135 / Digital Cable: 1 - 135
Panel system	LCD (Liquid Crystal Display) Panel
Speaker output	10 W + 10 W + 10 W + 10 W (for KDL-60NX720) 10 W + 10 W + 10 W (except KDL-60NX720)
Input/Output jacks	
CABLE/ANTENNA	75-ohm external terminal for RF inputs
VIDEO IN 1/2	VIDEO / AUDIO
COMPONENT IN	YPbPr (Component Video) / Signal format: 480i, 480p, 720p, 1080i, 1080p AUDIO
HDMI IN 1/2/3/4	HDMI: Video: 480i, 480p, 720p, 720/24p/30p, 1080i, 1080p, 1080/24p/30p Audio: Two channel linear PCM 32, 44.1 and 48 kHz, 16, 20 and 24 bits, Dolby Digital Analog audio input (minijack) (HDMI IN 4 only) ARC (Audio Return Channel) (HDMI IN 1 only)
AUDIO OUT/Headphones	500 mVrms (typical) Stereo mini jack / Impedance: ≥ 16 ohms
DIGITAL AUDIO OUT (OPTICAL)	PCM/Dolby Digital optical signal
PC IN	D-sub 15-pin, analog RGB
PC/HDMI 4 AUDIO IN	Stereo mini jack
LAN	10BASE-T/100BASE-TX connector (Connection speed may differ depending on the network environment. 10BASE-T/100BASE-TX communication rate and communication quality are not guaranteed for this TV.)
USB/DLNA	Refer to the i-Manual for supported format.
REMOTE (HX929 series only)	RS232C, D-sub 9 pin. This jack is for receiving the external control signal.

Model name KDL-/XBR-	60NX720	55HX929	55HX820	55NX720
Power and others				
Power requirement	110-240 V AC, 50/60 Hz (U.S.A./Canada 120 V AC, 60 Hz)			
Power consumption in use	182 W	179 W	177 W	181 W
in use in DAM*	0.02 kWh/Day (You may hear a clicking noise during the download but this is normal.)			
in standby	Less than 0.2 W with 120 V AC and less than 0.3 W with 240 V AC	Less than 0.3 W with 120 V AC and less than 0.4 W with 240 V AC		Less than 0.2 W with 120 V AC and less than 0.3 W with 240 V AC
Screen size (inches measured diagonally)	60 inches	54.6 inches (55 class)		
Display resolution	1,920 dots (horizontal) \times 1,080 lines (vertical)			
Speaker				
Full range (mm)	20 \times 90 (2)	30 \times 150 (2)	20 \times 75 (4)	20 \times 90 (2)
(inches)	$1\frac{3}{16} \times 3\frac{5}{8}$ (2)	$1\frac{3}{16} \times 6$ (2)	$1\frac{3}{16} \times 3$ (4)	$1\frac{3}{16} \times 3\frac{5}{8}$ (2)
Woofer (mm)	Φ 60 (2)	40 \times 90 (1)	40 \times 90 (1)	Φ 60 (1)
(inches)	Φ 2 $\frac{3}{8}$ (2)	$1\frac{5}{8} \times 3\frac{5}{8}$ (1)	$1\frac{5}{8} \times 3\frac{5}{8}$ (1)	Φ 2 $\frac{3}{8}$ (1)
Dimensions with stand (mm)	1,405 \times 874 \times 304	1,278 \times 803 \times 308	1,280 \times 804 \times 305	1,281 \times 805 \times 308
(inches)	55 $\frac{3}{8} \times 34\frac{1}{2} \times 12$	50 $\frac{3}{8} \times 31\frac{5}{8} \times 12\frac{1}{4}$	50 $\frac{1}{2} \times 31\frac{3}{4} \times 12\frac{1}{8}$	50 $\frac{1}{2} \times 31\frac{3}{4} \times 12\frac{1}{4}$
without stand (mm)	1,405 \times 844 \times 33	1,278 \times 771 \times 38	1,280 \times 774 \times 27	1,281 \times 774 \times 27
(inches)	55 $\frac{3}{8} \times 33\frac{1}{4} \times 1\frac{5}{16}$	50 $\frac{3}{8} \times 30\frac{3}{8} \times 1\frac{1}{2}$	50 $\frac{1}{2} \times 30\frac{1}{2} \times 1\frac{1}{8}$	50 $\frac{1}{2} \times 30\frac{1}{2} \times 1\frac{1}{8}$
wall-mount hole pattern (mm)	400 \times 300		300 \times 300	
wall-mount screw size (mm)	M6 (length: refer to diagram on page 18.)			

Model name KDL-/XBR-	60NX720	55HX929	55HX820	55NX720
Mass	with stand (kg)/(lb.) 34.5 / 76.0	31.6 / 69.7	28.3 / 62.4	28.3 / 62.4
	without stand (kg)/(lb.) 28.8 / 63.5	26.1 / 57.5	23.2 / 51.2	23.1 / 50.9
Supplied accessories	See "Checking the accessories" (page 8).			
Optional accessories	Connecting cables Support Belt Kit Wall-Mount Bracket: SU-WL700 (except KDL-60NX720) SU-WL500 Wall-Hanging Bracket: SU-WH500 TV Stand: SU-B551S (XBR-55HX929, KDL-55HX820, KDL-55NX720) 3D Glasses: TDG-BR250/TDG-BR200/TDG-BR100/TDG-BR50 USB Wireless LAN Adapter			
Operating temperature	32 °F – 104 °F (0 °C – 40 °C)			

Model name KDL-/XBR-	46HX929	46HX820	46NX720
Power and others			
Power requirement	110-240 V AC, 50/60 Hz (U.S.A./Canada 120 V AC, 60 Hz)		
Power consumption	138 W	142 W	123 W
in use	0.02 kWh/Day		
in DAM*	(You may hear a clicking noise during the download but this is normal.)		
in standby	Less than 0.2 W with 120 V AC and less than 0.4 W with 240 V AC		Less than 0.2 W with 120 V AC and less than 0.3 W with 240 V AC
Screen size (inches measured diagonally)	46 inches		
Display resolution	1,920 dots (horizontal) × 1,080 lines (vertical)		
Speaker			
Full range	(mm) 30 × 150 (2)	20 × 75 (4)	20 × 90 (2)
	(inches) 1 3/16 × 6 (2)	13/16 × 3 (4)	13/16 × 3 5/8 (2)
Woofer	(mm) Φ 60 (1)	40 × 90 (1)	Φ 60 (1)
	(inches) Φ 2 3/8 (1)	1 5/8 × 3 5/8 (1)	Φ 2 3/8 (1)
Dimensions	with stand (mm) 1,081 × 692 × 258	1,083 × 693 × 255	1,084 × 694 × 258
	(inches) 42 5/8 × 27 1/4 × 10 1/4	42 5/8 × 27 3/8 × 10 1/8	42 3/4 × 27 3/8 × 10 1/4
	without stand (mm) 1,081 × 660 × 38	1,083 × 663 × 27	1,084 × 663 × 27
	(inches) 42 5/8 × 26 × 1 1/2	42 5/8 × 26 1/8 × 1 1/8	42 3/4 × 26 1/8 × 1 1/8
wall-mount hole pattern (mm)	300 × 300		
wall-mount screw size (mm)	M6 (length: refer to diagram on page 18.)		
Mass	with stand (kg)/(lb.) 24.0 / 52.9	21.1 / 46.5	20.2 / 44.5
	without stand (kg)/(lb.) 19.4 / 42.8	16.8 / 37.1	15.8 / 34.8
Supplied accessories	See "Checking the accessories" (page 8).		
Optional accessories	Connecting cables Support Belt Kit Wall-Mount Bracket: SU-WL700/SU-WL500 Wall-Hanging Bracket: SU-WH500 TV Stand: SU-B461S 3D Glasses: TDG-BR250/TDG-BR200/TDG-BR100/TDG-BR50 USB Wireless LAN Adapter		
Operating temperature	32 °F – 104 °F (0 °C – 40 °C)		

* Download Acquisition Mode (DAM) is used for software updates and/or collecting data for Rovi On Screen Guide.

- Optional accessories availability depends on its stock.
- Design and specifications are subject to change without notice.

Declaration of Conformity

Trade Name: SONY
Model: KDL-60NX720/XBR-55HX929/
KDL-55HX820/KDL-55NX720/XBR-46HX929/
KDL-46HX820/KDL-46NX720
Responsible Party: Sony Electronics Inc.
Address: 16530 Via Esprillo,
San Diego, CA 92127 U.S.A.
Telephone Number: 858-942-2230

This device complies with part 15 of the FCC rules. Operation is subject to the following two conditions:
(1) This device may not cause harmful interference, and (2) this device must accept any interference received, including interference that may cause undesired operation.

For customers in Canada

This Class B digital apparatus complies with Canadian ICES-003.

FCC Related Information

This equipment has been tested and found to comply with the limits for a Class B digital device, pursuant to Part 15 of the FCC Rules. These limits are designed to provide reasonable protection against harmful interference in a residential installation. This equipment generates, uses and can radiate radio frequency energy and, if not installed and used in accordance with the instructions, may cause harmful interference to radio communications. However, there is no guarantee that interference will not occur in a particular installation. If this equipment does cause harmful interference to radio or television reception, which can be determined by turning the equipment off and on, the user is encouraged to try to correct the interference by one or more of the following measures:

- Reorient or relocate the receiving antenna.
- Increase the separation between the equipment and receiver.
- Connect the equipment into an outlet on a circuit different from that to which the receiver is connected.
- Consult the dealer or an experienced radio/TV technician for help.

Pursuant to FCC regulations, you are cautioned that any changes or modifications not expressly approved in this manual could void your authority to operate this equipment.

Safety and Regulatory

This equipment complies with FCC/IC radiation exposure limits set forth for an uncontrolled environment. This equipment should be installed and operated with minimum distance 20 cm between the radiator and your body (excluding extremities: hands, wrists and feet).

This device and its antenna(s) must not be co-located or operating with any other antenna or transmitter except Grant condition.

Note

This television includes a QAM demodulator which should allow you to receive unscrambled digital cable television programming via subscription service to a cable service provider. Availability of digital cable television programming in your area depends on the type of programming and signal provided by your cable service provider.

Compatible optional accessories information

Use the following Sony optional accessories with your TV model.

	Sony TV Model No.		
KDL-/XBR-	60NX720	55HX929 55HX820 55NX720	46HX929 46HX820 46NX720
Sony Wall-Mount Bracket Model No.*1	SU-WL500	SU-WL700/SU-WL500	
Sony Wall-Hanging Bracket Model No.*1	SU-WH500		
Sony TV Stand No.*2	—	SU-B551S	SU-B461S

Use with other optional accessories may cause instability and could result in property damage or injury.

*1 For instructions on using with your TV please go to <http://esupport.sony.com> for your TV model and download “Additional Information for Using Sony Wall-Mount Bracket” or “Additional Information for Using Sony Wall-Hanging Bracket”.

*2 Some of these TV stand models may not be available in your area.

To Customers

Sufficient expertise is required for TV installations. Be sure to subcontract the installation to a Sony dealer or licensed contractor and pay adequate attention to safety during the installation.

For Your Convenience

Online Registration:	Be sure to register your TV. United States http://productregistration.sony.com Canada http://www.SonyStyle.ca/registration
Software Updates:	Your TV is capable of receiving software updates. For the latest information about software updates for your TV, visit: United States http://www.sony.com/tvsupport Canada http://www.sony.ca/support NOTE: If your TV is connected to the Internet, you can check for software updates by selecting Settings, Product Support and then Automatic Software Update .

