

SONY[®]

BRAVIA

LCD Digital Color TV

Operating Instructions

KDL-32L5000
KDL-26L5000

Sony Customer Support

U.S.A.: www.sony.com/tvsupport
Canada: www.sony.ca/support

United States
1.800.222.SONY

Canada
1.877.899.SONY

Sony will work to resolve
your questions more quickly than your retailer.

**Please Do Not Return
the Product to the Store**

Owner's Record

The model and serial numbers are located at the rear of the TV. Record these numbers in the spaces provided below. Refer to them whenever you call upon your Sony dealer regarding this TV.

Model Name

Serial No.

Your BRAVIA TV is ENERGY STAR qualified in the "Home" mode.

It meets strict energy efficiency guidelines set by the U.S. Environmental Protection Agency and Department of Energy. ENERGY STAR is a joint program of these government agencies, designed to promote energy efficient products and practices.



- When the TV is initially set up, it is designed to meet ENERGY STAR requirements.
- Changes to certain features, settings, and functionalities of this TV (i.e. Picture/Sound, Power Savings) can slightly change the power consumption.

Depending upon such changed settings, the power consumption may increase which possibly could exceed the limits required for the ENERGY STAR qualification.

Compatible Wall Mount Bracket Information

Use the following Sony WALL-MOUNT BRACKET with your TV model.

	Sony TV Model No.	
	KDL-26L5000	KDL-32L5000
Sony Wall-Mount Bracket Model No.	SU-WL100	SU-WL500

Use with other WALL-MOUNT BRACKETS may cause instability and could result in property damages or injury.

Cleaning

When cleaning, be sure to unplug the power cord to avoid any chance of electric shock.

- Wipe the LCD screen gently with a soft cloth.
- Stubborn stains may be removed with a cloth slightly moistened with a solution of mild soap and warm water.
- If using a chemically pretreated cloth, please follow the instruction provided on the package.
- Never use strong solvents such as a thinner, alcohol or benzene for cleaning.
- See the supplied Safety Booklet for additional information.

CAUTION

To prevent electric shock and blade exposure, do not use this polarized AC plug with an extension cord, receptacle or other outlet unless the blades can be fully inserted.

- Operate the TV only on 120-240 V AC.

Licensing Information

Macintosh is a trademark of Apple Inc., registered in the U.S. and other countries.

HDMI, the HDMI logo and High-Definition Multimedia Interface are trademarks or registered trademarks of HDMI Licensing, LLC.

Ferguson Patent Properties, LLC:

U.S. Patent No. 5,717,422

U.S. Patent No. 6,816,141

Manufactured under license from Dolby Laboratories. Dolby and the double-D symbol are trademarks of Dolby Laboratories.

Blu-ray Disc is a trademark.

"BRAVIA", BRAVIA, BRAVIA Sync, and  are trademarks or registered marks of Sony Corporation.

"PLAYSTATION" is a registered trademark and "PS3" is a trademark of Sony Computer Entertainment Inc.



This manual is for the 26 and 32 class BRAVIA KDL-L5000 series models with screen size measured diagonally. The 32 class has a 31.5 inch viewable image size (measured diagonally).

Contents

Introducing Your New BRAVIA®

Welcome to the World of BRAVIA®	4
Experiencing Stunning HD with Your BRAVIA	4
The Four Steps to a Stunning HD Experience	5
TV Feature Highlights	5

Getting Started

Setting Up Your TV	6
Locating Inputs and Outputs	7
Connecting the TV	9
Connecting Other Equipment	12
Bundling the Connecting Cables	13
When Installing the TV Against a Wall or Enclosed Area	13
Securing the TV	14
Running Initial Setup	16

Operating the TV

Using the Remote Control	17
Remote Control Button Description	18
TV Controls and Indicators	20

Using Features

Using BRAVIA Sync with Control for HDMI	21
Using PIP Feature	22
Favorites	22
Wide Mode	23
Wide Mode with PC	23
Inputs	24

Using the Menus

Navigating through TV Menus	25
Using the Picture Settings	26
Using the Sound Settings	27
Using the Screen Settings	28
Using the Channel Settings	30
Using the Parental Lock Settings	31
Using the Setup Settings	34

Other Information

PC Input Signal Reference Chart for PC and HDMI IN 1/2/3	37
Preparing the TV for Wall-Mounting	38
Troubleshooting	39
Important Notices	43
Specifications	44
Index	45



Customer Support

United States
<http://www.sony.com/tvsupport>
Canada
<http://www.sony.ca/support>

On-line Registration

United States
<http://productregistration.sony.com>
Canada
<http://www.SonyStyle.ca/registration>

Introducing Your New BRAVIA®

Welcome to the World of BRAVIA®

Thank you for choosing this Sony BRAVIA® high-definition television. Use the documentations listed below to get the most out of your TV.



Safety Booklet

Contains precautionary measures to keep you and your TV safe. Read this information prior to setting up your TV.



Quick Setup Guide

Provides TV setup information with sample connection diagrams and TV features.



Operating Instructions

Provides the most detailed information to operate your TV.

Experiencing Stunning HD with Your BRAVIA

The quality of the image you see on your **BRAVIA** TV is only as good as the quality of the signal it receives. To experience the stunning detail of your new **BRAVIA** TV, you need access to HD programming. Your **BRAVIA** TV can receive and display HD programming from:

- Over-the-air broadcasting via HD-quality antenna
- HD cable subscription
- HD satellite subscription
- Blu-ray Disc™ player or other HD compatible external equipment

Contact your cable or satellite provider for information on upgrading to HD programming.

The Four Steps to a Stunning HD Experience

Set, Sound, Source, and Setup

Along with your **BRAVIA TV set**, a complete HD system requires an HD **sound** system, a **source** of HD programming, and a proper connection **setup**. Refer to the Quick Setup Guide, enclosed separately, for connecting optional equipment.



You can enjoy crisp, clear images, smooth movement, and high-impact visuals from 1080 HD signals as shown here.

When you compare a high-definition signal to a standard analog signal, you will notice a big difference in picture quality. If black bars appear as shown here, press **WIDE** on the remote control to fill the screen.

TV Feature Highlights

Your **BRAVIA** comes with many convenient features, such as:

- **BRAVIA Sync:** Allows your **BRAVIA TV** to communicate with other Sony equipment supporting the **Control for HDMI** function (page 21).
- **PIP (Picture in Picture):** You can work on your PC and watch your favorite TV program simultaneously (page 22).
- **Favorites:** Your favorite channels and inputs are at your finger tips for easy access (page 22).
- **Auto Wide Mode:** Set your TV to automatically adjust the screen based on the signal resolution (page 23).
- **Input Selection:** Allows you to easily switch between the connected equipment (page 24).

Getting Started

Setting Up Your TV

The TV is packaged with a detached Table-Top Stand so you can mount the TV to a wall right away. If you are not mounting the TV to a wall, you will need to attach the Table-Top Stand. Use a Philips screwdriver and the supplied screws to complete the task. Look for the attachment instruction taped to the TV unit.

Be sure to consider the following while setting up your TV:

- Disconnect all cables when carrying the TV.
- Carry the TV with the adequate number of people; larger size TVs require two or more people.
- Placement of the hands carrying the TV is very important for safety and to avoid damage.

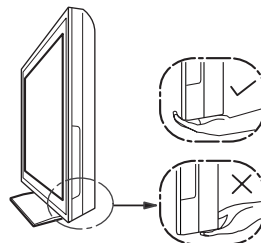
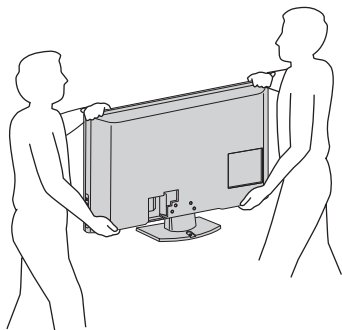

- Adequate ventilation is necessary (see page 13).
- For best picture quality, do not expose the screen to direct illumination or sunlight.
- Avoid installing the TV in a room with reflective wall and floor materials.
- Avoid moving the TV from a cold area to a warm area. Sudden room temperature changes may cause moisture condensation. This may cause the TV to show poor picture and/or poor color. Should this occur, allow moisture to evaporate completely before powering on the TV.



- For additional safety information, read the supplied Safety and Regulatory Booklet.
- When cable connection is completed, be sure to secure the TV to a stable surface or mount it to a wall. The designated Sony wall-mount bracket model is available on page 2 of this manual. For details on securing the TV and items listed above, see page 14.

Locating Inputs and Outputs

Side Panel

Rear Panel

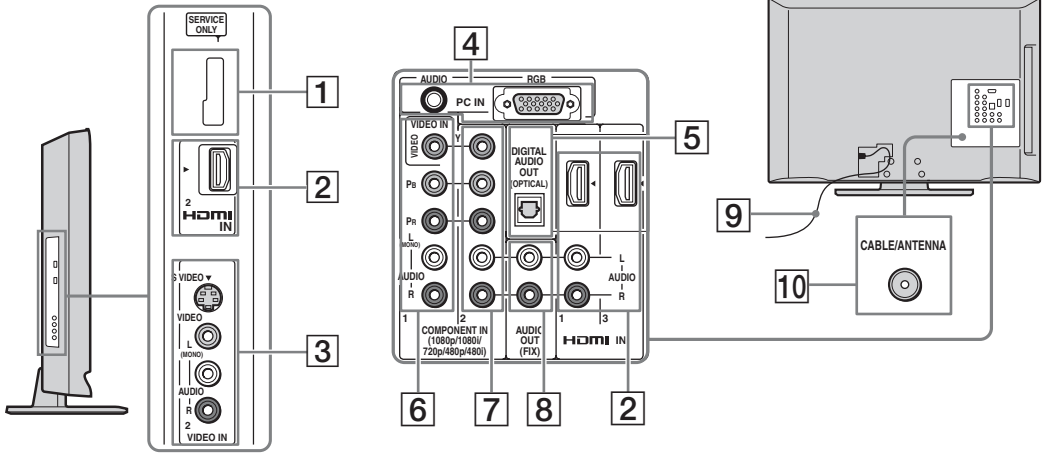

Item	Description
1 SERVICE	This port is for service only.
2 HDMI IN 1/2/3 L-AUDIO-R	HDMI (High-Definition Multimedia Interface) provides an uncompressed, all-digital audio/video interface between this TV and any HDMI-equipped audio/video equipment, such as a set-top box, DVD player, and A/V receiver. HDMI supports enhanced, or high-definition video, plus digital audio. Be sure to use only an HDMI cable that bears the HDMI logo. Use the HDMI IN 1 port when connecting DVI equipment. Use a DVI-to-HDMI cable or adapter (not supplied). Equipment using a DVI connection also requires an additional audio connection using an audio cable connected to AUDIO (L/R).
3 VIDEO IN 2 S VIDEO VIDEO/L (MONO)-AUDIO-R	Connects to the S VIDEO output jack of video equipment. If both composite video and S VIDEO are connected, S VIDEO signal has priority. If you have mono equipment, connect its audio output port to the TV's L (MONO) audio input port. Use VIDEO IN 2 with AUDIO L (mono) and R.
4 PC IN (RGB/AUDIO)	Connects to a personal computer's video and audio output connector. Can also be connected to other analog RGB equipment. See "PC Input Signal Reference Chart" on page 37 for the signals that can be displayed. For some Apple Macintosh computers, it may be necessary to use an adapter (not supplied). If an adapter is used, connect the adapter to the computer before connecting the HD15-HD15 cable. You may need to adjust the TV settings or your PC's resolution and timing. See page 11 for information on how to setup your PC to this TV.
5 DIGITAL AUDIO OUT (OPTICAL)	Connects to the optical audio input of a digital audio equipment that is PCM/Dolby* Digital compatible.

* Manufactured under license from Dolby Laboratories. "Dolby" and the double-D symbol are trademarks of Dolby Laboratories.

<i>Item</i>	<i>Description</i>
6 VIDEO IN 1/ COMPONENT IN 1 (1080p/1080i/ 720p/480p/480i)/ L (MONO)- AUDIO-R	This input port can be used as a composite video input (VIDEO 1) or as a component video input (COMPONENT 1). For composite use, connect the yellow jack to Y/Video for video and use audio L (mono) and R for audio signal. For component connection, use Y, Pb, Pr for video signals and also connect the audio L (mono) and R for audio signal. This TV can auto detect and switch between the VIDEO 1 and COMPONENT 1 when VIDEO 1 or COMPONENT 1 is connected. To set to auto detection, press MENU and go to the Setup settings. Select the Video/Component 1 Selection option then set to Auto .
7 COMPONENT IN 2 (1080p/1080i/ 720p/480p/480i)/ L-AUDIO-R	Component video provides better picture quality than the S Video and composite video. Audio connection is required for the COMPONENT IN ports, connect audio (L/R).
8 AUDIO OUT (FIX) L/R	Connects to the left and right audio input jacks of your analog audio equipment. You can use these outputs to listen to your TV's audio through your stereo system.
9 AC power cord	Plug the cord into the nearest wall outlet.
10 CABLE/ ANTENNA	RF input that connects to your Cable or VHF/UHF antenna.



- An HDMI or Component video (YPbPr) connection is required to view 480i, 480p, 720p, 1080i and 1080p video formats. 1080/24p is available only with HDMI connection. This TV displays all picture format types in a resolution of 1,366 dots × 768 lines.

Connecting the TV

Cable System or VHF/UHF Antenna System

You can enjoy high-definition and standard-definition digital programming (if available in your area) along with standard-definition analog programming.

This TV is capable of receiving unscrambled digital programming for both cable (QAM and 8VSB) and external VHF/UHF antenna (ATSC).

Cable or VHF/UHF (or VHF only)



- It is strongly recommended that you connect the CABLE/ANTENNA input using a 75-ohm coaxial cable to receive optimum picture quality. A 300-ohm twin lead cable can easily be affected by radio frequency interference, resulting in signal degradation.

Cable System and VHF/UHF Antenna System

Use an optional A-B RF switch (not supplied) to switch between the cable and over-the-air antenna programming, as indicated below.

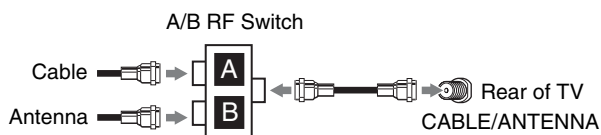

- Be sure to set the **Signal Type** setting to **Cable** or **Antenna** found under the **Channel** settings for your input signal (see page 30).

HD Cable Box/HD Satellite Box

You can enjoy high-definition programming by subscribing to a high-definition cable service or a high-definition satellite service. For the best possible picture, make sure you connect this equipment to your TV via the HDMI or component video (with audio) input located on the back of your TV.

Shown with HDMI Connection

Rear of TV

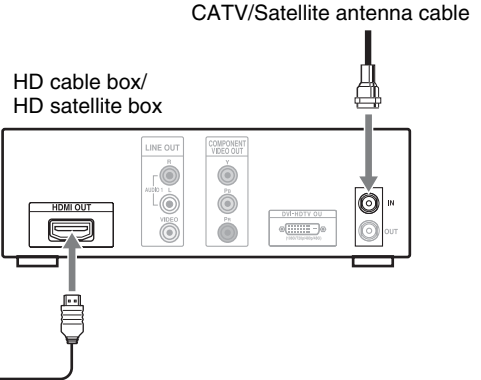
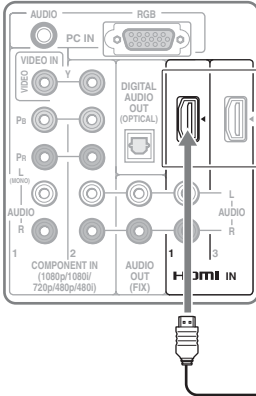

Shown with DVI Connection

Rear of TV

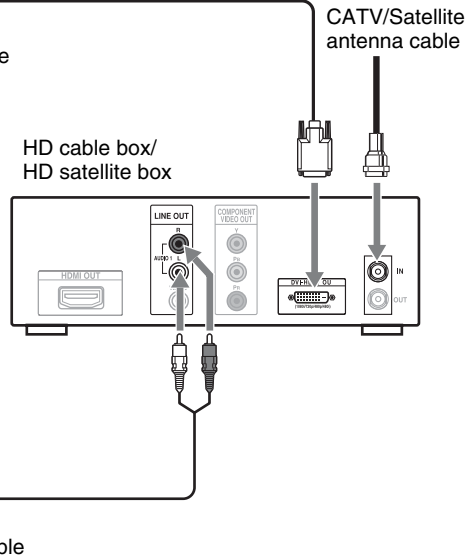
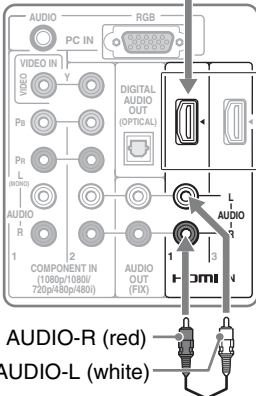

- If your equipment has a DVI output and not an HDMI output, connect the DVI output to the HDMI IN 1 (with DVI-to-HDMI cable or adapter) and connect the audio output to the AUDIO IN (L/R) of HDMI IN 1. For details, see page 7.

Shown with Component Connection

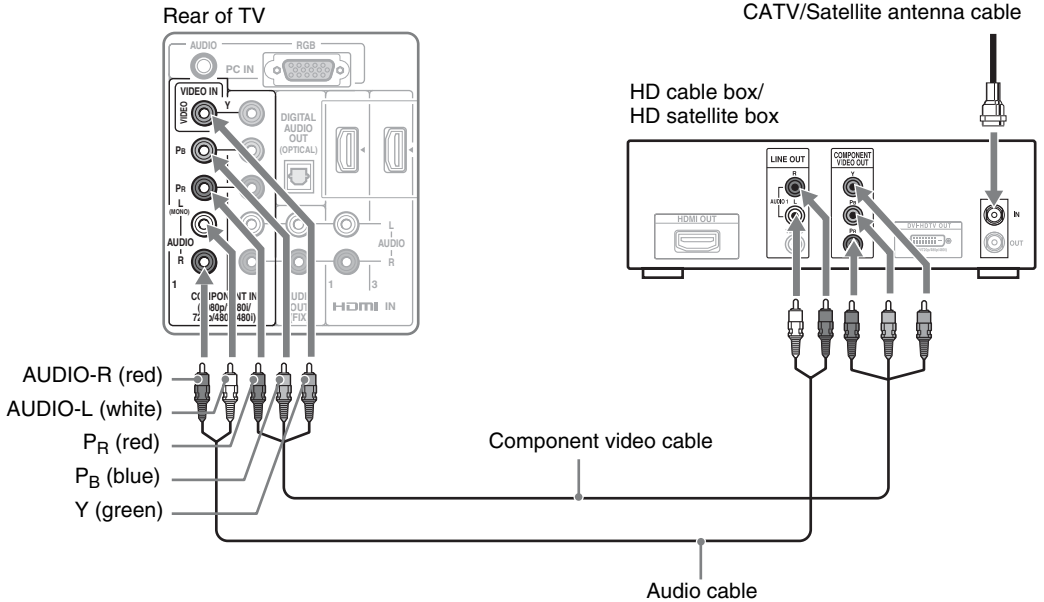

PC

Use the TV as a monitor for your PC by connecting an HD15-HD15 cable as shown below. This TV can also be connected to a PC with a DVI or HDMI output. (Refer to the separate Quick Setup Guide.)

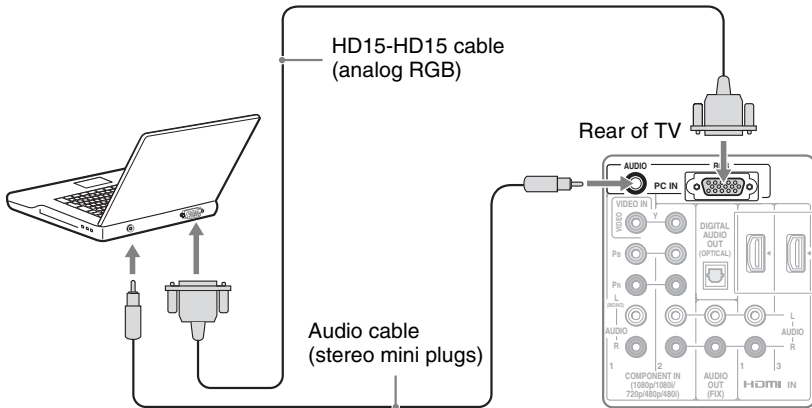

- Connect the PC IN jack to the PC using an HD15-HD15 cable with ferrite core (analog RGB) and audio cable (see page 7).
- The TV enters the standby mode automatically when the PC is connected to the TV and no signal has been output from the PC for more than 30 seconds (see page 34).

Connecting Other Equipment

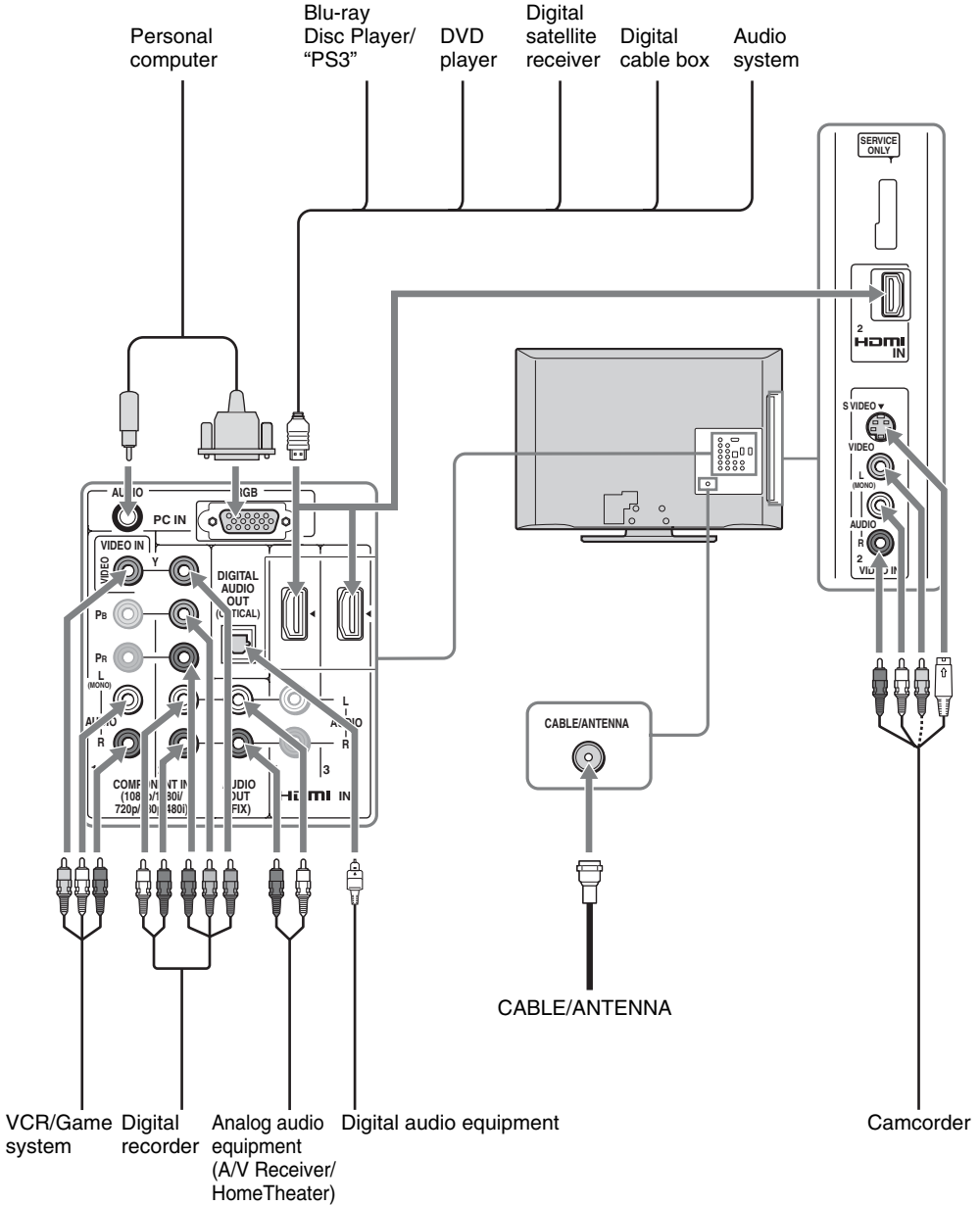

• Refer to the Quick Setup Guide (supplied) when connecting other equipment to your TV.

Bundling the Connecting Cables

Untie the AC power cord from the plastic cable band and connect the AC power cord to the nearest wall outlet when all the necessary connection is completed. Use the same plastic cable band to bundle the connecting cables as illustrated below.

Do not bundle the AC power cord with other connecting cables.

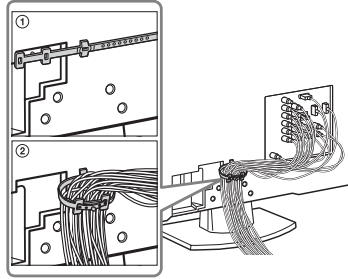

When Installing the TV Against a Wall or Enclosed Area

Make sure that your TV has adequate ventilation. Allow enough space around the TV as shown below. Avoid operating the TV at temperatures below 41 °F (5 °C).

Installed with stand

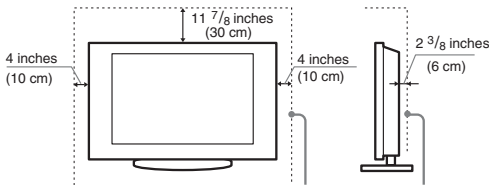

Leave at least this much space around the set.

Installed on the wall

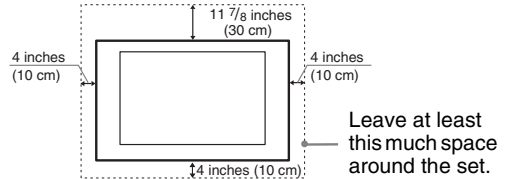

Leave at least this much space around the set.

Never install the TV set as follows:

Air circulation is blocked.

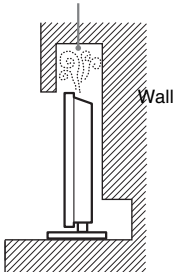

Air circulation is blocked.

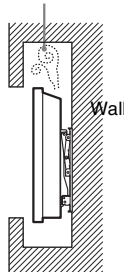

- Inadequate ventilation can lead to overheating of the TV and may cause TV damage or cause a fire.

Securing the TV



Sony strongly recommends taking measures to prevent the TV from toppling over. Unsecured TVs may topple and result in property damage, serious bodily injury or even death.

Preventing the TV from Toppling

- Secure the TV to a wall and/or stand.
- Do not allow children to play or climb on furniture and TV sets.
- Avoid placing or hanging items on the TV.
- Never install the TV on:
 - slippery, unstable and/or uneven surfaces.
 - furniture that can easily be used as steps, such as a chest of drawers.
- Install the TV where it cannot be pulled, pushed, or knocked over.
- Route all AC power cords and connecting cables so that they are not accessible to curious children.

Recommended Measures to Secure the TV

Consider the following measures when securing your TV to a TV stand (not supplied).

1 Secure the stand for the TV.

Make sure the TV stand can adequately support the weight of the TV. Use two angle braces (not supplied) to secure the stand.

For each angle brace use the appropriate hardware to:

- attach one side of the angle brace to the wall stud.
- attach the other side to the TV stand.

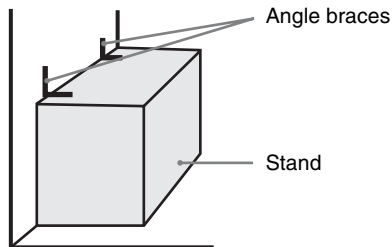

2 Secure the TV to the stand.

Use the optional hardware listed below (not supplied):

- M4 × 14 mm anchor bolt and M4 nut (screwed into the TV's Table-Top Stand).
- A screw or similar (attach it to the TV stand).
- Rope or chain (strong enough to support the weight of the TV). Make sure that there is no excess slack in the rope or chain.

An alternative way to secure the TV is with an optional Sony Support Belt Kit.

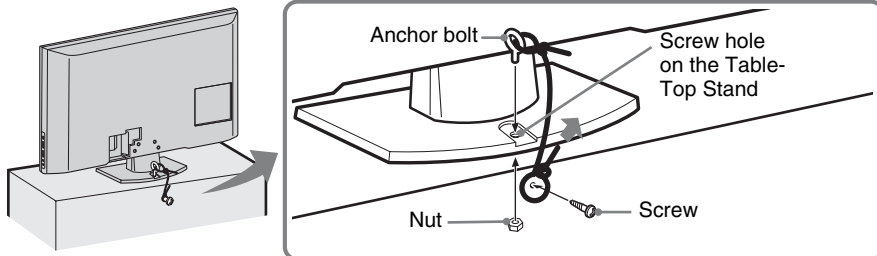

3 Anchor the TV to the wall.

Use the hardware listed below (not supplied).

- Two anchor bolts, size M4 × 10-12 mm (model KDL-26L5000) or M6 × 10-12 mm (model KDL-32L5000). Screw the bolts into the top-most wall-mount holes located on the rear of the TV.
- Rope or chain (attach to one anchor bolt).
- Wall-anchor (attach to the wall stud) strong enough to support the weight of the TV (pass the rope through the wall-anchor, then attach to the other anchor bolt).

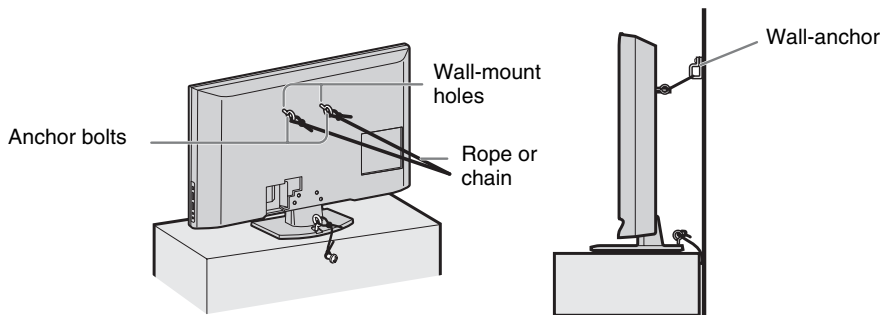

- Contact Sony Customer Support to obtain the optional Support Belt Kit by providing your TV model name.

For United States call: 1-800-488-7669 or visit: www.sony.com/accessories

For Canada call: 1-877-899-7669

- Measure 2 provides minimal protection against the TV toppling over. For further protection, follow all three measures recommended above.
- If an electric screwdriver is used, set the torque to tighten at approximately 1.5 N·m {15 kgf·cm}.

Running Initial Setup

During initial setup, you will perform the following:

- Set the language for the On Screen Display (OSD) text
- Choose your viewing environment
- Signal source connection check
- Scan for digital and analog channels

Complete your cable connections before beginning the **Initial Setup**. Refer to the Quick Setup Guide (supplied) for sample connection diagrams.

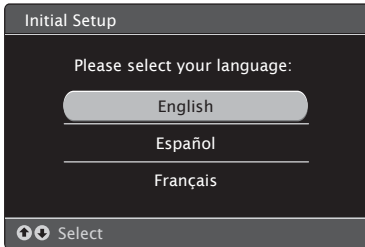

- 1 Turn on the TV. The **Initial Setup** screen will appear.
- 2 Use the remote control buttons described below to navigate through the **Initial Setup**.

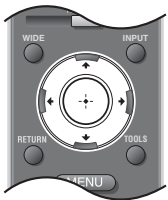

↑/↓/←/→ buttons:

Allow you to navigate and highlight options where applicable.

+ button:

Allows you to select the highlighted option and advance to the next screen.

- 3 **Auto Program** will scan for available channels from the signal source directly connected to the TV's CABLE/ANTENNA input. Follow the help text provided on the screen to run the **Auto Program**.



- When prompted to select **Retail** or **Home**, be sure to select **Home** for ENERGY STAR compliant mode.
- Select **Cancel** to stop or cancel the **Auto Program**. The **Auto Program** can be done at later time. To run **Auto Program** at later time, press **MENU** and select the **Auto Program** under **Channel** settings.
- Connect either your cable or antenna to the TV (you can connect both using an A-B RF switch (not supplied); for more details see page 9.
- Select your preferred aspect ratio for the screen display. Press **WIDE** to select the **Wide Mode** or press **MENU** and set the **Auto Wide** to **On** under the **Screen** settings; for more details, see page 23.

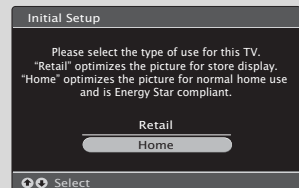

Operating the TV

Using the Remote Control

To Insert Batteries into the Remote Control

Insert two size AA batteries (supplied) by matching **+** and **-** on the batteries to the diagram inside the battery compartment of the remote control.

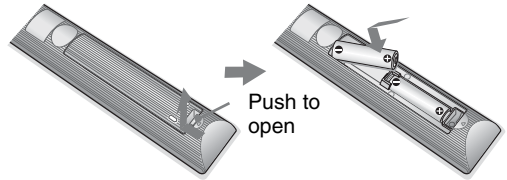

Guidelines to follow

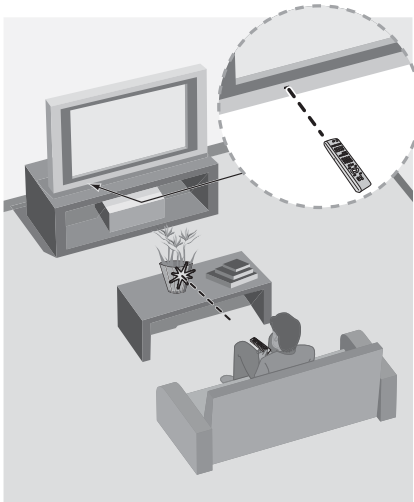

- Point your remote control directly at the IR sensor located on your TV.
- Make sure that no objects are blocking the path between the remote control and the IR sensor on your TV.
- Fluorescent lamps can interfere with your remote control; try turning off the fluorescent lamps.
- If you are having problems with the remote control, reinsert or replace your batteries and make sure that they are correctly inserted.

Remote Control Button Description

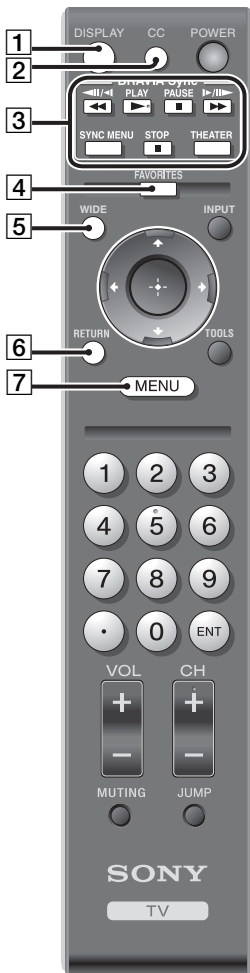







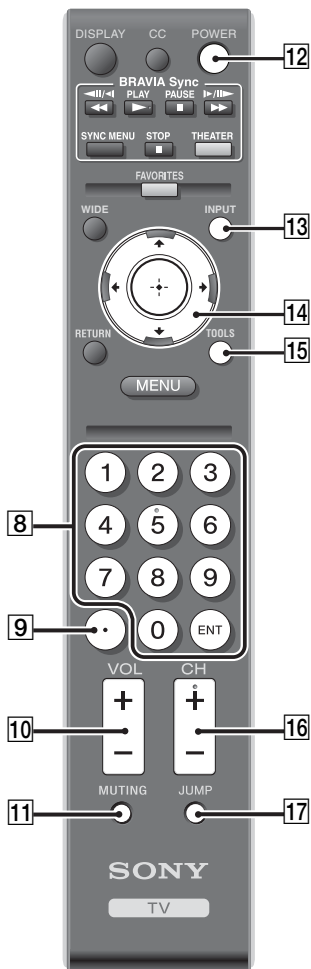



Button	Description
1 DISPLAY	Press once to display the banner with channel/program information you are watching. The banner will time out in a few seconds or press again to exit.
2 CC	Press to turn On , turn On when Muting or Off the Closed Captions (CC) .
3 BRAVIA Sync	<p>These buttons are used to control the equipment connected to the TV by using the Control for HDMI function (not available on all Control for HDMI equipment). Some other buttons on the remote control may also operate BRAVIA Sync equipment.</p> <p>◀◀ (fast reverse): Press to play a program in fast rewind mode.</p> <p>▶ PLAY: Press to play a program at a normal speed.</p> <p>⏸ PAUSE: Press to pause playback.</p> <p>▶▶ (fast forward): Press to play a program in fast forward mode.</p> <p>SYNC MENU: Press once to display the Sync'd HDMI Devices (while a Control for HDMI device is not selected). Select the HDMI device and then press SYNC MENU to display the menu of connected equipment (not available on all Control for HDMI equipment).</p> <p>■ STOP: Press to stop playback.</p> <p>THEATER: Press to turn on and off the Theater Mode. The picture settings will be set for a cinema-like experience and the audio will be switched to the audio output of the attached speakers of your BRAVIA Sync audio system. Your BRAVIA Sync audio system must be connected by an HDMI connection to your TV (see page 21 for details).</p>
4 FAVORITES	Press once to display the stored Favorites list. You can store up to 10 channels and/or external inputs in your Favorites list.
5 WIDE	Press repeatedly to cycle through the available Wide Mode settings. See page 23.
6 RETURN	Press to go back to the previous screen or exit from the screen when displaying menu items and settings.
7 MENU	Press to display the menu with TV functions and settings. See "Using the Menus" on page 25.



- The **5**, **PLAY** and **CH +** buttons have a tactile dot. Use them as a reference when operating the TV.



Button	Description
8 0-9 ENT	Press 0-9 to select a channel; the channel changes after two seconds. Press ENT to change channels immediately.
9 	Use with 0-9 and ENT to select digital channels. For example, to enter 2.1, press  ,  ,  and ENT .
10 VOL +/-	Press to adjust the volume.
11 MUTING	Press to mute the sound. Press again or press VOL + to restore the sound.
12 POWER	Press to turn on and off the TV.
13 INPUT	Press to display the list of External Inputs and TV mode. Press repeatedly to toggle through the inputs. See page 24.
14 	Press  ,  ,  ,  to move focus/highlight. Press  to select/confirm an item.
15 TOOLS	Press to display a list of convenient functions and menu shortcuts. The TOOLS menu items vary based on current input and content.
16 CH +/-	Press to scan through channels. To scan quickly through channels, press and hold down either CH +/- .
17 JUMP	Press to jump back and forth between two channels. The TV alternates between the current channel and the last channel that was selected.



TV Controls and Indicators

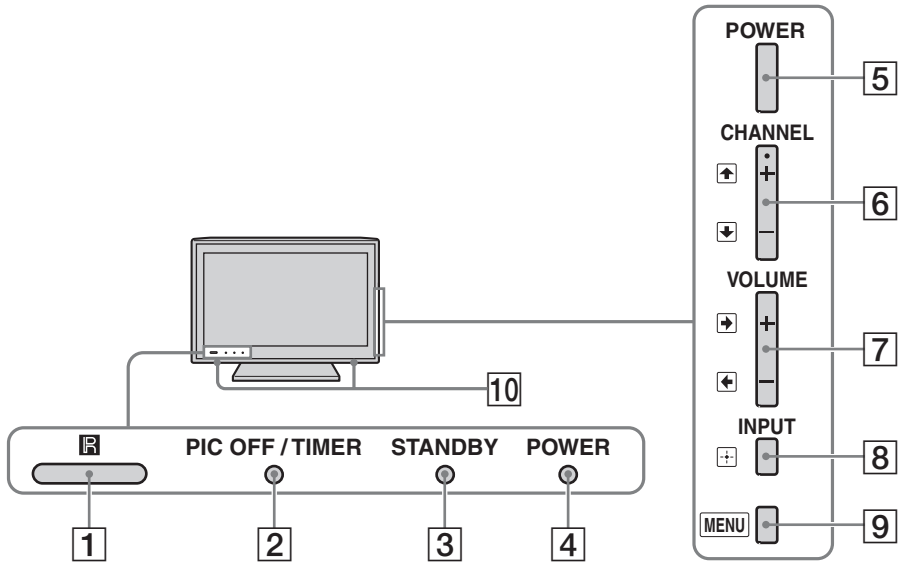

Item	Description
1 (IR) Infrared Receiver	Receives IR signal from the remote control.
2 PIC OFF/TIMER LED	Lights up in orange when the sleep timer is set. Lights up in green when the Power Saving is set to Picture Off .
3 STANDBY LED	Lights up in red when your TV is in PC power saving mode.
4 POWER LED	Lights up in green when the TV is turned on.
5 POWER	Press to turn on and off the TV.
6 - CHANNEL +	Press to scan through channels. To scan quickly through channels, press and hold down either CH -/+ . In the menu screen, these buttons serve as up/down buttons.
7 - VOLUME +	Press to adjust the volume. In the menu screen, these buttons serve as left/right buttons.
8 INPUT	Press to display the list of external inputs. Press repeatedly to toggle through the inputs. In the menu screen, this button serves as confirming the selection or setting.
9 MENU	Press to display menu with TV functions and settings (see "Using the Menus" on page 25).
10 Speaker	Outputs audio signal.



- Inputs can be changed by pressing **▲/▼** and **+** while the list of external inputs menu is displayed.
- For more information about setting up the external inputs labels and the **Skip** feature, see page 35.
- The CHANNEL + button has a tactile dot. Use it as a reference when operating the TV.
- Make sure that the TV is completely switched off before unplugging the power cord.

Using Features

Using BRAVIA Sync with Control for HDMI

The BRAVIA Sync function allows this TV to communicate with other Sony equipment supporting the **Control for HDMI** function.

To connect Sony equipment with Control for HDMI

Use an HDMI cable that bears the HDMI logo for connection. See the HDMI connection shown in the Quick Setup Guide provided with the TV documentation.

Setting the Control for HDMI

The **Control for HDMI** function must be set up in order for the TV to communicate with other **Control for HDMI** enabled equipment. See page 36 for information on how to set up this TV's **Control for HDMI** function. For other equipment, refer to its operating instructions.

Available options using Control for HDMI

The following operations are available after you connect the supported Sony equipment with **Control for HDMI** function to your TV:

- Automatically turn off the connected equipment when you turn off the TV.
- The TV will automatically turn on with the respective HDMI input.
- The connected equipment is turned on by One-Touch-Play.
- Possible operations with **BRAVIA Sync** buttons, see page 18.

When a Sony A/V receiver with BRAVIA Sync is connected, the following additional operations are possible:

- Turning on the A/V receiver when the TV is turned on.
- Automatically switching to the audio output of the A/V receiver's attached speakers.
- Adjusting the volume and muting of the A/V receiver with the TV's remote control.

Using PIP Feature

You can watch TV while working on your PC. **PIP** (picture in picture) provides PC input signal and TV channels. The CABLE/ANTENNA input must be connected to use this feature. (**Closed Captions (CC)** is not available with **PIP** mode.)



To Enter PIP

PIP Supported Inputs	
In main window	In sub window
PC	TV channel (CABLE/ANTENNA)
HDMI IN 1/2/3 (PC timing)	

- 1 Press **TOOLS** while in the PC mode.
- 2 Select **PIP** from the **TOOLS** menu.
- 3 The sub window will appear with last viewed TV channel and automatically switches to TV audio.

To Change Channels

You can change the channel of the sub window by pressing **CH +/-**, entering the channel number using the **0-9** numeric buttons, or pressing **JUMP** to switch to the previously viewed channel.

To Exit from PIP

- 1 Press **TOOLS**.
- 2 Press **▲/▼** to highlight **Exit PIP** and press **+** to exit to full PC screen.

Favorites

Your favorite channels and external inputs can be easily accessed by pressing the **FAVORITES** button once they are added to the list.

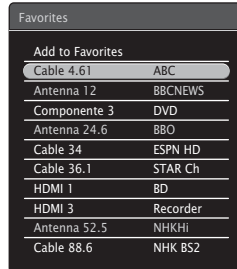

Adding to Favorites

While tuned to the channel you want to watch or viewing connected equipment, press **FAVORITES** to display the list. Highlight **Add to Favorites**, then press **+**. Your newly added item will be listed at the top of the list. When you continue to add items beyond the 10th item, the item listed at the bottom of the list will be automatically removed from the list.



- Your **Favorites** list will be cleared each time you run the **Auto Program**.

Wide Mode

The **Wide Mode** feature allows you to select the screen display to your preference. Based on the original signal source, you may see black bars around the picture or just on the both sides of the screen. Sometimes you will see the picture fill the full screen. This is due to the signals your TV receives.







You can manually select available **Wide Mode** settings as you watch your TV by pressing the **WIDE** button on your remote control or you can set your TV to **Auto Wide**.

To set Auto Wide

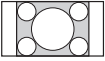
Press **MENU** then go to the **Screen** settings. Select **Auto Wide** and set to **On**.

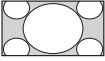
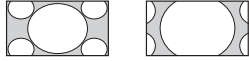
To change the Wide Screen Mode

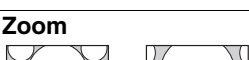
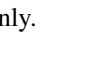
Press **WIDE** repeatedly to cycle through the available modes.

4:3 Original source	16:9 Original source
Standard-definition source 	High-definition source 
Wide Zoom 	Wide Zoom 
Normal 	Normal This mode is not available.
Full 	Full 
Zoom 	Zoom 

Normal is available with 480i or 480p sources only.



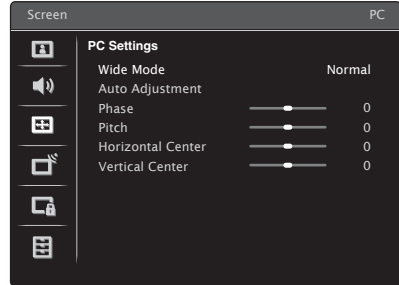

Wide Mode with PC

Wide Mode is also available for the **PC** settings. When a PC is connected to the TV and **PC** input is selected, you can change the **PC Screen** settings.



To change the Wide Screen Mode for PC Timing

Press **WIDE** repeatedly to cycle through the available modes while in the **PC** input mode.

Incoming PC signal
 800 × 600
Normal 
Full 1 
Full 2 



- Use the **Auto Adjustment** to adjust the display position and phase of the picture when the TV receives an input signal from the connected PC.
- Change the screen mode to accommodate for the display of the main window in **PIP** feature.

Inputs

Press **INPUT** to display the **Input** menu and toggle through the **External Inputs** to select your video signal for viewing including the TV mode. The inputs list consists of TV mode and other equipment connected to the TV.

You can label your **External Inputs** to identify them easily.

To Label an Input

- 1** Press **MENU** then go to **Setup** settings. Select the **Label Video Inputs** option. Press **▲/▼** to highlight the video input (**Video 1-2, Component 1-2, HDMI 1-3, PC**) to which you want to assign a label; press **⊕** to select the input of your choice.
- 2** Press **▲/▼** to highlight one of the displayed labels that corresponds to your connected equipment, then press **⊕**.
- 3** If you have an open input where no equipment is connected, you can label it as **Skip**. When you assign **Skip**, your TV will skip over this input when you press the **INPUT** button. The **Skip** labeled input is grayed out in the input list.

Using the Menus

The **MENU** button allows you to access a variety of TV settings for you to customize the settings.

Navigating through TV Menus

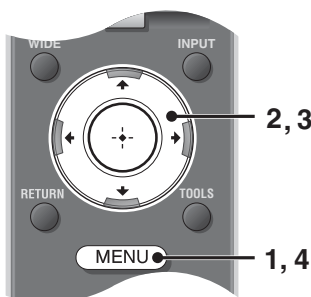

- 1 Press **MENU** on the remote control to display the menu options.
- 2 Press **↑/↓/←/→** to navigate on the menu or adjust the settings.
- 3 Press **+** to select or confirm.
- 4 Press **MENU** to exit.



Picture Settings:

Adjust the picture on your TV to fit your viewing preference.



Sound Settings:

Customize your sound settings to suit your audio preference. You can also change the settings to output the sound to your connected audio equipment.



Screen Settings:

Adjust the size and shape of the images you see on the screen.



Channel Settings:

Navigate your favorite channels and inputs and select the signal type, as well as autoprogram channels. You can also customize the channels you see and the labels assigned to them.



Parental Lock Settings:

Set the password and limit access to programming based on rating levels. You can also block channels and inputs.



Setup Settings:

Modify and customize a variety of general setting options.

Using the Picture Settings

<i>Option</i>	<i>Description</i>	
Picture Mode	Vivid	Select for enhanced picture contrast and sharpness.
<i>Customized picture viewing</i>	Standard	Select for standard picture settings. Recommended for home entertainment.
	Cinema	Select for viewing film-based content. Most suitable for viewing in a theater-like environment.
Reset	Resets the current Picture Mode settings to the default values.	
Backlight	Adjust to brighten or darken the backlight.	
Picture	Adjust to increase or decrease picture contrast.	
Brightness	Adjust to brighten or darken the picture.	
Color	Adjust to increase or decrease color intensity.	
Hue	Adjust to increase or decrease the green tones.	
Color Temperature <i>White adjustment</i>	Cool	Select to give the white colors a bluish tint.
	Neutral	Select to give the white colors a neutral tint.
	Warm	Select to give the white colors a reddish tint.
Sharpness	Adjust to sharpen or soften the picture.	
Noise Reduction	Select to reduce the picture noise level. Select from High, Medium, Low and Off .	
Advanced Settings	Reset	Resets all the advanced settings to the default values.
	Black Corrector	Enhances black areas of the picture for stronger contrast. Select from High, Medium, Low and Off .
	White Balance	Adjusts the color temperature in detail.
	CineMotion	Select Auto to activate CineMotion to automatically detect film-based content and apply an inverse 3-2 pull-down process to improve film content. Select Off to disable the function.



- You can also access **Picture Mode** by using the **TOOLS** button.
- **Advanced Settings** is not available when the **Picture Mode** is set to **Vivid**.

Using the Sound Settings

<i>Option</i>	<i>Description</i>	
Sound Mode <i>Customized sound listening</i>	Dynamic	Enhances treble and bass.
	Standard	Standard sound optimized for home use.
	Clear Voice	Suitable for spoken dialog.
Reset	Resets the current Sound Mode settings to the default values.	
Treble	Adjust to increase or decrease higher-pitched sounds.	
Bass	Adjust to increase or decrease lower-pitched sounds.	
Balance	Adjust to emphasize left or right speaker balance.	
Steady Sound	Select On to stabilize the volume across all programs and commercials. Select Off to disable this function.	
MTS Audio <i>Enjoy stereo, bilingual and mono programs</i>	Stereo	Select for stereo reception when viewing a program broadcast in stereo.
	Auto SAP	Select to automatically switch the TV to second audio programs when a signal is received. If no SAP signal is present, the TV remains in Stereo mode.
	Mono	Select for mono reception. Use to reduce noise during weak stereo broadcasts.
Alternate Audio <i>Digital channels only</i>	Select among the available options to switch among the alternate audio streams. The program you are tuned to may be broadcasted in a different language in the alternate audio streams.	
Speakers	TV Speakers	Select to use the TV speakers.
	Audio System	Select to use an external audio system for the TV sound. By selecting this option you are disabling the TV speakers.



- **MTS Audio** is only available for analog programs.
- **Alternate Audio** is not available if the program is not broadcast with alternate audio streams.
- You can also access **Sound Mode**, **MTS Audio** and **Alternate Audio** by using the **TOOLS** button on the remote control.

Using the Screen Settings

<i>Option</i>	<i>Description</i>
Wide Mode	Wide Zoom Fills the screen with minimum distortion.
	Normal Select to display 4:3 picture in original size when the original source is 4:3.
	Full Select to enlarge the picture horizontally to fill the screen when the original source is 4:3 (Standard definition source). When the original source is 16:9 (High-definition source), select this mode to display the 16:9 picture in its original size.
	Zoom Select to enlarge the original picture without distorting the aspect ratio.
Auto Wide	On Select On to automatically change Wide Mode setting based on the content.
	Off If frequent screen changes are disturbing to you, select Off . Choose a Wide Mode from the Wide Mode option when this function is selected to Off .
4:3 Default <i>Select the default Screen Mode to use for 4:3 sources</i>	Wide Zoom Enlarges the 4:3 picture to fill the 16:9 screen, displaying as much of the original image as possible.
	Normal Select to display the 4:3 picture in its original size.
	Full Select to enlarge the 4:3 picture horizontally only, to fill the display area.
	Zoom Select to enlarge the picture horizontally and vertically to an equal aspect ratio that fills the wide screen.
	Off Select to continue using the current Wide Mode setting when the channel or input is changed.
Display Area	Normal Displays the recommended picture area.
	-1/-2 Enlarges the picture to hide the edge of the picture.
Horizontal Center	Allows you to move the position of the picture left and right. (Available in Wide Zoom and Zoom .)
Vertical Center	Allows you to move the position of the picture up and down. (Available in Wide Zoom and Zoom .)



- **Normal** is not available when you are watching a 720p, 1080i or 1080p source.
- If **4:3 Default** is set to anything but **Off**, the **Wide Mode** setting changes only for the current channel. When you change channels (or inputs), **Wide Mode** is automatically replaced with the **4:3 Default** setting for 4:3 sources. To retain the current **Wide Mode** setting as channels and inputs are changed, set **4:3 Default** to **Off**.
- **4:3 Default** is not available if **Auto Wide** is set to **Off**.

<i>Option</i>	<i>Description</i>						
PC Settings	When a PC is connected to the TV and the PC input is selected, the PC settings screen appears instead of the Screen settings. You can also select the PIP feature which allows you to view two pictures simultaneously from TOOLS button (see page 22).						
Wide Mode	<table border="1"> <tbody> <tr> <td>Normal</td> <td>Select to display in the original image size.</td> </tr> <tr> <td>Full 1</td> <td>Select to enlarge the picture to fill the display area, keeping its original aspect ratio.</td> </tr> <tr> <td>Full 2</td> <td>Select to enlarge the picture to fill the display area.</td> </tr> </tbody> </table>	Normal	Select to display in the original image size.	Full 1	Select to enlarge the picture to fill the display area, keeping its original aspect ratio.	Full 2	Select to enlarge the picture to fill the display area.
Normal	Select to display in the original image size.						
Full 1	Select to enlarge the picture to fill the display area, keeping its original aspect ratio.						
Full 2	Select to enlarge the picture to fill the display area.						
Auto Adjustment	Select to automatically adjust the display position and phase of the picture when the TV receives an input signal from the connected PC. Note that Auto Adjustment may not work well with certain input signals. In such cases, manually adjust the options below.						
Phase	Adjust after Pitch to fine tune overall sharpness.						
Pitch	Adjust uneven sharpness on screen.						
Horizontal Center	Allows you to move the position of the picture left and right.						
Vertical Center	Allows you to move the position of the picture up and down.						



- For the PC Input Signal Reference Chart, see page 37.
- **Auto Adjustment**, **Phase** and **Pitch** are not available with PC signal connected to HDMI input.

Using the Channel Settings

<i>Option</i>	<i>Description</i>
Favorites	Select favorite channels and external inputs (see page 22).
Signal Type	Cable Select if you are receiving cable channels via Cable TV provider.
	Antenna Select if you are using an antenna.
Auto Program	Automatically sets up the channel list on the TV for all receivable channels.
	1 Select Auto Program . 2 Select OK to start Auto Program .
Add Digital Channels	1 Select Add Digital Channels .
	2 Select OK to add digital channels.
Show/Hide Channels	Allows you to show or hide channels that appear when you use the CH +/- buttons.
	1 Press ▲/▼ to scroll through the channels until you find the channel you want to show or hide. Then press + to select it. 2 Press ▲/▼ to determine if the channel will be shown or hidden. Then press + to select it.
Label Channels	Allows you to assign labels (such as station call letters) to channel numbers.
	1 Press ▲/▼ to scroll through the channel numbers. Then press + to select the channel number that you want to assign a label. 2 Press ▲/▼ to scroll through the label characters (A-Z, 0-9, etc.). Press ▶ to move to the next character. Repeat the previous steps to add up to seven characters to the label. When finished, press + .



- You should run **Auto Program** after changing the **Signal Type** setting.
- Running **Auto Program** will clear **Favorites** list.
- Channels that you set to be hidden can be accessed by the **0-9** and **+** buttons.
- You can set channels to be hidden that are automatically set in **Auto Program**.



Using the Parental Lock Settings

Option	Description
Enter Password	The Parental Lock settings allow you to set up the TV to block programs according to their content and rating levels. Use 0-9 on the remote control to enter a four-digit password. The first time you create a password, confirm the password by entering it again.
Change Password	Select to change your password.
Country	U.S.A. Select to use U.S.A. ratings (see page 32).
	Canada Select to use Canadian ratings (see page 33).
Rating	Off Turn Parental Lock off. No programs are blocked from viewing.
	Child Maximum ratings permitted are: U.S.: TV-Y, TV-G, G Canada: C, G, TV-Y
	Youth Maximum ratings permitted are: U.S.: TV-PG, PG Canada: C8+, PG, 8 ans+, TV-PG
	Young Adult Maximum ratings permitted are: U.S.: TV-14, PG-13 Canada: 14+, 13 ans+, TV-14
	Custom Select to set ratings manually. U.S.: See page 32 for details. Canada: See page 33 for details.
Downloadable U.S. Rating <i>(Available only in U.S.A. where advanced ratings exist)</i>	Off Turn Downloadable U.S. Rating off. No programs that contain downloadable ratings are blocked from viewing.
	Custom Select to block programs based on downloadable ratings.
	Clear All Select to clear the entire downloadable rating system.
Unrated <i>(Available only when Country is set to U.S.A.)</i>	Allow Allows programs and movies that are broadcasted without a rating.
	Block Blocks all programs and movies that are broadcasted without a rating.
Channel Block	Allows you to block channels regardless of program ratings. To View a Blocked Channel Press ENT when tuned to the blocked channel then enter the password.
External Input Block	Allows you to block external inputs regardless of program ratings. To View a Blocked External Input Press ENT when tuned to the blocked input then enter the password.



- You need your password for any future access into the **Parental Lock** settings. If you lose your password, see “Lost password” on page 42.
- Selecting **Clear All** will delete the current **Downloadable U.S. Rating** menu and the menu will no longer be available until the TV is tuned to a channel that contains downloadable ratings.
- If you block unrated TV programs, be aware that the following types of programs may be blocked: programs broadcasted from another country, emergency broadcasts, political programs, sports, news, public service announcements, religious programs and weather.

US Models: Selecting Custom Parental Lock Rating Options

To select custom rating options for the U.S., select **U.S.A.** in the **Country** setting (see page 31).

<i>Option</i>	<i>Description</i>
Movie Rating	G All children and general audience.
	PG Parental guidance suggested.
	PG-13 Parental guidance for children under 13.
	R Restricted viewing, parental guidance is suggested for children under 17.
	NC-17 and X No one 17 or under allowed.
TV Rating	Age-Based Ratings
<i>Block programs by their rating, content or both</i>	TV-Y All children.
	TV-Y7 Directed to children age 7 and older.
	TV-G General audience.
	TV-PG Parental guidance suggested.
	TV-14 Parents strongly cautioned.
	TV-MA Mature audience only.
	Content-Based Ratings
	FV Fantasy violence.
	D Suggestive dialogue.
	L Strong language.
S Sexual situations.	
V Violence.	



- To ensure maximum blocking capability, set the Age-Based Ratings.

Canadian Models: Selecting Custom Parental Lock Rating Options

To select custom rating options for Canada, select **Canada** in the **Country** setting (see page 31).

<i>Option</i>	<i>Description</i>
English Rating	C All children.
	C8+ Children 8 years and older.
	G General programming.
	PG Parental guidance.
	14+ Viewers 14 and older.
	18+ Adult programming.
French Rating	G General programming.
	8 ans+ Not recommended for young children.
	13 ans+ Not recommended for ages under 13.
	16 ans+ Not recommended for ages under 16.
18 ans+ Programming restricted to adults.	
U.S.A. Rating	See “US Models” on page 32 for details.

Viewing Blocked Programs

You can view blocked programs by entering your password. Press **ENT** when tuned to a blocked program, then enter the password. This temporarily deactivates the parental control feature. To reactivate the **Parental Lock** settings, turn off the TV. When the TV is turned on again, your **Parental Lock** settings are reactivated.



Using the Setup Settings

Option	Description	
Eco	Power Saving Select from High , Low , Off , Picture Off to adjust your TV's power consumption. By selecting the High option, you will reduce the power consumption more than the other available settings. While Picture Off is set, pressing VOL +/- or MUTING buttons will not disable this function. Press other buttons to disable it.	
	Idle TV Standby Select to automatically power off the TV after 1h , 2h , or 3h when no buttons are pressed on the remote control or the TV. Select Off to disable this function.	
	PC Power Management Select On to allow the TV to automatically enter standby mode when there is no signal input for 30 seconds. The STANDBY LED on the front panel illuminates with the On option. Select Off to disable this function. PC Power Management option is not available with PC-HDMI connection.	
Closed Captions (CC)	Allows you to select from several closed caption modes (for programs that are broadcast with closed captioning).	
	CC Display	On Closed Captions (CC) is turned on.
	On when Muting	Closed Captions (CC) is turned on when the TV is muted.
	Off	Closed Captions (CC) is turned off.
	Analog CC	Allows you to select basic analog (EIA-608) closed caption options.
	CC1, CC2, CC3, CC4	Displays a printed version of the dialogue or sound effects of a program. (Should be set to CC1 for most programs.)
	Text1, Text2, Text3, Text4	Displays network/station information presented using either half or the whole screen (if available).
	Digital CC	When the digital closed caption service is available, select from the Service 1-6 or CC1-4 .
	Digital CC Options	Allows you to make additional settings for digital closed caption options. Select As Broadcast or Custom . The Custom option is available on the Digital CC setting.
	Custom	Allows you to customize the following settings:
Character Size	Small, Standard, Large	
Character Style	Style 1-7	
Character Color	Color 1-8	
Character Opacity	Solid, Translucent	
Edge Type	None, Raised, Depressed, Outline, Left Shadow, Right Shadow	
Edge Color	Color 1-8	
Background Color	Color 1-8	
Background Opacity	Solid, Translucent	



- **PC Power Management** is not VESA-compliant.
- You can turn on **Closed Captions (CC)** options (**On**, **Off** or **On when Muting**) by directly pressing the **CC** button on the remote control.

<i>Option</i>	<i>Description</i>
Sleep Timer	Set the time in minutes (Off, 15, 30, 45, 60, 90, or 120) that you would like the TV to remain on before shutting off automatically.
Language	Select to display all on-screen settings in your language of choice: English, Español, Français.
Info Banner	Displays the information related to the input signal you are watching. Select Small to display minimal channel and program title or select Large to display detailed channel and program information along with the TV icon if you are viewing the TV. This information will appear if it is available from the broadcaster. Info Banner appears on the screen each time the channel and external inputs are changed or when DISPLAY on the remote control is pressed.
Label Video Inputs	Allows you to identify A/V equipment you connected to the TV, such as a VCR, DVD, etc. For example, if you have a DVD player connected to the COMPONENT IN jack, you can select the label DVD for the Component input. Then when you press INPUT to change inputs, the video label you assigned to that input appears on screen. 1 Press ▲/▼ to highlight the video input (Video 1-2, Component 1-2, HDMI 1-3, PC) to which you want to assign a label. Then press ⊕ to select the input. 2 Press ▲/▼ to highlight one of the displayed labels. Then press ⊕ to select the label.
Video/Component 1 Selection	Select Auto to have the TV detect and switch between the Video 1 or Component 1 when Video 1 or Component 1 is connected.



- You can assign following labels for each input (except PC IN):
–, DVD, Cable Box, Satellite, BD, VCR, Receiver, DVR, Game, Camcorder, PC, Skip
- “–” indicates that no labels are assigned.
- If you select **Skip**, your TV skips this input when you press the **INPUT** button.
- The Skip label is useful for inputs to which no equipment is connected.

<i>Option</i>	<i>Description</i>
HDMI Settings	HDMI inputs of this TV will recognize and communicate with other Sony equipment equipped with Control for HDMI function.
Control for HDMI	On/Off feature allows your TV to communicate with other equipment that supports Control for HDMI function.
Device Auto Power Off	Select On to have your connected equipment with Control for HDMI function to power off automatically when the TV is turned off. Select Off to disable this function. This feature is available when Control for HDMI is On .
TV Auto Power On	Select On to control your TV's power on from your connected equipment with Control for HDMI function. Select Off to disable this function. This feature is available when Control for HDMI is On .
Device List	Displays a list of equipment with Control for HDMI function connected to the TV. <ul style="list-style-type: none"> • Press TOOLS while the equipment supporting Control for HDMI is connected to display the Device Control options. The Device Control option provides access to the Menu, Options and Content List of your connected equipment with your TV remote control. • Some equipment with Control for HDMI does not support the Device Control feature.
Picture Adjustments Lock	Select Lock so no adjustment can be made to items grayed out. Select Unlock to allow adjustment to any of the Picture settings.
Product Support	Contact Sony Sony contact information is available on this screen for your convenience. TV specific information such as Model Name, Serial Number, Software Version and downloadable ratings (if available from the TV) are displayed here.
	Signal Diagnostics Press to display the diagnostics information for the current signal.

Other Information

PC Input Signal Reference Chart for PC and HDMI IN 1/2/3

After connecting the PC to the TV, set the output signal from the PC according to the chart below.

Resolution				Horizontal frequency (kHz)	Vertical frequency (Hz)	Standard
Signals	Horizontal (Pixel)	×	Vertical (Line)			
VGA	640	×	480	31.5	60	VGA
SVGA	800	×	600	37.9	60	VESA Guidelines
XGA	1,024	×	768	48.4	60	VESA Guidelines
WXGA	1,280	×	768	47.4	60	VESA
	1,280	×	768	47.8	60	VESA
	1,360	×	768	47.7	60	VESA



- This TV's PC input does not support Sync on Green or Composite Sync.
- This TV's PC VGA input does not support interlaced signals.
- Your PC must support one of the above PC input signals to display on the television.
- In plug and play, signals with a 60 Hz vertical frequency will be detected automatically. (PC reboot may be necessary.)

*The 1080p timing when applied to the HDMI input will be treated as a video timing and not PC timing. This affects **Picture** settings, **Wide Mode** settings, and **PIP** function.

Preparing the TV for Wall-Mounting

This TV can be installed on a wall by using a Wall-Mount Bracket (sold separately). Before mounting the TV on a wall, the Table-Top Stand must be removed from the TV.

Follow the simple steps below to remove the Table-Top Stand:

- 1 Disconnect all the cables from the TV.
- 2 Secure the Mounting Hook to the rear of the TV.
- 3 Adjust the angle of the Mounting Hook.
- 4 Start removing the screws behind the TV (See illustration). Do not remove any other screws from the TV.
- 5 When screws are removed, lift the TV off the stand. Make sure that you carry out this task with at least two people. Do not attempt to lift the TV by yourself.

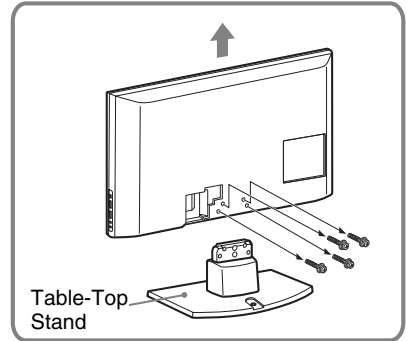

For bracket installation, refer to the instruction guide provided by the Wall-Mount Bracket model for your TV. Sufficient expertise is required in installing this TV, especially to determine the strength of the wall for withstanding the TV's weight. **For product protection and safety reasons, Sony strongly recommends that you use the Wall-Mount Bracket model designed for your TV and that the wall-mounting of your TV is performed by Sony dealers or licensed contractors.**

SU-WL100: KDL-26L5000

SU-WL500: KDL-32L5000

Be sure to use the screws supplied with the Wall-Mount Bracket when attaching the mounting hooks to the TV set. The supplied screws are designed so that they are 8 mm to 12 mm in length when measured from the attaching surface of the mounting hook. The diameter and length of the screws differ depending on the Wall-Mount Bracket model. Use of screws other than those supplied may result in internal damage to the TV set or cause it to fall, etc.

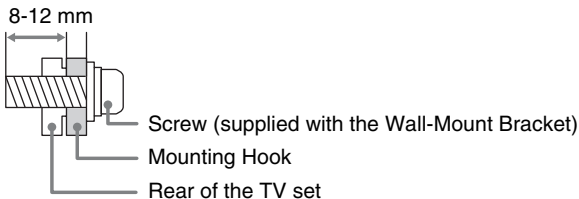

- Do not remove the Table-Top Stand for any reason other than to wall-mount the TV.
- Be sure to store the removed screws and Table-Top Stand in a safe place until you are ready to reattach the Table-Top Stand. Keep the screws away from small children.

Troubleshooting

Many of the poor pictures and poor sound conditions are related to improper connection of the cables; refer to the Quick Setup Guide provided for connections.

If you have questions, service needs, or require technical assistance related to the use of your Sony TV even after you read this operating instructions manual, contact the following:

For US Support:

<http://www.sony.com/tvsupport> or call 1-800-222-SONY (7669)

For Canadian Support:

<http://www.sony.ca/support> or call 1-877-899-SONY (7669)

Things to consider

- Check the input selection by pressing the **INPUT** button. You may be watching the wrong input.
- If you cannot hear sound from the TV, you may have accidentally pressed the **MUTING** button on your remote control; press the **MUTING** button again or press **VOL +** to deactivate muting.
- If the remote control is not functioning properly, the batteries may be installed incorrectly or may be low or an object or light may be interfering with the remote control.
- To reset the TV to factory default settings:
 - 1 Turn on the TV.
 - 2 Press and hold down the **▲** button on the remote, press the **POWER** button on the TV set. (The TV will turn itself off, then back on again.)
 - 3 Release the **▲** button when the TV is turn on.

WARNING: The factory reset will clear all of your customized settings including the **Parental Lock** setting. When the Password is lost or cannot remember, enter the master password: 4357. This password clears your previous password and allows you to enter a new password.

Condition	Explanation/Solution
No picture	
No picture	<ul style="list-style-type: none"> • Check the Power Saving settings (see page 34).
Cannot receive any channels	<ul style="list-style-type: none"> • Make sure the power cord is connected securely. • Turn on the power of the TV. • Check cable/antenna connections. • Make sure the Signal Type setting is correct for your TV signal source.
TV is locked to one channel	<ul style="list-style-type: none"> • Perform Auto Program to add receivable channels that are not present in the TV's memory (see pages 16 and 30).
Cannot receive or select channels	<ul style="list-style-type: none"> • Perform Auto Program to add receivable channels that are not present in the TV's memory (see pages 16 and 30). • To receive or select cable channels, make sure that Signal Type in the Channel settings is set to Cable (see page 30). To receive or select UHF channels over an antenna, make sure Signal Type is set to Antenna.
The TV turns off automatically	<ul style="list-style-type: none"> • Check if Sleep Timer is activated (see page 35). • Check PC Power Management in the Eco settings (see page 34). • Check Idle TV Standby in the Eco settings.
No picture from some video sources	<ul style="list-style-type: none"> • Check the connection between the optional video equipment and the TV. • Press INPUT on the remote control (see page 24).

Condition	Explanation/Solution
Poor picture	
Picture quality not as good as viewed at the store	<ul style="list-style-type: none"> Picture quality depends on the signal content. See Quick Setup Guide (supplied) to display the best possible picture for that signal.
Broadcast HD formats have poor quality	<ul style="list-style-type: none"> Content and signal quality are regulated by the signal provider. Many HD channels and content are actually upscaled versions of standard-definition broadcasts. The picture is affected by the quality of the signal received, which varies between channel and program.
Double images or ghosts	<ul style="list-style-type: none"> Check cable/antenna connections. Check the antenna location and direction.
Only snow and noise appear on the screen	<ul style="list-style-type: none"> Check if the antenna is broken or bent. Check if the antenna has reached the end of its serviceable life. (3-5 years in normal use, 1-2 years at the seaside.)
Dotted lines or stripes	<ul style="list-style-type: none"> Keep the TV away from noise sources such as cars, motorcycles, or hair-dryers. If using 300 ohm twin lead, move the excess lead away from the TV or try using 75 ohm coaxial cable instead.
No color / Dark picture / Color is not correct / The picture is too bright	<ul style="list-style-type: none"> Adjust the Picture Mode options in the Picture settings (see page 26). If you set the Power Saving mode to Low or High, it will enhance the black level.
Noisy picture	<ul style="list-style-type: none"> Make sure that the antenna is connected using a 75-ohm coaxial cable (not supplied). Keep the antenna cable away from other connecting cords. To avoid TV interference, make sure to use an undamaged antenna cable.
Blurry picture / Poor color	<ul style="list-style-type: none"> Transporting the TV from a cold to a warm location or a sudden change in room temperature may cause moisture condensation, resulting in a blurry picture or poor color. Turn off your TV and wait a few hours before powering on again.
No sound / Noisy sound	
No sound but good picture	<ul style="list-style-type: none"> Check the volume control. Press MUTING or VOL + so that "Muting" disappears from the screen (page 19). Set Speakers to TV Speakers in the Sound settings (see page 27). If it is set to Audio System, sound is not output from the TV's speakers regardless of the TV's volume control. When using HDMI input with Super Audio CD or DVD-Audio, DIGITAL AUDIO OUT (Optical) may not provide an audio signal. When tuned to a digital channel with Alternate Audio, the broadcaster may not be broadcasting your preferred Alternate Audio language. Press TOOLS, highlight and select Alternate Audio, and change the Alternate Audio language (see page 27).
Audio noise	<ul style="list-style-type: none"> Make sure that the antenna is connected using a 75-ohm coaxial cable (not supplied). Keep the antenna cable away from other connecting cords. To avoid TV interference, make sure to use an undamaged antenna cable.
No audio or low audio with Home Theater System	<ul style="list-style-type: none"> Press THEATER for BRAVIA Sync activated Theater System (see page 21). Set Speakers to Audio System in the Sound settings (see page 27).
No color / Irregular picture	<ul style="list-style-type: none"> Verify that the Video/Component 1 Selection (page 35) is set to the current input type in use. We suggest leaving this setting to Auto.

Condition	Explanation/Solution
BRAVIA Sync	
Cannot find connected BRAVIA Sync HDMI device	<ul style="list-style-type: none"> Make sure that the Control for HDMI is set up on both the TV and the optional device compatible with BRAVIA Sync (see page 21).
Second A/V receiver is not listed on the Device List	<ul style="list-style-type: none"> Only one A/V receiver may be used with the BRAVIA Sync and Control for HDMI functions at one time (see page 36).
PC Input	
No picture / No signal	<ul style="list-style-type: none"> Confirm the PC is correctly connected to the TV with either the PC IN (with an HD15 cable) or with the HDMI IN. Ensure the output signal from the PC is one of the formats listed on page 37. Turn the PC off. Confirm the PC connection and restart the PC. Plug-and-play will auto-detect the TV and correctly set up PC timing. Verify PC Power Management is activated (see page 34). Verify the PC is not in standby or hibernation mode.
Poor Picture	<ul style="list-style-type: none"> Adjust the resolution (see page 37). Adjust Pitch and Phase.
General	
TV screen feels warm	<ul style="list-style-type: none"> Due to the thin profile of this television, the heat generated by the LCD panel backlight and supporting electronics will be more noticeable. This is normal operation and not a cause for concern.
Wide Mode changes automatically	<ul style="list-style-type: none"> The current Wide Mode setting is automatically replaced with the 4:3 Default setting when you change the channel or video input, if 4:3 Default in the Screen settings is set to other than Off. If you want to lock in Wide Mode selected with WIDE on the remote control, set 4:3 Default to Off in the Screen settings (see page 28). Check the Auto Wide option in the Screen settings (see page 28).
Suddenly the picture gets smaller	<ul style="list-style-type: none"> The picture gets smaller during the commercials due to the method in which the provider broadcasts their content. When HD content channels switch to SD content (commercials), the picture may be small with a black border. Auto Wide will not expand the picture during these content changes since the content information is regulated by the channel signal provider. You can manually change the Wide Mode if you prefer (see page 23). This setting will remain in effect until you change the channel or input or manually change the Wide Mode again.
“Black box” on screen	<ul style="list-style-type: none"> You have selected a text option and no text is available (see page 34). To turn off this feature, set the CC Display option to Off. If you were trying to select closed captioning, select CC1 instead of Text1-4.

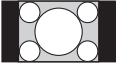

Condition	Explanation/Solution
Black bands appear at the edges of the screen	 <ul style="list-style-type: none"> • Some wide screen programs are filmed in aspect ratios that are greater than 16:9 (this is especially common with theatrical releases). Your TV will show these programs with black bands at the top and bottom of the screen. For more details, check the documentation that came with your DVD/Blu-ray (or contact your program provider). • Programs in 4:3 aspect ratio will have bands on left and right sides of the screen. • Programs broadcast in HD formats (720p and 1080i) with 4:3 content will commonly have black bands on the left and right sides of the screen which are added by the broadcaster (see image on left). • Auto Wide will not expand the picture when the black bands on the sides of the screen are added by the broadcaster. You can manually change the Wide Mode to Wide Zoom, or Zoom to fill the screen, which will remain in affect until you change the channel or input or manually change the Wide Mode again.
Certain programs on DVD or other digital sources display a loss of detail, especially during fast-motion or dark scenes	<ul style="list-style-type: none"> • This is due to the digital compression of the source content used by certain digital broadcasts and DVDs which may cause your TV's screen to display less detail than usual, or cause artifacts (small blocks or dots, pixelations) to appear on your screen. These signal compressions are more visible and are dependent on the clarity and resolution of the TV.
Remote control does not operate	<ul style="list-style-type: none"> • To determine if the problem is with the remote control or not, press a button on the TV. • Check the polarity of the batteries or replace the batteries. • Point the remote control at the remote control sensor located at the front of the TV. • Keep the remote control sensor area clear from obstacles. • Fluorescent lamps can interfere with your remote control operation; try turning off the fluorescent lamps.
Some digital cable channels are not being displayed	<ul style="list-style-type: none"> • Certain cable companies have limitations on the broadcast of digital cable channels. Check with your cable company for more information. • The digital cable channel may be set to Hidden in the Show/Hide Channels setting (see page 30).
Lost password	<ul style="list-style-type: none"> • Select the Password settings on the Parental Lock settings, then enter the following master password: 4357. This password clears your previous password and allows you to enter a new password (see page 31).
How to reset the TV to factory settings	<ul style="list-style-type: none"> • Turn on the TV. While holding down ▲ on the remote control, press POWER on the TV. (The TV will turn itself off, then back on again.) Release ▲. <p>WARNING: The reset will clear all of your customized settings including the Parental Lock setting.</p>

Important Notices

Declaration of Conformity

Trade Name: SONY
Model: KDL-26L5000/KDL-32L5000
Responsible Party: Sony Electronics Inc.
Address: 16530 Via Esprillo,
San Diego, CA 92127 U.S.A.
Telephone Number: 858-942-2230

This device complies with part 15 of the FCC rules. Operation is subject to the following two conditions: (1) This device may not cause harmful interference, and (2) this device must accept any interference received, including interference that may cause undesired operation.

For customers in Canada

This Class B digital apparatus complies with Canadian ICES-003.

FCC Related Information

This equipment has been tested and found to comply with the limits for a Class B digital device, pursuant to Part 15 of the FCC Rules. These limits are designed to provide reasonable protection against harmful interference in a residential installation. This equipment generates, uses and can radiate radio frequency energy and, if not installed and used in accordance with the instructions, may cause harmful interference to radio communications. However, there is no guarantee that interference will not occur in a particular installation. If this equipment does cause harmful interference to radio or television reception, which can be determined by turning the equipment off and on, the user is encouraged to try to correct the interference by one or more of the following measures:

- Reorient or relocate the receiving antenna.
- Increase the separation between the equipment and receiver.
- Connect the equipment into an outlet on a circuit different from that to which the receiver is connected.
- Consult the dealer or an experienced radio/TV technician for help.

Pursuant to FCC regulations, you are cautioned that any changes or modifications not expressly approved in this manual could void your authority to operate this equipment.

The shielded interface cable recommended in this manual must be used with this equipment in order to comply with the limits for a digital device pursuant to Subpart B of Part 15 of FCC Rules.

Note

This television includes a QAM demodulator which should allow you to receive unscrambled digital cable television programming via subscription service to a cable service provider. Availability of digital cable television programming in your area depends on the type of programming and signal provided by your cable service provider.

For Customers in the United States

The lamp in this product contains mercury. Disposal of these materials may be regulated due to environmental considerations. For disposal or recycling information, please contact your local authorities or the Electronic Industries Alliance (www.eiae.org).

To Customers

Sufficient expertise is required for TV installations. Be sure to subcontract the installation to a Sony dealer or licensed contractor and pay adequate attention to safety during the installation.

Specifications

Model	KDL-26L5000	KDL-32L5000
System		
Television system	NTSC: American TV standard ATSC (8VSB terrestrial): ATSC compliant 8VSB QAM on cable: ANSI/SCTE 07 2000 (Does not include CableCARD functionality)	
Channel coverage	Analog terrestrial: 2 - 69 / Digital terrestrial: 2 - 69 Analog Cable: 1 - 135 / Digital Cable: 1 - 135	
Panel system	LCD (Liquid Crystal Display) Panel	
Speaker output	8 W + 8 W	10 W + 10 W
Input/Output jacks		
CABLE/ANTENNA	75-ohm external terminal for RF inputs	
VIDEO IN 1/2	S VIDEO (4-pin mini DIN) (VIDEO 2 only): Y: 1.0 Vp-p, 75 ohms unbalanced, sync negative / C: 0.286 Vp-p (Burst signal), 75 ohms VIDEO: 1 Vp-p, 75 ohms unbalanced, sync negative AUDIO: 500 mVrms (Typical) / Impedance: 47 kilohms	
COMPONENT IN 1/2	YPbPr (Component Video): Y: 1.0 Vp-p, 75 ohms unbalanced, sync negative / Pb: 0.7 Vp-p, 75 ohms Pr: 0.7 Vp-p, 75 ohms / Signal format: 480i, 480p, 720p, 1080i, 1080p AUDIO: 500 mVrms (Typical) / Impedance: 47 kilohms	
HDMI IN 1/2/3	HDMI: Video: 480i, 480p, 720p, 1080i, 1080p, 1080/24p Audio: Two channel linear PCM 32, 44.1 and 48 kHz, 16, 20 and 24bits, Dolby Digital AUDIO (HDMI IN 1 only): 500 mVrms (Typical) / Impedance: 47 kilohms PC Input (see page 37)	
AUDIO OUT	500 mVrms (typical)	
DIGITAL AUDIO OUT (OPTICAL)	PCM/Dolby Digital optical signal	
PC IN	D-sub 15-pin, analog RGB, 0.7 Vp-p, 75 ohms, positive See the PC Input Signal Reference Chart for PC and HDMI IN 1/2/3 on page 37.	
PC AUDIO INPUT	Stereo mini jack, 500 mVrms, (Typical) / Impedance: 47 kilohms	
Power and others		
Power requirement	120-240 V AC, 50/60 Hz	
Power consumption in use	75 W	135 W
Power consumption in standby	All models less than 0.5 W	
Screen size (inches measured diagonally)	26	31.5 (32 class)
Display resolution	1,366 dots (horizontal) × 768 lines (vertical)	
Speaker/Full range (2) (mm) (inches)	40 × 100 1 5/8 × 4	34 × 160 1 3/8 × 6 1/3
Dimensions with stand (mm) (inches)	679 × 485 × 222 26 3/4 × 19 1/8 × 8 3/4	807 × 557 × 222 31 7/8 × 22 × 8 3/4
Dimensions without stand (mm) (inches)	679 × 435 × 93 26 3/4 × 17 1/4 × 3 3/4	807 × 508 × 94 31 7/8 × 20 × 3 3/4
wall-mount hole pattern (mm)	200 × 100	
wall-mount screw size (mm)	M4 (length: refer to diagram on page 38)	M6 (length: refer to diagram on page 38)
Mass with stand (kg) (lb.)	10.0 22.1	12.7 28.0
Mass without stand (kg) (lb.)	8.7 19.3	11.4 25.3
Supplied accessories	Remote control RM-YD028 (1) / Size AA batteries (2) / Operating Instructions (1) / Quick Setup Guide (1) / Warranty Card (1) / Safety and Regulatory Booklet (1) / Attaching the Table-Top Stand (1) / Screws (4)	
Optional accessories	Connecting cables / Support Belt Kit / Wall-Mount Bracket: see page 2	

- Optional accessories availability depends on its stock.
- Design and specifications are subject to change without notice.

Index

0-9 buttons 19
4:3 Default 28

A

AC power cord 8
Add Digital Channels 30
Advanced Settings 26
Alternate Audio 27
AUDIO OUT jack, described 8
Auto Adjustment 29
Auto Program 16, 30
Auto Wide 28

B

Backlight 26
Balance 27
Bass 27
BRAVIA Sync buttons 18
Brightness 26

C

CABLE/ANTENNA input, described 8
CC button 18
CH +/- button 19, 20
Change Password 31
Channel Block 31
CineMotion 26
Closed Captions (CC) 34
Color 26
Color Temperature 26
COMPONENT IN (1080p/1080i/720p/480p/480i) 8
Country 31

D

DIGITAL AUDIO OUT OPTICAL 7
Display Area 28
DISPLAY button 18
Downloadable U.S. Rating 31

E

Eco 34
English Rating 33
ENT button 19
Enter Password 31
External Input Block 31

F

Favorites 30
FAVORITES button 18
French Rating 33

H

HDMI IN jack, described 7
HDMI Settings 36
Horizontal Center 28, 29
Hue 26

I

Info Banner 35
Infrared Receiver (IR) 20

INPUT button 19, 20
Installing the TV on a wall 38

J

JUMP button 19

L

Label Channels 30
Language 35

M

MENU button 18, 20
Movie Rating 32
MTS Audio 27
MUTING button 19

N

Noise Reduction 26

P

PC IN 7
PC Settings 29
Phase 29
PIC OFF/TIMER 20
Picture 26
Picture Adjustments Lock 36
Picture Mode 26
PIP 22
Pitch 29
POWER button 19, 20
POWER LED 20
Product Support 36

R

Rating 31
Reset 26, 27, 42
RETURN button 18

S

SERVICE 7
Settings
 Channel 30
 Parental Lock 31
 Picture 26
 Screen 28
 Setup 34
 Sound 27
Sharpness 26
Show/Hide Channels 30
Sleep Timer 35
Sound Mode 27
Speaker 27
STANDBY LED 20
Steady Sound 27

T

TOOLS 19
Treble 27
Troubleshooting 39–42
TV Rating 32

U

U.S.A. Rating **33**

Unrated **31**

V

Vertical Center **28, 29**

VIDEO/AUDIO (L/R) jacks, described **7, 8**

Video/Component 1 Selection **35**

Viewing Blocked Programs **33**

VOL +/- button **19, 20**

W

WIDE button **18**

Wide Mode **28, 29**

On-line Registration Available

Be sure to register your TV.

United States

<http://productregistration.sony.com>

Canada

<http://www.SonyStyle.ca/registration>

<http://www.sony.net/>

Printed in China

4-132-223-11(1)



46.71114.001