

## For Your Convenience

### Online Registration:

Be sure to register your TV.

**United States** <http://productregistration.sony.com>

**Canada** <http://www.SonyStyle.ca/registration>

# SONY®

4-175-274-11(1)

## LCD Digital Color TV

### Operating Instructions

Introducing Your New BRAVIA®

Getting Started

Operating the TV

Using Features

Using the Menus

Other Information

### Sony Customer Support

U.S.A.: [www.sony.com/tvsupport](http://www.sony.com/tvsupport)

Canada: [www.sony.ca/support](http://www.sony.ca/support)

United States

Canada

1.800.222.SONY

1.877.899.SONY

Please Do Not Return  
the Product to the Store

# BRAVIA

<http://www.sony.net/>

© 2010 Sony Corporation Printed in Mexico



KDL-60EX500 / 55EX500 / 55EX501 / 46EX400 / 46EX401 / 46EX500 / 46EX501  
KDL-40EX400 / 40EX401 / 40EX500 / 40EX501 / 32EX301 / 32EX400 / 32EX500  
KDL-32FA600

## Owner's Record

The model and serial numbers are located at the side and rear of the TV. Record these numbers in the spaces provided below. Refer to them whenever you call upon your Sony dealer regarding this TV.

Model Name

---

Serial No.

---

Your BRAVIA TV is ENERGY STAR® qualified in the "Home" mode. It meets strict energy efficiency guidelines set by the U.S. Environmental Protection Agency and Department of Energy.



ENERGY STAR is a joint program of these government agencies, designed to promote energy efficient products and practices. Changes to certain features, settings, and functionalities of this TV (i.e. Picture/Sound, Power Savings) can increase or change the power consumption. Depending upon such changed settings, the power consumption may exceed the limits required for the ENERGY STAR qualification in the "Home" mode.

## Cleaning

When cleaning, be sure to unplug the power cord to avoid any chance of electric shock.

- Wipe the LCD screen gently with a soft cloth.
- Stubborn stains may be removed with a cloth slightly moistened with a solution of mild soap and warm water.
- If using a chemically pretreated cloth, please follow the instruction provided on the package.
- Never use strong solvents such as a thinner, alcohol or benzine for cleaning.
- See the supplied Safety Booklet for additional information.

## CAUTION

To prevent electric shock and blade exposure, do not use this polarized AC plug with an extension cord, receptacle or other outlet unless the blades can be fully inserted.

- Operate the TV only on 110-240 V AC.
- Avoid operating the TV at temperatures below 41°F (5°C).

## Licensing Information

Macintosh is a trademark of Apple Inc., registered in the U.S. and other countries.

HDMI, the HDMI logo and High-Definition Multimedia Interface are trademarks or registered trademarks of HDMI Licensing, LLC.

Ferguson Patent Properties, LLC:

U.S. Patent No. 5,717,422

U.S. Patent No. 6,816,141

Manufactured under license from Dolby Laboratories. Dolby, Pro Logic, and the double-D symbol are trademarks of Dolby Laboratories.

Blu-ray Disc is a trademark.

"BRAVIA" and BRAVIA, Motionflow, BRAVIA Sync, and  are trademarks or registered marks of Sony Corporation.

"PlayStation" is a registered trademark and "PS3" is a trademark of Sony Computer Entertainment Inc.



(KDL-32FA600 only)



The 32 class has a 31.5 inch viewable image size and the 55 class has a 54.6 inch viewable image size (measured diagonally).

# Contents

## **Introducing Your New BRAVIA®**

Welcome to the World of BRAVIA®	4
Experiencing Stunning HD with Your BRAVIA	4
The Four Steps to a Stunning HD Experience	5
TV Feature Highlights	5

## **Getting Started**

Setting Up Your TV	7
Locating Inputs and Outputs	8
Adjusting the viewing angle of the TV	10
Connecting the TV	10
Connecting Other Equipment	14
When Installing the TV Against a Wall or Enclosed Area	15
Securing the TV	16
Running Initial Setup	18

## **Operating the TV**

Using the Remote Control	19
Remote Control Button Description	20
TV Controls and Indicators	24

## **Using Features**

BRAVIA® Sync™ with Control for HDMI	25
Using PIP Feature	26
Favorites	27
Wide Mode	27
Wide Mode with PC	28
Inputs	28
Playing back Photo/Music/Video via USB	29

## **Using the Menus**

Navigating through TV Menus	30
Using the Picture Settings	31
Using the Sound Settings	33
Using the Screen Settings	35
Using the Channel Settings	37
Using the Parental Lock Settings	38
Using the Setup Settings	41
Using the Eco Settings	45

## **Other Information**

PC Input Signal Reference Chart for PC and HDMI IN 1/2/3/4	46
Using a Wall-Mount Bracket	47
Installing the Wall-Mount Bracket	47
Troubleshooting	52
Important Notices	56
Specifications	57
Index	59



### **Customer Support**

United States  
<http://www.sony.com/tvsupport>  
Canada  
<http://www.sony.ca/support>

### **On-line Registration**

United States  
<http://productregistration.sony.com>  
Canada  
<http://www.SonyStyle.ca/registration>

# Introducing Your New BRAVIA®

## Welcome to the World of BRAVIA®

Thank you for choosing this Sony BRAVIA® high-definition television. Use the documentations listed below to get the most out of your TV.



### Safety Booklet

Contains precautionary measures to keep you and your TV safe. Read this information prior to setting up your TV.



### Quick Setup Guide

Provides TV setup information with sample connection diagrams.



### Operating Instructions

Provides the most detailed information to operate your TV.

## Experiencing Stunning HD with Your BRAVIA

The quality of the image you see on your **BRAVIA** TV is only as good as the quality of the signal it receives. To experience the stunning detail of your new **BRAVIA** TV, you need access to HD programming. Your **BRAVIA** TV can receive and display HD programming from:

- Over-the-air broadcasting via HD-quality antenna
- HD cable subscription
- HD satellite subscription
- Blu-ray Disc™ player or other HD compatible external equipment

Contact your cable, satellite or HD service provider for information on upgrading to HD programming.

# The Four Steps to a Stunning HD Experience

## Set, Source, Sound, and Setup

Along with your **BRAVIA TV set**, a complete HD system requires a **source** of HD programming, an HD **sound** system, and a proper connection **setup**. Refer to the Quick Setup Guide, enclosed separately, for connecting optional equipment.



You can enjoy crisp, clear images, smooth movement, and high-impact visuals from 1080 HD signals as shown here.

When you compare a high-definition signal to a standard analog signal, you will notice a big difference in picture quality. If black bars appear as shown here, press **WIDE** on the remote control to fill the screen.

## TV Feature Highlights

Your **BRAVIA** comes with many convenient features, such as:

- **BRAVIA® Sync™**: Allows your **BRAVIA TV** to communicate with other Sony equipment supporting the **Control for HDMI** function (page 25).
- **Digital Media Accessibility**: Use the **Photo**, **Music**, and **Video** icons to access photo, music, and video files from Sony USB equipment (page 29).
- **PIP (Picture in Picture)**: You can work on your PC and watch your favorite TV program simultaneously (page 26).
- **Favorites**: Your favorite channels and inputs are at your finger tips for easy access (page 27).
- **Auto Wide Mode**: Set your TV to automatically adjust the screen based on the signal resolution (page 27).
- **Input Selection**: Allows you to easily switch between the connected equipment (page 28).
- **Motionflow**: Enhance the smooth picture movements to reduce the blur (page 31). (This feature is available for models: EX500 and EX501.)
- **Scene Select**: Allows you to easily adjust your TV to the most suitable picture and sound settings based on the scenes for the best quality result for the contents genre you are watching (page 21).

- **Ambient Sensor:** Automatically optimizes the picture settings according to the ambient light in the room. The sensor detects ambient light levels to adjust the brightness and color temperature of the picture. With this feature you can have the best picture quality under your room's lighting conditions (page 32).

# Getting Started

## Setting Up Your TV

Some TV models are packaged with a detached Table-Top Stand so you can mount your TV to a wall right away. If you are not mounting the TV to a wall, you will need to attach the Table-Top Stand. You will need a Phillips screwdriver and the supplied screws to complete the task. Look for the attachment instructions provided with the TV.

Be sure to consider the following while setting up your TV:

- Disconnect all cables when carrying the TV.
- Carry the TV with the adequate number of people; larger size TVs require two or more people.
- Correct hand placement while carrying the TV is very important for safety and to avoid damage.

Except KDL-32FA600 model

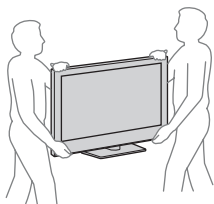

KDL-32FA600 model only

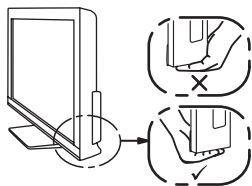
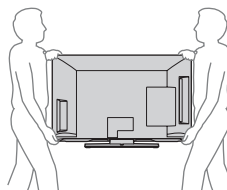

- Place your palm directly underneath but do not squeeze the panel's speaker grill area.

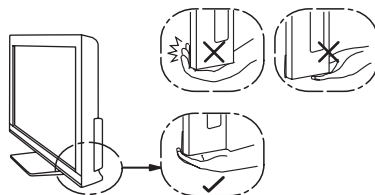

- Ensure your TV has adequate ventilation, see page 15.
- For best picture quality, do not expose the screen to direct illumination or sunlight.
- Avoid installing the TV in a room with reflective wall and floor materials.
- Avoid moving the TV from a cold area to a warm area. Sudden room temperature changes may cause moisture condensation. This may cause the TV to show poor picture and/or poor color. Should this occur, allow moisture to evaporate completely before powering the TV on.

# Locating Inputs and Outputs

Rear Panel

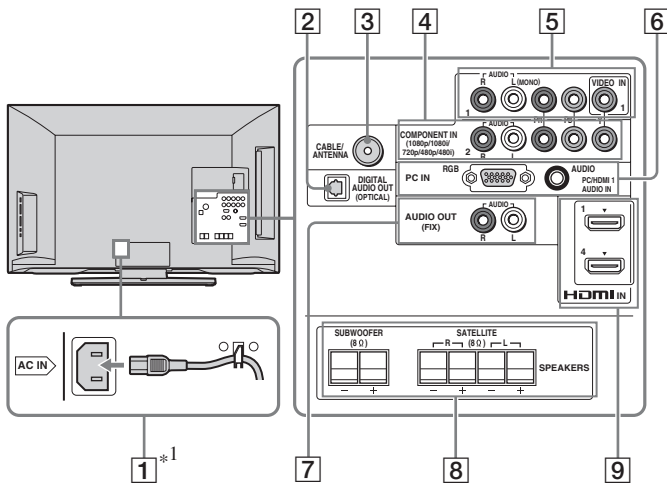

Side Panel

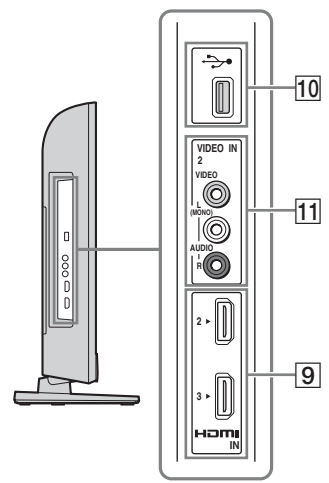

Item	Description
1 AC IN	Connect the supplied power cord to AC IN and the nearest wall outlet.
2 DIGITAL AUDIO OUT (OPTICAL)	Connects to the optical audio input of digital audio equipment that is PCM/Dolby* <sup>2</sup> Digital compatible.
3 CABLE/ANTENNA	RF input that connects to your Cable or VHF/UHF antenna.
4 COMPONENT IN 2 (1080p/1080i/720p/480p/480i) R-AUDIO-L	Component video provides better picture quality than the composite video. Audio connection is required for the COMPONENT IN ports, connect audio (L/R).
5 VIDEO IN 1 / COMPONENT IN 1 (1080p/1080i/720p/480p/480i) R-AUDIO-L (MONO)	This input port can be used as a composite video input (VIDEO 1) or as a component video input (COMPONENT 1). For composite use, connect the yellow jack to Y for video and use audio L (mono) and R for audio signal. For component connection, use Y, Pb, Pr for video signals and also connect the audio L (mono) and R for audio signal. This TV can auto detect and switch between the VIDEO 1 and COMPONENT 1 when VIDEO 1 or COMPONENT 1 is connected. To set to auto detection, press <b>MENU</b> , select <b>Settings</b> , and then select the <b>Setup</b> settings. Select the <b>Video/Component 1 Selection</b> option then set to <b>Auto</b> .

\*<sup>1</sup> In the case of 32 and 40 inch models, the AC power cord is attached to the TV.

\*<sup>2</sup> Manufactured under license from Dolby Laboratories. Dolby and the double-D symbol are trademarks of Dolby Laboratories.



<i>Item</i>	<i>Description</i>
<b>6 PC IN (RGB/AUDIO)</b>	<p>Connects to a personal computer's video and audio output connector. Can also be connected to other analog RGB equipment. See "PC Input Signal Reference Chart" on page 46 for the signals that can be displayed.</p> <p>For some Apple Macintosh computers, it may be necessary to use an adapter (not supplied). If an adapter is used, connect the adapter to the computer before connecting the HD15-HD15 cable.</p> <p>You may need to adjust the TV settings or your PC's resolution and timing. See page 13 for information on how to setup your PC to this TV.</p>
<b>7 AUDIO OUT (FIX) R/L</b>	<p>Connects to the left and right audio input jacks of your analog audio equipment. You can use these outputs to listen to your TV's audio through your stereo system.</p>
<b>8 SPEAKERS SUBWOOFER (8Ω) SATELLITE (8Ω)R/L (KDL-32FA600 only)</b>	<p>Connects the Subwoofer and the Satellite Speakers (supplied with KDL-32FA600) to the TV.</p>
<b>9 HDMI IN 1/2/3/4</b>	<p>HDMI (High-Definition Multimedia Interface) provides an uncompressed, all-digital audio/video interface between this TV and any HDMI-equipped audio/video equipment, such as a set-top box, DVD player, and A/V receiver. HDMI supports enhanced, or high-definition video, plus digital audio. Be sure to use only an HDMI cable that bears the HDMI logo.</p> <p>Use the HDMI IN 1 port when connecting DVI equipment. Use a DVI-to-HDMI cable or adapter (not supplied). Equipment using a DVI connection also requires an additional audio connection using an audio cable connected to AUDIO of PC IN.</p>
<b>10 USB</b>	<p>Connects to USB equipment to access photo, music, and video files.</p>
<b>11 VIDEO IN 2 VIDEO/L (MONO)-AUDIO-R</b>	<p>Connects to the composite video output jack of video equipment.</p> <p>If you have mono equipment, connect its audio output port to the TV's L (MONO) audio input port.</p>



- An HDMI or Component video (YPbPr) connection is required to view 480i, 480p, 720p, 1080i and 1080p video formats. 1080/24p is available only with HDMI connection.

# Adjusting the viewing angle of the TV

For KDL-55EX500/KDL-46EX500/KDL-40EX500/KDL-32EX500/KDL-55EX501/KDL-46EX501/KDL-40EX501

This TV can be adjusted within the angle shown below.

**Adjust the angle left and right (swivel)**

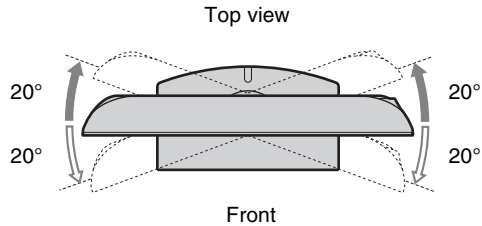

## Connecting the TV

### 5.1 Surround Sound System (KDL-32FA600 only)

Refer to the supplied Quick Setup Guide for details.

### Cable System or VHF/UHF Antenna System

You can enjoy high-definition and standard-definition digital programming (if available in your area) along with standard-definition analog programming.

This TV is capable of receiving unscrambled digital programming for both cable (QAM and 8VSB) and external VHF/UHF antenna (ATSC).

**Cable or VHF/UHF (or VHF only)**



- It is strongly recommended that you connect the CABLE/ANTENNA input using a 75-ohm coaxial cable to receive optimum picture quality. A 300-ohm twin lead cable can easily be affected by radio frequency interference, resulting in signal degradation.

# Cable System and VHF/UHF Antenna System

Use an optional A-B RF switch (not supplied) to switch between the cable and over-the-air antenna programming, as indicated below.

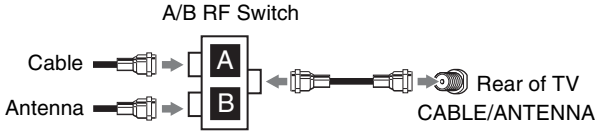

- Be sure to set the **Signal Type** setting to **Cable** or **Antenna** found under the **Channel** settings for your input signal (see page 37).

## HD Cable Box/HD Satellite Box

You can enjoy high-definition programming by subscribing to a high-definition cable service or a high-definition satellite service. For the best possible picture, make sure you connect this equipment to your TV via the HDMI or component video (with audio) input located on the back of your TV.

### Shown with HDMI Connection

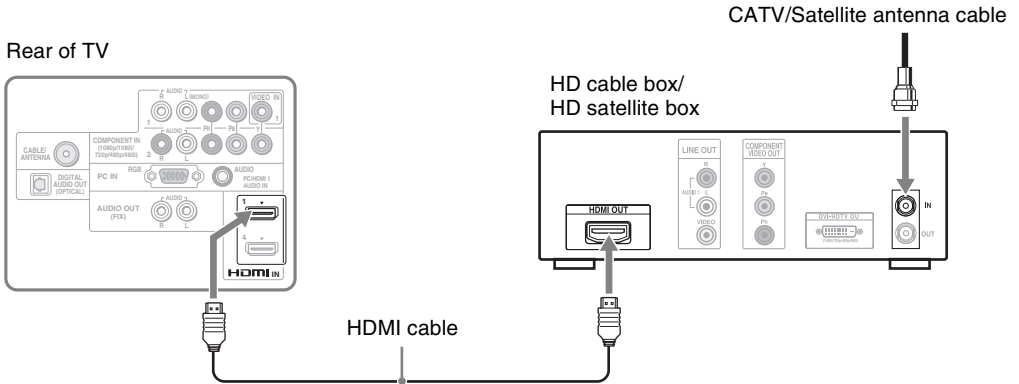

## Shown with DVI Connection

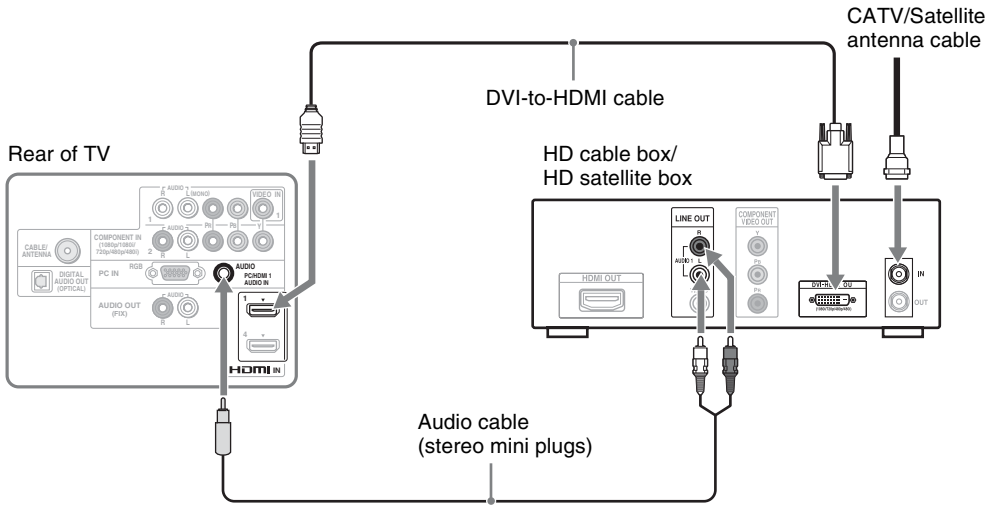

## Shown with Component Connection

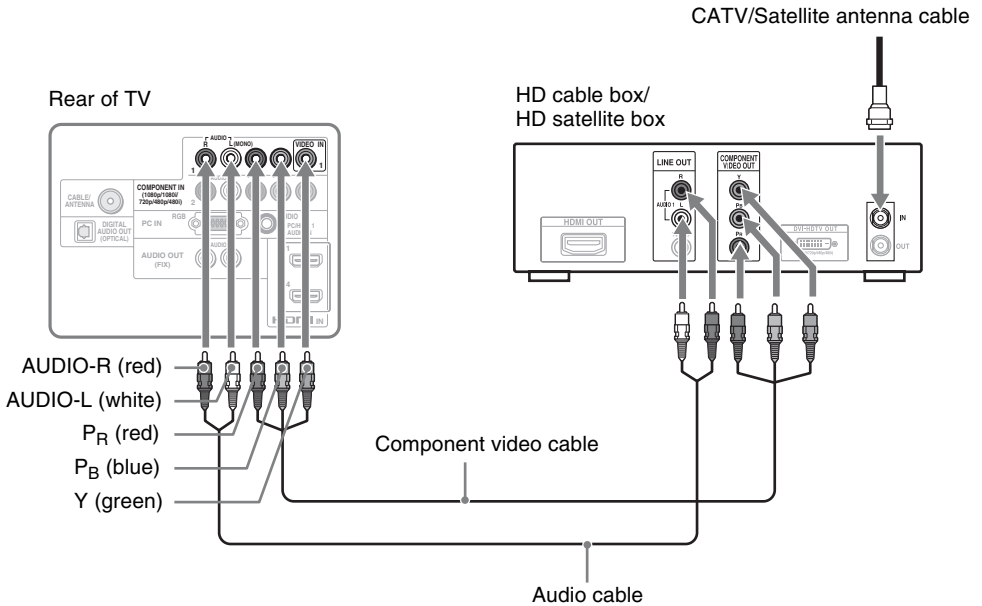

- If your equipment has a DVI output and not an HDMI output, connect the DVI output to the HDMI IN 1 (with DVI-to-HDMI cable or adapter) and connect the audio output to the AUDIO IN of PC IN. For details, see page 9.

## PC

Use the TV as a monitor for your PC by connecting an HD15-HD15 cable connection as shown below. This TV can also be connected to a PC with a DVI or HDMI output. (Refer to the separate Quick Setup Guide.)

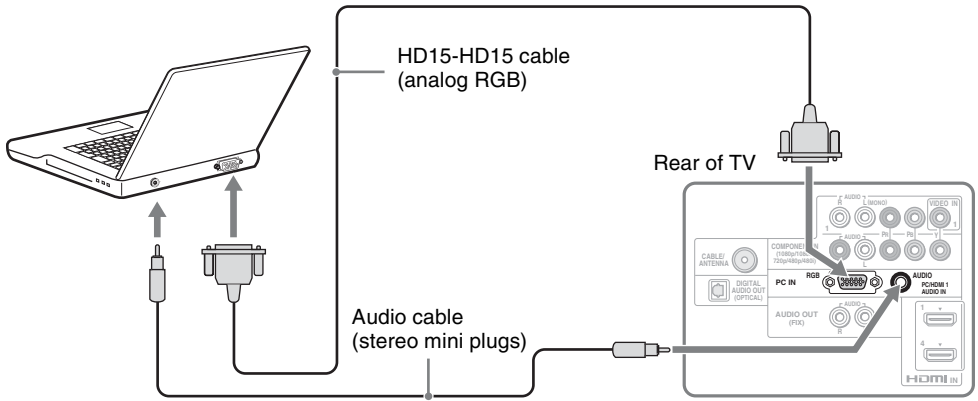

- Connect the PC IN jack to the PC using an HD15-HD15 cable with ferrite core (analog RGB) and audio cable (see page 9).

# Connecting Other Equipment

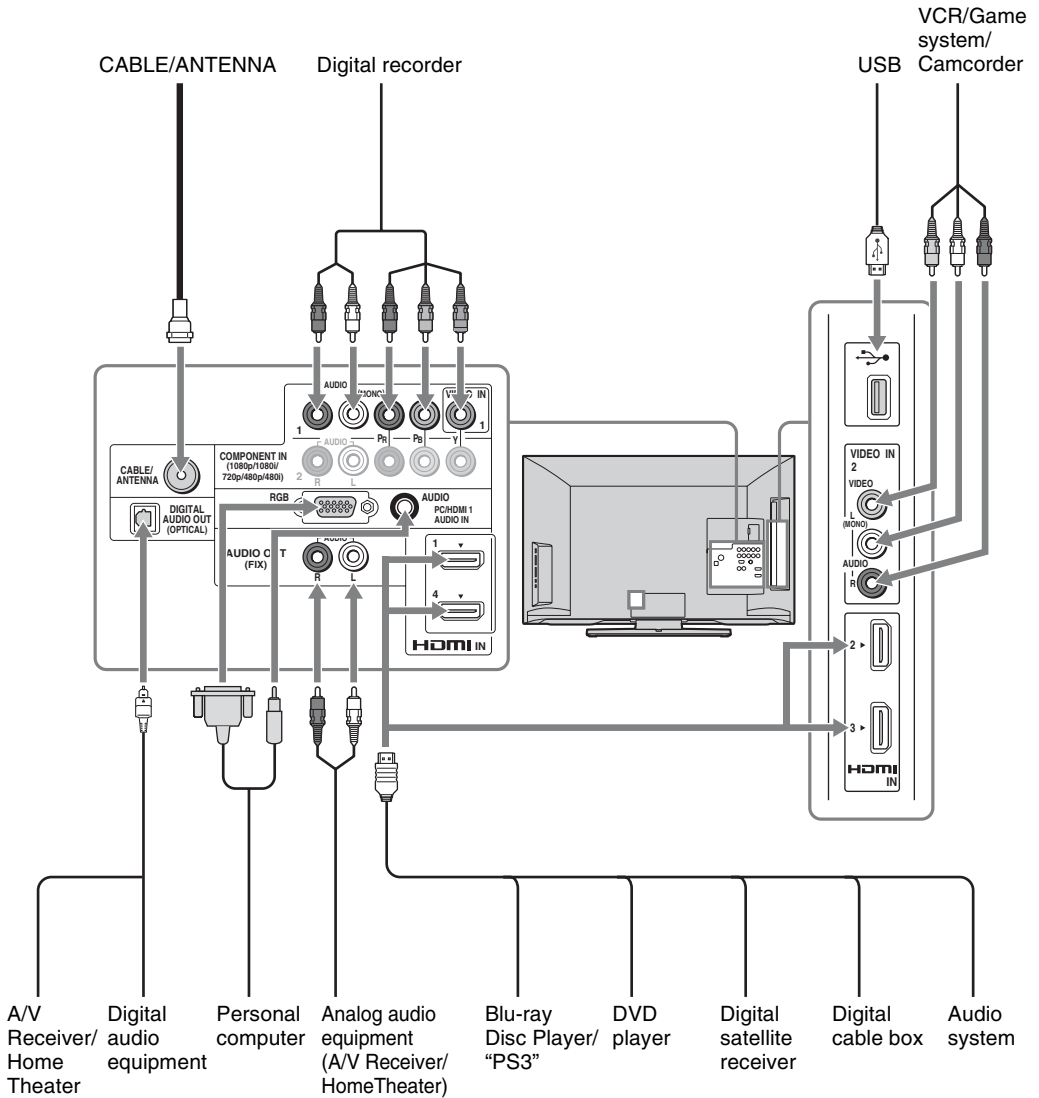

- Refer to the Quick Setup Guide (supplied) when connecting other equipment to your TV.

## When Installing the TV Against a Wall or Enclosed Area

Make sure that your TV has adequate ventilation. Allow enough space around the TV as shown below. Avoid operating the TV at temperatures below 41 °F (5 °C).

### Installed with stand

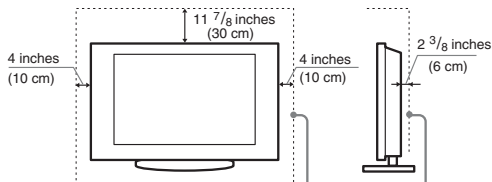

Leave at least this much space around the set.

### Installed on the wall

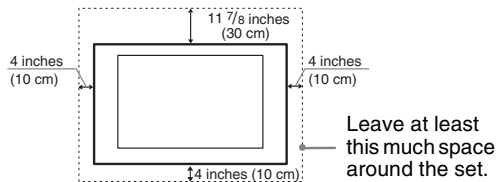

Never install the TV set as follows:

Air circulation is blocked.

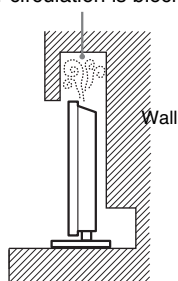

Air circulation is blocked.

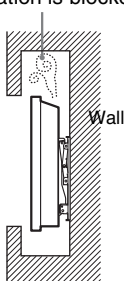

- Inadequate ventilation can lead to overheating of the TV and may cause TV damage or cause a fire.

## Securing the TV



Sony strongly recommends taking measures to prevent the TV from toppling over. Unsecured TVs may topple and result in property damage, serious bodily injury or even death.

### Preventing the TV from Toppling

- Secure the TV to a wall and/or stand.
- Do not allow children to play or climb on furniture and TV sets.
- Avoid placing or hanging items on the TV.
- Never install the TV on:
  - slippery, unstable and/or uneven surfaces.
  - furniture that can easily be used as steps, such as a chest of drawers.
- Install the TV where it cannot be pulled, pushed, or knocked over.
- Route all AC power cords and connecting cables so that they are not accessible to curious children.

### Recommended Measures to Secure the TV

Consider the following measures when securing your TV to a TV stand (not supplied).

#### 1 Secure the stand for the TV.

Make sure the TV stand can adequately support the weight of the TV. Use two angle braces (not supplied) to secure the stand.

For each angle brace use the appropriate hardware to:

- attach one side of the angle brace to the wall stud.
- attach the other side to the TV stand.

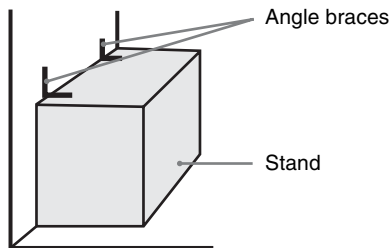



## 2 Secure the TV to the stand.

### Except KDL-32FA600 model

Use the optional hardware listed below (not supplied):

- M4 × 16 mm anchor bolt (screwed into the TV's Table-Top Stand).
- A screw or similar (attach it to the TV stand).
- Rope or chain (strong enough to support the weight of the TV). Make sure that there is no excess slack in the rope or chain.

An alternative way to secure the TV is with an optional Sony Support Belt Kit.

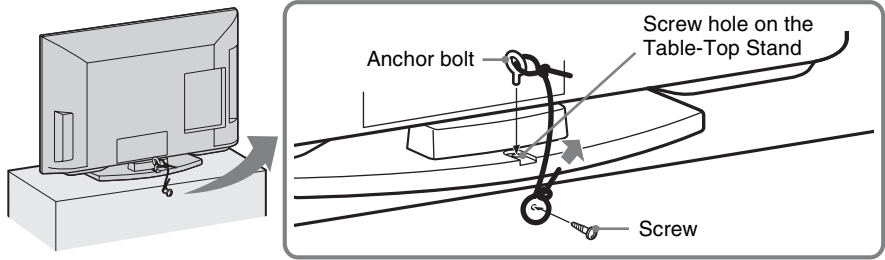

### KDL-32FA600 model only

Use an optional Sony Support Belt Kit.

## 3 Anchor the TV to the wall.

Use the hardware listed below (not supplied).

- Two anchor bolts, size M6 × 10-12 mm. Screw the bolts into the top-most wall-mount holes located on the rear of the TV.
- Rope or chain (attach to one anchor bolt).
- Wall-anchor (attach to the wall stud) strong enough to support the weight of the TV (pass the rope through the wall-anchor, then attach to the other anchor bolt).

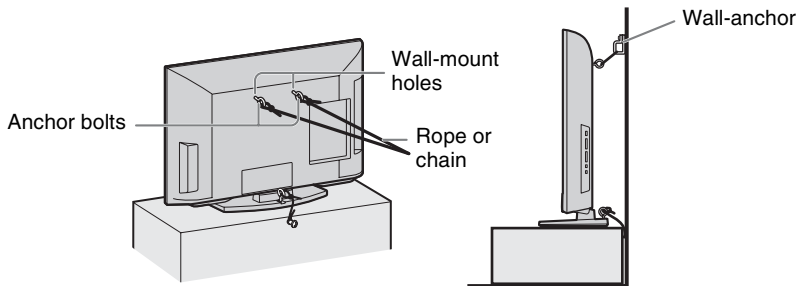

- Contact Sony Customer Support to obtain the optional Support Belt Kit by providing your TV model name.

For United States call: 1-800-488-7669 or visit: [www.sony.com/accessories](http://www.sony.com/accessories)

For Canada call: 1-877-899-7669

- Measure 2 provides minimal protection against the TV toppling over. For further protection, follow all three measures recommended above.
- If an electric screwdriver is used, set the torque to tighten at approximately 1.5 N·m { 15 kgf·cm }.

# Running Initial Setup

During initial setup, you will perform the following:

- Set the language for the On Screen Display (OSD) text
- Choose your viewing environment
- Scan for digital and analog channels

Complete your cable connections before beginning the **Initial Setup**. Refer to the Quick Setup Guide (supplied) for sample connection diagrams.

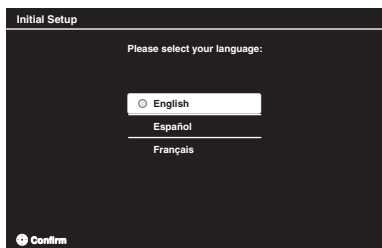

- 1 Turn on the TV. The **Initial Setup** screen will appear.
- 2 Use the remote control buttons described below to navigate through the **Initial Setup**.



### ↑/↓/←/→ buttons:

Allow you to navigate and highlight options where applicable.

### ⊕ button:

Allows you to select the highlighted option and advance to the next screen.

- 3 **Auto Program** will scan for available channels from the signal source directly connected to the TV's CABLE/ANTENNA input. Follow the help text provided on the screen to run the **Auto Program**.



- When prompted to select **Retail** or **Home**, be sure to select **Home** for ENERGY STAR compliant mode.
- Select **Cancel** to stop or cancel the **Auto Program**. The **Auto Program** can be done at later time. To run **Auto Program** at a later time, press **MENU**, select **Settings**, and then select **Auto Program** under **Channel** settings.
- Connect either your cable or antenna to the TV (you can connect both using an A-B RF switch (not supplied)); for more details see page 11.
- Select your preferred aspect ratio for the screen display. Press **WIDE** to select **Wide Mode**, or press **MENU** and select **Settings**, and then set **Auto Wide** to **On** under the **Screen** settings. For more details, see page 27.

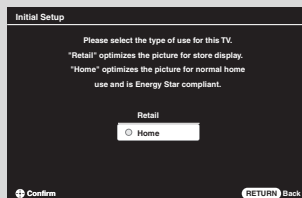

# Operating the TV

## Using the Remote Control

### To Insert Batteries into the Remote Control

Insert two size AAA batteries (supplied) by matching  $\oplus$  and  $\ominus$  on the batteries to the diagram inside the battery compartment of the remote control.

For KDL-32/40/46/55/60EX500,  
KDL-40/46/55EX501 models

For KDL-32/40/46EX400, KDL-40/46EX401,  
KDL-32EX301, KDL-32FA600 models

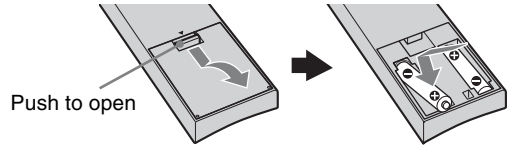
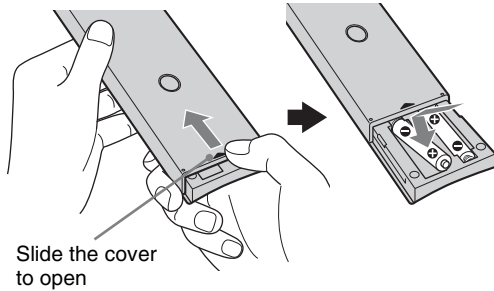

### Guidelines to follow

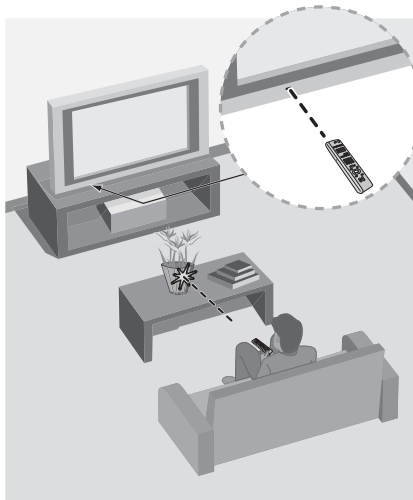

- Point your remote control directly at the IR sensor located on your TV.
- Make sure that no objects are blocking the path between the remote control and the IR sensor on your TV.
- Fluorescent lamps can interfere with your remote control; try turning off the fluorescent lamps.
- If you are having problems with the remote control, reinsert or replace your batteries and make sure that they are correctly inserted.

## Remote Control Button Description



Button	Description
1 INPUT	Press to display the list of External Inputs and TV mode. Press repeatedly to toggle through the inputs. See page 28.
2 BRAVIA Sync	<p>These buttons are used to control the equipment connected to the TV by using the <b>Control for HDMI</b> function (not available on all <b>Control for HDMI</b> equipment). Some other buttons on the remote control may also operate <b>BRAVIA</b>® Sync™ equipment.</p> <p><b>THEATER:</b> Press to turn on and off the <b>Theater Mode</b>. The picture settings will be set for a cinematic experience and the audio will be switched to the audio output of the attached speakers of your <b>BRAVIA Sync</b> audio system. Your <b>BRAVIA Sync</b> audio system must be connected by an HDMI connection to your TV (see page 25 for details).</p> <p>◀◀ (<b>fast reverse</b>): Press to play a program in fast rewind mode.</p> <p>▶ <b>PLAY:</b> Press to play a program at a normal speed.</p> <p>▶▶ (<b>fast forward</b>): Press to play a program in fast forward mode.</p> <p><b>SYNC MENU:</b> Press to display the <b>BRAVIA Sync</b> Menu and then select connected HDMI equipment from <b>HDMI Device Selection</b>.</p> <p>◀◀ <b>PREV:</b> Press to replay the current program from the previous chapter mark (if any) or from the beginning of the live TV cache.</p> <p>■ <b>STOP:</b> Press to stop playback.</p> <p>▶▶ <b>NEXT:</b> Press to advance forward to the next chapter mark (if any) or to live TV when playing back a recorded program.</p>
3 CC	Press to cycle through the available settings for <b>Closed Captions (CC)</b> : <b>On</b> , <b>Off</b> , and <b>On when Muting</b> .
4 FAVORITES	Press once to display the stored <b>Favorites</b> list. You can store up to 10 channels and/or external inputs in your <b>Favorites</b> list.



- The 5. **PLAY** and **CH +** buttons have a tactile dot. Use them as a reference when operating the TV.

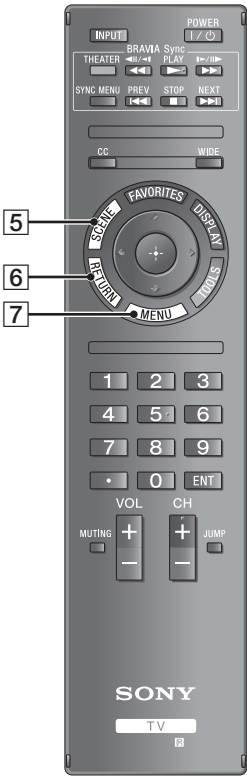

Button	Description
<b>5</b> SCENE	Optimizes picture and sound quality by selecting the following items. <b>Cinema:</b> Delivers picture scenes and sound just like those in a theater. <b>Sports:</b> Presents realistic pictures and sound just like those in a stadium. <b>Photo:</b> Reproduces the texture and color of a printed photo. <b>Music:</b> Lets you experience dynamic and clear sound just like at a concert. <b>Game:</b> Broadens your game-playing experience with superb picture and sound quality. <b>Graphics:</b> Eases prolonged monitor viewing with clearer detailed pictures. <b>General:</b> No optimized picture and sound quality for any scene. <b>Auto:</b> Automatically optimizes picture and sound quality according to the input source.
<b>6</b> RETURN	Press to go back to the previous screen or exit from the screen when displaying menu items and settings.
<b>7</b> MENU	Press to display the menu with TV functions and settings. See "Using the Menus" on page 30.



- When you set **Scene Select** to **Photo**, **Music**, **Cinema**, **Game** or **Sports**, **Sound Mode** is automatically set to **Dynamic**.
- When you set **Theater Mode** to **On**, **Cinema** is automatically set.

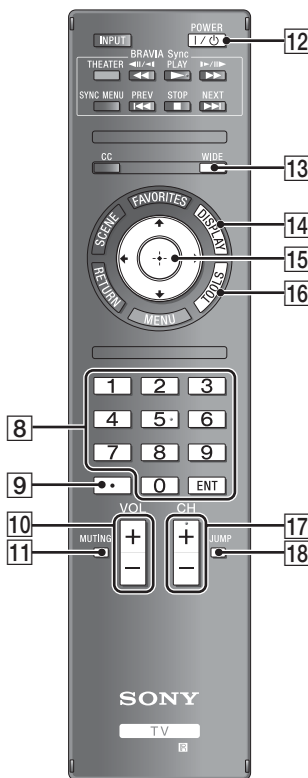

Button	Description
<b>8</b> 0-9 ENT	Press <b>0-9</b> to select a channel. Press <b>ENT</b> to change channels immediately.
<b>9</b> .	Use with <b>0-9</b> and <b>ENT</b> to select digital channels. For example, to enter 2.1, press <b>2</b> , <b>.</b> , <b>1</b> and <b>ENT</b> .
<b>10</b> VOL +/-	Press to adjust the volume.
<b>11</b> MUTING	Press to mute the sound. Press again or press <b>VOL +</b> to restore the sound.
<b>12</b> POWER I/O	Press to turn on and off the TV.
<b>13</b> WIDE	Press repeatedly to cycle through the available <b>Wide Mode</b> settings. See page 27.
<b>14</b> DISPLAY	Press once to display the banner with channel/program information you are watching. The banner will time out in a few seconds or press again to exit.
<b>15</b> ↑/↓/←/→ (+)	Press <b>↑/↓/←/→</b> to move focus/highlight. Press <b>(+)</b> to select/confirm an item.
<b>16</b> TOOLS	Press to display a list of convenient functions and menu shortcuts. The <b>TOOLS</b> menu items vary based on current input and content.
<b>17</b> CH +/-	Press to scan through channels. To scan quickly through channels, press and hold down either <b>CH +/-</b> .
<b>18</b> JUMP	Press to jump back and forth between two channels and external inputs. The TV alternates between the current/last channel or external input selected.

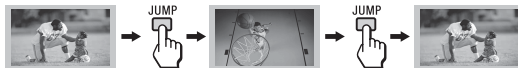

## Rear of Remote Control



Button	Description
19  <b>(Power)</b>	Press to turn on and off the TV. Available models : KDL-60EX500/KDL-55EX500/ KDL-46EX500/KDL-40EX500/KDL-32EX500/ KDL-55EX501/KDL-46EX501/KDL-40EX501

# TV Controls and Indicators

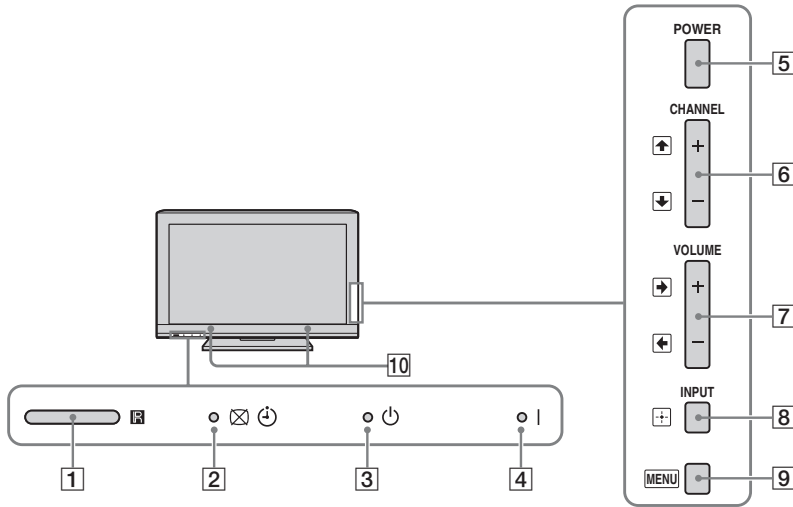

Item	Description
1 <b>Ambient sensor</b>	Senses room light level and adjusts the screen brightness accordingly. Do not put anything over the sensor, doing so may affect its function.
(IR) <b>Infrared Receiver</b>	Receives IR signal from the remote control.
2 <b>Picture Off/Timer LED</b>	Lights up in orange when the sleep timer is set. Lights up in green when the <b>Power Saving</b> is set to <b>Picture Off</b> .
3 <b>Standby LED</b>	Lights up in red when the TV is in standby mode.
4 <b>Power LED</b>	Lights up in green when the TV is turned on.
5 <b>POWER</b>	Press to turn on and off the TV.
6 <b>CHANNEL +/-</b>	Press to scan through channels. To scan quickly through channels, press and hold down either <b>CH -/+</b> . In the menu screen, these buttons serve as up/down buttons.
7 <b>VOLUME +/-</b>	Press to adjust the volume. In the menu screen, these buttons serve as left/right buttons.
8 <b>INPUT</b>	Press to display the list of external inputs. Press repeatedly to toggle through the inputs. In the menu screen, this button serves as confirming the selection or setting.
9 <b>MENU</b>	Press to display menu with TV functions and settings (see “Using the Menus” on page 30).
10 <b>Speaker</b>	Outputs audio signal.



- Inputs can be changed by pressing **▲/▼** and **-|-** while the list of external inputs menu is displayed.
- For more information about setting up the external inputs labels and the **Skip** feature, see page 42.
- The CHANNEL + button has a tactile dot. Use it as a reference when operating the TV.
- Make sure that the TV is completely switched off before unplugging the power cord.



# Using Features

## **BRAVIA® Sync™ with Control for HDMI**

With the **Control for HDMI** function, **BRAVIA Sync** helps to communicate with **BRAVIA Sync**-compatible equipment using HDMI CEC (Consumer Electronics Control). Use the following settings and tips to help unify control of your connected equipment.

- 1 Press **MENU** and select **Settings**, then select the **Setup** settings.
- 2 Select the **HDMI Settings**, then highlight **Control for HDMI**, and set to **On**.

### Controlling BRAVIA Sync-Compatible Equipment

To control the equipment by using the remote control, press **SYNC MENU** and select the desired equipment from **HDMI Device Selection**.



### BD/DVD Player

- Automatically turns the **BRAVIA Sync**-compatible equipment on and switches the input to that equipment when you select it from the **Sync Menu**.
- Automatically turns the TV on and switches the input to the connected equipment when the equipment starts to play.
- Automatically turns the connected equipment off when you switch the TV to standby mode.

### AV Amplifier

- Automatically turns the connected AV amplifier on and switches the sound output from the TV speaker to the audio system when you turn the TV on. This function is only available if you have previously used the AV amplifier to output TV sound.
- Automatically switches the sound output to the AV amplifier by turning the AV amplifier on when the TV is turned on.
- Automatically turns the connected AV amplifier off when you switch the TV to standby mode.
- Adjusts the volume (**VOL +/-**) and mutes the sound (**MUTING**) of the connected AV amplifier through the TV's remote control.

### Video Camera

- Automatically turns the TV on and switches the input to the connected video camera when the connected video camera is turned on.
- Automatically turns the connected video camera off when you switch the TV to standby mode.



- **Control for HDMI (BRAVIA Sync)** is only available for the connected Sony equipment that has the **BRAVIA Sync** or is compatible with **Control for HDMI**.
- The **Control for HDMI** settings must be set on both the TV and connected equipment. For settings on the connected equipment, refer to their instruction manuals.
- When specific Sony equipment compatible with **Control for HDMI (BRAVIA Sync)** is connected, **BRAVIA sync** is automatically activated on the equipment.

## Using PIP Feature

**PIP** (picture in picture) displays a picture from a connected PC in full screen, and a TV program or other external input (see below “To Enter PIP” table) in an inset window. (**Closed Captions (CC)** is not available with **PIP** mode.)



### To Enter PIP

PIP Supported Inputs	
In main window	In sub window
PC	TV channel (CABLE/ANTENNA), VIDEO IN 1/2, HDMI IN 1/2/3/4 (video timing)
HDMI IN 1/2/3/4 (PC timing)	TV channel (CABLE/ANTENNA), VIDEO IN 1/2, COMPONENT IN 1/2

- 1 Press **TOOLS** while in the PC mode.
- 2 Select **PIP** from the **TOOLS** menu.
- 3 The sub window will appear.

### To Change Channels

You can change the channel of the sub window by pressing **CH +/-** or entering the channel number using the **0-9** numeric buttons.

### To Exit from PIP

- 1 Press **TOOLS**.
- 2 Press **▲/▼** to highlight **Exit PIP** and press **⊕** to exit to full PC screen.

### To Swap Audio

You can swap audio between the main and sub window.

- 1 Press **TOOLS**.
- 2 Press **▲/▼** to highlight **Audio Swap** and press **⊕**.
- 3 Press **▲/▼** to highlight the window to be audible, then press **⊕**.

## Favorites

Your favorite channels and external inputs can be easily accessed by pressing the **FAVORITES** button once they are added to the list.

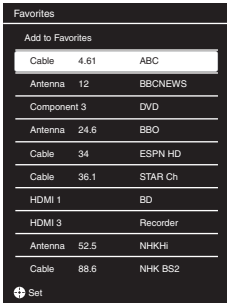

### Adding to Favorites

While tuned to the channel you want to watch or viewing connected equipment, press **FAVORITES** to display the list. Highlight **Add to Favorites**, then press  $\oplus$ . Your newly added item will be listed at the top of the list. When you continue to add items beyond the 10th item, the item listed at the bottom of the list will be automatically removed from the list.

## Wide Mode

The **Wide Mode** feature allows you to select the screen display of your preference. Based on the original signal source, you may see black bars around the picture or just on the both sides of the screen. Sometimes you will see the picture fill the full screen. This is due to the signals your TV receives.

You can manually select available **Wide Mode** settings as you watch your TV by pressing the **WIDE** button on your remote control or you can set your TV to **Auto Wide**.

### To set Auto Wide

Press **MENU** and select **Settings**, then select the **Screen** settings. Select **Auto Wide** and set to **On**.

### To change the Wide Screen Mode

Press **WIDE** repeatedly to cycle through the available modes.

4:3 Original source	16:9 Original source
Standard-definition source 	High-definition source 
<b>Wide Zoom</b> 	<b>Wide Zoom</b> 
<b>Normal</b> 	<b>Normal</b> This mode is not available.
<b>Full</b> 	<b>Full</b> 
<b>Zoom</b> 	<b>Zoom</b> 

**Normal** is available with 480i or 480p sources only.



- Your **Favorites** list will be cleared each time you run the **Auto Program**.

## Wide Mode with PC

**Wide Mode** is also available for the **PC** settings. When a PC is connected to the TV and **PC** input is selected, you can change the PC Screen settings.

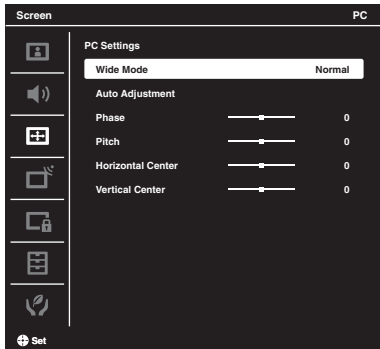

### To change the Wide Screen Mode for PC Timing

Press **WIDE** repeatedly to cycle through the available modes while in the PC input mode.

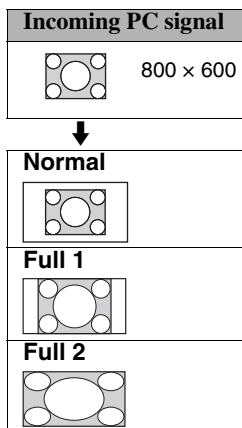

- Use the **Auto Adjustment** to adjust the display position and phase of the picture when the TV receives an input signal from the connected PC.

## Inputs

Press **INPUT** to display the **Input** menu and toggle through the external inputs to select your video signal for viewing including the TV mode. The inputs list consists of TV mode and other equipment connected to the TV.

You can label your external inputs to identify them easily.

### To Label an Input

- 1 Press **MENU** and select **Settings**, then select the **Setup** settings. Select the **Label Video Inputs** option. Press **▲/▼** to highlight the video input (**HDMI 1-4, Video 1-2, Component 1-2, PC**) to which you want to assign a label; press **⊕** to select the input of your choice.
- 2 Press **▲/▼** to highlight one of the displayed labels that corresponds to your connected equipment, then press **⊕**.
- 3 If you have an open input where no equipment is connected, you can label it as **Skip**. When you assign **Skip**, your TV will skip over this input when you press the **INPUT** button. The **Skip** labeled input is grayed out in the input list.

## Playing back Photo/Music/Video via USB

You can enjoy photo/music/video files stored in a Sony digital still camera or camcorder through a USB cable or USB storage device on your TV.

- 1 Connect a supported USB device to the TV.
- 2 Press **MENU**.
- 3 Press **▲/▼** to select **Photo**, **Music**, or **Video**, then press **⊕**.  
The file or folder list appears.
- 4 Press **▲/▼/◀/▶** to select a file or folder, then press **⊕**.  
When you select a folder, select a file, then press **⊕**.  
Playback starts.

**Picture Frame:** Allows you to display a photograph on the screen for a selected period of time. After that period, the TV automatically switches itself into standby mode.

**Playback Options:** Allows you to make adjustments for photo, music and video settings.

### Photo Playback Auto Start

The TV automatically displays the thumbnail view screen when the TV is turned on and a digital still camera or other device storing photo files is connected to the USB port then turned on (page 41).

### Notes when playing back files

- While the TV is accessing the data on the USB device, observe the following:
  - Do not turn off the TV or connected USB device.
  - Do not disconnect the USB cable.
  - Do not remove the USB device.

The data on the USB device may be damaged.





- Sony will not be held liable for any damage to, or loss of, data on the recording media due to a malfunction of any connected devices or the TV.
- Playback does not start automatically if the TV is turned on after connecting the digital still camera or other device to the USB port.
- USB playback is supported for the following photo file formats:
  - JPEG (JPEG format files with the extension “.jpg” and conforming to DCF 2.0 or Exif 2.21)
- USB playback is supported for the following music file format:
  - MP3 (files with the extension “.mp3” that have not been copyrighted)
- USB playback is supported for the following video file format:
  - MPEG1, MPEG2 (files with the extension “.mpg”)
- Photo Playback Auto Start works only for photo files in the newest digital still camera folder (DCF-compliant, highest-numbered “DCIM” folder).
- Playback may not start automatically when some digital still cameras (such as cameras with internal memory) are connected.
- The file name and folder name support only English.
- When you connect a Sony digital still camera, set the camera’s USB connection mode to “Auto” or “Mass Storage.” For more information about USB connection mode, refer to the instructions supplied with your digital camera.
- Use a USB storage device that is compliant with USB Mass Storage Class standards.

# Using the Menus

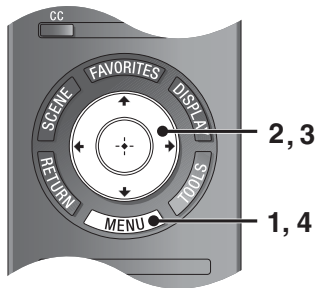
The **MENU** button allows you to access a variety of TV settings and USB media files.







## Navigating through TV Menus



- 1 Press  on the remote control to display the menu options.
- 2 Press  to navigate on the menu or adjust the settings.
- 3 Press  to select or confirm.
- 4 Press  to exit.



The **Settings** icon contains all of the necessary configurations to customize your TV settings. The options you can select may vary. Unavailable options are grayed out or not displayed.

-  **Picture:** adjust the picture on your TV to fit your viewing preference.
-  **Sound:** customize your sound settings to suit your audio preference. You can also change the settings to output the sound to your connected audio equipment.
-  **Screen:** adjust the size and shape of the images you see on the screen.
-  **Channel:** navigate your favorite channels and inputs and select the signal type, as well as autoprogram channels. You can also customize the channels you see and the labels assigned to them.
-  **Parental Lock:** set the password and limit access to programming based on rating levels. You can also block channels and inputs.
-  **Setup:** modify and customize a variety of general setting options.
-  **Eco:** changes the settings related to power consumption.



The **Photo**, **Music**, and **Video** icons organize your photo, music, and video files from Sony USB connected equipment. Be sure to select the correct icon when accessing files. Refer to the feature section for more information on these icons.

## Using the Picture Settings

<b>Option</b>	<b>Description</b>
<b>Picture Mode</b> <i>Customized picture viewing</i>	Displays the options selected in the <b>Scene Select</b> settings (see page 21). When <b>Scene Select</b> is set to <b>General</b> , the options below can be selected.
	<b>Vivid</b> Select for enhanced picture contrast and sharpness.
	<b>Standard</b> Select for standard picture settings. Recommended for home entertainment.
	<b>Custom</b> Select to store your preferred settings.
<b>Reset</b>	Resets the current <b>Picture</b> settings to their defaults, except <b>Picture Mode</b> and <b>Ambient Sensor</b> .
<b>Backlight</b>	Adjust to brighten or darken the backlight.
<b>Picture</b>	Adjust to increase or decrease picture contrast.
<b>Brightness</b>	Adjust to brighten or darken the picture.
<b>Color</b>	Adjust to increase or decrease color intensity.
<b>Hue</b>	Adjust to increase or decrease the green tones.
<b>Color Temperature</b> <i>White adjustment</i>	<b>Cool</b> Select to give the white colors a bluish tint.
	<b>Neutral</b> Select to give the white colors a neutral tint.
	<b>Warm 1/Warm 2</b> Select to give the white colors a reddish tint. <b>Warm 2</b> gives a redder tint than <b>Warm 1</b> .
<b>Sharpness</b>	Adjust to sharpen or soften the picture.
<b>Noise Reduction</b>	Select to reduce the picture noise level. Select from <b>Auto</b> , <b>High</b> , <b>Medium</b> , <b>Low</b> and <b>Off</b> .
<b>MPEG Noise Reduction</b>	Select to reduce the picture noise in MPEG-compressed videos. This is effective when viewing a DVD or digital broadcast. Select from <b>High</b> , <b>Medium</b> , <b>Low</b> and <b>Off</b> .
<b>Motionflow</b> <i>(KDL-32/40/46/55/60EX500, KDL-40/46/55EX501 models only)</i>	Provides smoother picture movement and reduces picture blur.
	<b>High</b> Select for smoother picture movement such as for film-based contents.
	<b>Standard</b> Select for smooth picture movement. Use this setting for standard use.
	<b>Off</b> Select when the <b>High</b> or <b>Standard</b> settings result in noise.
<b>CineMotion</b>	Provides improved picture movement and reduces picture blur and graininess for film-based content. Select <b>Auto 1</b> for standard use, or <b>Auto 2</b> or <b>Auto</b> to represent original film-based content as is.

<i>Option</i>	<i>Description</i>
<b>Advanced Settings</b>	<b>Reset</b> Resets the advanced settings to the default values.
	<b>Adv. Contrast Enhancer</b> Automatically adjusts backlight and contrast to the most suitable settings judging from the brightness of the screen. This setting is especially effective for dark scenes, and will increase the contrast distinction of the darker picture scenes. Select from <b>High, Medium, Low</b> and <b>Off</b> .
	<b>Black Corrector</b> Enhances black areas of the picture for stronger contrast. Select from <b>High, Medium, Low</b> and <b>Off</b> .
	<b>Gamma</b> Adjusts the balance between bright and dark areas of the picture.
	<b>Clear White</b> Emphasizes white colors. Select from <b>High, Low</b> and <b>Off</b> .
	<b>Live Color</b> Makes colors more vivid. Select from <b>High, Medium, Low</b> and <b>Off</b> .
	<b>White Balance</b> Adjusts the color temperature in detail.
<b>Ambient Sensor</b>	Select <b>On</b> to optimize the picture by sensing the lighting environment surrounding the TV. Select <b>Off</b> to disable this function.



- Even if you change the **Motionflow** setting, you may not see the effect visually depending on the content.
- Available **Picture** options, including options in **Advanced Settings** depend on **Scene Select** and **Picture Mode**.



## Using the Sound Settings

<i>Option</i>	<i>Description</i>
<b>Sound Mode</b> <i>Customized sound listening</i>	Sets a sound mode. <b>Sound Mode</b> includes options best suited for video and photographs, respectively. The available options depend on the scene select settings.
	<b>Dynamic</b> Enhances treble and bass.
	<b>Standard</b> Standard sound optimized for home use.
	<b>Clear Voice</b> Suitable for spoken dialog.
	<b>Custom</b> Select to store your preferred settings.
<b>Reset</b>	Resets the current <b>Sound Mode</b> settings to the default values.
<b>Treble</b>	Adjust to increase or decrease higher-pitched sounds.
<b>Bass</b>	Adjust to increase or decrease lower-pitched sounds.
<b>Equalizer</b>	<b>Adjust</b> allows you to select your frequency response curve. Select <b>Reset</b> to reset the <b>Equalizer</b> settings to the default values. (Available when <b>Sound Mode</b> is set to <b>Custom</b> .)
<b>Balance</b>	Adjust to emphasize left or right speaker balance.
<b>Dolby Pro Logic II</b> <i>(KDL-32FA600 only)</i>	<b>Movie</b> Select for a movie theater like sound.
	<b>Music</b> For steady music signals; gives natural sound to music and a concert like environment.
	<b>Matrix</b> Simulate multi-channel sound; great for mono programs.
	<b>Virtual</b> Creates a virtual surround sound, using the Dolby Pro Logic II system. On this mode we recommend to place the Satellite Speakers next to the TV (see more details in Quick Setup Guide).
	<b>Off</b> Turn off the Dolby Pro Logic II surround sound.
<b>Surround</b> <i>(Except KDL-32FA600)</i>	Allows you to select the suitable surround effects depending on the genre of TV program (movie, sport, music, etc.) or video game. The available options depend on the scene select settings.
	<b>On/Off</b> Select <b>On</b> to optimize the sound quality to enjoy the effects of the Surround option and to create a virtual surround sound using the 2ch speaker.
	<b>Cinema/Off</b> Provides surround effects just like the high-grade audio systems found in movie theaters.
	<b>Music/Off</b> Provides surround effects that make you feel like you are surrounded by sound as in a music hall.
	<b>Sports/Off</b> Provides surround effects that make you feel like you are watching a live sports contest.
	<b>Game/Off</b> Provides surround effects that enhance game sound.
<b>Test Tone</b> <i>(KDL-32FA600 only)</i>	Used to confirm and adjust speaker position and level.
<b>Volume Offset</b>	Adjust the volume level of the current input relative to other inputs.
<b>Steady Sound</b>	Select <b>On</b> to stabilize the volume across all programs and commercials. Select <b>Off</b> to disable this function.

<b>Option</b>	<b>Description</b>
<b>MTS Audio</b> <i>Enjoy stereo, bilingual and mono programs</i>	<b>Stereo</b> Select for stereo reception when viewing a program broadcast in stereo.
	<b>Auto SAP</b> Select to automatically switch the TV to second audio programs when a signal is received. If no <b>SAP</b> signal is present, the TV remains in <b>Stereo</b> mode.
	<b>Mono</b> Select for mono reception. Use to reduce noise during weak stereo broadcasts.
<b>Alternate Audio</b> <i>Digital channels only</i>	Select among the available options to switch among the alternate audio streams. The program you are tuned to may be broadcasted in a different language in the alternate audio streams.
<b>Speakers</b>	<b>TV Speakers</b> Select to use the TV speakers.
	<b>Audio System</b> Select to use an external audio system for the TV sound. By selecting this option you are disabling the TV speakers.



- **MTS Audio** is only available for analog programs.
- **Alternate Audio** is only available if the program is broadcast with alternate audio streams.
- You can also access **Sound Mode**, **MTS Audio** and **Alternate Audio** by using the **TOOLS** button on the remote control.

## Using the Screen Settings

Option	Description
<b>Wide Mode</b>	<b>Wide Zoom</b> Fills the screen with minimum distortion.
	<b>Normal</b> Select to display 4:3 picture in original size when the original source is 4:3.
	<b>Full</b> Select to enlarge the picture horizontally to fill the screen when the original source is 4:3 (Standard definition source). When the original source is 16:9 (High-definition source), select this mode to display the 16:9 picture in its original size.
	<b>Zoom</b> Select to enlarge the original picture without distorting the aspect ratio.
<b>Auto Wide</b>	<b>On</b> Select <b>On</b> to automatically change <b>Wide Mode</b> setting based on the content.
	<b>Off</b> If frequent screen changes are disturbing to you, select <b>Off</b> . Choose one of the <b>Wide Mode</b> options when this function is set to <b>Off</b> .
<b>4:3 Default</b> <i>Select the default Screen Mode to use for 4:3 sources</i>	<b>Wide Zoom</b> Enlarges the 4:3 picture to fill the 16:9 screen, displaying as much of the original image as possible.
	<b>Normal</b> Select to display the 4:3 picture in its original size.
	<b>Full</b> Select to enlarge the 4:3 picture horizontally only, to fill the display area.
	<b>Zoom</b> Select to enlarge the picture horizontally and vertically to an equal aspect ratio that fills the wide screen.
	<b>Off</b> Select to continue using the current <b>Wide Mode</b> setting when the channel or input is changed.
<b>Display Area</b>	<b>Full Pixel</b> Displays pictures in their original size when parts of the picture are cut off (available depending on the TV model).
	<b>+1</b> Displays pictures in their original size.
	<b>Normal</b> Displays pictures in their recommended size.
	<b>-1</b> Enlarges the picture so that the edges are outside the visible display area.
<b>Horizontal Center</b>	Allows you to move the position of the picture left and right. (Available in <b>Wide Zoom</b> and <b>Zoom</b> .)
<b>Vertical Center</b>	Allows you to move the position of the picture up and down. (Available in <b>Wide Zoom</b> and <b>Zoom</b> .)



- **Normal** is not available when you are watching a 720p, 1080i or 1080p source.
- If **4:3 Default** is set to anything but **Off**, the **Wide Mode** setting changes only for the current channel. When you change channels (or inputs), **Wide Mode** is automatically replaced with the **4:3 Default** setting for 4:3 sources. To retain the current **Wide Mode** setting as channels and inputs are changed, set **4:3 Default** to **Off**.
- **4:3 Default** is not available if **Auto Wide** is set to **Off**.

<i>Option</i>	<i>Description</i>						
<b>PC Settings</b>	When a PC is connected to the TV and the PC input is selected, the <b>PC</b> settings screen appears instead of the <b>Screen</b> settings. You can also select the <b>PIP</b> feature which allows you to view two pictures simultaneously from <b>TOOLS</b> button (see page 26).						
<b>Wide Mode</b>	<table border="1"> <tbody> <tr> <td><b>Normal</b></td> <td>Select to display in the original image size.</td> </tr> <tr> <td><b>Full 1</b></td> <td>Select to enlarge the picture to fill the display area, keeping its original aspect ratio.</td> </tr> <tr> <td><b>Full 2</b></td> <td>Select to enlarge the picture to fill the display area.</td> </tr> </tbody> </table>	<b>Normal</b>	Select to display in the original image size.	<b>Full 1</b>	Select to enlarge the picture to fill the display area, keeping its original aspect ratio.	<b>Full 2</b>	Select to enlarge the picture to fill the display area.
<b>Normal</b>	Select to display in the original image size.						
<b>Full 1</b>	Select to enlarge the picture to fill the display area, keeping its original aspect ratio.						
<b>Full 2</b>	Select to enlarge the picture to fill the display area.						
<b>Auto Adjustment</b>	Select to automatically adjust the display position and phase of the picture when the TV receives an input signal from the connected PC. Note that <b>Auto Adjustment</b> may not work well with certain input signals. In such cases, manually adjust the options below.						
<b>Phase</b>	Adjust after <b>Pitch</b> to fine tune overall sharpness.						
<b>Pitch</b>	Adjust uneven sharpness on screen.						
<b>Horizontal Center</b>	Allows you to move the position of the picture left and right.						
<b>Vertical Center</b>	Allows you to move the position of the picture up and down.						



- For the PC Input Signal Reference Chart, see page 46.
- **Auto Adjustment, Phase** and **Pitch** are not available with PC signal connected to HDMI input.



# Using the Channel Settings

Option	Description
<b>Favorites</b>	Select favorite channels and external inputs (see page 27).
<b>Signal Type</b>	<b>Cable</b> Select if you are receiving cable channels via Cable TV provider.
	<b>Antenna</b> Select if you are using an antenna.
<b>Auto Program</b>	Automatically sets up the channel list on the TV for all receivable channels.
	<ol style="list-style-type: none"> <li>1 Select <b>Auto Program</b>.</li> <li>2 Select <b>OK</b> to start <b>Auto Program</b>.</li> </ol>
<b>Add Digital Channels</b>	<ol style="list-style-type: none"> <li>1 Select <b>Add Digital Channels</b>.</li> <li>2 Select <b>OK</b> to add digital channels.</li> </ol>
	<p>Allows you to show or hide channels that appear when you use the <b>CH +/-</b> buttons.</p> <ol style="list-style-type: none"> <li>1 Press <b>▲/▼</b> to scroll through the channels until you find the channel you want to show or hide. Then press <b>(+)</b> to select it.</li> <li>2 Press <b>▲/▼</b> to determine if the channel will be shown or hidden. Then press <b>(+)</b> to select it.</li> </ol>
<b>Label Channels</b>	Allows you to assign labels (such as station call letters) to channel numbers.
	<ol style="list-style-type: none"> <li>1 Press <b>▲/▼</b> to scroll through the channel numbers. Then press <b>(+)</b> to select the channel number that you want to assign a label.</li> <li>2 Press <b>▲/▼</b> to scroll through the label characters (A-Z, 0-9, etc.). Press <b>▶</b> to move to the next character. Repeat the previous steps to add up to seven characters to the label. When finished, press <b>(+)</b>.</li> </ol>
<b>Analog Fine Tune</b>	Allows you to fine-tune the selected analog channel manually if you feel that a slight tuning adjustment may improve picture quality. Select <b>Auto</b> to adjust to the most appropriate analog channel.



- You should run **Auto Program** after changing the **Signal Type** setting.
- Running **Auto Program** will clear the **Favorites** list.
- Channels that you set to be hidden can be accessed by the **0-9** and **[•]** buttons.
- You can set channels to be hidden that are automatically set in **Auto Program**.



## Using the Parental Lock Settings

Option	Description
<b>Enter Password</b>	The <b>Parental Lock</b> settings allow you to set up the TV to block programs according to their content and rating levels. Use <b>0-9</b> on the remote control to enter a four-digit password. The first time you create a password, confirm the password by entering it again.
<b>Change Password</b>	Select to change your password.
<b>Country</b>	<b>U.S.A.</b> Select to use U.S.A. ratings (see page 39).
	<b>Canada</b> Select to use Canadian ratings (see page 40).
<b>Rating</b>	<b>Off</b> Turn <b>Parental Lock</b> off. No programs are blocked from viewing.
	<b>Child</b> Maximum ratings permitted are: U.S.: TV-Y, TV-G, G Canada: C, G, TV-Y
	<b>Youth</b> Maximum ratings permitted are: U.S.: TV-PG, PG Canada: C8+, PG, 8 ans+, TV-PG
	<b>Young Adult</b> Maximum ratings permitted are: U.S.: TV-14, PG-13 Canada: 14+, 13 ans+, TV-14
	<b>Custom</b> Select to set ratings manually. U.S.: See page 39 for details. Canada: See page 40 for details.
<b>Downloadable U.S. Rating</b> <i>(Available only in U.S.A. where advanced ratings exist)</i>	<b>Off</b> Turn <b>Downloadable U.S. Rating</b> off. No programs that contain downloadable ratings are blocked from viewing.
	<b>Custom</b> Select to block programs based on downloadable ratings.
	<b>Clear All</b> Select to clear the entire downloadable rating system.
<b>Unrated</b> <i>(Available only when Country is set to U.S.A.)</i>	<b>Allow</b> Allows programs and movies that are broadcasted without a rating.
	<b>Block</b> Blocks all programs and movies that are broadcasted without a rating.
<b>Channel Block</b>	Allows you to block channels regardless of program ratings.
	<b>To View a Blocked Channel</b> Press <b>ENT</b> when tuned to the blocked channel then enter the password.
<b>External Input Block</b>	Allows you to block external inputs regardless of program ratings.
	<b>To View a Blocked External Input</b> Press <b>ENT</b> when tuned to the blocked input then enter the password.



- You need your password for any future access into the **Parental Lock** settings. If you lose your password, see “Lost password” on page 55.
- Selecting **Clear All** will delete the current **Downloadable U.S. Rating** menu and the menu will no longer be available until the TV is tuned to a channel that contains downloadable ratings.
- If you block unrated TV programs, be aware that the following types of programs may be blocked: programs broadcasted from another country, emergency broadcasts, political programs, sports, news, public service announcements, religious programs and weather.

## US Models: Selecting Custom Parental Lock Rating Options

To select custom rating options for the U.S., select **U.S.A.** in the **Country** setting (see page 38).

<i>Option</i>	<i>Description</i>
<b>Movie Rating</b>	<b>G</b> All children and general audience.
	<b>PG</b> Parental guidance suggested.
	<b>PG-13</b> Parental guidance for children under 13.
	<b>R</b> Restricted viewing, parental guidance is suggested for children under 17.
	<b>NC-17 and X</b> No one 17 or under allowed.
<b>TV Rating</b> <i>Block programs by their rating, content or both</i>	Age-Based Ratings
	<b>TV-Y</b> All children.
	<b>TV-Y7</b> Directed to children age 7 and older.
	<b>TV-G</b> General audience.
	<b>TV-PG</b> Parental guidance suggested.
	<b>TV-14</b> Parents strongly cautioned.
	<b>TV-MA</b> Mature audience only.
	Content-Based Ratings
	<b>FV</b> Fantasy violence.
	<b>D</b> Suggestive dialogue.
	<b>L</b> Strong language.
	<b>S</b> Sexual situations.
	<b>V</b> Violence.



- To ensure maximum blocking capability, set the Age-Based Ratings.

## Canadian Models: Selecting Custom Parental Lock Rating Options

To select custom rating options for Canada, select **Canada** in the **Country** setting (see page 38).

<i>Option</i>	<i>Description</i>
<b>English Rating</b>	<b>C</b> All children.
	<b>C8+</b> Children 8 years and older.
	<b>G</b> General programming.
	<b>PG</b> Parental guidance.
	<b>14+</b> Viewers 14 and older.
	<b>18+</b> Adult programming.
<b>French Rating</b>	<b>G</b> General programming.
	<b>8 ans+</b> Not recommended for young children.
	<b>13 ans+</b> Not recommended for ages under 13.
	<b>16 ans+</b> Not recommended for ages under 16.
<b>18 ans+</b> Programming restricted to adults.	
<b>U.S.A. Rating</b>	See "US Models" on page 39 for details.

### Viewing Blocked Programs

You can view blocked programs by entering your password. Press **ENT** when tuned to a blocked program, then enter the password. This temporarily deactivates the parental control feature. To reactivate the **Parental Lock** settings, turn off the TV. When the TV is turned on again, your **Parental Lock** settings are reactivated.





## Using the Setup Settings

Option	Description							
<b>USB Auto Start</b>	Select <b>On</b> to start photo playback automatically when the TV is turned on and a digital still camera or other device containing photo files is connected to the USB port then turned on.							
<b>Closed Captions (CC)</b>	Allows you to select from several closed caption modes (for programs that are broadcast with closed captioning).							
	<b>CC Display</b>	<table border="0"> <tr> <td><b>On</b></td> <td><b>Closed Captions (CC)</b> is turned on.</td> </tr> <tr> <td><b>Off</b></td> <td><b>Closed Captions (CC)</b> is turned off.</td> </tr> <tr> <td><b>On when Muting</b></td> <td><b>Closed Captions (CC)</b> is turned on when the TV is muted.</td> </tr> </table>	<b>On</b>	<b>Closed Captions (CC)</b> is turned on.	<b>Off</b>	<b>Closed Captions (CC)</b> is turned off.	<b>On when Muting</b>	<b>Closed Captions (CC)</b> is turned on when the TV is muted.
	<b>On</b>	<b>Closed Captions (CC)</b> is turned on.						
	<b>Off</b>	<b>Closed Captions (CC)</b> is turned off.						
<b>On when Muting</b>	<b>Closed Captions (CC)</b> is turned on when the TV is muted.							
<b>Analog CC</b>	Allows you to select basic analog (EIA-608) closed caption options.							
	<table border="0"> <tr> <td><b>CC1, CC2, CC3, CC4</b></td> <td>Displays a printed version of the dialogue or sound effects of a program. (Should be set to <b>CC1</b> for most programs.)</td> </tr> <tr> <td><b>Text1, Text2, Text3, Text4</b></td> <td>Displays network/station information presented using either half or the whole screen (if available).</td> </tr> </table>	<b>CC1, CC2, CC3, CC4</b>	Displays a printed version of the dialogue or sound effects of a program. (Should be set to <b>CC1</b> for most programs.)	<b>Text1, Text2, Text3, Text4</b>	Displays network/station information presented using either half or the whole screen (if available).			
<b>CC1, CC2, CC3, CC4</b>	Displays a printed version of the dialogue or sound effects of a program. (Should be set to <b>CC1</b> for most programs.)							
<b>Text1, Text2, Text3, Text4</b>	Displays network/station information presented using either half or the whole screen (if available).							
<b>Digital CC</b>	When the digital closed caption service is available, select from the <b>Service 1-6</b> or <b>CC1-4</b> .							
<b>Digital CC Options</b>	Allows you to make additional settings for digital closed caption options. Select <b>As Broadcast</b> or <b>Custom</b> . The <b>Custom</b> option is available on the <b>Digital CC</b> setting.							
	<b>Custom</b>	Allows you to customize the following settings:						
	<b>Character Size</b>	Small, Standard, Large						
	<b>Character Style</b>	Style 1-7						
	<b>Character Color</b>	Color 1-8						
	<b>Character Opacity</b>	Solid, Translucent						
	<b>Edge Type</b>	None, Raised, Depressed, Outline, Left Shadow, Right Shadow						
	<b>Edge Color</b>	Color 1-8						
	<b>Background Color</b>	Color 1-8						
	<b>Background Opacity</b>	Solid, Translucent						



- You can turn on **Closed Captions (CC)** options (**On**, **Off** or **On when Muting**) by directly pressing the **CC** button on the remote control.

<b>Option</b>	<b>Description</b>
<b>Sleep Timer</b>	Set the time in minutes ( <b>Off, 15, 30, 45, 60, 90, or 120</b> ) that you would like the TV to remain on before shutting off automatically.
<b>Language</b>	Select to display all on-screen settings in your language of choice: <b>English, Español, Français.</b>
<b>Info Banner</b>	Displays the information related to the input signal you are watching. Select <b>Small</b> to display minimal channel and program title or select <b>Large</b> to display detailed channel and program information along with the TV icon if you are viewing the TV. This information will appear if it is available from the broadcaster. <b>Info Banner</b> appears on the screen each time the channel and external inputs are changed or when <b>DISPLAY</b> on the remote control is pressed.
<b>Label Video Inputs</b>	Allows you to identify A/V equipment you connected to the TV, such as a VCR, DVD, etc. For example, if you have a DVD player connected to the COMPONENT IN jack, you can select the label DVD for the Component input. Then when you press <b>INPUT</b> to change inputs, the video label you assigned to that input appears on screen. <b>1</b> Press <b>▲/▼</b> to highlight the video input ( <b>HDMI 1-4, Video 1-2, Component 1-2, PC</b> ) to which you want to assign a label. Then press <b>+</b> to select the input. <b>2</b> Press <b>▲/▼</b> to highlight one of the displayed labels. Then press <b>+</b> to select the label.
<b>Video/Component 1 Selection</b>	Select <b>Auto</b> to have the TV detect and switch between the <b>Video 1</b> or <b>Component 1</b> when <b>Video 1</b> or <b>Component 1</b> is connected.



- You can assign following labels for each input:  
–, **Cable, Receiver, Satellite, VCR, DVD/BD, DVR, Audio System, Home Theater, Game, Camcorder, Digital Camera, PC, Edit, Skip** (except PC IN)  
–, **Edit, Skip** (for PC IN)
- “–” indicates that no labels are assigned.
- If you select **Edit**, you can edit video labels. Follow the same steps of **Label Channels** on page 37.
- If you select **Skip**, your TV skips this input when you press the **INPUT** button.
- The Skip label is useful for inputs to which no equipment is connected.

Option	Description
<b>HDMI Settings</b>	Communicates with equipment compatible with the <b>Control for HDMI</b> function.
<b>Control for HDMI</b>	Links the operations of the TV and the equipment. For specific Sony equipment compatible with <b>Control for HDMI</b> , this setting is applied automatically to the connected equipment when set to <b>On</b> .
<b>Device Auto Power Off</b>	Select <b>On</b> to have your connected equipment with <b>Control for HDMI</b> function to power off automatically when the TV is turned off. Select <b>Off</b> to disable this function. This feature is available when <b>Control for HDMI</b> is <b>On</b> .
<b>TV Auto Power On</b>	Select <b>On</b> to control your TV's power on from your connected equipment with <b>Control for HDMI</b> function. Select <b>Off</b> to disable this function. This feature is available when <b>Control for HDMI</b> is <b>On</b> .
<b>Device List</b>	Displays a list of equipment with <b>Control for HDMI</b> function connected to the TV.
<b>Device Control Keys</b>	<p>Select button functions of the TV's remote control to operate the connected equipment.</p> <p><b>None</b> For basic operations, such as navigation buttons (up, down, left or right, etc).</p> <p><b>Tuning Keys</b> For basic operations and operation of channel-related buttons, such as <b>CH +/-</b> or <b>0-9</b>, etc. Useful when you control a tuner or set-top box, etc; via the remote control.</p> <p><b>Menu Keys</b> For basic operations and operation of the <b>MENU/TOOLS</b> buttons. Useful when you select menus of a BD player, etc; via the remote control.</p> <p><b>Tuning and Menu Keys</b> For basic operations and operation of channel-related buttons and <b>MENU/TOOLS</b> buttons.</p>
<ul style="list-style-type: none"> <li>• Press <b>TOOLS</b> while the equipment supporting <b>Control for HDMI</b> is connected to display the <b>Device Control</b> options. The <b>Device Control</b> option provides access to the <b>Menu, Options</b> and <b>Content List</b> of your connected equipment with your TV remote control.</li> <li>• Some equipment with <b>Control for HDMI</b> does not support the <b>Device Control</b> feature.</li> <li>• <b>HDMI Settings</b> must be made on the connected equipment.</li> </ul>	
<b>Picture Adjustments Lock</b>	Select <b>Lock</b> so no adjustment can be made to items grayed out. Select <b>Unlock</b> to allow adjustment to any of the <b>Picture</b> settings.
<b>Product Support</b>	<b>Contact Sony</b> Sony contact information is available on this screen for your convenience. TV specific information such as Model Name, Serial Number, Software Version and downloadable ratings (if available from the TV) are displayed here.
<b>Signal Diagnostics</b>	Press to display the diagnostics information for the current signal.

<i>Option</i>	<i>Description</i>
<b>Initial Setup</b>	If you missed the <b>Initial Setup</b> when you first connected the TV or if you want to scan all receivable channels, select <b>Initial Setup</b> . Follow the instructions on the screen. Some settings such as <b>Picture</b> , <b>Sound</b> , and <b>Parental Lock</b> will not be affected by this <b>Initial Setup</b> . If you wish to return your TV to factory settings, please see the Troubleshooting section on page 55.

---



- Favorite channel list will be cleared each time you run the **Initial Setup**.



## Using the Eco Settings

<i>Option</i>	<i>Description</i>
<b>Power Saving</b>	Select from <b>Off</b> , <b>Low</b> , <b>High</b> , <b>Picture Off</b> to adjust your TV's power consumption. By selecting the <b>High</b> option, you will reduce the power consumption more than the other available settings. While <b>Picture Off</b> is set, pressing <b>VOL +/-</b> or <b>MUTING</b> buttons will not disable this function. Press other buttons to disable it.
<b>Idle TV Standby</b>	Select to automatically power off the TV after <b>1h</b> , <b>2h</b> , or <b>4h</b> when no buttons are pressed on the remote control or the TV. Select <b>Off</b> to disable this function.
<b>Auto Shut Off</b>	Select <b>On</b> to automatically power off the TV when no input signal is detected for a certain period of time. Select <b>Off</b> to disable this function.

# Other Information

## PC Input Signal Reference Chart for PC and HDMI IN 1/2/3/4

After connecting the PC to the TV, set the output signal from the PC according to the chart below.

For KDL-32EX301/KDL-32FA600 models

Resolution				Horizontal frequency (kHz)	Vertical frequency (Hz)	Standard
Signals	Horizontal (Pixel)	×	Vertical (Line)			
VGA	640	×	480	31.5	60	VGA
SVGA	800	×	600	37.9	60	VESA Guidelines
XGA	1,024	×	768	48.4	60	VESA Guidelines
WXGA	1,280	×	768	47.4	60	VESA
	1,280	×	768	47.8	60	VESA
	1,360	×	768	47.7	60	VESA

For KDL-32EX500/KDL-32EX400 and other KDL-40, 46, 55 and 60 inch models

Resolution				Horizontal frequency (kHz)	Vertical frequency (Hz)	Standard
Signals	Horizontal (Pixel)	×	Vertical (Line)			
VGA	640	×	480	31.5	60	VGA
SVGA	800	×	600	37.9	60	VESA Guidelines
XGA	1,024	×	768	48.4	60	VESA Guidelines
WXGA	1,280	×	768	47.4	60	VESA
	1,280	×	768	47.8	60	VESA
	1,360	×	768	47.7	60	VESA
SXGA	1,280	×	1,024	64.0	60	VESA
HDTV*	1,920	×	1,080	67.5	60	CEA-861*

\* The 1080p timing when applied to the HDMI input will be treated as a video timing and not PC timing. This affects **Picture** settings and **Wide Mode** settings. To view PC content set **Scene Select** to **Graphics**, **Wide Mode** to **Full**, and **Display Area** to **Full Pixel**.



- This TV's PC input does not support Sync on Green or Composite Sync.
- This TV's PC VGA input does not support interlaced signals.
- Your PC must support one of the above PC input signals to display on the television.
- In plug and play, signals with a 60 Hz vertical frequency will be detected automatically. (PC reboot may be necessary.)

## Using a Wall-Mount Bracket

Your TV can be mounted on a wall using a Wall-Mount Bracket (not supplied) out of the box as packaged. Some larger size TV may require removing the Table-Top Stand; refer to the instructions provided with the TV.

Prepare the TV for the Wall-Mount Bracket before making cable connections.

**For product protection and safety reasons, Sony strongly recommends that you use the Wall-Mount Bracket designed for your TV and the installation should be performed by a Sony dealer or licensed contractor.**

- Follow the instruction guide provided with the Wall-Mount Bracket for your model. Sufficient expertise is required in installing this TV, especially to determine the strength of the wall for withstanding the TV's weight.
- Be sure to use the screws supplied with the Wall-Mount Bracket when attaching the mounting hooks to the TV set. (Do not use the screws that are intended for the Table-Top Stand attachment.)

The supplied M6 screws are designed so that they are 8 mm to 12 mm in length when measured from the attaching surface of the mounting hook.

Use of screws other than those supplied with the bracket may result in internal damage to the TV set or cause it to fall, etc.

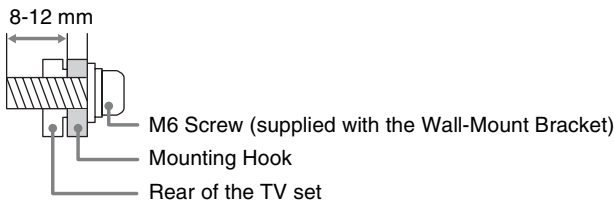

- Be sure to store the unused screws and Table-Top Stand in a safe place until you are ready to attach the Table-Top Stand. Keep the screws away from small children.



- Read the supplied Safety Booklet for additional safety information.

## Installing the Wall-Mount Bracket

### To Customers

Your TV can be wall-mounted using SU-WL500 Wall-Mount Bracket (sold separately).

Please provide this installation information as well as the instruction supplied with SU-WL500 Wall-Mount Bracket to your installer.

### To Sony Dealers and Licensed Contractors

To avoid injury and property damage, read these instructions carefully. Periodic inspection and maintenance is highly recommended to ensure that TV is securely mounted.

## Step 1: Checking the parts required for the installation

Open the Wall-Mount Bracket package and check the contents for all required parts along with the Instructions.

## Step 2: Deciding on the installation location

Decide where you want to install your TV. Refer to the TV installation dimensions table.

**Refer to the Instructions for SU-WL500.**

**Dimension Table**

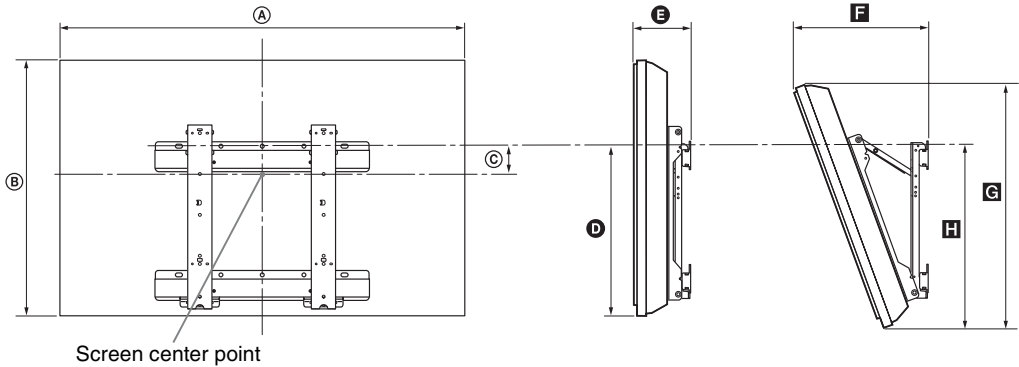

Unit: mm (inches)	TV Dimensions		Screen center dimensions	Length for each mounting angle					Weight	
				Angle (0°)		Angle (20°)				
TV Model	Ⓐ	Ⓑ	Ⓒ	Ⓓ	Ⓔ	Ⓕ	Ⓖ	Ⓗ	TV	×4
KDL-32EX301	800	497	172	426	157	303	470	461	9.5 kg	38.0 kg
KDL-32EX400	(31 1/2)	(19 5/8)	(6 7/8)	(16 7/8)	(6 1/4)	(12)	(18 5/8)	(18 1/4)	(21.0 lb.)	(83.7 lb.)
KDL-32EX500	800	497	172	426	156	303	470	461	9.9 kg	39.6 kg
	(31 1/2)	(19 5/8)	(6 7/8)	(16 7/8)	(6 1/4)	(12)	(18 5/8)	(18 1/4)	(21.9 lb.)	(87.3 lb.)
KDL-32FA600	802	533	172	462	157	303	514	495	10.1 kg	40.4 kg
	(31 5/8)	(21)	(6 7/8)	(18 1/4)	(6 1/4)	(12)	(20 1/4)	(19 1/2)	(22.3 lb.)	(89.1 lb.)
KDL-40EX400	992	598	122	425	160	341	567	463	13.9 kg	55.6 kg
KDL-40EX401	(39 1/8)	(23 5/8)	(4 7/8)	(16 3/4)	(6 3/8)	(13 1/2)	(22 3/8)	(18 1/4)	(30.7 lb.)	(122.5 lb.)
KDL-40EX500	992	599	122	426	159	341	567	463	14.2 kg	56.8 kg
KDL-40EX501	(39 1/8)	(23 5/8)	(4 7/8)	(16 7/8)	(6 3/8)	(13 1/2)	(22 3/8)	(18 1/4)	(31.3 lb.)	(125.2 lb.)
KDL-46EX400	1,127	674	84	424	162	369	640	464	18.1 kg	72.4 kg
KDL-46EX401	(44 3/8)	(26 5/8)	(3 3/8)	(16 3/4)	(6 1/2)	(14 5/8)	(25 1/4)	(18 3/8)	(39.9 lb.)	(159.5 lb.)
KDL-46EX500	1,127	676	84	426	161	369	640	463	18.7 kg	74.8 kg
KDL-46EX501	(44 3/8)	(26 5/8)	(3 3/8)	(16 7/8)	(6 3/8)	(14 5/8)	(25 1/4)	(18 1/4)	(41.2 lb.)	(164.8 lb.)
KDL-55EX500	1,324	795	25	428	165	413	752	466	26.7 kg	106.8 kg
KDL-55EX501	(52 1/4)	(31 3/8)	(1)	(16 7/8)	(6 1/2)	(16 3/8)	(29 5/8)	(18 3/8)	(58.9 lb.)	(235.3 lb.)
KDL-60EX500	1,455	873	-14	430	181	453	822	473	36.5 kg	146.0 kg
	(57 3/8)	(34 3/8)	(-9/16)	(17)	(7 1/4)	(17 7/8)	(32 3/8)	(18 5/8)	(80.4 lb.)	(321.6 lb.)

Figures in the above table may differ slightly depending on the installation.



**CAUTION**

The wall that the TV will be installed on should be capable of supporting a weight of at least four times that of the TV. Refer to your TV’s operating instructions for its weight.

**Step 3: Installing the Base Bracket on the wall**

Refer to the Instructions for SU-WL500.

**Step 4: Preparing the TV for wall mount installation**

Follow the steps below to prepare for installing the TV.

- 1 Disconnect all the cables from the TV.
- 2 Secure the Mounting Hook to the rear of the TV.

Determine the screw locations and secure the Mounting Hooks to the rear of the TV. Refer to the “Screw and Hook Locations Diagram/Table” shown below.

- 1 Secure the Mounting Hooks to the rear of the TV using only the supplied screws (M6 × 16).
- 2 Be sure to tighten the screws with equal torque strength.

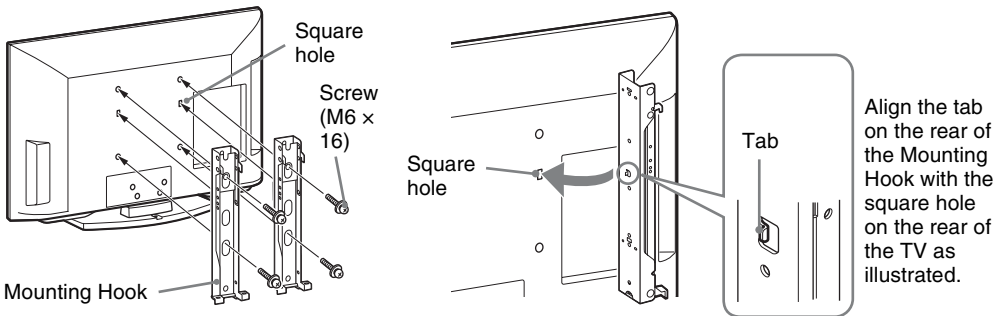

Other Information

**Screw and Hook Locations Diagram/Table**

TV Model	Screw location	Hook location
KDL-32EX301/KDL-32EX400/ KDL-32EX500/KDL-32FA600	e, g	c
KDL-40EX400/KDL-40EX401/ KDL-40EX500/KDL-40EX501	d, g	b
KDL-46EX400/KDL-46EX401/ KDL-46EX500/KDL-46EX501	d, g	b
KDL-55EX500/KDL-55EX501/ KDL-60EX500	d, g	a

### Screw location

When installing the Mounting Hooks on the TV.

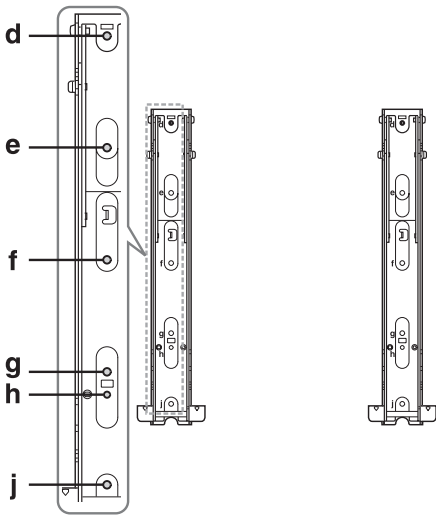

### Hook location

When installing the TV onto Base Bracket.

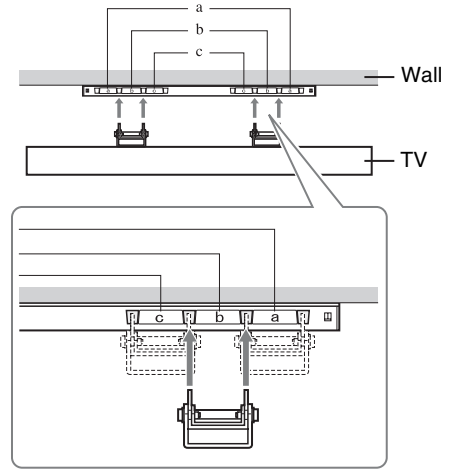

**3** Adjust the angle of the Mounting Hook.

**Refer to the Instructions for SU-WL500.**

**4** Remove the screws guided by the arrow marks  of the TV.

Do not remove any other screws from the TV.

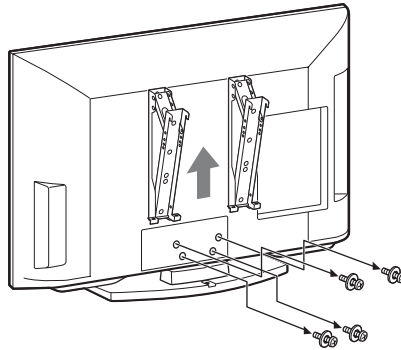

- 5** Lift the TV off the Table-Top Stand. Make sure that you carry out this task with at least two or three people (see page 7 for details).

Do not attempt to lift the TV by yourself.

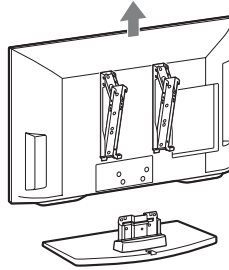

### **Step 5: Installing the TV on the wall**

**Refer to the Instructions for SU-WL500.**



- When you put the TV back on the Table-Top Stand, reverse the above steps.
- When moving the TV, do not squeeze the bottom of the front panel too tight.
- Remove the screws or install the Mounting Hook on a stable and level surface.

# Troubleshooting

Many of the poor pictures and poor sound conditions are related to improper connection of the cables; refer to the Quick Setup Guide provided for connections.

If you have questions, service needs, or require technical assistance related to the use of your Sony TV even after you read this operating instructions manual, contact the following:

## For US Support:

<http://www.sony.com/tvsupport> or call 1-800-222-SONY (7669)

## For Canadian Support:

<http://www.sony.ca/support> or call 1-877-899-SONY (7669)

## Things to consider

- Check the input selection by pressing the **INPUT** button. You may be watching the wrong input.
- If you cannot hear sound from the TV, you may have accidentally pressed the **MUTING** button on your remote control; press the **MUTING** button again or press **VOL +** to deactivate muting.
- If the remote control is not functioning properly, the batteries may be installed incorrectly or may be low or an object or light may be interfering with the remote control.
- To reset the TV to factory default settings:
  - 1 Turn on the TV.
  - 2 Press and hold down the **▲** button on the remote, press the **POWER** button on the TV set. (The TV will turn itself off, then back on again.)
  - 3 Release the **▲** button when the TV is turn on.

**IMPORTANT:** The factory reset will clear all of your customized settings including the **Parental Lock** setting.

When the Password is lost or cannot remember, enter the master password: 4357. This password clears your previous password and allows you to enter a new password.

Condition	Explanation/Solution
<b>No picture</b>	
No picture	• Check the <b>Power Saving</b> settings (see page 45).
Cannot receive any channels	• Make sure the power cord is connected securely. • Turn on the power of the TV. • Check cable/antenna connections. • Make sure the <b>Signal Type</b> setting is correct for your TV signal source.
TV is locked to one channel	• Perform <b>Auto Program</b> to add receivable channels that are not present in the TV's memory (see pages 18 and 37).
Cannot receive or select channels	• Perform <b>Auto Program</b> to add receivable channels that are not present in the TV's memory (see pages 18 and 37). • To receive or select cable channels, make sure that <b>Signal Type</b> in the <b>Channel</b> settings is set to <b>Cable</b> (see page 37). To receive or select UHF channels over an antenna, make sure <b>Signal Type</b> is set to <b>Antenna</b> .
The TV turns off automatically	• Check if <b>Sleep Timer</b> is activated (see page 42). • Check <b>Idle TV Standby</b> in the <b>Eco</b> settings.
No picture from some video sources	• Check the connection between the optional video equipment and the TV. • Press <b>INPUT</b> on the remote control (see page 28).

Condition	Explanation/Solution
<b>Poor picture</b>	
Picture quality not as good as viewed at the store	<ul style="list-style-type: none"> <li>Picture quality depends on the signal content. See Quick Setup Guide (supplied) to display the best possible picture for that signal.</li> </ul>
Broadcast HD formats have poor quality	<ul style="list-style-type: none"> <li>Content and signal quality are regulated by the signal provider. Many HD channels and content are actually upscaled versions of standard-definition broadcasts. The picture is affected by the quality of the signal received, which varies between channel and program.</li> </ul>
Double images or ghosts	<ul style="list-style-type: none"> <li>Check cable/antenna connections.</li> <li>Check the antenna location and direction.</li> </ul>
Only snow and noise appear on the screen	<ul style="list-style-type: none"> <li>Check if the antenna is broken or bent.</li> <li>Check if the antenna has reached the end of its serviceable life. (3-5 years in normal use, 1-2 years at the seaside.)</li> </ul>
Dotted lines or stripes	<ul style="list-style-type: none"> <li>Keep the TV away from noise sources such as cars, motorcycles, or hair-dryers.</li> <li>If using 300 ohm twin lead, move the excess lead away from the TV or try using 75-ohm coaxial cable instead.</li> </ul>
No color / Dark picture / Color is not correct / The picture is too bright	<ul style="list-style-type: none"> <li>Adjust the <b>Picture Mode</b> options in the <b>Picture</b> settings (see page 31).</li> <li>If you set the <b>Power Saving</b> mode to <b>Low</b> or <b>High</b>, it will enhance the black level.</li> </ul>
Noisy picture	<ul style="list-style-type: none"> <li>Make sure that the antenna is connected using a 75-ohm coaxial cable (not supplied).</li> <li>Keep the antenna cable away from other connecting cords.</li> <li>To avoid TV interference, make sure to use an undamaged antenna cable.</li> </ul>
Blurry picture / Poor color	<ul style="list-style-type: none"> <li>Transporting the TV from a cold to a warm location or a sudden change in room temperature may cause moisture condensation, resulting in a blurry picture or poor color. Turn off your TV and wait a few hours before powering on again.</li> </ul>
<b>No sound / Noisy sound</b>	
No sound but good picture	<ul style="list-style-type: none"> <li>Check the volume control.</li> <li>Press <b>MUTING</b> or <b>VOL +</b> so that "Muting" disappears from the screen (page 22).</li> <li>Set <b>Speakers</b> to <b>TV Speakers</b> in the <b>Sound</b> settings (see page 34). If it is set to <b>Audio System</b>, sound is not output from the TV's speakers regardless of the TV's volume control.</li> <li>When using HDMI input with Super Audio CD or DVD-Audio, <b>DIGITAL AUDIO OUT (OPTICAL)</b> may not provide an audio signal.</li> <li>When tuned to a digital channel with <b>Alternate Audio</b>, the broadcaster may not be broadcasting your preferred <b>Alternate Audio</b> language. Press <b>TOOLS</b>, highlight and select <b>Alternate Audio</b>, and change the <b>Alternate Audio</b> language (see page 34).</li> </ul>
Audio noise	<ul style="list-style-type: none"> <li>Make sure that the antenna is connected using a 75-ohm coaxial cable (not supplied).</li> <li>Keep the antenna cable away from other connecting cords.</li> <li>To avoid TV interference, make sure to use an undamaged antenna cable.</li> </ul>
No audio or low audio with Home Theater System	<ul style="list-style-type: none"> <li>Press <b>THEATER</b> for <b>BRAVIA Sync</b> activated Theater System (see page 25).</li> <li>Set <b>Speakers</b> to <b>Audio System</b> in the <b>Sound</b> settings (see page 34).</li> </ul>
No color / Irregular picture	<ul style="list-style-type: none"> <li>Verify that the <b>Video/Component 1 Selection</b> (page 42) is set to the current input type in use. We suggest leaving this setting to <b>Auto</b>.</li> </ul>

Condition	Explanation/Solution
<b>BRAVIA Sync</b>	
Cannot find connected <b>BRAVIA Sync</b> HDMI device	<ul style="list-style-type: none"> <li>Make sure that the <b>Control for HDMI</b> is set up on both the TV and the optional device compatible with <b>BRAVIA Sync</b> (see page 25).</li> </ul>
Second A/V receiver is not listed on the <b>Device List</b>	<ul style="list-style-type: none"> <li>Only one A/V receiver may be used with the <b>BRAVIA Sync</b> and <b>Control for HDMI</b> functions at one time (see page 43).</li> </ul>
<b>PC Input</b>	
No picture / No signal	<ul style="list-style-type: none"> <li>Confirm the PC is correctly connected to the TV with either the PC IN (with an HD15 cable) or with the HDMI IN.</li> <li>Ensure the output signal from the PC is one of the formats listed on page 46.</li> <li>Turn the PC off. Confirm the PC connection and restart the PC. Plug-and-play will auto-detect the TV and correctly set up PC timing.</li> <li>Verify the PC is not in standby or hibernation mode.</li> </ul>
Poor Picture	<ul style="list-style-type: none"> <li>Adjust the resolution (see page 46).</li> <li>Adjust <b>Pitch</b> and <b>Phase</b>.</li> </ul>
<b>General</b>	
TV screen feels warm	<ul style="list-style-type: none"> <li>Due to the thin profile of this television, the heat generated by the LCD panel backlight and supporting electronics will be more noticeable. This is normal operation and not a cause for concern.</li> </ul>
<b>Wide Mode</b> changes automatically	<ul style="list-style-type: none"> <li>The current <b>Wide Mode</b> setting is automatically replaced with the <b>4:3 Default</b> setting when you change the channel or video input, if <b>4:3 Default</b> in the <b>Screen</b> settings is set to other than <b>Off</b>. If you want to lock in <b>Wide Mode</b> selected with <b>WIDE</b> on the remote control, set <b>4:3 Default</b> to <b>Off</b> in the <b>Screen</b> settings (see page 35).</li> <li>Check the <b>Auto Wide</b> option in the <b>Screen</b> settings (see page 35).</li> </ul>
Suddenly the picture gets smaller	<ul style="list-style-type: none"> <li>The picture gets smaller during the commercials due to the method in which the provider broadcasts their content. When HD content channels switch to SD content (commercials), the picture may be small with a black border.</li> <li><b>Auto Wide</b> will not expand the picture during these content changes since the content information is regulated by the channel signal provider. You can manually change the <b>Wide Mode</b> if you prefer (see page 27). This setting will remain in effect until you change the channel or input or manually change the <b>Wide Mode</b> again.</li> </ul>
	
“Black box” on screen	<ul style="list-style-type: none"> <li>You have selected a text option and no text is available (see page 41). To turn off this feature, set the <b>CC Display</b> option to <b>Off</b>. If you were trying to select closed captioning, select <b>CC1</b> instead of <b>Text1-4</b>.</li> </ul>

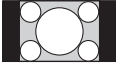
Condition	Explanation/Solution
<p>Black bands appear at the edges of the screen</p> 	<ul style="list-style-type: none"> <li>• Some wide screen programs are filmed in aspect ratios that are greater than 16:9 (this is especially common with theatrical releases). Your TV will show these programs with black bands at the top and bottom of the screen. For more details, check the documentation that came with your DVD/Blu-ray (or contact your program provider).</li> <li>• Programs in 4:3 aspect ratio will have bands on left and right sides of the screen.</li> <li>• Programs broadcast in HD formats (720p and 1080i) with 4:3 content will commonly have black bands on the left and right sides of the screen which are added by the broadcaster (see image on left).</li> <li>• <b>Auto Wide</b> will not expand the picture when the black bands on the sides of the screen are added by the broadcaster. You can manually change the <b>Wide Mode</b> to <b>Wide Zoom</b>, or <b>Zoom</b> to fill the screen, which will remain in affect until you change the channel or input or manually change the <b>Wide Mode</b> again.</li> </ul>
<p>Certain programs on DVD or other digital sources display a loss of detail, especially during fast-motion or dark scenes</p>	<ul style="list-style-type: none"> <li>• This is due to the digital compression of the source content used by certain digital broadcasts and DVDs which may cause your TV's screen to display less detail than usual, or cause artifacts (small blocks or dots, pixelations) to appear on your screen. These signal compressions are more visible and are dependent on the clarity and resolution of the TV.</li> </ul>
<p>Remote control does not operate</p>	<ul style="list-style-type: none"> <li>• To determine if the problem is with the remote control or not, press a button on the TV.</li> <li>• Check the polarity of the batteries or replace the batteries.</li> <li>• Point the remote control at the remote control sensor located at the front of the TV.</li> <li>• Keep the remote control sensor area clear from obstacles.</li> <li>• Fluorescent lamps can interfere with your remote control operation; try turning off the fluorescent lamps.</li> </ul>
<p>Some digital cable channels are not being displayed</p>	<ul style="list-style-type: none"> <li>• Certain cable companies have limitations on the broadcast of digital cable channels. Check with your cable company for more information.</li> <li>• The digital cable channel may be set to <b>Hidden</b> in the <b>Show/Hide Channels</b> setting (see page 37).</li> </ul>
<p>Some photo, music, or video files are not displaying from my USB equipment</p>	<ul style="list-style-type: none"> <li>• The accessible file or folder limit in a directory is 1,000 for USB connected equipment. This limit includes non-supported files or just folders. Files or folders are populated based on their time stamps. Photo, music files or folders exceeding the limit will not be displayed.</li> </ul>
<p>Photo images appear small in the screen</p>	<ul style="list-style-type: none"> <li>• Set display size to expanded.</li> <li>• Whether or not photo images can or cannot be displayed in full-screen depends on the resolution or aspect ratio of the file.</li> </ul>
<p>Photo images or folders take time to display</p>	<ul style="list-style-type: none"> <li>• Depending on the image dimension, file size, and number of files in a folder, some photo images or folders take time to display.</li> <li>• The first time a camera is connected to the TV via USB cable, it may take up to a couple of minutes for the photos to display.</li> </ul>
<p>Lost password</p>	<ul style="list-style-type: none"> <li>• Select the <b>Password</b> settings on the <b>Parental Lock</b> settings, then enter the following master password: 4357. This password clears your previous password and allows you to enter a new password (see page 38).</li> </ul>
<p>How to reset the TV to factory settings</p>	<ul style="list-style-type: none"> <li>• Turn on the TV. While holding down <b>▲</b> on the remote control, press <b>POWER</b> on the TV. (The TV will turn itself off, then back on again.) Release <b>▲</b>.</li> </ul> <p>IMPORTANT: The reset will clear all of your customized settings including the <b>Parental Lock</b> setting.</p>

# Important Notices

## Declaration of Conformity

Trade Name: SONY  
Model: KDL-32/40/46/55/60EX500/  
KDL-40/46/55EX501/KDL-32/40/46EX400/  
KDL-40/46EX401/KDL-32EX301/KDL-32FA600  
Responsible Party: Sony Electronics Inc.  
Address: 16530 Via Esprillo,  
San Diego, CA 92127 U.S.A.  
Telephone Number: 858-942-2230

This device complies with part 15 of the FCC rules.  
Operation is subject to the following two conditions: (1)  
This device may not cause harmful interference, and (2)  
this device must accept any interference received,  
including interference that may cause undesired  
operation.

Pursuant to FCC regulations, you are cautioned that any changes or modifications not expressly approved in this manual could void your authority to operate this equipment.

The shielded interface cable recommended in this manual must be used with this equipment in order to comply with the limits for a digital device pursuant to Subpart B of Part 15 of FCC Rules.

## Compatible Wall-Mount Bracket Information

Use the following Sony Wall-Mount Bracket with your TV model.

	Sony TV Model No.
	KDL-32/40/46/55/60EX500 KDL-40/46/55EX501 KDL-32/40/46EX400 KDL-40/46EX401 KDL-32EX301 KDL-32FA600
Sony Wall-Mount Bracket Model No.	SU-WL500

Use with other Wall-Mount Brackets may cause instability and could result in property damages or injury.

## Note

This television includes a QAM demodulator which should allow you to receive unscrambled digital cable television programming via subscription service to a cable service provider. Availability of digital cable television programming in your area depends on the type of programming and signal provided by your cable service provider.

## For Customers in the United States

The lamp in this product contains mercury. Disposal of these materials may be regulated due to environmental considerations. For disposal or recycling information, please contact your local authorities or the Electronic Industries Alliance ([www.eiae.org](http://www.eiae.org)).

## To Customers

Sufficient expertise is required for TV installations. Be sure to subcontract the installation to a Sony dealer or licensed contractor and pay adequate attention to safety during the installation.

## For customers in Canada

This Class B digital apparatus complies with Canadian ICES-003.

## FCC Related Information

This equipment has been tested and found to comply with the limits for a Class B digital device, pursuant to Part 15 of the FCC Rules. These limits are designed to provide reasonable protection against harmful interference in a residential installation. This equipment generates, uses and can radiate radio frequency energy and, if not installed and used in accordance with the instructions, may cause harmful interference to radio communications. However, there is no guarantee that interference will not occur in a particular installation. If this equipment does cause harmful interference to radio or television reception, which can be determined by turning the equipment off and on, the user is encouraged to try to correct the interference by one or more of the following measures:

- Reorient or relocate the receiving antenna.
- Increase the separation between the equipment and receiver.
- Connect the equipment into an outlet on a circuit different from that to which the receiver is connected.
- Consult the dealer or an experienced radio/TV technician for help.



# Specifications

System	
Television system	NTSC: American TV standard ATSC (8VSB terrestrial): ATSC compliant 8VSB QAM on cable: ANSI/SCTE 07 2000 (Does not include CableCARD functionality)
Channel coverage	Analog terrestrial: 2 - 69 / Digital terrestrial: 2 - 69 Analog Cable: 1 - 135 / Digital Cable: 1 - 135
Panel system	LCD (Liquid Crystal Display) Panel
Speaker output (except KDL-32FA600)	10 W + 10 W
Speaker output (KDL-32FA600 only)	50 W (10 W × 5) + 30 W Subwoofer
Input/Output jacks	
CABLE/ANTENNA	75-ohm external terminal for RF inputs
VIDEO IN 1/2	VIDEO: 1 Vp-p, 75 ohms unbalanced, sync negative AUDIO: 500 mVrms (Typical) / Impedance: 47 kilohms
COMPONENT IN 1/2	YPbPr (Component Video): Y: 1.0 Vp-p, 75 ohms unbalanced, sync negative / PB: 0.7 Vp-p, 75 ohms PR: 0.7 Vp-p, 75 ohms / Signal format: 480i, 480p, 720p, 1080i, 1080p AUDIO: 500 mVrms (Typical) / Impedance: 47 kilohms
HDMI IN 1/2/3/4	HDMI: Video: 480i, 480p, 720p, 1080i, 1080p, 1080/24p Audio: Two channel linear PCM 32, 44.1 and 48 kHz, 16, 20 and 24bits, Dolby Digital PC Input (see page 46)
AUDIO OUT	500 mVrms (typical)
DIGITAL AUDIO OUT (OPTICAL)	PCM/Dolby Digital optical signal
PC IN	D-sub 15-pin, analog RGB, 0.7 Vp-p, 75 ohms, positive See the PC Input Signal Reference Chart for PC and HDMI IN 1/2/3/4 on page 46.
PC/HDMI IN 1 AUDIO INPUT	Stereo mini jack, 500 mVrms, (Typical) / Impedance: 47 kilohms

Model name KDL-	60EX500	55EX500 55EX501	46EX500 46EX501	40EX500 40EX501	32EX500
Power and others					
Power requirement	110-240 V AC, 50/60 Hz (U.S.A./Canada 120 V AC, 60 Hz)				
Power consumption	in use 425 W	315 W	255 W	180 W	140 W
	in standby Less than 0.23 W with 120 V AC and with 240 V AC less than 0.6 W	Less than 0.23 W with 120 V AC and with 240 V AC less than 0.4 W			
Screen size (inches measured diagonally)	60	54.6 (55 class)	46	40	31.5 (32 class)
Display resolution	1,920 dots (horizontal) × 1,080 lines (vertical)				
Speaker/Full range (2) (mm) (inches)	45 × 120 (1 <sup>13</sup> /16 × 4 <sup>3</sup> /4) with speaker box	45 × 200 (1 <sup>13</sup> /16 × 7 <sup>7</sup> /8)	45 × 145 (1 <sup>13</sup> /16 × 5 <sup>3</sup> /4)	45 × 130 (1 <sup>13</sup> /16 × 5 <sup>1</sup> /8)	
Dimensions with stand (mm) (inches)	1,455 × 910 × 386 (57 <sup>3</sup> /8 × 35 <sup>7</sup> /8 × 15 <sup>1</sup> /4)	1,324 × 832 × 350 (52 <sup>1</sup> /4 × 32 <sup>7</sup> /8 × 13 <sup>7</sup> /8)	1,127 × 713 × 281 (44 <sup>3</sup> /8 × 28 <sup>1</sup> /8 × 11 <sup>1</sup> /8)	992 × 636 × 260 (39 <sup>1</sup> /8 × 25 <sup>1</sup> /8 × 10 <sup>1</sup> /4)	800 × 534 × 250 (31 <sup>1</sup> /2 × 21 <sup>1</sup> /8 × 9 <sup>7</sup> /8)
without stand (mm) (inches)	1,455 × 873 × 119 (57 <sup>3</sup> /8 × 34 <sup>3</sup> /8 × 4 <sup>3</sup> /4)	1,324 × 795 × 105 (52 <sup>1</sup> /4 × 31 <sup>3</sup> /8 × 4 <sup>1</sup> /8)	1,127 × 676 × 101 (44 <sup>3</sup> /8 × 26 <sup>5</sup> /8 × 4)	992 × 599 × 99 (39 <sup>1</sup> /8 × 23 <sup>5</sup> /8 × 4)	800 × 497 × 96 (31 <sup>1</sup> /2 × 19 <sup>5</sup> /8 × 3 <sup>7</sup> /8)
wall-mount hole pattern (mm)	400 × 300		300 × 300		200 × 200
wall-mount screw size (mm)	M6 (length: refer to diagram on page 47)				
Mass with stand (kg) (lb.)	43.0 (94.8)	30.7 (67.7)	21.6 (47.6)	16.4 (36.2)	11.9 (26.3)
without stand (kg) (lb.)	36.5 (80.4)	26.7 (58.9)	18.7 (41.2)	14.2 (31.3)	9.9 (21.9)

Model name KDL-	60EX500	55EX500 55EX501	46EX500 46EX501	40EX500 40EX501	32EX500
Supplied accessories common to all models	Remote control RM-YD034 (1)/Size AAA batteries (2)/Operating Instructions (1)/Quick Setup Guide (1)/Warranty Card (1)/Safety and Regulatory Booklet (1)/Software License (1)/Stand installation guide (1 except KDL-60EX500)				
individual models	AC power cord (1)	Table-Top Stand (1 set)/AC power cord (1)/Screw (4)		Table-Top Stand (1 set)/Screw (8)	
Optional accessories	Connecting cables / Support Belt Kit / Wall-Mount Bracket: SU-WL500				

Model name KDL-	46EX400 46EX401	40EX400 40EX401	32EX400	32EX301	32FA600
<b>Power and others</b>					
Power requirement	110-240 V AC, 50/60 Hz (U.S.A./Canada 120 V AC, 60 Hz)				
Power consumption in use	245 W	170 W	135 W		145 W
in standby	Less than 0.23 W with 120 V AC and with 240 V AC less than 0.4 W				
Screen size (inches measured diagonally)	46	40	31.5 (32 class)		
Display resolution	1,920 dots (horizontal) × 1,080 lines (vertical)			1,366 dots (horizontal) × 768 lines (vertical)	
Speaker/Full range (2) (mm) (inches)	45 × 145 (1 <sup>13</sup> /16 × 5 <sup>3</sup> /4)	45 × 130 (1 <sup>13</sup> /16 × 5 <sup>1</sup> /8)		40 × 100 (1 <sup>5</sup> /8 × 4)	
Dimensions with stand (mm) (inches)	1,127 × 711 × 294 44 <sup>3</sup> /8 × 28 × 11 <sup>5</sup> /8	992 × 635 × 250 39 <sup>1</sup> /8 × 25 × 9 <sup>7</sup> /8	800 × 532 × 220 31 <sup>1</sup> /2 × 21 × 8 <sup>3</sup> /4		802 × 570 × 251 31 <sup>5</sup> /8 × 22 <sup>1</sup> /2 × 10
without stand (mm) (inches)	1,127 × 674 × 102 44 <sup>3</sup> /8 × 26 <sup>5</sup> /8 × 4 <sup>1</sup> /8	992 × 598 × 100 39 <sup>1</sup> /8 × 23 <sup>5</sup> /8 × 4	800 × 497 × 97 31 <sup>1</sup> /2 × 19 <sup>5</sup> /8 × 3 <sup>7</sup> /8		802 × 533 × 97 31 <sup>5</sup> /8 × 21 × 3 <sup>7</sup> /8
Satellite Speakers (mm) (inches)	-				150 × 570 × 150 6 × 22 <sup>1</sup> /2 × 6
wall-mount hole pattern (mm)	300 × 300		200 × 200		
wall-mount screw size (mm)	M6 (length: refer to diagram on page 47)				
Mass with stand and Subwoofer (kg) (lb.)	-			13.9 30.7	
with stand (kg) (lb.)	20.4 45.0	15.9 35.1	11.0 24.3		11.8 26.0
without stand (kg) (lb.)	18.1 39.9	13.9 30.7	9.5 21.0		10.1 22.3
Satellite Speakers (kg) (lb.)	-				1.0 2.2
Supplied accessories common to all models	Remote control RM-YD035 (1)/Size AAA batteries (2)/Operating Instructions (1)/Quick Setup Guide (1)/Warranty Card (1)/Safety and Regulatory Booklet (1)/Software License (1)/Stand installation guide (1)/Table-Top Stand (1 set)				
individual models	Screw (4)	Screw (7)			Screw (7)/Speaker cable (3)
Optional accessories	Connecting cables / Support Belt Kit / Wall-Mount Bracket: SU-WL500 / Satellite Speakers Wall-Mount Bracket: WS-WV10D (KDL-32FA600)				

- Optional accessories availability depends on its stock.
- Design and specifications are subject to change without notice.

# Index

0-9 buttons 22  
4:3 Default 35

## A

AC IN 8  
Add Digital Channels 37  
Advanced Settings 32  
Alternate Audio 34  
Ambient Sensor 24, 32  
Analog Fine Tune 37  
AUDIO OUT jack, described 9  
Auto Adjustment 36  
Auto Program 18, 37  
Auto Shut Off 45  
Auto Wide 35

## B

Backlight 31  
Balance 33  
Bass 33  
BRAVIA Sync buttons 20  
Brightness 31

## C

CABLE/ANTENNA input, described 8  
CC button 20  
CH +/- button 22, 24  
Change Password 38  
Channel Block 38  
CineMotion 31  
Closed Captions (CC) 41  
Color 31  
Color Temperature 31  
COMPONENT IN (1080p/1080i/720p/480p/480i) 8  
Country 38

## D

DIGITAL AUDIO OUT (OPTICAL) 8  
Display Area 35  
DISPLAY button 22  
Dolby Pro Logic II 33  
Downloadable U.S. Rating 38

## E

English Rating 40  
ENT button 22  
Enter Password 38  
Equalizer 33  
External Input Block 38

## F

Favorites 37  
FAVORITES button 20  
French Rating 40

## H

HDMI IN jack, described 9

HDMI Settings 43  
Horizontal Center 35, 36  
Hue 31

## I

Idle TV Standby 45  
Info Banner 42  
Infrared Receiver (IR) 24  
Initial Setup 44  
INPUT button 20, 24  
Installing the TV on a wall 47

## J

JUMP button 22

## L

Label Channels 37  
Label Video Inputs 42  
Language 42

## M

MENU button 21, 24  
Motionflow 31  
Movie Rating 39  
MPEG Noise Reduction 31  
MTS Audio 34  
Music 29  
MUTING button 22

## N

Noise Reduction 31

## P

PC IN 9  
PC Settings 36  
Phase 36  
Photo 29  
Picture 31  
Picture Adjustments Lock 43  
Picture Frame 29  
Picture Mode 31  
Picture Off (⊗) LED 24  
PIP 26  
Pitch 36  
POWER (I/⏻) button 22, 23  
POWER (I) LED 24  
POWER button 24  
Power Saving 45  
Product Support 43

## R

Rating 38  
Reset 31, 33, 55  
RETURN button 21

## S

SATELLITE jack 9  
SCENE button 21  
Settings  
Channel 37

Eco 45  
Parental Lock 38  
Picture 31  
Screen 35  
Setup 41  
Sound 33  
Sharpness 31  
Show/Hide Channels 37  
Signal Type 37  
Sleep Timer 42  
Sound Mode 33  
Speaker 24  
Speakers 34  
Standby (⏻) LED 24  
Steady Sound 33  
SUBWOOFER jack 9  
Surround 33

## T

Test Tone 33  
Timer (⌚) LED 24  
TOOLS 22  
Treble 33  
Troubleshooting 52–55  
TV Rating 39

## U

U.S.A. Rating 40  
Unrated 38  
USB 9  
USB Auto Start 41

## V

Vertical Center 35, 36  
Video 29  
VIDEO/AUDIO (L/R) jacks, described 8, 9  
Video/Component 1 Selection 42  
Viewing Blocked Programs 40  
VOL +/- button 22, 24  
Volume Offset 33

## W

WIDE button 22  
Wide Mode 35, 36