



VECTIS

## GX-1/GX-2/GX-3

## E INSTRUCTION MANUAL



Minolta Co., Ltd.  
 Minolta GmbH  
 Minolta France S.A.  
 Minolta (UK) Limited  
 Minolta Austria Ges. m.b.H.  
 Minolta Camera Benelux B.V.  
 Belgium Branch  
 Minolta (Schweiz) AG  
 Minolta Svenska AB  
 Finland Branch  
 Minolta Portugal Limitada  
 Minolta Corporation  
 Head Office  
 Los Angeles Branch  
 Minolta Canada Inc.  
 Head Office  
 Vancouver Branch  
 Minolta Hong Kong Limited  
 Minolta Singapore (Pte) Ltd.  
 Shanghai Minolta Optical  
 Products Co., Ltd.

9222-2281-11 T-B801

3-13, 2-Chome, Azuchi-Machi, Chuo-Ku, Osaka 541-8556, Japan  
 Kurt-Fischer-Strasse 50, D-22923 Ahrensburg, Germany  
 365 Route de Saint-Germain, F-78420 Carrières-Sur-Seine, France  
 Rooksley Park, Precedent Drive, Rooksley, Milton Keynes, MK13 8HF, England  
 Amalienstrasse 59-61, A-1131 Wien, Austria  
 Zonnebaan 39, P.O. Box 6000, NL-3600 HA Maarssen, The Netherlands  
 Kontichsesteenweg 38, B-2630 Aartselaar, Belgium  
 Riedstrasse 6, CH-8953 Dietikon, Switzerland  
 P.O.Box 9058, Albygatan 114, S-17109 Solna, Sweden  
 Niittykatu 6 PL 37, SF-02201 Espoo, Finland  
 Av. do Brasil 33-A, P-1700 Lisboa, Portugal

101 Williams Drive, Ramsey, New Jersey 07446, U.S.A.  
 11150 Hope Street Cypress, CA 90630, U.S.A.

369 Britannia Road East, Mississauga, Ontario L4Z 2H5, Canada  
 230-3771 Jacombs Road, Richmond, B.C. V6V 2L9, Canada  
 Room 208, 2/F, Eastern Center, 1065 King's Road, Quarry Bay, Hong Kong, China  
 10, Teban Gardens Crescent, Singapore 608923

368 Minolta Road, Songjiang, Shanghai, China  
 © 1996 Minolta Co., Ltd. under the Berne Convention and  
 Universal Copyright Convention

## FOR PROPER AND SAFE USE

Read and understand all warnings and cautions before using this product.

**WARNING**

Batteries may become hot or explode due to improper use.

- Use only the batteries specified in this instruction manual.
- Do not install the batteries with the polarity (+/-) reversed.
- Do not subject batteries to fire or high temperatures.
- Do not attempt to recharge, short, or disassemble.
- Tape over lithium battery contacts before disposal. Follow local codes for battery disposal.

Use caution, accidents may occur when using this product near young children.

Keep batteries or things that could be swallowed away from young children. Contact a doctor immediately if an object is swallowed.

Immediately remove the batteries and discontinue use if...

- the camera is dropped or subjected to an impact in which the interior is exposed.
- the product emits a strange smell, heat, or smoke.

Do not disassemble. Electric shock may occur if a high voltage circuit inside the camera is touched. Take your camera to a Minolta Service Facility when repairs are required.

This device complies with Part 15 of the FCC Rules. Operation is subject to the following two conditions: (1) This device may not cause harmful interference, and (2) this device must accept any interference received, including interference that may cause undesired operation. Changes or modifications not approved by the party responsible for compliance could void the user's authority to operate the equipment. This equipment has been tested and found to comply with the limits for a Class B digital device, pursuant to Part 15 of the FCC Rules. These limits are designed to provide reasonable protection against harmful interference in a residential installation. This equipment generates, uses and can radiate radio frequency energy and, if not installed and used in accordance with the instructions, may cause harmful interference to radio communications. However, there is no guarantee that interference will not occur in a particular installation. If this equipment does cause harmful interference to radio or television reception, which can be determined by turning the equipment off and on, the user is encouraged to try to correct the interference by one or more of the following measures:

- Reorient or relocate the receiving antenna.
- Increase the separation between the equipment and the receiver.
- Connect the equipment to an outlet on a circuit different from that to which the receiver is connected.
- Consult the dealer or an experienced radio/TV technician for help.

This Class B digital apparatus meets all requirements of the Canadian Interference-Causing Equipment Regulations.

THIS CAMERA IS SPLASHPROOF AND CAN BE USED IN LIGHT RAIN OR SNOW.

- Do not place the camera under running water or immerse.

Please Note:

1. When using the camera outdoors in heavy rain, keep the camera protected from the rain. Do not leave the camera in the rain.
2. The interior of the camera is not water resistant.
  - Dry the camera before opening the film or battery chambers.
  - When inserting or removing film or batteries, keep your hands dry.
3. Do not load film or replace batteries in places where water, blowing sand, or dust can enter the camera.
4. This camera is not sandproof, do not place the camera directly on the ground.
5. Do not expose the camera to salt water or liquids containing sugar.
6. Close the film and battery chamber covers tightly. Clean the rubber seals before closing covers.
7. If the rubber seals appear cracked or damaged, contact an authorized Minolta Service Facility to have them replaced.
8. Do not subject the camera to shock or impact.

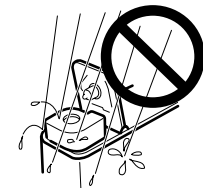
**OPERATING TEMPERATURE AND CONDITIONS**

- This camera is designed for use from -10 to 40°C (14 to 104°F).
- Never leave your camera where it may be subjected to extreme temperatures such as inside the glove compartment of a car.
- At colder temperatures, the data panel response time will be slow. At higher temperatures, the display may temporarily darken, but will restore when the temperature normalizes.
- Never subject the camera to extreme humidity.
- To prevent condensation from forming, place the camera in a sealed plastic bag when bringing it from the cold exterior into a warm building. Allow it to come to room temperature before removing it from the bag.
- When photographing in cold weather, keep the camera and spare batteries inside your coat to keep them warm when you are not shooting. Cold batteries will regain some of their charge when they warm up.

**FILM CASSETTE WARNING**

The film used in Advanced Photo System cameras stores some data magnetically. Do not place the film cassette on or near anything that creates a magnetic field, such as a television or stereo speakers.

**CAMERA ERROR**

If the camera will not function with fresh batteries, remove the batteries, wait a few minutes, then reinsert the batteries. If normal operation does not resume, or the camera malfunctions repeatedly, contact an authorized Minolta Service Facility.

## ATTACHING AND REMOVING THE STRAP

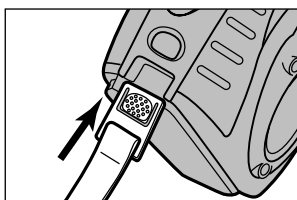

**Attaching**  
 Insert the strap tab into the strap port until it "clicks."

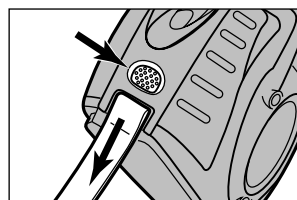

**Removing**  
 Press the strap release and pull the tab out of the strap port.

Thank you for purchasing a Minolta Advanced Photo System™ camera. To take part in your active lifestyle, this camera was designed to be rugged and easy to use. Before using your camera, familiarize yourself with the names and locations of the camera controls and read this manual thoroughly.

\*Advanced Photo System™ is a trademark of the five system developing companies, including Minolta

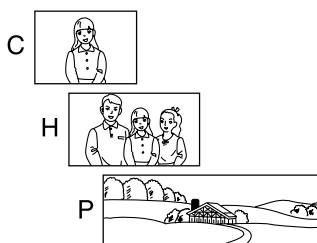

**New print formats...**  
Classic C print, wider H print, and panorama P print formats are available with Advanced Photo System cameras.

**Advantages of the Advanced Photo System**

**Easier to load...**

Advanced Photo System cameras use the new IX240 type film. This new film features drop-in-loading to make loading your camera simple, the first time, every time. Indicators on the cassette tell you and your camera if the film is unexposed, partially exposed, exposed, or processed.

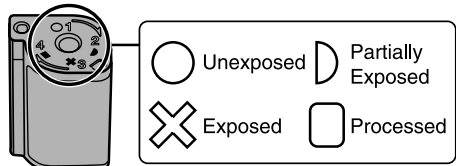

**New processing...**

In addition to returning your prints in the format you selected, certified photofinishers will return your Advanced Photo System film in its original cassette with an index print. To order reprints, simply choose the images you want from the index print. No more searching through negatives to find the right frame.

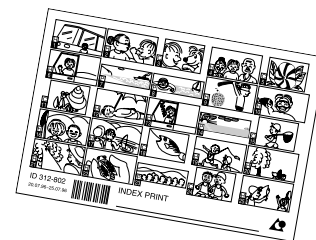

**NAMES OF PARTS**

**Camera Body**

**GX-1**

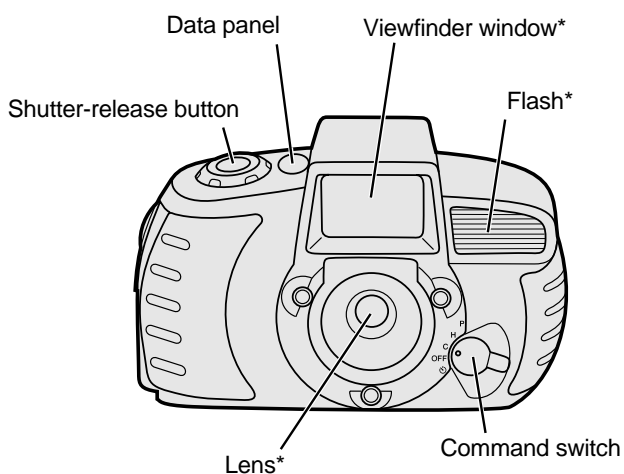

**GX-2**

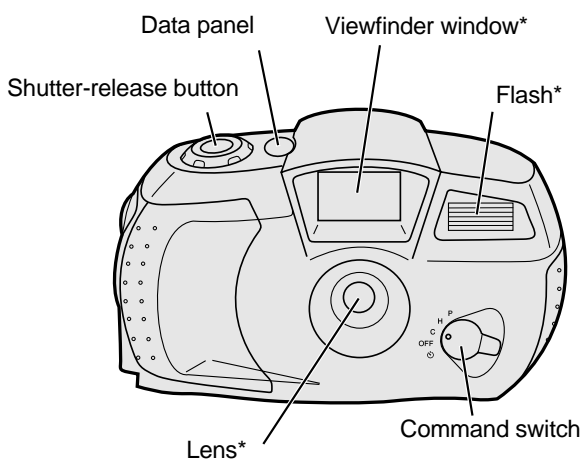

**GX-3**

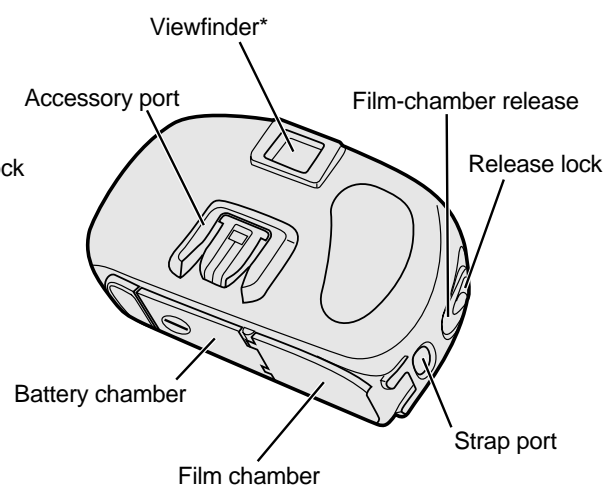
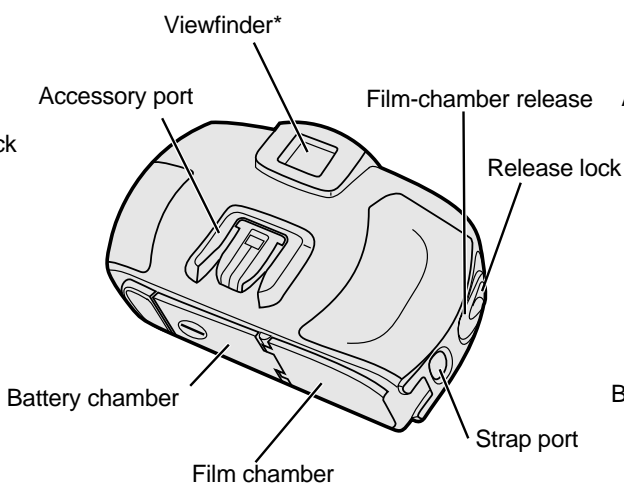
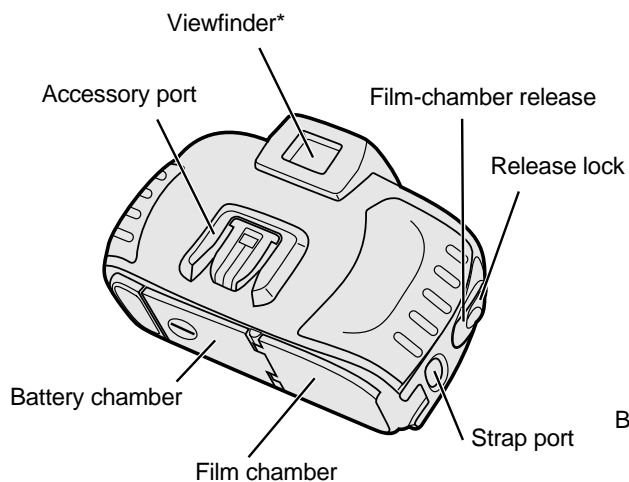
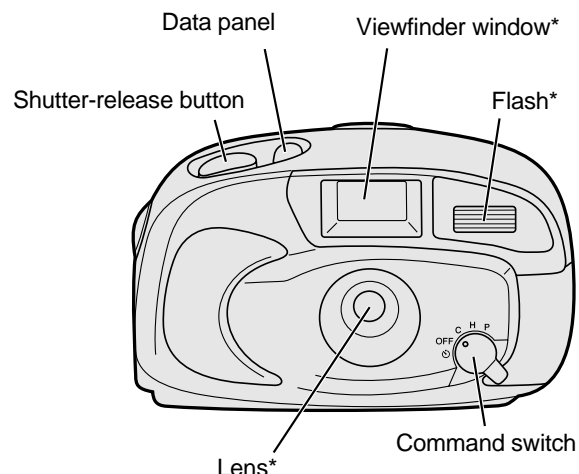

\* Do not touch

**Data Panel**

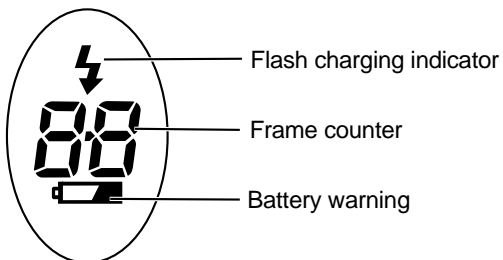

**Command switch**

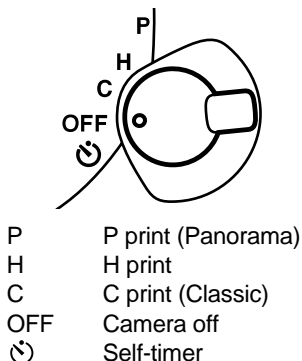

**Image Frames**

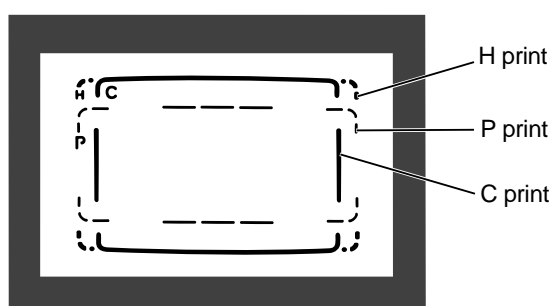

## INSTALLING THE BATTERY

Your camera uses one 3-volt CR2 lithium battery to supply power for all camera operations. Please read the warnings in the Safety Cautions section of this manual as well as those supplied by the battery manufacturer.

- If film is in the camera when the battery is replaced, install a new battery immediately after removing the old battery. If the battery is not replaced immediately, your camera may advance one frame and display - - in the frame counter for the remaining exposures. The frame counter will return to normal operation when a new film cassette is loaded.

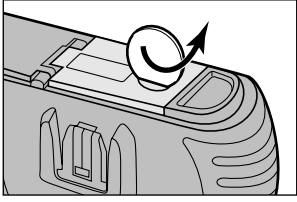

1. Using a coin or similar object, turn the battery-chamber lock to open, then open the battery-chamber door.

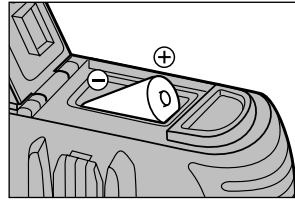

2. Insert a new battery into the chamber as indicated by the + and - marks.
3. Close the battery-chamber door and turn the battery-chamber lock to the close position.
  - Clean the rubber seals and joining surfaces before closing covers.



### Battery Warning Replace the battery.

- If no display appears, replace the battery or make sure it is correctly installed.
- Do not remove the battery unless the battery warning blinks or no display appears in the data panel.
- If the data panel dims after the flash fires, the battery will need to be replaced soon.
- Your camera will shut down if it is not operated for more than three minutes. To restore power, turn the command switch to OFF, then back to P, H, C, or .

## LOADING FILM

Use IX240 (Advanced Photo System) type film in this camera.

- Your camera's transport system loads the film and advances the film after each exposure.
- Do not open the film chamber until 0 appears or all indicators blink in the data panel.
- Install the battery before loading the film, or the film will not advance to the first frame.
- We recommend you use ISO 200 film in this camera.

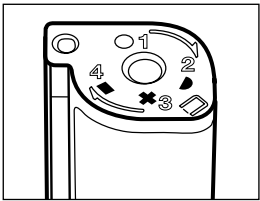

### Visual Exposure Indicators (VEI)

- The current VEI has a white indicator behind it.

VEI	MEANING
●	UNEXPOSED
◐	PARTIALLY EXPOSED
×	EXPOSED
■	PROCESSED

- Your camera can only load unexposed film (●).

### Loading Film

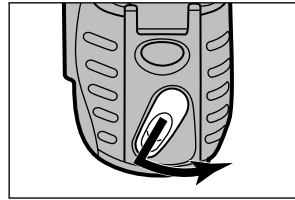

1. Turn the camera upside down, then press the release lock and turn the film-chamber release.

- The film-chamber door will unlock.
- Wipe dirt or moisture off of the camera and film cassette before opening the film chamber.

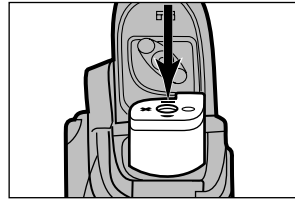

2. Open the film-chamber door and insert a new film cassette into the film chamber.

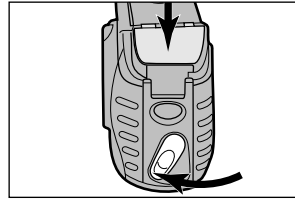

3. Press the film-chamber door closed and turn the film-chamber release to the lock position.

- The film cassette may be damaged if the film-chamber release is moved when the film-chamber door is open.

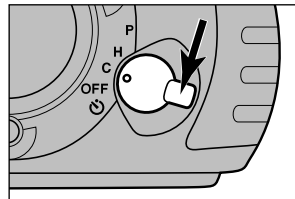

4. Turn the command switch to C, H, or P.

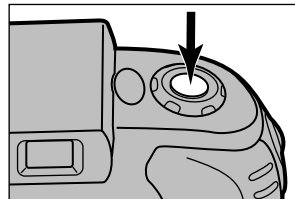

5. Press the shutter-release button.

- The film will advance to the first frame.
- The frame counter displays the number of exposures remaining on the roll.
- If all indicators blink in the data panel, the film has not loaded. Remove and reload the film cassette.

## TAKING PICTURES

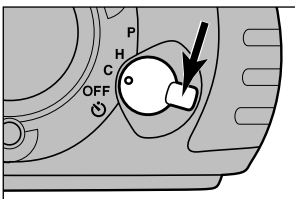

1. Turn the command switch to the desired print format.

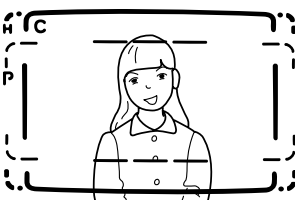

2. Frame your subject(s) in the image frame for the selected print format.

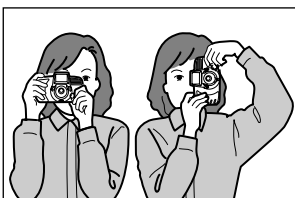

Hold the camera steady, making sure your fingers do not cover the flash. If you are taking a vertically framed picture, turn the camera so the flash is on top.

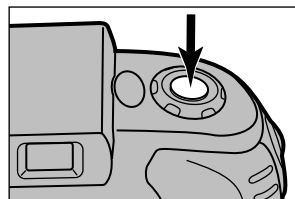

3. Press the shutter-release button to take the picture.

- Keep your subject at least 1.0m (3.3 ft.) from the camera.
- With ISO 200 film, the flash has a range of 1.0 – 3.0m (3.3 – 9.8 ft.) and will fire when necessary.
- You can't take a flash picture when  blinks in the data panel (flash charging).

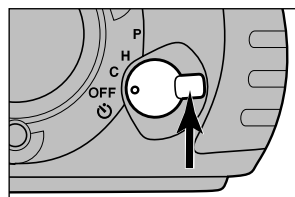

4. Turn the command switch to off when the camera is not in use.



After the last exposure is taken, "0" will appear in the data panel. When the motor stops, open the film chamber and remove the film.

- Remove your film immediately after rewinding. Film left in the camera may reload causing double exposures.

## SELF TIMER

The self-timer delays release of the shutter for approximately ten seconds.

- When the self-timer is selected, the flash will fire every time a picture is taken.
- The print format is set to H when the self-timer is selected.

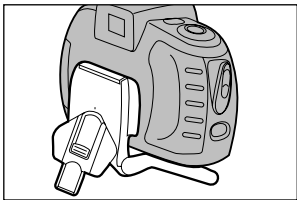

**1. Mount the camera on the Handy Tripod (optional) and place on a level surface.**

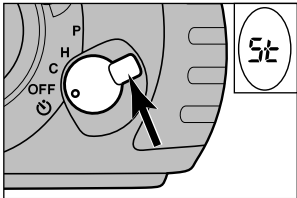

**2. Turn the command switch to .**

- St will appear in the data panel.



**3. Frame your subject(s) inside the H print image frame.**

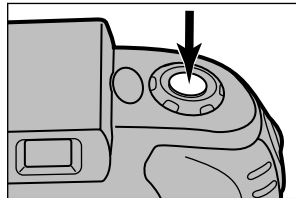

**4. Press the shutter-release button all-the-way down to take the picture.**

- St will blink in the data panel during countdown.

## LAB SERVICES



Take your film to a Certified Advanced Photo System Photofinishing Service to receive the best possible prints. Certified photofinishers will provide the following services when you take your film in for processing.

### 1. CHP - Print Format

Your film will be printed according to the format set when the picture was taken.

### 2. Film is returned in the cassette.

Film will be returned in its original cassette and the VEI set to  to prevent accidental loading.

### 3. Index Print

An index print with a numbered image of each frame is included with your returned order.

## REPRINTS

Images are always captured in the H Print format. However, any of the three formats can be selected when ordering reprints.

## CARING FOR YOUR CAMERA

### Cleaning

- If the camera body is dirty, gently wipe it clean with a soft, dry cloth.
- To clean the lens surface, brush away any dust or sand. If necessary, moisten a lens tissue with lens cleaning fluid and gently wipe the lens in a circular motion.
- Never place lens fluid directly on the lens.
- Never touch the lens surface with your fingers.
- Never use alcohol or solvents to clean the camera.

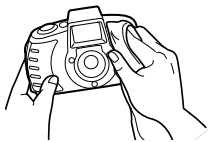

### Storage

When storing the camera for extended periods,

- Store the camera in a cool, dry, well-ventilated area away from dust and chemicals. For longer periods, place the camera in an airtight container with a silica gel drying agent.
- Before using after prolonged storage, check the camera's operation to make sure it's functioning properly.

### Before Important Events

- Check camera operation carefully, or take test photographs.
- Minolta is not responsible for damages incurred by equipment malfunction.

### Questions and Service

- If you have questions about your camera, contact your local camera dealer or write to the Minolta distributor in your area.
- If the camera is damaged or the rewind motor does not operate, do not open the film chamber or forcefully remove the cassette. Contact an authorized Minolta Service Facility.
- Before shipping your camera for repair, contact an authorized Minolta Service Facility for details.

## TECHNICAL DETAILS

<b>Camera Type:</b>	IX240 Lens Shutter Type
<b>Lens:</b>	27mm f/6.4 (approx. equivalent to 34mm in the 35mm format)
<b>Viewfinder Magnification:</b>	0.54X
<b>Focusing:</b>	Fixed 1.0m - ∞ (3.3 ft. - ∞)
<b>Exposure:</b>	Programmed AE
<b>Metering Range (ISO 200):</b>	EV 11 - 15
<b>Flash Range (ISO 200):</b>	1.0 ~ 3.0m (3.3 ~ 9.8 ft.)
<b>Battery:</b>	One CR2 3V lithium battery Battery performance: approximately twenty 25-exposure rolls (Based on Minolta's standard test method with the flash on for 50% of the exposures.)
<b>Splashproof:</b>	IPX4 (Protected against splashing water)

<b>Dimensions:</b>	Vectis GX-1: 120 x 77.5 x 45.5 mm (4.7 x 3.1 x 1.8 in.) Vectis GX-2: 126.5 x 75.5 x 44 mm (5.0 x 3.0 x 1.7 in.) Vectis GX-3: 123.5 x 74 x 46.5 mm (4.9 x 2.9 x 1.8 in.)
<b>Weight (w/o battery):</b>	Vectis GX-1: 220 g (7.76 oz.) Vectis GX-2: 215 g (7.58 oz.) Vectis GX-3: 215 g (7.58 oz.)

Specifications and accessories are based on the latest information available at the time of printing and are subject to change without notice.



This mark on the bottom of your camera is there to inform you that this camera meets the requirements of the EU (European Union) concerning interference causing equipment regulations. CE stands for Conformité Européenne (European Conformity).