

U  
D  
S  
S  
S  
R  
U  
S  
S

FAX-717  
FAX-727  
FAX-737MC

---

brother.

## Available Models for Each country

---

Australia, New Zealand	FAX-727, FAX-737MC
Others	FAX-717, FAX-727, FAX-737MC

THIS EQUIPMENT IS DESIGNED TO WORK WITH A TWO WIRE ANALOGUE PSTN LINE FITTED WITH THE APPROPRIATE CONNECTOR.

## APPROVAL INFORMATION

---

Brother advises that this product may not function correctly in a country other than which it was originally purchased, and does not offer any warranty in the event that this product is used on public telecommunication lines in another country.

# Using This Manual

Thank you for purchasing a Brother fax machine (FAX).

This machine has been designed to be simple to use, with LCD screen prompts to guide you through functions. However, you can use your machine to its fullest potential by taking a few minutes to read this manual.



Additionally, your machine can print a Help List. Make sure that there is no document in the Automatic Document Feeder, and press **Copy/Reports** and press **1** to print a list of basic operational steps and functions.

## Finding Information

---

All chapter headings and subheadings are listed in the Table of Contents. You will be able to find information about a specific feature by checking the Index at the back of this manual. Also, throughout this manual, you will see special symbols alerting you to important information, cross-references, and warnings. Illustrations of some screen displays also help you choose the correct key-presses.

## Symbols Used In This Manual

---



Note or additional information.



The machine would be damaged or would not work correctly if this is not observed.



Warnings detail precautions you must take to avoid possible personal injury.

# User-Friendly Programming

We have designed your fax machine with on-screen programming using navigation keys. User-friendly programming helps you take full advantage of all the functions your machine has to offer. (See *Using This Manual*, page i.)

Because you do all your programming on the LCD, we created step-by-step on-screen prompts to help you program your machine. All you need to do is follow the prompts as they guide you through the function menu selections and programming options and settings.



A complete list of the function selections, options, and settings that are available is provided in the appendix of this manual. (See *Menu Mode & Menu Selection Table*, page 100.)

## Function Mode

---

You can access the Function Mode by pressing **Menu/Set**.

When you enter the Function Mode, your machine displays a list of main menu options from which you can choose. These options appear one after the other on the display. Select an option by pressing **Menu/Set** when the option appears on the LCD.

You can “scroll” more quickly through options by pressing . When the screen displays your selection, press **Menu/Set**. (Use  to scroll backward if you passed your choice or to save key strokes. Both arrow keys show all options, in the opposite order.)

When you finish a function, the screen displays **ACCEPTED**.



If you want to exit the Function Mode, press **Stop/Exit**.

## Alternating Displays

---

The LCD sometimes alternates between the currently selected option, and a help message giving brief instructions about how to proceed. The display you will probably see most often is shown below, showing you that when you place a document in the feeder, you can either dial a number to send it as a fax or press the copy key to make a copy of the document.



# Quick Reference Guide

## Sending Faxes

### Automatic Transmission

- 1 Insert the document face down in the Automatic Document Feeder.
- 2 Enter the fax number you want to call.
- 3 Press **Fax Start**.

## Receiving Faxes





### Select Receive Mode

Press **Receive Mode** to select **FAX ONLY**, **FAX/TEL**, **TAD:ANSWER MACH.** (FAX-717/727) or **MC:MSG CTR** (FAX-737MC) or **MANUAL**. If you select **FAX/TEL**, make sure you set Ring Delay and F/T Ring Time.





## Storing Numbers

### Storing One Touch Dial Numbers

- 1 Press **Menu/Set, 6, 1**.
- 2 Press One Touch key where you want to store a number.
- 3 Enter a number (up to 20 digits), and then press **Menu/Set**.
- 4 Enter a name (or leave it blank), and then press **Menu/Set**.

- 5 Press  or  to select the type of number and press **Menu/Set**.
- 6 Press  or  to select if you set **ANTI JUNK** to **ON** (or **OFF**) and press **Menu/Set**. (Not available in Australia and New Zealand)
- 7 Press **Stop/Exit**.

### Storing Speed Dial Numbers

- 1 Press **Menu/Set, 6, 2**.
- 2 Enter a two-digit Speed Dial number and then press **Menu/Set**.
- 3 Enter a number (up to 20 digits), and then press **Menu/Set**.
- 4 Enter a name (or leave it blank), and then press **Menu/Set**.
- 5 Press  or  to select the type of number and press **Menu/Set**.
- 6 Press  or  to select if you set **ANTI JUNK** to **ON** (or **OFF**) and press **Menu/Set**. (Not available in Australia and New Zealand)
- 7 Press **Stop/Exit**.

## Dialling Operations



### One Touch Dialling

- 1 Insert the document face down in the Automatic Document Feeder.
- 2 Press One Touch key where you want to call.
- 3 Press **Fax Start**.

### Speed Dialling

- 1 Insert the document face down in the Automatic Document Feeder.
- 2 Press **Search/Mute**, then press **#** and the two-digit Speed Dial number.
- 3 Press **Fax Start**.

### Search



- 1 Insert the document face down in the Automatic Document Feeder.
- 2 Press **Search/Mute**, and then enter the first letter of the name you are looking for.
- 3 Press  or  to search the memory.
- 4 Press **Fax Start**, when the LCD shows the name you want to call.

## Making Copies

### Making a Single Copy

- 1 Insert the document face down in the Automatic Document Feeder.
- 2 Press **Copy/Reports** twice.

### Sorting Multiple Copies

- 1 Insert the document face down in the Automatic Document Feeder.
- 2 Press **Copy/Reports**.
- 3 Enter the number of copies you want (up to 99).
- 4 Press **Menu/Set**.
- 5 Press  or  to select **SORT**, and then press **Copy/Reports**.

# Table of Contents

## **PREPARATION AND SIMPLE USE GUIDE**

### **Preparation and Simple Use Guide**

Advice for Preparation and Simple Use Guide .....	4
FAX-717/727 Control Panel Overview .....	8
FAX-737MC Control Panel Overview.....	10

## **BASIC USE**

### **Chapter 1 Setup**

Initial Settings.....	12
Custom Settings.....	14
Melody Settings (Only for FAX-737MC).....	16
Storing Numbers for Easy Dialling .....	17

### **Chapter 2 Sending a Fax**

Scanning Adjustment.....	20
Sending Operation .....	20
Dialling a Number .....	21

### **Chapter 3 Receiving a Fax**

Answer Mode Settings .....	23
Receiving a Fax .....	26

### **Chapter 4 Making Copies**

Copy Functions.....	28
---------------------	----

### **Chapter 5 Telephone**

Making a Call .....	30
Answering a Call .....	32

### **Chapter 6 Printing Reports**

Transmission Report and Journal Setting.....	33
Using the Reports Key.....	34

## **ADVANCED USE**

<b>Chapter 7</b>	<b>Advanced Sending</b>	
	Advanced Operations .....	35
<b>Chapter 8</b>	<b>Advanced Receiving</b>	
	Operation from an External or Extension Telephone .....	44
<b>Chapter 9</b>	<b>Telephone Service</b>	
	Telephone Service for Australia (Telstra® Duet) .....	47
	Telephone Service for New Zealand.....	50
	Telephone Service for Some Countries .....	54
<b>Chapter 10</b>	<b>Polling</b>	
	Polling Receive .....	56
	Polled Transmit.....	58
	Secure Polling .....	59
<b>Chapter 11</b>	<b>Remote Fax Options (Only for FAX-717/727)</b>	
	Fax Forwarding .....	60
	Remote Retrieval .....	61
<b>Chapter 12</b>	<b>Message Centre (Only for FAX-737MC)</b>	
	Message Centre Mode .....	65
	Fax Forwarding/Paging.....	70
	Remote Retrieval .....	72

## **MAINTENANCE**

<b>Chapter 13</b>	<b>Troubleshooting and Maintenance</b>	
	Error Messages .....	77
	Document Jams and Paper Jams .....	79
	Difficulty with Operation.....	81
	Regular Maintenance .....	83
	Packing and Shipping the Machine .....	90

## **IMPORTANT INFORMATION**

<b>Chapter 14</b>	<b>Important Safety Information</b>	
	Important Information for Australia .....	91
	Important Information for New Zealand.....	92
	Important Information for Some Countries .....	95



# **APPENDIX**

## **Chapter 15 Specifications**

Specifications .....	98
Menu Mode & Menu Selection Table .....	100
Entering Text .....	106
About Fax Machines.....	107
Glossary.....	108
Index .....	111
Accessory List .....	114

# Preparation and Simple Use Guide

## Simple steps to prepare and use the machine.

Follow these simple steps to prepare and use the machine.

However, before you perform these steps, refer to the **Important Information** (page 91), and **Advice for Preparation and Simple Use Guide** (page 4).

If you need further information, refer to **BASIC USE** or **ADVANCED USE**.

### 1 Make sure you have the items shown below

Check that you have the following items:

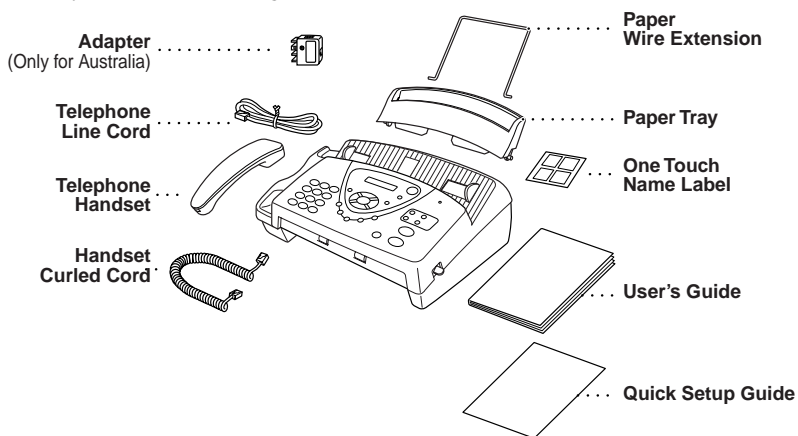

\* The printing cartridge is already installed in the machine.





Keep the packing materials for possible future transport. Failure to pack the machine properly may damage the machine and such damages will not be covered under warranty.

### 2 Read the Quick Setup Guide

Follow the instructions on the Brother Quick Setup Guide to set up the machine.

### 3 Setting the Dialling Mode (Tone/Pulse) (Not available in New Zealand)

- ① Press **Menu/Set**, **1**, **1**. The screen prompts you to select **TONE** or **PULSE**.
- ② Use  or  to select the dialling mode, and press **Menu/Set** when the screen displays the dialling mode you want.
- ③ Press **Stop/Exit**.

### 4 Using the telephone

- ① Pick up the handset.
- ② When you hear a dial tone, dial the number, using the dial pad.
- ③ To hang up, replace the handset on its cradle.

## 5 Setting the Document

- Documents must be between 14.8 and 21.6 cm wide, and 15 and 60 cm long. Your fax machine can only scan an image 20.8 cm wide, regardless of how wide the paper is.
- Make sure you insert documents face down, top edge first.
- Adjust the paper guides to fit the width of your document.

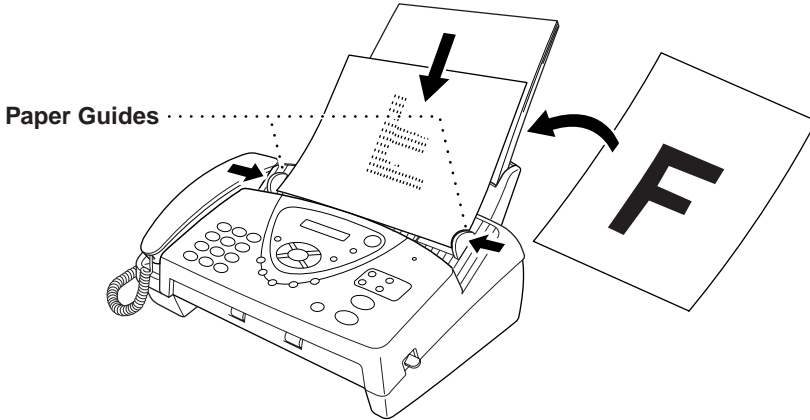

- The Automatic Document Feeder can hold up to 10 pages, feeding each one individually through the fax machine. Use standard (64 gsm-90 gsm) paper when using the Automatic Document Feeder; if you are using heavier paper, feed each sheet individually to prevent paper jams.
- Press **Resolution** (before you send the fax) to select the resolution for the document you are sending. If you wish to send in STANDARD resolution, i.e. a general fax with no graphics, then the default is STANDARD, and the resolution button need not be pressed. (See *Resolution*, page 20.)



- **DO NOT** use, curled, wrinkled paper, folded, ripped paper, or paper with staples, paper clips, paste, or tape attached.
- **DO NOT** use, cardboard, newspaper or fabric.
- **DO NOT** use paper on which correction fluid has been used.
- **Make sure** documents written with ink are completely dry.

## 6 Sending a fax automatically

- ① Insert the document face down in the Automatic Document Feeder.
- ② Enter the fax number you want to call.
- ③ Press **Fax Start**.

**IMPORTANT: Do not pick up the handset.**

## 7 Making a Single Copy









- ① Insert the document face down in the Automatic Document Feeder.
- ② Press **Copy/Reports**.
- ③ Press **Copy/Reports**. (See *Making Copies*, page 28.)  
To cancel, press **Stop/Exit**.

Your machine cannot scan anything closer than 4 mm from the edge of the paper.



**Do NOT pull the paper while copying is in progress.**

## 8 Setting up the Answer phone (MC) (Only for FAX-737MC)

- ① Press **Menu/Set, 8, 1**. The screen prompts you to choose a **DOC** (Document) setting.
- ② Press  or  to select **ON** (or **OFF**), and press **Menu/Set**.  
The screen prompts you to choose a **VOICE** setting.
- ③ Press  or  to select your setting from the list (**ON**, **OFF** or **EXT**), and press **Menu/Set** when the screen displays your selection.
- ④ Press **Stop/Exit**.
- ⑤ Press **Menu/Set, 8, 3**. The screen prompts you to choose an OGM.
- ⑥ Press  or  to reach **MSG CTR OGM**.  
This is the only setting you can select if you want to turn the Message Centre on.
- ⑦ Press **Menu/Set**.
- ⑧ Press  or  to select **RECORD MSG** and press **Menu/Set**.
- ⑨ Pick up the handset to record a message.

**For example:** Hello. We are unable to take your call at this time. Please leave a message after the tone. If you wish to send a fax, please press \* 5 1 (\* 9 1 for New Zealand), wait for the fax tones, then press the start button on your machine. (See *Recording the Message Centre's Outgoing Message (MSG CTR OGM)*, page 66.)

- ⑩ Replace the handset. The Message Centre plays your OGM.
- ⑪ Press **Stop/Exit**.
- ⑫ Activate Message Centre (MC) Mode by pressing .

# ***Advice for Preparation and Simple Use Guide***

## **Packing**

---

Whenever you transport the machine, use the packing materials that came with your machine and pack the machine correctly.

## **Choosing a Location**

---

Place your fax machine on a flat, stable surface, such as a desk. Select a place that is free of vibration and shocks. Locate the machine near a telephone socket and a standard, earthed Mains socket.

Avoid placing your machine in a busy area. Do not place near heaters, air conditioners, water, chemicals or refrigerators. Do not expose the machine to direct sunlight, excessive heat, moisture or dust. Do not connect your machine to electrical outlets controlled by wall switches or automatic timers. Disruption of power can wipe out information in the unit's memory. Do not connect your machine to electrical outlets on the same circuit as large appliances or other equipment that might disrupt the power supply. Avoid connecting the fax machine near to interference sources, such as speakers or the base units of cordless phones.

## **Connecting the Power Cord**

---



- **This fax must be earthed using a 3-pin plug.**
- **Since the machine is earthed through the power outlet, you can protect yourself from potentially hazardous electrical conditions on the telephone network by keeping the power to your machine on when you connect it to a telephone line. Similarly, you can protect yourself when you want to move your machine, by disconnecting the telephone line first, and then the power cord.**
- **Lightning and power surges can damage this product! We recommend that you use a quality surge protection device on the AC power line as well as on the telephone line, or unplug the lines during a lightning storm.**

## **Memory Storage**

---

Your machine is equipped with an internal battery which will keep the date and time information for up to about 48 hours after power has been cut off. After this time, the date and time will be lost and you will have to re-enter the information. In the event of a power failure, all settings in the menus are stored permanently except for the settings that are valid for the next fax only (e.g. contrast, overseas mode).

The FAX-737MC will retain any documents or voice messages stored into the memory for up to 15 hours after a power interruption.

The FAX-717/727 will not retain any documents stored into the memory after a power interruption.

# Connecting an External Telephone Answering Device (TAD)

## Connections

- 1 You may connect an external TAD to your machine, as shown below.

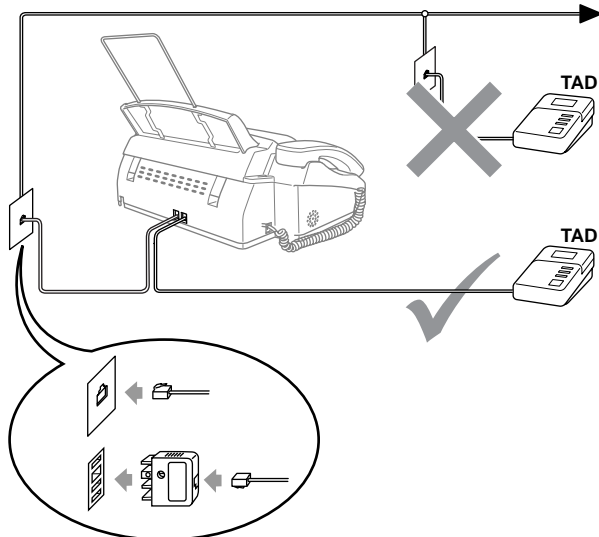

(Example for Australia)

- 2 Set the number of rings to one or two on your external TAD. (The fax machine's Ring Delay setting does not apply.)
- 3 Record the outgoing message on your external TAD (see next page).
- 4 Set the external TAD to answer calls.
- 5 Set **MESSAGE STORE** (Function menu 8-1) to **VOICE:EXT.** (Only for FAX-737MC)
- 6 Set the Answer Mode to **TAD:ANSWER MACH.** (Only for FAX-717/727)  
On FAX-737MC, set the Answer Mode to **MC:MSG CTR.**



**Do not connect a TAD elsewhere on the same phone line—your machine and TAD will both try to control the line.**

## Outgoing Message (OGM) of External TAD

Timing is important in recording this message.

- 1 Record four seconds of silence at the beginning of your message. (This allows your machine time to listen for the fax CNG tones of automatic transmissions before they stop.)
- 2 Try to record the shortest possible message on your telephone answering device (ideally less than 20 seconds).
- 3 End your message by giving your Fax Receive Code for people sending manual faxes. For example:  
“After the beep, leave a message or send a fax manually by pressing \*5 1 (\*9 1 for New Zealand).”

Please note that some faxes that are sent manually cannot be received automatically because some fax machines do not send a fax tone in manual mode. In these cases you must inform callers that they must enter the remote Fax Receive Code to send a fax.

## Sequence of External TAD Reception

When you leave your machine set in TAD mode, all calls will be answered by the externally connected telephone answering device, and fax calls will be received automatically provided they come from a machine which sends standard Calling tone (CNG).

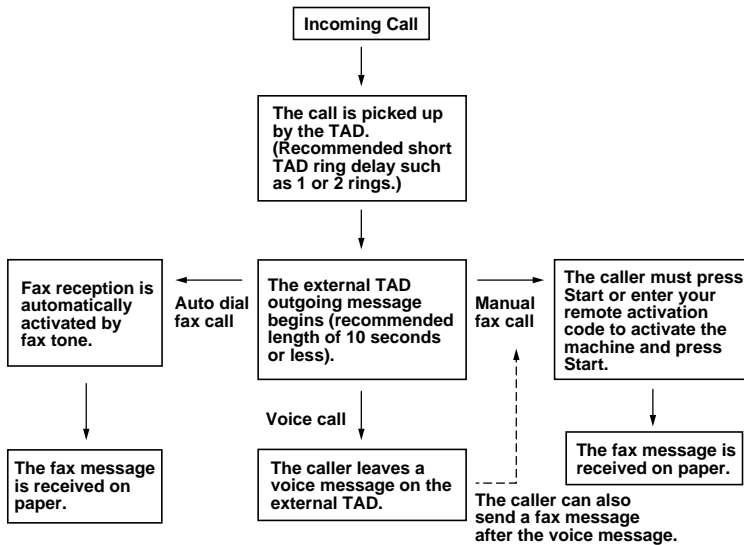

## Connecting an External Telephone

Your machine is equipped with a handset that you can use as a regular phone. However, you can also connect a separate telephone to your machine, as shown below.

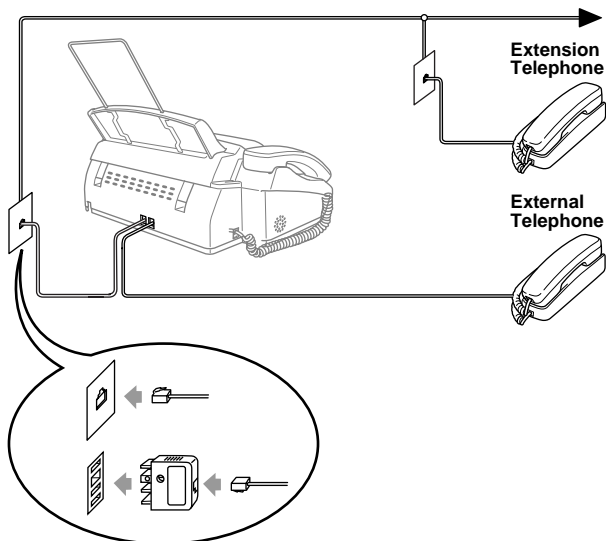

(Example for Australia)

Whenever this external phone (or TAD) is in use, the screen displays **EXT. TEL IN USE**, and, if the fax handset is lifted, an alarm sounds.

To disconnect the call on the external phone and switch to the fax, lift the handset and press **Hook** (FAX-717/727) or **Speaker Phone** (FAX-737MC).



# FAX-717/727 Control Panel Overview

(FAX-727 panel is the same as FAX-717)

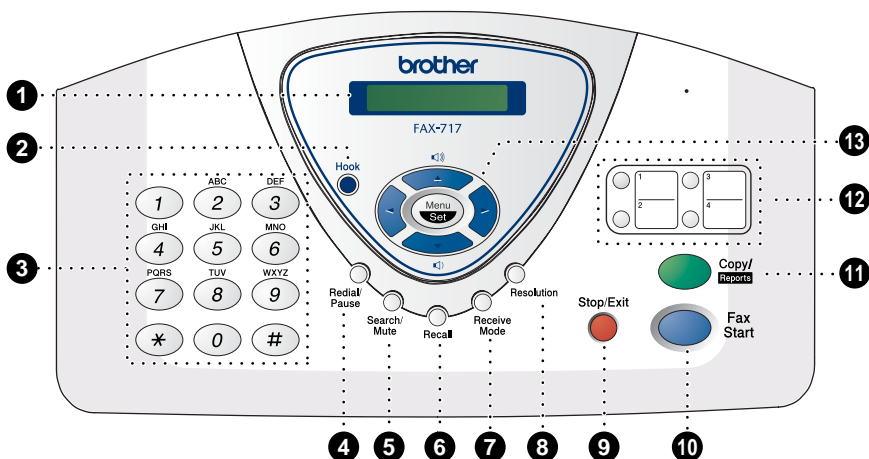

- 1 LCD (Liquid Crystal Display)**  
Displays messages to help you set up and operate your machine.
- 2 Hook**  
Lets you dial telephone and fax numbers without lifting the handset.
- 3 Dial Pad**  
Dials phone and fax numbers and can be used as a keyboard for entering information into the machine.  
# key lets you switch the dialling type during a telephone call from "PULSE" to "TONE". (Not available in New Zealand)
- 4 Redial/Pause**  
Re-dials the last number called. Also inserts a pause in autodial numbers.
- 5 Search/Mute**  
Lets you dial stored phone numbers by pressing # and a two-digit number or lets you look up numbers stored in the dialling memory. Also, lets you put calls on hold.
- 6 Recall**  
Use this key to gain access to an outside line and/or to recall the operator or transfer a call to another extension when it is connected to a PABX. (Australia & New Zealand only)
- 7 Receive Mode**  
Use to select how the machine will handle incoming calls.
- 8 Resolution**  
Sets the resolution when you send a fax or make a copy.
- 9 Stop/Exit**  
Stops a fax, cancels an operation or exits from Menu mode.
- 10 Fax Start**  
Starts an operation, such as sending a fax.
- 11 Copy/Reports**  
With document in the Automatic Document Feeder: Makes a copy.  
Without document in the Automatic Document Feeder: Lets you access the Reports menu so you can select a report to print: **HELP LIST, QUICK-DIAL, FAX JOURNAL, XMIT VERIFY, TEL.INDEX, USER SETTINGS** and **MEMORY STATUS List**.
- 12 One Touch Dial Keys**  
These four keys give you instant access to previously stored phone numbers.

**13 Navigation Keys:  
Menu/Set**

Lets you access the menu and programming mode and stores your settings in the machine.

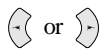

Press to scroll forward or backward to set a menu selection.

You can also use these keys to do an alphabetical search for the names of stored numbers.



Press to scroll through the menus and options.

—**OR**—

You can press these keys to adjust the beeper, ring or speaker volume.

# FAX-737MC Control Panel Overview

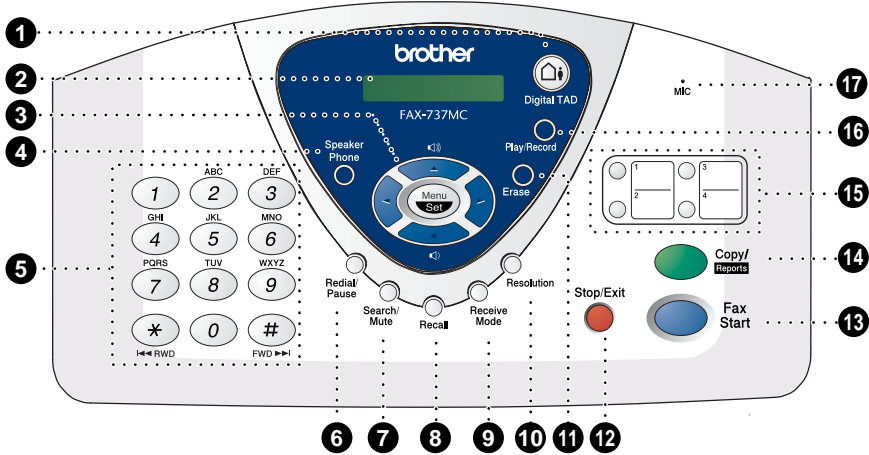

## 1 Digital TAD

Lets you activate Message Centre. Also, notifies you that you have voice or fax messages in the memory.

## 2 LCD (Liquid Crystal Display)

Displays messages to help you set up and operate your machine.

## 3 Navigation Keys: Menu/Set

Lets you access the menu and programming mode and stores your settings in the machine.

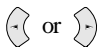

Press to scroll forward or backward to set a menu selection.

You can also use these keys to do an alphabetical search for the names of stored numbers.



Press to scroll through the menus and options.

—OR—

You can press these keys to adjust the beeper, ring or speaker volume.

## 4 Speaker Phone

Lets you speak to the person at the other end and dial telephone and fax numbers without lifting the handset.

## 5 Dial Pad

Dials phone and fax numbers and can be used as a keyboard for entering information into the machine.

# key lets you switch the dialling type during a telephone call from "PULSE" to "TONE". (Not available in New Zealand)

# key also lets you skip to the next message when you are playing voice messages and \* key lets you repeat the last message when you are playing voice messages.

## 6 Redial/Pause

Re-dials the last number called. Also inserts a pause in autodial numbers.

## 7 Search/Mute

Lets you dial stored phone numbers by pressing # and a two-digit number or lets you look up numbers stored in the dialling memory. Also, lets you put calls on hold.

## 8 Recall

Use this key to gain access to an outside line and/or to recall the operator or transfer a call to another extension when it is connected to a PABX. (Australia & New Zealand only)

- 9 Receive Mode**  
Use to select how the machine will handle incoming calls.
- 10 Resolution**  
Sets the resolution when you send a fax or make a copy.
- 11 Erase**  
Lets you delete voice messages, fax messages or all messages.
- 12 Stop/Exit**  
Stops a fax, cancels an operation or exits from Menu mode.
- 13 Fax Start**  
Starts an operation, such as sending a fax.
- 14 Copy/Reports**  
With document in the Automatic Document Feeder: Makes a copy.  
Without document in the Automatic Document Feeder: Lets you access the Reports menu so you can select a report to print: **HELP LIST, QUICK-DIAL, FAX JOURNAL, XMIT VERIFY, TEL.INDEX, USER SETTINGS** and **MEMORY STATUS** List.
- 15 One Touch Dial Keys**  
These four keys give you instant access to previously stored phone numbers.
- 16 Play/Record**  
Lets you listen to voice messages and print fax messages stored in memory. Also, lets you record telephone calls.
- 17 MIC (Microphone)**  
Picks up your voice when you speak to another party using speakerphone.



# 1 Setup

## Initial Settings

### Setting the Dialling Mode (Tone/Pulse) (Not available in New Zealand)

---

Your machine is initially set to **TONE**. If you are using a **PULSE** dial line, you can change the setting to **PULSE** by following the steps below.

- 1 Press **Menu/Set**, **1**, **1**. The screen prompts you to select **TONE** or **PULSE**.
- 2 Use  or  to select the dialling mode, and press **Menu/Set** when the screen displays the dialling mode you want.
- 3 Press **Stop/Exit**.



Although this equipment can use either Pulse or Tone signalling, only the performance of the Tone signalling is subject to regulatory requirements for correct operation. It is therefore strongly recommended that the equipment is set to use the Tone signalling for access to public or private emergency services. The Tone signalling also provides faster call set up.

### Setting the Date and Time

---

The screen displays the date and time you set, whenever the machine is in stand-by mode. *It will* print the date and time on every fax you send.

In the event of a power failure, the machine maintains date and time information for about 48 hours.

- 1 Press **Menu/Set**, **1**, **2**.
- 2 Enter the two digits of the year, and press **Menu/Set**. “04” is registered as 2004 in the machine.
- 3 Enter two digits for the month and press **Menu/Set**.
- 4 Enter two digits for the day and press **Menu/Set**.
- 5 Enter the time in 24 hour format and press **Menu/Set**.
- 6 Press **Stop/Exit**.

## Setting the Station ID

You can store your name, fax number and telephone number in this setting. The name and fax number will be printed on the fax cover pages and all fax pages that you send. (The telephone number will be printed only on your cover pages and on the call back messages.) (See *Electronic Cover Page (Only for FAX-727/737MC)*, page 35 and *Call Reservation (Only for FAX-727/737MC)*, page 38.)

It is important that you enter the fax and telephone numbers in the internationally standardised format, i.e. in accordance with the following strict sequence:

- The “+” (plus) character (by pressing \* key)
- Your Country Code
- Your local area code minus any leading “0”
- A space
- Your number on the local exchange, using spaces to aid readability as appropriate.

**1** Press **Menu/Set, 1, 3**.

**2** Enter your fax number (up to 20 digits) and press **Menu/Set**.

**3** Enter your telephone number (up to 20 digits) and press **Menu/Set**.

**4** Enter your name (up to 20 characters) using the dial pad and the chart. To enter a space press  twice.

**5** Press **Menu/Set**.

**6** Press **Stop/Exit**.



- When you enter your name, see *Entering Text*, page 106.
- The telephone number you enter is used only for the Call Back Message and Cover Page features.
- If you do not enter a fax number, no additional information can be entered.
- To enter a space, press  once between numbers and twice between characters.
- If your Station ID has already been programmed, the screen prompts “1” to make a change, or “2” to exit without changing.



# Custom Settings

## Volume Settings

---



### Beeper Volume

You can set the beeper to **LOW**, **HIGH** or **OFF**. The machine comes set to **LOW**. When the beeper is set to **LOW** or **HIGH**, the machine beeps every time you press a key or make an error, and at the end of sending or receiving a fax.



- 1 Press **Menu/Set, 1, 4**.
- 2 Press  or  to select your setting.
- 3 When the screen displays the setting you want, press **Menu/Set**.
- 4 Press **Stop/Exit**.

### Speaker Volume



You can adjust the speaker volume. If you have FAX-717/727, you must lift the handset, then press **Hook** before you can adjust the volume. If you have FAX-737MC, press **Speaker Phone**.



Press  or  to adjust the volume level. The display shows the setting you are choosing. Each key press changes the volume to the next setting. The new setting will remain until you change it again.



- If you have FAX-737MC, you can adjust the speaker volume while you are listening to your OGM (Outgoing Message) and ICMs (incoming messages).
- If you turn Incoming Recording Monitor to **OFF (Menu/Set, 8, 5)** on FAX-737MC, the Speaker for screening calls will be disabled and you won't hear callers leaving messages. The volume for other operations can still be controlled using  and .

### Ring Volume

You can adjust the ring volume when your fax machine is idle. You can select a ring volume level or press  or  until the ring is off.

Press  or  to adjust the volume level. With each key press, the fax machine rings so you can hear the current setting and the display shows the setting you are choosing. Each key press changes the volume to the next setting. The new setting will remain until you change it again.

## PABX and TRANSFER (Not available for some countries)

Your machine is initially set to be connected with PSTN (Public Switched Telephone Network) lines. However many offices use a central telephone system or Private Automatic Branch Exchange (PABX). Your fax can be connected to most types of PABX. You can gain access to the outside line from your fax connected to PABX by just pressing **Recall**.



You can transfer a call to another extension by pressing **Recall**.



If your machine is connected to a PABX, you may need to insert an additional number prefix (e.g. "9") and a "pause", not press **Recall**, before each fax or telephone number, in order to again access to the outside line.

## Setting PABX

If your machine is connected to a PABX system, set **PBX:ON**. If not, set **OFF**.

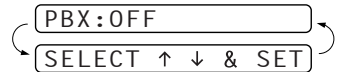
- 1 Press **Menu/Set**, **1**, **5**. The screen displays



- 2 Press  or  to select **ON** (or **OFF**).
- 3 Press **Menu/Set** when the screen displays your selection.
- 4 Press **Stop/Exit**.



You can program an **Recall** keypress as part of a number stored in a One Touch or Speed Dial location. When programming the One Touch or Speed Dial number (Function menu 6-1 or 6-2) press **Recall** first (the screen displays "!"), then enter the telephone number. If you do this, you do not need to press **Recall** each time before you dial using a One Touch or Speed Dial location. (See *Storing Numbers for Easy Dialling*, page 17.) However, if PBX is set to OFF, you can't use the One Touch or Speed Dial number that an **Recall** keypress is programmed into.



# Melody Settings (Only for FAX-737MC)

## Setting the Ring Pattern

You can select a ring pattern from signal (regular ring pattern) or 4 types of melody.

The default setting is **SIGNAL**.

1 Press **Menu/Set, 9, 1**.

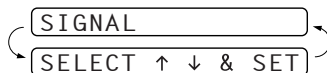

2 Press  or  to select **SIGNAL, MELODY1, MELODY2, MELODY3** or **MELODY4** and press **Menu/Set**.

3 Press **Stop/Exit**.





Even if you select a melody for rings, F/T pseudo-ring can not be changed to the melody.

## Setting the Music on Hold

You can select the music on hold. You can also set the music to **OFF**.

1 Press **Menu/Set, 9, 2**.

2 Press  or  to select **MELODY1, MELODY2, MELODY3, MELODY4** or **OFF** and press **Menu/Set** when the screen displays your selection.

3 Press **Stop/Exit**.



## Setting the Melody Alarm

You can ring the melody at the setting time.

Also, you can select the alarm sound from a signal or 4 types of melody.



1 Press **Menu/Set, 9, 3**.

3.MELODY ALARM

2 Press  or  to select **ON** (or **OFF**) and press **Menu/Set**. If you select **OFF**, go to Step 5.

3 Enter the time in 24-hour format you want to set the alarm and press **Menu/Set**.

SET TIME=10:15

4 Press  or  to select **SIGNAL, MELODY1, MELODY2, MELODY3** or **MELODY4** and press **Menu/Set**.

MELODY1

5 Press **Stop/Exit**.

- ◆ During the Melody Alarm waiting, the screen displays **ALARM WAITING**.
- ◆ Once the melody rings on the time you set, the Melody Alarm setting returns to **OFF**.
- ◆ If the time you set comes during the another operation, the Melody Alarm rings after they are finished.

## Storing Numbers for Easy Dialling

You can set up your machine to do three types of easy dialling:

One Touch, Speed Dial, and Groups for Broadcasting of faxes.

If you use the Caller ID subscriber service offered by your local phone company (For Singapore, Hong Kong and Philippine only), you can register the number for Anti-Junk Fax/Call in One Touch and Speed Dial locations.



If you lose electrical power, auto dial numbers in memory will not be lost.

## Storing One Touch Dial Numbers/Storing Junk Fax/Call Numbers

You can store four fax/phone numbers that you can dial by pressing one key. You can also store names with these numbers. When you press a One Touch dial key, the screen displays the name or number as the call is dialled. (See *One Touch Dialling*, page 21.)



- One Touch keys are not the dial pad keys. They are the four keys (numbers 1–4) located to the right of the navigation keys.
- If you want to store a Junk number, you have to set **ANTI JUNK** to **ON** in Step 6. (Not available in Australia and New Zealand)

- 1 Press **Menu/Set**, **6**, **1**.
- 2 Press the One Touch key where you want to store a number. The screen displays the location you selected.
- 3 Enter a number (up to 20 digits) and press **Menu/Set**.





If you want to enter a pause in the dialling sequence (to wait for an “outside line,” for example), press **Redial/Pause** as you’re entering digits. Pressing **Redial/Pause** enters a 3.5-second pause when the number is dialled, and a dash appears on the screen.

- 4 Use the dial pad to enter the name or company (up to 15 characters) and press **Menu/Set**. You can use the chart to help you enter letters (See *Entering Text*, page 106.)



NAME :

—OR—

To store the number without a name, press **Menu/Set**.

- 5 Press  or  to select the type of number and press **Menu/Set**.

<b>FAX</b>	a fax only number
<b>TEL</b>	a telephone (voice) number
<b>F/T</b>	both a fax and telephone (voice) number

- 6 Press  or  to select if you set **ANTI JUNK** to **ON** (or **OFF**) and press **Menu/Set**. (Not available in Australia and New Zealand)



If you set **ANTI JUNK** to **ON**, the number is registered as the Junk Fax or Call in the machine. The machine will reject receiving the fax message or telephone call. (Not available in Australia and New Zealand)



If you don't use the Caller ID subscriber service offered by your local telephone company, you cannot use the Anti-Junk function. (For Singapore, Hong Kong and Philippine)





- 7 Return to Step 2 to store another One Touch number—**OR**—Press **Stop/Exit** to exit. When you dial a One Touch Dial number, the screen displays the name you have stored, or, if you have not stored a name, the number you have stored.

## Storing Speed Dial Numbers/Storing Junk Fax/Call Numbers

You can store Speed Dial numbers, when you dial by pressing only four keys. There are 100 (FAX-727/737MC) or 60 (FAX-717) Speed Dial locations.





If you want to store a Junk number, you have to set **ANTI JUNK** to **ON** in Step 6. (Not available in Australia and New Zealand)

- 1 Press **Menu/Set**, **6**, **2**. SPEED-DIAL? #
- 2 Use the dial pad to enter a two-digit location and press **Menu/Set**. (00-99 for FAX-727/737MC, 01-60 for FAX-717) #05 :  
ENTER & SET
- 3 Enter the number (up to 20 digits) and press **Menu/Set**. NAME :
- 4 Use the dial pad to enter the name or company (up to 15 characters) (See *Entering Text*, page 106.) and press **Menu/Set**—**OR**—Press **Menu/Set** to store the number without a name.
- 5 Press  or  to select the type of number and press **Menu/Set**.
- |            |   |
|------------|---|
| <b>FAX</b> | a fax only number                       |
| <b>TEL</b> | a telephone (voice) number              |
| <b>F/T</b> | both a fax and telephone (voice) number |
- 6 Press  or  to select if you set **ANTI JUNK** to **ON** (or **OFF**) and press **Menu/Set**. (Not available in Australia and New Zealand)
- 7 Return to Step 2 to store another Speed Dial number—**OR**—Press **Stop/Exit** to exit.

## Changing One Touch and Speed Dial Numbers





If you try to store a One Touch or Speed Dial number in a location where a number is already stored, the screen displays the current name stored there, then prompts you to either

### 1. CHANGE—OR—2. QUIT.

- 1 Press **1** to change the number stored, or press **2** to exit without making a change.
- 2 Enter a new number.
  - ◆ If you want to erase the entire number, press **Stop/Exit** when the cursor is to the left of the digits. The letters above and to the right of the cursor are deleted.
  - ◆ If you want to change a digit, use  or  to position the cursor under the digit you want to change, then type over it.
- 3 Follow the directions from Step 3 in Storing One Touch Numbers or Storing Speed Dial Numbers.

## Setting Up Groups for Broadcasting

Groups allow you to send the same fax message to many fax numbers by pressing only one One Touch key (Broadcasting). **First**, you'll need to store each fax number as a One Touch or Speed Dial number. **Then**, you can combine them into a Group. **Each Group uses up a One Touch key**. **Finally**, you can have up to four small Groups, or you can assign up to 103 (FAX-727/737MC) or 63 (FAX-717) numbers to one large Group. (See *Storing One Touch Dial Numbers/Storing Junk Fax/Call Numbers*, page 17, *Storing Speed Dial Numbers/Storing Junk Fax/Call Numbers*, page 18 and *Broadcasting*, page 22.)

- 1 Press **Menu/Set, 6, 3**. 
- 2 Select a One Touch key where you wish to store the number. (For example, press One Touch key **2** to store a Group.)
- 3 Use the dial pad to enter the Group number and press **Menu/Set**. (For example, press **1** for Group 1.) 
- 4 To include One Touch or Speed Dial numbers in the Group, enter them as if you were dialling. For example, for One Touch key 3, press One Touch key **3**. For Speed Dial location 09, press **Search/Mute**, then press **0, 9** on the dial pad. The LCD shows **\*03, #09**. 
- 5 Press **Menu/Set** to accept the numbers for this group. 
- 6 Use the dial pad to enter a name for the group and press **Menu/Set**. (For example, NEW CLIENTS) (See *Entering Text*, page 106.) 
- 7 Press **Stop/Exit**.



You can print a list of all One Touch and Speed Dial numbers. (See *Printing Reports*, page 33.)

# 2 Sending a Fax

## Scanning Adjustment

### Contrast

If your document is very light or very dark, you might want to set the contrast accordingly. Use **LIGHT** to send a light document. Use **DARK** to send a dark document. After sending the document the contrast setting is set to **AUTO** (suitable for most documents) automatically.

1 Insert the document face down in the Automatic Document Feeder.

2 Press **Menu/Set, 3, 3**.

3 Use  or  to select **AUTO**, **LIGHT**, or **DARK**.

4 When the screen displays your selection, press **Menu/Set**. The screen displays:

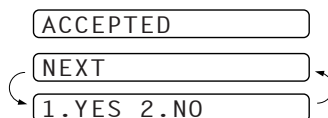

5 Press **2** if you have finished choosing settings, and go to Step 6—**OR**—Press **1** if you want to select additional settings. The display returns to **SETUP SEND** menu.

6 Enter a fax number and press **Fax Start** to send a fax.

### Resolution

When you have a document in the feeder, you can use the **Resolution** key. Press **Resolution** continuously until you see your selection on the screen. If you want to set a different resolution for each page, see *Multiple Resolution Transmission*, page 43.

**STANDARD:** suitable for most typed documents.

**FINE:** good for small print; transmits a little slower than standard resolution.

**S. FINE:** good for small print or artwork; transmits slower than fine resolution.

**PHOTO:** use when document has varying shades of grey; slow transmission time.

## Sending Operation

### Manual Transmission

Manual transmission lets you hear the dial tone, ringing and fax receiving tones before sending the fax.

1 Insert the document face down in the Automatic Document Feeder.

2 Pick up the handset and listen for a dial tone—**OR**—Press **Speaker Phone** (for FAX-737MC only).

3 Enter the fax number you want to call. (See *Dialling a Number*, page 21.)

4 When you hear the fax tone, press **Fax Start**. If you are using the handset, hang up.

## Automatic Transmission

---

This is the easiest way to send a fax.

**IMPORTANT:** Do **not** pick up the handset—**OR**—Press **Speaker Phone** (for FAX-737MC only).

- 1 Insert the document face down in the Automatic Document Feeder.
- 2 Enter the fax number you want to call.
- 3 Press **Fax Start**.

## Dialling a Number

### One Touch Dialling

---

- 1 Insert the document face down in the Automatic Document Feeder.
- 2 Press the One Touch key of the location you want to call.
- 3 Press **Fax Start**.



If you try to use a One Touch or Speed Dial location with no number stored in it, you hear a warning sound, and screen displays **NOT ASSIGNED**. The display returns to normal after 2 seconds.

### Speed Dialling



---

- 1 Insert the document face down in the Automatic Document Feeder.
- 2 Press **Search/Mute**, then press **#** and the two-digit Speed Dial number.
- 3 Press **Fax Start**.

### Search

---

You can search for names you have stored in One Touch and Speed Dial memories. (See *Storing One Touch Dial Numbers/Storing Junk Fax/Call Numbers*, page 17 and *Storing Speed Dial Numbers/Storing Junk Fax/Call Numbers*, page 18.) Names are displayed alphabetically.

- 1 Insert the document face down in the Automatic Document Feeder.
- 2 Press **Search/Mute**.
- 3 To search for numbers alphabetically by name, enter the first letter of the name by using the dial pad, and then press  or .
- 4 When the screen displays the name you want to call, press **Fax Start**.

## Automatic and Manual Fax Redial

---

**Automatic Fax Redial:** If you are sending a fax automatically and the line is busy, the machine will automatically redial up to 3 times at 5 minute intervals.

**Manual Fax Redial:** Place the document to be re-sent and press **Redial/Pause** and then **Fax Start** to make a second call to the last number dialled.

## Broadcasting

---

Using the numbers you have stored in Groups, One Touch and Speed Dial memory, you can “Broadcast” faxes automatically to a maximum of 104 (FAX-727/737MC) or 64 (FAX-717) different locations in a few simple steps.

To Broadcast, you must set Memory TX to either **ON** or **NEXT FAX ONLY**.

After the Broadcast is completed, a Broadcast Report will be printed automatically to let you know the results.

- 1** Insert the document face down in the Automatic Document Feeder.
- 2** Press **Menu/Set, 3, 9** to select **ON** or **NEXT FAX ONLY**.
- 3** Press **Menu/Set**.
- 4** Enter the One Touch and Speed Dial numbers (one after the other), Search numbers or a Group number you have stored.
- 5** Press **Fax Start**. The machine stores the document in memory, and then transmits it to all the numbers you entered. If the line is busy, your machine will redial.



Press **Stop/Exit** during transmission to cancel the current fax Broadcast.  
To cancel all locations, press **Menu/Set, 4**. (See *Cancelling a Scheduled Job*, page 40.)

## Answer Mode Settings

### Select Answer Mode

**MANUAL**—Use this function if you receive many telephone calls and few fax messages. You must answer all calls yourself. If you hear fax tones, wait until the machine takes over the call automatically, then hang up (see Fax Detect function).

**FAX ONLY**—Use this function if you want to receive fax messages only (no telephone calls). The machine automatically answers every call as a fax call. You cannot receive a voice call, but you can dial out and make a voice call.

**FAX/TEL**—Use this function if you expect to receive many fax messages and few phone calls. The machine automatically answers every call. If the call is a fax, it prints the fax. If the call is not a fax, it signals you with an F/T pseudo-ring, different from the phone company ringing, to alert you to pick up the call. If you select this setting, you will need to set the Ring Delay and F/T Ring Time features (on the following pages). (See *For F/T (Fax/Tel) Mode Only*, page 44.)

**TAD:ANSWER MACH.** (FAX-717/727)—This is the only setting in which you can use an **external** answering machine. Your telephone answering device answers every call. Once the external telephone answering device (TAD) answers, the machine listens for fax tones. If it detects fax tones, fax messages are printed.

The TAD setting works only with an external telephone answering device (TAD). Ring Delay and F/T Ring Time do not work in this setting.

**MC:MSG CTR** (FAX-737MC)—FAX-737MC provides you with a built-in digital Message Centre for fax and voice. When you set the machine to answer calls, it will record up to 15 minutes of messages. See *Message Centre (Only for FAX-737MC)*, page 65 for more information.

FAX-717/727



Current Answer Mode

MAN : MANUAL  
 FAX : FAX ONLY  
 F / T : FAX/TEL  
 TAD : ANSWER MACH.  
 (Only for FAX-717/727)

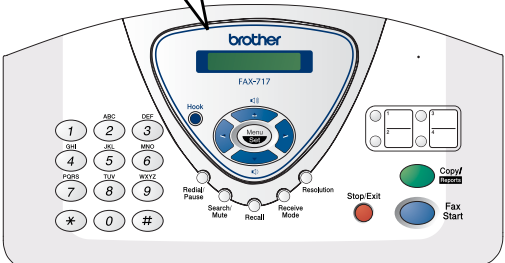

FAX-737MC

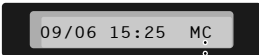

Current Answer Mode

MAN : MANUAL  
 FAX : FAX ONLY  
 F / T : FAX/TEL  
 MC : MSG CTR  
 (Only for FAX-737MC)



Digital TAD



## To select or change your Answer Mode

- 1 Press **Receive Mode**. The screen displays your current selection.

The options on FAX-717/727 are:

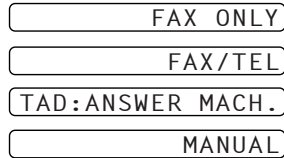

The options on FAX-737MC are:

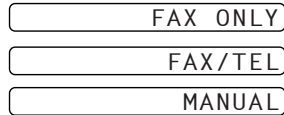

Or, if TAD Mode is switched **ON** by pressing  (Digital TAD button), it overrides your Answer Mode Setting, so the display shows:

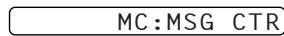





- 2 Continue to press **Receive Mode** until your new selection appears. After 2 seconds, the screen returns to the date and time display, along with your new Answer Mode setting.



If you are changing Answer Mode while in another operation, the screen returns to the current operation display.

## Setting the Ring Delay

The Ring Delay setting determines the number of times the machine rings before it answers. (See *Operation from an External or Extension Telephone*, page 44 and *For F/T (Fax/Tel) Mode Only*, page 44.)



- 1 Press **Menu/Set**, **2**, **1**. If you have a FAX-717/727, go to Step 3.
- 2 Press  or  to select **RING DELAY**, and press **Menu/Set**.
- 3 Press  or  to select how many times the line rings before the machine answers, and press **Menu/Set** when the screen displays your selection.
- 4 Press **Stop/Exit**.



(Only for FAX-737MC)  
When Toll Saver is **ON**, it overrides your Ring Delay setting. Toll Saver must be off for the machine to operate using your Ring Delay setting. (See *Setting the Toll Saver*, page 70.)

## Setting the F/T Ring Time (Only Applies to F/T Receiving Mode)

You need to determine how long the machine will give its special F/T pseudo-ring when you have a voice call. This ringing happens after the initial ringing from the phone company. Only the fax machine rings for 20, 30, 40 or 70 seconds; no other phones (extension or external) on the same line rings during the special F/T pseudo-ring.

- 1 Press **Menu/Set, 2, 2**.
- 2 Press  or  to select how long the machine will ring to alert you that you have a voice call, and press **Menu/Set** when the screen displays your selection.
- 3 Press **Stop/Exit**.



Even if the caller hangs up during the F/T pseudo-ringing, the machine continues the F/T pseudo-ringing for the set time.





Please note that some faxes cannot be received automatically in F/T mode, because some fax machines do not send the standard Group 3 calling tone (“CNG”), but this is not common.



**This machine does not generate F/T ringing tones to any extension telephones. Any such extension telephones will only ring during the period set on ring delay.**

## Recording the Fax/Tel Outgoing Announcement (FAX/TEL OGM) (Only for FAX-737MC)

This is the announcement played by your machine (not an external TAD) when someone calls and your machine is set to F/T mode. Although callers hear your announcement, they cannot leave a message. See *Erasing the Outgoing Message (OGM)*, page 67 for directions to erase the announcement. The purpose of this F/T message is for the callers to better understand the status of their call, when your machine is set in F/T receiving mode. If you want to use Message Centre, you MUST record the Message Centre OGM.

- 1 Press **Menu/Set, 8, 3**. The screen prompts you to choose **FAX/TEL OGM, MSG CTR OGM** or **PAGING OGM**.
- 2 Press  or  to select **FAX/TEL OGM**, and press **Menu/Set**.
- 3 Press  or  to select **RECORD MSG** and press **Menu/Set**, then pick up the handset to record a message.
- 4 Replace the handset. Your announcement is played.
- 5 Press **Stop/Exit**.



It is not necessary to have an outgoing message. The F/T mode will work fine without one. It is only to help the caller understand the status of your machine.

For example, you can leave a message that says:

“Hello, please wait, we are trying to connect you. If you wish to send a fax, please wait until you hear a fax tone and press the Start key, or, press \* 5 1 (\* 9 1 for New Zealand) (your three-digit remote Fax Receive Code) and press the Start key.”

## Fax Detect



---

When you use this feature, you don't have to press **Fax Start** when you answer a fax call and hear calling beeps. Just hold the handset and wait for several seconds. When you see **RECEIVE** on the fax screen or when you hear “chirps” through the handset of an extension phone connected to another wall jack, just replace the handset, and your machine does the rest.

- Selecting **ON** allows the machine to receive fax calls automatically, even if you lift the handset of an extension phone, an external phone, a phone or TAD connected to the machine.
- Selecting **SEMI** lets the fax machine receive the call only if you've answered it at the machine.
- Selecting **OFF** means you will have to activate the machine yourself, by pressing **Fax Start** or by pressing \* 5 1 (\* 9 1 for New Zealand) if you are not at your machine. (See *Operation from an External or Extension Telephone*, page 44 and *For F/T (Fax/Tel) Mode Only*, page 44.)

In case Fax Detect does not work, because of a poor phone line connection, just press **Fax Start** or press the Fax Receive Code \* 5 1 (\* 9 1 for New Zealand). (You have to set Remote Code to **ON** in **Menu/Set, 2, 4** to use \* 5 1 (\* 9 1 for New Zealand).)

**1** Press **Menu/Set, 2, 3**.

**2** Use  or  to select **ON**, **SEMI** or **OFF**, and press **Menu/Set** when the screen displays your selection.

**3** Press **Stop/Exit**.

If you've set the feature to **ON**, but your machine doesn't automatically connect a fax call when you lift an external or extension phone handset, press \* 5 1 (\* 9 1 for New Zealand).

At the machine, lift the handset and press **Fax Start**.

## Receiving a Fax



### Printing a Reduced Incoming Document

---

You can always reduce the size of an incoming fax to a fixed percentage with your machine. If you choose **AUTO**, the machine reduces an incoming document automatically, so that it fits on one page of A4 recording paper, regardless of the size of the original document.

**1** Press **Menu/Set, 2, 5**. The screen displays

5 . REDUCTION

- 2 Use  or  to select the reduction ratio you want—**AUTO**, **100%**, **93%**, **87%**, or **75%**. Choose **100%** if you don't want a reduction.
- 3 Press **Menu/Set** when the screen displays your selection.
- 4 Press **Stop/Exit**.



If you receive faxes that are split on two pages, change the reduction to **AUTO**—**OR**—Choose a lower reduction percentage.



- When you use Auto Reduction to reduce incoming documents to fit on one page of recording paper, you can do so only as long as the original document is not longer than 35 cm. If the original is longer than 35 cm, the data will not be reduced and will carry over to print on a second page.
- When you use Auto Reduction and you receive an incoming document that is smaller than your recording paper, no reduction will take place, and you will get the same size recorded as the original.

## Reception into Memory



As soon as the paper cassette becomes empty or ink ribbon runs out during fax reception, the screen will display **CHECK PAPER**; please put some paper in the paper tray.

### If the MEMORY RECEPTION switch is ON at this time...

The current fax reception will continue, with the remaining page(s) being stored in memory, subject to available memory. Subsequent incoming faxes will also be stored into memory until the memory is full, following which no further incoming fax calls will be automatically answered; all data will be printed as soon as fresh paper is put in the paper cassette.

### If the MEMORY RECEPTION switch is OFF at this time...

The current fax reception will continue, with the remaining page(s) being stored in memory, subject to available memory. Subsequent incoming fax calls will not be automatically answered until fresh paper is put in the paper cassette. The last fax received will be printed as soon as fresh paper is put in the cassette.

- 1 Press **Menu/Set**, **2**, **6**. The screen displays
- 2 Use  or  to select **ON** or **OFF**, and press **Menu/Set** when the screen displays your selection.
- 3 Press **Stop/Exit**.

6 . MEM . RECEIVE

## Printing a Fax from Memory (Only for FAX-717/727)

If you have fax storage ON for remote retrieval, you can still print a fax from the machine's memory when you are at your machine. (See *Setting Fax Storage*, page 60.)

- 1 Press **Menu/Set**, **8**, **4**.
- 2 Press **Fax Start**.
- 3 Press **Stop/Exit**.

# 4 Making Copies

## Copy Functions

To make a single copy that is not reduced, enlarged or sorted, you only have to press one key. Remember, your machine cannot scan anything closer than 4 mm from the edge of the paper.

### Making a Single Copy





- 1 Insert the document face down in the Automatic Document Feeder.
- 2 Press **Copy/Reports** twice.  
To cancel, press **Stop/Exit**.  
Do NOT pull on the paper while copying is in progress.

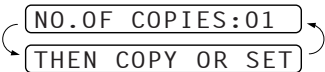

The default resolution for a single copy is **S.FINE**. Set the resolution to **PHOTO** for photographs by using the **Resolution** key.

### Copy Options: Single or Multiple Copies, Sort/Stack, Reduce/Enlarge

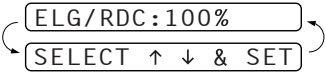
You can choose additional copy options. First, you can select the number of copies. Next, you can choose whether multiple copies will be **STACKED** (all copies of page 1, then all copies of page 2, etc.) or **SORTED** (collated). Finally, you can choose an enlargement or reduction ratio. To automatically reduce the copy to the paper size you have set for the paper tray, select **AUTO**. To reduce the copy by a fixed percentage, choose **93%**, **87%**, **75%** or **50%**. Or, to enlarge the copy, select **150%**, **125%** or **120%**. To copy a document at its original size, select **100%**.

- 1 Insert the document face down in the Automatic Document Feeder.
- 2 Press **Copy/Reports**.  

- 3 Enter the number of copies you want (1-99).  
*To start copying now*, press **Copy/Reports**.  
*If you would like to select additional copy options*, like **SORT**, **ELG/RDC** (Enlarge or Reduce) press **Menu/Set**.
- 4 Press  or  to select **SORT** or **STACK**.  
*To start copying now without enlarging or reducing*, press **Copy/Reports**.  
*To reduce or enlarge the image*, press **Menu/Set**.  

- 5 Press  or  to select an enlargement or reduction ratio.
- 6 Press **Copy/Reports**.



If you are making multiple copies and get a **OUT OF MEMORY** message while you are scanning the first page, press **Stop/Exit** to cancel the job. Then make a single copy. If you selected **Sort** and the **OUT OF MEMORY** message appears while scanning subsequent pages, you can press **Copy/Reports** to copy the portion that is in memory, or press **Stop/Exit** to cancel. To re-start the copy job using less memory, press **Copy/Reports** for stacked copies.



The default resolution for multiple copies or reducing and enlarging copies is **FINE**. Set the resolution to **S.FINE** for small print or artwork and **PHOTO** for photographs by using the **Resolution** key. **S.FINE** and **PHOTO** resolutions use up more memory than **FINE** mode.

# 5 Telephone

## Making a Call

You can use your machine to make voice telephone calls, by dialling manually or by using One Touch or Speed Dial memory. You can use the handset or if you have FAX-737MC you can use the Speakerphone to make and receive calls. For more details, see *Dialling a Number*, page 21.

The “full-duplex” digital Speakerphone allows you to operate the phone hands free, or allows more than one person in the room to participate in a two-way phone conversation. When using the Speakerphone, make sure that you speak clearly. If the other party has difficulty hearing you, move closer to the microphone or use the handset.

## On Hook Dialling

---

- 1 Dial the number by using the dial pad or Quick-Dial keys.  
The number you are dialling, or the name you have stored for One Touch or Speed Dial is displayed on the LCD.
- 2 For FAX-717/727, press **Fax Start** and pick up the handset when you hear the call answered on the monitor speaker. If you press **Hook** before lifting the handset, the call will be disconnected. Replace the handset to finish the call.  
For FAX-737MC, press **Fax Start**, and when the call is answered, you can now speak to the party at the other end without lifting the handset. Press **Speaker Phone** when you finish the conversation.

## One Touch Dialling

---

- 1 Pick up the handset—**OR**—Press **Speaker Phone** (for FAX-737MC only).
- 2 Press the One Touch Dial key of the location you want to call.
- 3 To hang up, replace the handset—**OR**—Press **Speaker Phone** (for FAX-737MC only).



If you try to use a One Touch or Speed Dial location with no number stored in it, you hear a warning sound, and screen displays **NOT ASSIGNED**. The display returns to normal after 2 seconds.

## Speed Dialling



---

- 1 Pick up the handset—**OR**—Press **Speaker Phone** (for FAX-737MC only).
- 2 Press **Search/Mute**, then press **#** and the two-digit Speed Dial number. (See *Storing Speed Dial Numbers/Storing Junk Fax/Call Numbers*, page 18.)
- 3 To hang up, replace the handset—**OR**—Press **Speaker Phone** (for FAX-737MC only).

## Search

---

You can search for names you have stored in One Touch and Speed Dial memories. (See *Storing One Touch Dial Numbers/Storing Junk Fax/Call Numbers*, page 17 and *Storing Speed Dial Numbers/Storing Junk Fax/Call Numbers*, page 18.)

- 1 Pick up the handset—**OR**—Press **Speaker Phone** (for FAX-737MC only).
- 2 Press **Search/Mute**, then enter the first letter of the name you are looking for by using the dial pad.
- 3 Press  or  to search the names that are displayed alphabetically.
- 4 When the screen displays the name you want to call, press **Fax Start** to begin dialling.
- 5 To hang up, replace the handset—**OR**—Press **Speaker Phone** (for FAX-737MC only).

## Redial

---

If you are calling someone and the line is busy, you can retry the number by pressing **Redial/Pause**.

- 1 Pick up the handset—**OR**—Press **Speaker Phone** (for FAX-737MC only).
- 2 Press **Redial/Pause**.
- 3 To hang up, replace the handset—**OR**—Press **Speaker Phone** (for FAX-737MC only).

## Pause

---

Press **Redial/Pause** to insert a pause between digits to be dialled.

If your fax machine is connected to a PABX, you may need to insert an additional number prefix (e.g. “9”) and a “pause” before each fax or telephone number to gain access to the outside line.

(Australia & New Zealand only)

When you press **Redial/Pause**, a dash “-” will appear on the display. By storing a pause, you can create a delay of 3.5 seconds.

## Tone/Pulse (Not available in New Zealand)

---

If you have pulse dialling service, but need to send tone signals (for telephone banking, for example), follow the directions below. If you have touch tone service, you do not need this feature to send tone signals.

- 1 Lift the handset and dial the number.
- 2 When you are asked to enter any number, press **#** on the control panel of the machine. Any digits dialled after this sends tone signals.
- 3 When you hang up, the machine returns to pulse dialling service.



# Answering a Call

## F/T (FAX/TEL) Mode

---

When you share one line for your telephone and fax machine, in the F/T (FAX/TEL) mode, the fax machine can determine whether an incoming call is a fax or a telephone call. (See *Answer Mode Settings*, page 23.)

## Answering Calls with the Speakerphone (Only for FAX-737MC)

---

When the machine rings, instead of lifting the handset, press **Speaker Phone**. Speak clearly, toward the microphone. To end the call, press **Speaker Phone**.

If you have a bad telephone line connection, the other party might hear your voice echoed during the call. Hang up and try the call again—**OR**—Pick up the handset.

## Mute

---

- 1 Press **Search/Mute** to put a call on hold.
- 2 You can replace the handset without disconnecting the call.
- 3 Pick up the machine's handset or press **Speaker Phone** (for FAX-737MC only) to release the call from hold.

If you press **Search/Mute** without lifting the handset or pressing **Speaker Phone** (for FAX-737MC only), this key works as the Search key.



You can select a music type or set to off the music during a call put on hold. (See *Setting the Music on Hold*, page 16.)

## Hook Key (Only for FAX-717/727)

---

If you pick up the machine's handset and press **Hook** when you are talking lifting the external telephone's handset, now you can talk to the other party at the machine.

## Transmission Report and Journal Setting

Two reports require initial setup in the Menu table: Transmission Verification Report and Journal Period. For initial setup:

Press **Menu/Set, 7, 1.**

1. XMIT REPORT

—OR—

Press **Menu/Set, 7, 2.**



2. JOURNAL PERIOD

### Customizing the Transmission Verification Report

You can use the Transmission Report as proof that you sent a fax. This report lists the name or fax number of the receiving party, the time and date of transmission, and if the transmission was successful.





When the feature is **OFF**, the report is printed automatically only if there's an error during transmission. If the report indicates **ERROR**, send the document again. If the report indicates you should check the readability of certain pages, resend those pages.

When the feature is **ON**, the report is printed with every fax you send.

- 1 Press **Menu/Set, 7, 1.**
- 2 Press  or  to select **ON** or **OFF**, and press **Menu/Set.**
- 3 Press **Stop/Exit.**

### Setting the Journal Period

You can set the machine to print activity reports at specific intervals (every 30 faxes, 6, 12, 24 hours, 2 or 7 days). If you set the interval to **OFF**, you can print the report manually. (See *To Print a Report*, page 34.)

- 1 Press **Menu/Set, 7, 2.**
- 2 Press  and  key to choose your setting and press **Menu/Set.**
- 3 If you choose 7 days, the screen prompts you to choose a day at which to begin the 7-day countdown. Press  or  to choose your setting and press **Menu/Set.**
- 4 Enter the time to begin printing, in 24-hour format (for example, enter 19:45 for 7:45 PM), and press **Menu/Set.**
- 5 Press **Stop/Exit.**

# Using the Reports Key

You can print the following lists and reports:

- |                 |  |
|-----------------|--|
| 1.HELP LIST     | Lists basic operational steps and functions.   |
| 2.QUICK-DIAL    | Lists names and numbers stored in One Touch and Speed Dial memory, in numerical order.   |
| 3.FAX JOURNAL   | Journal lists information about the last 30 incoming and outgoing faxes. TX means Transmit; RX means Receive.  |
| 4.XMIT VERIFY   | Choose if Transmission Verification Report is printed after all Faxes sent.  |
| 5.TEL.INDEX     | Quick-dial list (above), alphabetically.   |
| 6.USER SETTINGS | Lists settings for <b>INITIAL SETUP</b> , <b>SETUP RECEIVE</b> , <b>SETUP SEND</b> , <b>REPORT SETTING</b> , <b>REMOTE FAX OPT (FAX-717/727)</b> , <b>SETUP MSG CTR (FAX-737MC)</b> , <b>SETUP MELODY (FAX-737MC)</b> and <b>MISCELLANEOUS</b> . |
| 7.MEMORY STATUS | Lists summary information and amount of occupied memory.   |

## To Print a Report

---

- 1 Make sure that there is no document in the Automatic Document Feeder.
- 2 Press **Copy/Reports**, then enter the number (see list above) of the report you want to print. For example, press **6** to print the **USER SETTINGS**.
- 3 Press **Stop/Exit**.

## Advanced Operations

### Electronic Cover Page (Only for FAX-727/737MC)

The cover page is sent to the receiving party's machine. Your cover page includes the name stored in the One Touch or Speed Dial memory, if you have used this feature to start the call.

The cover page indicates the fax is from your Station ID, and the number of pages you are sending. If you have **COVERPG SETUP** set to **ON** (see *Always Send Cover Page*, page 36), the number of pages on the cover page remains blank.

You can select a comment to include on your cover page, or you can select **1.COMMENT OFF** if you do not wish to include a comment.

As well as using one of the comments shown on the right, you can also enter up to two customized messages, each 27 characters long. (See *Composing Your Own Comments*, page 37.)

1. COMMENT OFF

2. PLEASE CALL

3. URGENT

4. CONFIDENTIAL

### Cover Page for Next Fax Only

Make sure Station ID is set up. (See *Setting the Station ID*, page 13.) This feature does not work without the Station ID.

You can set the fax to send a cover page with a particular document. This cover page will include the number of pages in your document.

**1** Insert the document face down in the Automatic Document Feeder.

**2** Press **Menu/Set, 3, 1**.

**3** Press **Menu/Set** when the screen displays **NEXT FAX ONLY**.

**4** Press  or  to select **ON** (or **OFF**), and press **Menu/Set**.

**5** Press  or  to view the comment selections.

**6** Press **Menu/Set** when the screen displays your selection.

**7** Enter two digits to indicate the number of pages you are sending. (Enter 00 to leave the number of pages blank.) If you have made a mistake, press  to back up and re-enter the number of pages.

1. COMMENT OFF

2. PLEASE CALL

3. URGENT

4. CONFIDENTIAL

5. (user defined)

6. (user defined)

**8** Press **Menu/Set**. The screen displays:

**9** Press **1** if you want to select additional settings. The display returns to the **SETUP SEND** menu—**OR**— Press **2** if you are finished choosing settings, and go to Step 10.

ACCEPTED

NEXT





1. YES 2. NO

**10** Enter the fax number you are calling and then press **Fax Start**.

## Always Send Cover Page

Make sure Station ID is set up. (See *Setting the Station ID*, page 13.) This feature does not work without the Station ID.

You can set the machine to send a cover page whenever you send a fax. The number of pages in your fax is not included when you use this setting.

- 1 Press **Menu/Set, 3, 1**.
- 2 Press  or  to select **ON** (or **OFF**).
- 3 Press **Menu/Set** when the screen displays **COVERPAGE:ON**. (If you select **ON**, a coverpage is always sent when you send a fax.)
- 4 If you selected **ON**, the screen displays the cover page comment options. Press  or  to view comment selections.
  - 1 . COMMENT OFF
  - 2 . PLEASE CALL
  - 3 . URGENT
  - 4 . CONFIDENTIAL
  - 5 . (user defined)
  - 6 . (user defined)
- 5 Press **Menu/Set** when the screen displays your selection. The screen displays:
  - ACCEPTED
  - NEXT
  - 1 . YES 2 . NO
- 6 Press **1** if you want to select additional settings. The display returns to the **SETUP SEND** menu—**OR**— Press **2** to exit if you are finished choosing settings.



## Using a Printed Cover Page

If you prefer using a printed cover page that you can write on, you can print the sample page and attach it to your fax.

- 1 Press **Menu/Set, 3, 1**.
- 2 Press  or  to select **PRINT SAMPLE**, and press **Menu/Set**.

=== COVER PAGE ===	
TO:	_____
FROM:	_____
FAX:	_____
TEL:	_____
	PAGE[S] TO FOLLOW
COMMENT:	

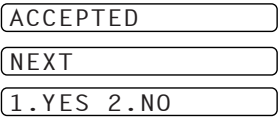

## Composing Your Own Comments

- 1 Press **Menu/Set, 3, 2**. The screen displays: **COVERPAGE NOTE**.
- 2 Use  or  to choose position 5 or 6 for your customized comment, and press **Menu/Set**.
- 3 Use the dial pad to enter your customized comment. (See *Entering Text*, page 106.)
- 4 Press **Menu/Set**. The screen displays:
- 5 Press **1** if you want to select additional settings. The display returns to the **SETUP SEND** menu—**OR**—Press **2** if you are finished choosing settings and exit.

## Overseas Mode





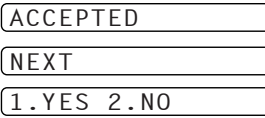

Sometimes, when sending a fax to overseas numbers, problems can be experienced. This mode makes the machine work better for such calls.

After you send a fax using this feature, the feature turns itself off.

- 1 Insert the document face down in the Automatic Document Feeder.
- 2 Press **Menu/Set, 3, 5**.
- 3 Press  or  to select **ON** (or **OFF**), and press **Menu/Set** when the screen displays your selection. The screen displays:
- 4 Press **1** if you want to select additional settings. The display returns to the **SETUP SEND** menu—**OR**—Press **2** if you have finished choosing settings, then go to Step 5.
- 5 Enter the fax number you are calling, and press **Fax Start**.

## Memory Transmission

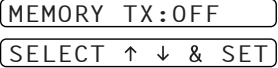
This feature allows your machine to scan a fax into its memory and send it as soon as the scan is complete. This way, you don't have to wait for the entire fax to be transmitted before you retrieve your document.

- 1 Insert the document face down in the Automatic Document Feeder.
- 2 Press **Menu/Set, 3, 9**.
- 3 To change the default setting, press  or  to select **ON** (or **OFF**) and press **Menu/Set**. Go to Step 5—**OR**—For the next fax transmission only, press  or  to select **NEXT FAX ONLY** and press **Menu/Set**.
- 4 For the next fax only, press  or  to select **ON** (or **OFF**) and press **Menu/Set**.
- 5 Press **1** to select additional settings. The display returns to the **SETUP SEND** menu—**OR**—Press **2** if you are finished choosing settings and go to Step 6.
- 6 Enter fax number and press **Fax Start**.



If you get a **OUT OF MEMORY** message while scanning the first page of a fax, press **Stop/Exit** to cancel the scan. If you get a **OUT OF MEMORY** message while scanning in a subsequent page, you'll have the option to press **Fax Start** to transmit the pages scanned so far, or to press **Stop/Exit** to cancel the operation. In this case, send the fax by the Manual Transmission.







Depending on your typical faxes, **OUT OF MEMORY** errors can occur frequently. If this happens, change the Memory Transmission setting back to **OFF**.

## Call Reservation (Only for FAX-727/737MC)

You can send a fax and let the other party know that you want to speak to him after the fax transmission is completed. The other fax machine will ring as if it were receiving a telephone call; if the other party picks up the handset, your machine will ring. Lift the handset to have a conversation.

If you set Call Reservation and Call Back message to **ON**, your machine leaves a message if the other party does not answer.

- 1 Insert the document face down in the Automatic Document Feeder.
- 2 Press **Menu/Set**, **3**, **6**. The screen displays the current setting for Call Reservation.
- 3 Press  or  to select **ON** (or **OFF**), and press **Menu/Set** when the screen displays your selection.
- 4 If you set Call Reservation to **ON**, the screen displays the current setting for Call Back Message. Press  or  to select **ON** (or **OFF**), and press **Menu/Set** when the screen displays your selection. The screen displays
 

ACCEPTED

NEXT

1 . YES 2 . NO
- 5 Press **1** if you want to select additional settings. The display returns to the **SETUP SEND** menu—**OR**— Press **2** if you are finished choosing settings, and go to Step 6. The screen prompts you to enter the fax number you want to call.
- 6 Enter the fax number, and press **Fax Start**.
- 7 If you've set Call Reservation to **ON**, pick up your handset if the machine rings.



You cannot use auto redial with Call Reservation. You cannot use Call Reservation with Delayed Transmission or with Polling. You must register your Station ID to set Call Back Message to **ON**.

## Print Sample Call Back Message

- 1 Press **Menu/Set**, **3**, **6**.
- 2 Press  or  to select **PRINT SAMPLE**, and press **Menu/Set**.

## Delayed Transmission (Timer)

You can use this function to send a fax up to 24 hours later.

- 1 Insert the document face down in the Automatic Document Feeder.
- 2 Press **Menu/Set**, **3**, **7**.
- 3 Enter the time you want the fax to be sent, in 24-hour format (for example, enter 1945 for 7:45 PM), and press **Menu/Set**.
- 4 Press **1** if you want to select additional settings. The display returns to the **SETUP SEND** menu—**OR**—Press **2** if you are finished choosing settings and go to Step 5. The screen prompts you to enter the fax number.
- 5 Enter the fax number, and press **Fax Start**. The machine will wait until the time you have entered to send the fax.

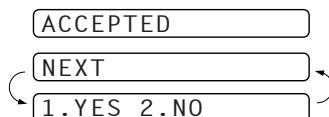

## Next-Fax Reservation (Only for FAX-727/737MC)

Even if your machine is receiving another fax, you can prepare to send your next fax. This way, you don't have to wait for it to finish sending or receiving the other fax. You can dial this fax call manually, or by using Redial or One Touch dialling. (When you use One Touch Dial, only the memory location—not the name of the person you are calling—is displayed.)

- 1 Insert the document face down in the Automatic Document Feeder. If necessary, press **Resolution** to adjust resolution.
- 2 Enter the fax number, and press **Fax Start**.
- 3 Press **Menu/Set**. The screen displays **NEXT-FAX RESERVD**.
- 4 To cancel the reservation, remove the documents and press **Stop/Exit**.





- If you use Next-Fax Reservation, the machine will send a document without storing it in memory.
- You can't use this feature if there is a document waiting in the feeder (possibly for Delayed Transmission or Polling Transmit), or when the timer has been interrupted.



## Cancelling a Scheduled Job

---

You can cancel tasks you've scheduled such as Timer or Polling Transmit.

- 1 Press **Menu/Set**, **4**. Any waiting jobs appear on the display. If no job is waiting, the screen displays **NO JOB WAITING**.
- 2 If you have more than two jobs waiting, use  or  to select the job you want to cancel. Press **Menu/Set** when the screen displays your selection—**OR**—If you have only one job waiting, go to Step 3.
- 3 Press **1** to cancel—**OR**—Press **2** to quit without cancelling.
- 4 Press **Stop/Exit**.

## Interrupting Timer and Polled Transmit Jobs

---

You can send a fax or make a copy now, even if you have the machine set to send a fax later, or if you have it set to be polled. However, you cannot use automatic redial or the Menu mode.

- 1 Press **Menu/Set**, **5**.
- 2 Wait 2 seconds, then remove the documents that are waiting in the Automatic Document Feeder.
- 3 Insert the document you want to send now in the Automatic Document Feeder.
- 4 Enter the number for the fax you want to send now, and press **Fax Start**.
- 5 After the transmission is finished, return the first document to the Automatic Document Feeder.
- 6 Press **Menu/Set**, **5** to restore the timer.



If you set Timer or Polled Transmit using the memory (that is, if you have already scanned the document into the machine's memory and will send it from there), you don't have to interrupt to send a fax or make a copy.

## Memory Security

---

This feature allows you to prevent unauthorised access to the machine. When switched ON, Memory Security prohibits most functions. The following functions listed are available while Memory Security is switched ON.

- Receiving faxes into memory [limited by Memory Capacity].
- Scheduled Delayed Transmission\*
- Polling\*
- Fax Forwarding\*
- Remote Retrieval

\* Provided it was set before Memory Security was switched ON.





The stored documents will be saved for up to 15 hours in the event of a power failure (FAX-737MC). The stored documents will not be saved in the event of a power failure (FAX-717/727).

## Using Memory Security

You must use a password to switch Memory Security ON and OFF.

### Setting Up Memory Security for the First Time

- 1 Press **Menu/Set, 0, 1**.
- 2 Enter a 4-digit number as a password.
- 3 Press **Menu/Set**.  
The screen prompts you to re-enter the password.
- 4 Re-enter the password and press **Menu/Set**.
- 5 Press  or  to choose **SET SECURITY**.
- 6 Press **Menu/Set**.  
The screen prompts you to enter the password.
- 7 Enter a 4-digit password, followed by **Menu/Set**.  
This is the same as the security password of the machine already stored.

NEW PASSWD:-----  
ENTER & SET

VERIFY:-----  
ENTER & SET



PASSWORD:-----  
ENTER & SET

The screen displays **ACCEPTED** for 2 seconds, followed by **SECURE MODE - Memory Security** is now switched ON.



If the password you enter at Step 7 is incorrect, the screen would display **WRONG PASSWORD**. After 2 seconds the display will then return to Miscellaneous Menu. You must then switch ON Memory Security again. (See *Switching Memory Security ON*, page 42.)

### Changing the Memory Security Password



- 1 Press **Menu/Set, 0, 1**.
- 2 Press  or  to choose **SET PASSWORD**.
- 3 Press **Menu/Set**.  
The screen prompts you to enter the old password.
- 4 Enter the current password.
- 5 Press **Menu/Set**.
- 6 Enter a 4-digit number as a new password.
- 7 Press **Menu/Set**.  
The screen prompts you to re-enter the new password.
- 8 Enter the new password again and press **Menu/Set**.
- 9 Press **Stop/Exit**.

OLD PASSWD:-----  
ENTER & SET

NEW PASSWD:-----  
ENTER & SET

VERIFY:-----  
ENTER & SET

## Switching Memory Security ON

- 1 Press **Menu/Set, 0, 1**.
- 2 Press  or  to choose **SET SECURITY**.
- 3 Press **Menu/Set**.  
The screen prompts you to enter the password.
- 4 Enter a 4-digit password, followed by **Menu/Set**.  
This is the same as the security password of the machine already stored.

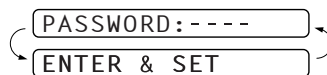

The screen displays **ACCEPTED** for 2 seconds, followed by **SECURE MODE - Memory Security** is now switched ON.



If the password you enter at Step 4 is incorrect, the screen would display **WRONG PASSWORD**. After 2 seconds the display will then return to Miscellaneous Menu. You must press **1** and then start from Step 2 to set Memory Security.

## Switching OFF Memory Security

- 1 When Memory Security is switched ON, press **Menu/Set**.
- 2 Enter a 4-digit password and press **Menu/Set**.

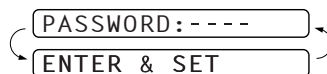

The screen displays **ACCEPTED**, then after 2 seconds the display reverts to normal. Memory Security is now switched OFF. Then all the data saved in the memory will be printed out.





If the password you enter at Step 2 is incorrect, the screen would display **WRONG PASSWORD**. After 2 seconds the display will then return to displaying **SECURE MODE**. You must then start from Step 1 to switch OFF Memory Security.

If you forget the Memory Security password, please contact your Brother dealer for service or the help number given with the warranty documentation.

## Multiple Resolution Transmission

Use this feature to select separate resolution settings for each page of the fax you are sending. This could be useful if you are sending a fax with photos and letters, or some pages with small print and others with normal print. Resolution settings return to **STANDARD** after the fax is sent.

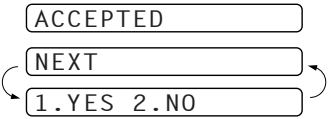
- 1 Insert the document face down in the Automatic Document Feeder, then press **Menu/Set, 3, 4.**
- 2 Use  or  to select resolution for page 1, and press **Menu/Set.**
- 3 Repeat Step 2 for subsequent pages. Press **Stop/Exit** when you are finished. The screen displays:  

- 4 Press **1** if you want to select additional settings. The display returns to the **SETUP SEND** menu—**OR**— Press **2** if you are finished choosing settings, and go to Step 5. The screen prompts you to enter the fax number you want to call.
- 5 Enter the fax number you are calling, and press **Fax Start.**



If you want to copy a document using multiple resolutions, press **Copy/Reports** in Step 5.

## Operation from an External or Extension Telephone

An external phone is a telephone that is plugged into the machine (either into the machine's EXT socket or into the back of the connector that plugs into the telephone wall socket).

An extension phone is another phone on the same phone number as the machine, but plugged into a different telephone wall socket. For example, the machine may be connected to a phone line in your study, and you may have another phone on the same line (and same phone number) in your kitchen. This feature enables you to answer the phone in the kitchen if it rings while you are making a coffee, knowing that you can transfer the call to the machine if the incoming call is a fax.

If you answer a fax call on an external or extension phone, you can make your machine take over by using the Fax Receive Code. When you press the Fax Receive Code \* 5 1 (\* 9 1 for New Zealand), the machine starts to receive a fax.

If the machine answers a voice call and F/T pseudo-rings for you to take over, use the Telephone Answer Code # 5 1 (# 9 1 for New Zealand) to take the call at an extension phone. The Telephone Answer Code is used only in F/T mode. (You have to set Remote Code to ON in **Menu/Set, 2, 4** to use \* 5 1 or # 5 1 (\* 9 1 or # 9 1 for New Zealand).)

If you answer a call, and no one is on the line, assume you are receiving a fax.

- If you are using the machine phone, press **Fax Start**, then hang up.
- If you are using an extension phone, press \* 5 1 (\* 9 1 for New Zealand), wait for fax receiving tones (chirps), then hang up.
- If you are using an external phone, press \* 5 1 (\* 9 1 for New Zealand) and wait for the phone to be disconnected (the screen displays **RECEIVE**) before you hang up. (Your caller will have to press **Fax Start** to send the fax.)



If you accidentally pick up an extension phone when a fax message is being received, you may disrupt the transmission or render some portions unreadable.

Extension telephones are not permitted in some countries, in such a case the Telephone Answer Code will not work.

The Remote Code also can be used by your callers. When you are using an external TAD, your outgoing message (OGM) should end with the statement "to send a fax, press \* 5 1 (\* 9 1 for New Zealand)". (See *Outgoing Message (OGM) of External TAD*, page 6.)

### For F/T (Fax/Tel) Mode Only

When the machine is in F/T mode, it will use the F/T Ring Time (F/T pseudo-ringing) to alert you to a voice call.

- If you are at the machine, you can lift the handset to answer.
- If you are at an extension phone, you will need to lift the handset during the F/T Ring Time and press # 5 1 (# 9 1 for New Zealand) between the F/T pseudo-rings.
- If no one is on the line, or if someone wants to send you a fax, send the call back to the machine by pressing \* 5 1 (\* 9 1 for New Zealand).

## Remote Call Transfer

In order to use the Activation Voice Code, you should first set **REMOTE CODE (Menu/Set, 2, 4)** to ON. (See *Changing Remote Codes*, page 46.)

This function works when you receive the incoming Voice call at the remote cordless phone externally connected to the fax machine. (See *Connecting an External Telephone*, page 7.) You can transfer voice call to the fax machine. But you can not transfer the incoming voice call from the fax machine to the cordless phone.

### To transfer telephone call to the fax machine

When you pick up the voice call at remote cordless phone and would like to transfer it to the fax machine,

- 1 Press Activation Voice Code \* **8 1** at remote cordless phone.
- 2 The fax machine rings (pseudo-ring same as current F/T ring) and the display shows **PICK UP PHONE**.
- 3 Pick up the handset and press **Hook** or **Speaker Phone** (for FAX-737MC only)—**OR**—Just press **Speaker Phone** (for FAX-737MC only) at the fax machine in order to transfer the voice call to the fax machine.



Don't hang up the call from the cordless phone until the voice call has been transferred to the fax machine. You will know when this is because you will no longer be able to hear or talk to the caller via the cordless phone. If you do not wait until this point before hanging up from the cordless phone, the call will be lost.

If nobody answers at the fax machine, pseudo-ringing stops after 30 seconds. In that case, it may still be possible to speak with the caller from the cordless phone. Speech between the fax machine and the cordless phone (= intercom) is not possible.

## Changing Remote Codes



---

Remote Codes might not work with some telephone systems. The preset Fax Receive Code is \* 5 1 (\* 9 1 for New Zealand). The preset Telephone Answer Code is # 5 1 (# 9 1 for New Zealand). The preset Activation Voice Code is \* 8 1.



If you are always disconnected when accessing your external TAD remotely, try changing the Fax Receive Code from \* 5 1 (\* 9 1 for New Zealand) to # # # and the Telephone Answer Code from # 5 1 (# 9 1 for New Zealand) to 1 1 1. You cannot use the same number for the Fax Receive Code, the Telephone Answer Code, and the Activation Voice Code.

### To change Remote Codes

- 1 Press **Menu/Set**, **2**, **4**.
- 2 Press  or  to select **ON** (or **OFF**), and press **Menu/Set** when the screen displays the setting you want.
- 3 If you want to, enter a new Fax Receive Code, then press **Menu/Set**.
- 4 If you want to, enter a new Telephone Answer Code, then press **Menu/Set**.
- 5 If you want to, enter a new Activation Voice Code, then press **Menu/Set**.
- 6 Press **Stop/Exit**.

## Telephone Service for Australia (Telstra<sup>®</sup> Duet)

### Distinctive Ringing (Telstra<sup>®</sup> FaxStream<sup>®</sup> Duet)

This machine feature lets you use the Distinctive Ringing subscriber service offered by Telstra's FaxStream<sup>®</sup> Duet, which allows you to have two separate telephone numbers on the one phone line. Each phone number has its own Distinctive Ringing pattern, so you know which phone number is ringing. This is one way you can have a separate phone number for your fax machine.

Your fax machine has a Distinctive Ringing function, allowing you to dedicate one phone number just for receiving faxes.



You can switch it off temporarily, then turn it back on. When you get a new fax number, make sure you reset this function.



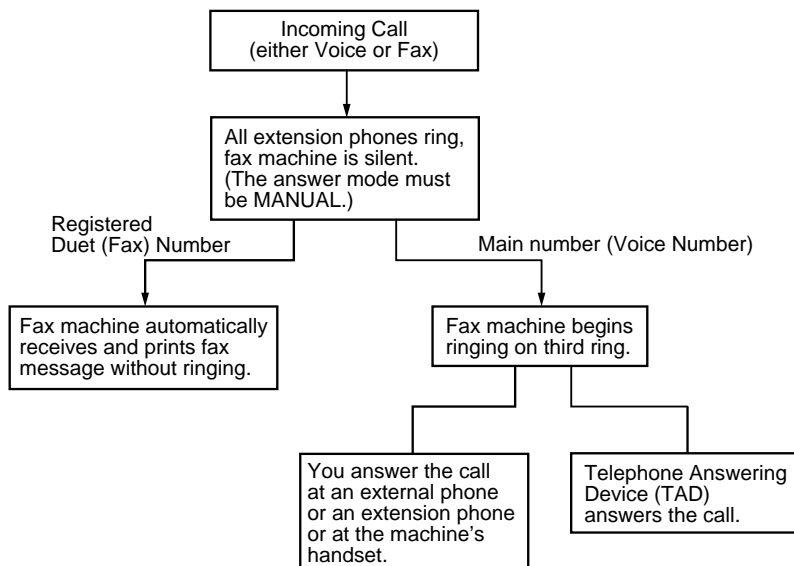

- In order for Duet to work properly, you must set your receive mode to **Manual** and set the Distinctive Ringing to **ON**.
- To have your external TAD answer only the main number, the machine must be in **Manual Mode**.

#### Flowchart Sequence of Incoming Call





## Set the Distinctive Ringing to ON

- 1 Disconnect the fax machine from any TAD or telephone company voice mail.
- 2 Press **Menu/Set, 0, 3**. The screen displays the current setting of this feature.
- 3 Press  or  to select **ON** (or **OFF**).
- 4 Press **Menu/Set**.
- 5 Press **Stop/Exit**.



If you set the Distinctive Ringing to ON, the receive mode will turn to Manual mode automatically.  
Only in the MC mode, even if you set the Distinctive Ringing to ON, the receive mode will not be changed.

## Caller ID (Caller IDentification)

---

Caller ID is a telephone service that allows the subscriber to see a display of the caller's phone number or name as the telephone rings. It is a fast way to screen your calls. You can respond quickly to calls you missed, because Caller IDs are received and stored in your fax machine memory.



To get the Caller ID Service: apply for the Caller ID service at your local telephone company, if available.

### Advantages of Caller ID

#### For Business

All businesses profit from a quicker response to customer calls. Businesses that provide mail order services, memory-lending services or provide confidential information, can protect themselves from false orders or acceptance of false identification.

#### At Home

Residential customers can protect themselves from unwanted calls.

## How Does the Caller ID Work?

---

### The Caller ID Appears on the Display When Your Telephone Rings

As your telephone rings, the display shows you the caller's phone number or name. Once you pick up the handset, the caller's ID disappears. You will see up to the first 16 characters of the number on the display.

### Helpful Hints

- If # **UNAVAILABLE** appears on the display, it means that the call came from outside your caller ID service area or a public phone. \*
- If # **WITHHELD** appears on the display, it means the caller intentionally blocked the transmission of his/her ID. \*
- If no caller ID was transmitted to your fax machine, **PICK UP PHONE** will remain on the display.

\* Depends on network Function.

## The Caller ID is Stored in Your Machine's Memory

The FAX can store a maximum of the last 30 incoming caller IDs in the memory, along with the time and date of reception, The 31st call will cause the oldest ID to be erased.







The Caller ID information stored in the memory can be used for the following.

### ■ Printing the Caller ID List.



You can review calls you received by checking the Caller IDs in memory. This report will list the Date, Time, Phone Number (Caller ID), and type of Call (Comment).

## Viewing Caller ID List

Caller ID memory stores information for up to thirty calls; when the thirty-first call comes in, information about the first call is erased. You can scroll through Caller ID information to review those calls made to your FAX.





- 1 Press **Menu/Set, 0, 2**.
- 2 Press  or  to select **DISPLAY ID** and press **Menu/Set**.  
If the name was not received, it will not be displayed.
- 3 Press  or  to scroll through the Caller ID memory to select the Caller ID you want to view and press **Menu/Set**.  
The next screen shows the caller's telephone number and the date and time of the call.
- 4 Press  or  to return to the Caller ID listing—**OR**—Press **Stop/Exit** to exit.

### Printing Caller ID List

- 1 Press **Menu/Set, 0, 2**.
- 2 Press  or  to select **PRINT REPORT**.
- 3 Press **Menu/Set**.

### Returning a Call from the Log

You can scroll through the Caller ID Log and select a call to return automatically.

- 1 Press **Menu/Set, 0, 2**.
- 2 Press  or  to select **DISPLAY ID** and press **Menu/Set**.  
If the name was not received, it will not be displayed.
- 3 Press  or  to scroll through the Caller ID Log and when you see a call you want to return immediately, press **Menu/Set**.
- 4 To begin dialling, press **Fax Start**.
- 5 Begin speaking when the other party answers.

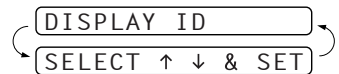

DISPLAY ID  
SELECT ↑ ↓ & SET

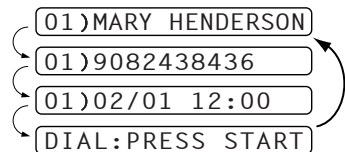

(01) MARY HENDERSON  
(01) 9082438436  
(01) 02/01 12:00  
DIAL:PRESS START



This feature may not be available in certain area.

# Telephone Service for New Zealand

## FaxAbility

---

FaxAbility is a service offered by Telecom that allows you to have an additional number on one phone line, with its own distinctive ring pattern. This way, when you get an incoming call, you can identify the number being called by its ring.

### How Will the Fax Machine Treat All Other Numbers?

FaxAbility mode ensures that the machine will answer calls to the FaxAbility (secondary) number. When a call comes in to your main number, all the phones will ring. You can set an external answering device (TAD) to answer calls on the other number(s). (See the chart in the following page.)

If you change the answer mode on the fax machine to FAX/TEL (F/T) or FAX ONLY mode, that setting will override the FaxAbility setup. **In FAX/TEL (F/T) or FAX ONLY mode, your fax machine will answer all the phone numbers (including its own ring pattern).**

### What is the Advantage of Using the FaxAbility Function?

Using FaxAbility is the most efficient way to receive both fax and telephone calls on the same line. It is much easier for your callers who dial manually. The fax machine will answer with receiving tones so they will not have to press an Fax Receive Code. And the people who call to talk on your main number will not have to talk to your fax machine. Basically, it gives you two independent numbers without the higher cost of a second line.

### How Does FaxAbility Work?

Your telephone number will have the standard ring pattern of long, long tone, while the new number will have a ring pattern of long, silence, long, etc. When FaxAbility is **ON**, you will not hear the first ring of all incoming calls on the fax machine. Extension phones will ring as usual. If the fax machine recognizes the ring pattern, all ringing will stop and the fax machine will answer and automatically receive the fax message. Otherwise, you will hear the extension phones and the fax machine continue to ring. The fax machine always listens to the ring pattern before it answers, so do not pick up the phone during that time. You will quickly learn to recognize the ring pattern for faxes, so you will not be tempted to answer that number. Either you or a telephone answering device can answer the main number(s).

## Flowchart Sequence of Incoming Call

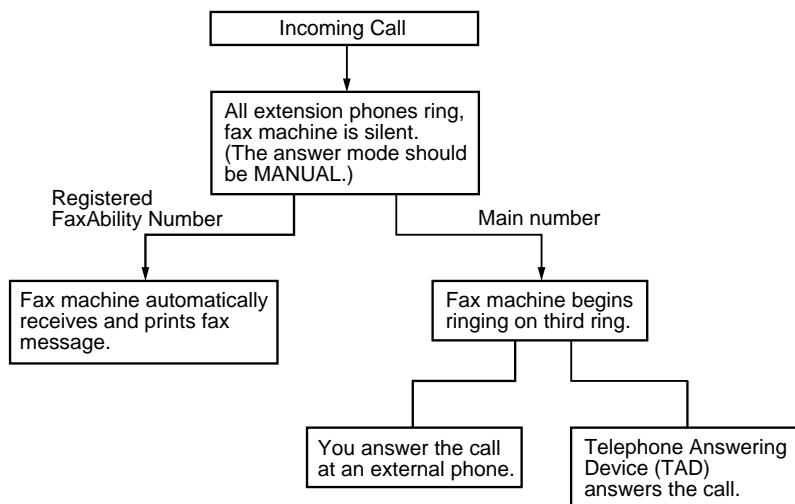

### How to Turn FaxAbility OFF or ON

The FaxAbility function is designed to accommodate the FaxAbility service provided by Telecom. To change the setting, repeat Steps 1-3; Step 2 is where you can select either **ON** or **OFF**.

Call Waiting beeps caused by incoming calls on your main number can affect fax transmissions.



If you have FaxAbility Service but don't have Call Waiting, you need do nothing at this stage.

If you do have Call Waiting as well as FaxAbility, set the Call Waiting menu option to **ON**. See below. The machine can suspend Call Waiting when incoming faxes are being sent to you.

**1** Set the fax machine to Manual Mode.

**2** Press **Menu/Set, 0, 3**.

3. FAXABILITY

**3** Press  or  to select **ON** (or **OFF**).

FAXABILITY:OFF

FAXABILITY:ON

**4** Press **Menu/Set**.

Only when FAXABILITY is set **ON**, Call Waiting can be selected **ON**.

CALL WAITING:OFF

In case of FAXABILITY is set **OFF**, Call Waiting is automatically **OFF** without choice.

CALL WAITING:ON

**5** Press **Menu/Set**.

**6** Press **Stop/Exit**.

## Caller ID (Caller IDentification)

---

Caller ID is a telephone service that allows the subscriber to see a display of the caller's phone number as the telephone rings. It is a fast way to screen your calls. You can respond quickly to calls you missed, because Caller IDs are received and stored in your machine's memory.



To get the Caller ID Service: apply for the Caller ID service at your local telephone company, if available.

### Advantages of Caller ID

#### For Business

All businesses profit from a quicker response to customer calls. Businesses that provide mail order services, memory-lending services or provide confidential information, can protect themselves from false orders or acceptance of false identification.

#### At Home

Residential customers can protect themselves from unwanted calls.

### How Does the Caller ID Work?

#### The Caller ID Appears on the Display When Your Telephone Rings

As your telephone rings, the display shows you the caller's phone number. Once you pick up the handset, the caller's ID disappears. You will see up to the first 16 characters of the number on the display.







### Helpful Hints

- If # **UNAVAILABLE** appears on the display, it means that the call came from outside your caller ID service area. \*
- If # **WITHHELD** appears on the display, it means the caller intentionally blocked the transmission of his/her ID. \*
- If no caller ID was transmitted to your fax machine, **PICK UP PHONE** will remain on the display.



\* Depends on network Function.

### Viewing Caller ID List

Caller ID memory stores information for up to thirty calls; when the thirty-first call comes in, information about the first call is erased. You can scroll through Caller ID information to review those calls made to your fax machine.

- 1 Press **Menu/Set, 0, 2**.
- 2 Press  or  to select **DISPLAY ID** and press **Menu/Set**.  
If the name was not received, it will not be displayed.
- 3 Press  or  to scroll through the Caller ID memory to select the Caller ID you want to view and press **Menu/Set**.  
The next screen shows the caller's telephone number and the date and time of the call.
- 4 Press  or  to return to the Caller ID listing—**OR**—Press **Stop/Exit**.

## Printing Caller ID List

- 1 Press **Menu/Set, 0, 2**.
- 2 Press  or  to select **PRINT REPORT**.
- 3 Press **Menu/Set**.







If you use the Caller ID for Dial back...

- Please be sure that you use appropriate dialling procedures for local and national call.
- Please be sure that you make sure of the details of the exact number to be called back, and the need to insert prefix(es) for manual dialling.
- Please understand that you machine may not display precisely the digits to be called.

## Returning a Call from the Log

You can scroll through the Caller ID Log and select a call to return automatically.

- 1 Press **Menu/Set, 0, 2**.
- 2 Press  or  to select **DISPLAY ID** and press **Menu/Set**.  
If the name was not received, it will not be displayed.
- 3 Press  or  to scroll through the Caller ID Log and when you see a call you want to return immediately, press **Menu/Set**.
- 4 To begin dialling, press **Fax Start**.
- 5 Begin speaking when the other party answers.

DISPLAY ID  
SELECT ↑ ↓ & SET

(01)MARY HENDERSON  
(01)9082438436  
(01)02/01 12:00  
DIAL:PRESS START



This feature may not be available in certain area.

# Telephone Service for Some Countries

## Distinctive Ringing (For Singapore and Hong Kong)

---

This fax machine feature lets you use the Distinctive Ringing subscriber service offered by some telephone companies, which allows you to have several telephone numbers on one phone line. Each phone number has its own Distinctive Ringing pattern, so you'll know which phone number is ringing. This is one way you can have a separate phone number for your fax machine.

Your fax machine has a Distinctive Ringing function, allowing you to dedicate one phone number just for receiving faxes. You'll need to set Distinctive Ringing to ON.



You can switch it off temporarily, then turn it back on. When you get a new fax number, make sure you reset this function.



- The fax machine will answer only calls to the Distinctive Ringing number.
- To have your external TAD answer only the main number, the fax machine must be in Manual Mode.
- In FAX/TEL (F/T) or FAX ONLY mode, the fax machine will answer all numbers on the phone line.



If you set the Distinctive Ringing to ON, the receive mode will turn to Manual mode automatically.

Only in the MC mode, even if you set the Distinctive Ringing to ON, the receive mode will not be changed.

## Setting the Distinctive Ringing

- 1 Press **Menu/Set, 0, 3**.
- 2 Press  or  to select **ON** (or **OFF**).
- 3 Press **Menu/Set**.
- 4 Press **Stop/Exit**.

## Caller ID (For Singapore, Hong Kong and Philippine)

---

The Caller ID feature of this machine lets you use the Caller ID subscriber service offered by many local phone companies. This service provides you, by means of the screen display, the telephone number (or name) of your caller as the line rings.

After a few rings, the screen displays the telephone number of your caller (or name, if available). Once you pick up the handset, the Caller ID information disappears from the screen, but the call information remains stored in the Caller ID memory.

- You will see the first 16 characters of the number or name.
- **# UNAVAILABLE** display means call originates outside your Caller ID service area.
- **# WITHHELD** display means the caller has intentionally blocked transmission of information.
- **PICK UP PHONE** display remains on the screen when no Caller ID information was transmitted.









If both the name and number are received, the screen displays only the name.

You can print a list of Caller ID information received by your machine.

Caller ID service varies with different carriers. Call your local phone company to determine the kind of service available in your area.

## Viewing Caller ID List

Caller ID memory stores information for up to thirty calls; when the thirty-first call comes in, information about the first call is erased. You can scroll through Caller ID information to review those calls made to your machine.





- 1 Press **Menu/Set, 0, 2**.
- 2 Press  or  to select **DISPLAY ID** and press **Menu/Set**.  
If the name was not received, it will not be displayed.
- 3 Press  or  to scroll through the Caller ID memory to select the Caller ID you want to view and press **Menu/Set**.  
The next screen shows the caller's telephone number and the date and time of the call.
- 4 Press  or  to return to the Caller ID listing—**OR**—Press **Stop/Exit**.

## Printing Caller ID List

- 1 Press **Menu/Set, 0, 2**.
- 2 Press  or  to select **PRINT REPORT** and press **Menu/Set**.

## Returning a Call from the Log

You can scroll through the Caller ID Log and select a call to return automatically.

- 1 Press **Menu/Set, 0, 2**.
- 2 Press  or  to select **DISPLAY ID** and press **Menu/Set**.  
If the name was not received, it will not be displayed.
- 3 Press  or  to scroll through the Caller ID Log and when you see a call you want to return immediately, press **Menu/Set**.
- 4 To begin dialling, press **Fax Start**.
- 5 Begin speaking when the other party answers.

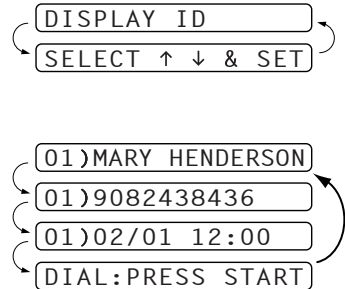

This feature may not be available in certain area.



# 10 Polling



Polling is the process of retrieving faxes from another machine. You can use your machine to “poll” other machines, or you can have someone poll your machine.



All parties involved in polling need to set up their machines to accommodate polling. When someone polls your machine to receive a fax, they pay for the call; if you poll someone’s fax machine to receive a fax, you pay for the call. (See *Polled Transmit*, page 58.)

## Polling Receive

### Setup for Polling Receive (Standard)

---

Polling Receive is when you call another fax machine to receive a fax from it.

- 1 Press **Menu/Set**, **2**, **7**. The screen displays
- 2 Press  or  to choose **STANDARD**, and press **Menu/Set**.





The screen prompts you to enter the fax number you want to poll, and then to press **Fax Start**.

- 3 Enter the fax number you are polling, and press **Fax Start**.  
The screen displays **DIALLING**.

### Setup for Polling Receive with Secure Code

---

You need to make sure you are using the same ID number as the other party.

- 1 Press **Menu/Set**, **2**, **7**.
- 2 Press  or  to choose **SECURE**, and press **Menu/Set**.

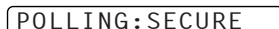

- 3 Enter a four-digit number.

This is the same as the security code of the fax machine you are polling.



- 4 Press **Menu/Set**.

The screen prompts you to enter the fax number you want to poll, and then to press **Fax Start**.

- 5 Enter the fax number, and press **Fax Start**.

## Setup Delayed Polling Receive

You can set your machine to begin Polling Receive at a later time.



- 1 Press **Menu/Set, 2, 7**.
- 2 Press  or  to choose **TIMER**, and press **Menu/Set**. POLLING : TIMER
- 3 The screen prompts you to enter the time you want to begin polling.
- 4 Enter the time (in 24-hour format) you want to begin polling.  
For example, enter 21:45 for 9:45 PM.
- 5 Press **Menu/Set**.  
The screen prompts you to enter the fax number you are polling and then to press **Fax Start**.
- 6 Enter the fax number, and press **Fax Start**. The machine makes the polling call at the time you entered.



You can set up only one Delayed Polling.



## Sequential Polling

Your machine can request documents from several fax units in a single operation. You just specify several destinations in Step 4. Afterward, a Sequential Polling Report will be printed.

- 1 Press **Menu/Set, 2, 7**. The screen displays POLLING : STANDARD
- 2 Press  or  to choose **STANDARD, SECURE** or **TIMER**, and press **Menu/Set** when the screen displays the setting you want.
- 3 If you selected **STANDARD**, the screen prompts you to enter the fax number you want to poll, and then to press **Fax Start**.
  - If you selected **SECURE**, enter a four-digit number and press **Menu/Set**.
  - If you selected **TIMER**, enter the time (in 24-hour format) you want to begin polling and press **Menu/Set**.
- 4 Specify the destination fax machines, which you wish to poll by using One Touch, Speed Dial, Search or a Group. For example, for One Touch **3** and Speed Dial location **09**, press One Touch Dial key **3, Search/Mute, #** and **09**. (See *Dialling a Number*, page 21.)
- 5 Press **Fax Start**.  
Your machine polls each number or group number in turn for a document.

## Cancelling a Scheduled Job

This function allows you to cancel tasks that you've scheduled such as Delayed Fax, Delayed Polling Receive or Polling Transmit.



- 1 Press **Menu/Set**, **4**. Any waiting jobs appear on the display. If nothing is waiting, the screen displays **NO JOB WAITING**.
- 2 If you have more than two jobs waiting, use  or  to select the job you want to cancel. Press **Menu/Set** when the screen displays your selection—**OR**—If you have only one job waiting, go to Step 3.
- 3 Press **1** to cancel—**OR**—Press **2** to exit without cancelling.
- 4 Press **Stop/Exit**.

## Polled Transmit

Polling Transmit is when you set up your fax machine to wait with a document so another fax machine can retrieve it.

- 1 Insert the document to be retrieved in the Automatic Document Feeder.

- 2 Press **Menu/Set**, **3**, **8**. The screen displays

- 3 Press  or  to choose **STANDARD**, and press **Menu/Set**.

POLLING : STANDARD  
SELECT ↑ ↓ & SET

- 4 Press **1** to select **DOC** if you want your machine to scan the printed document at the time it is polled—**OR**—Press **2** to select **MEMORY**.

1 . DOC 2 . MEMORY  
ACCEPTED

- 5 Press **1** if you want to select additional settings. The display returns to the **SETUP SEND** menu—**OR**—Press **2** if you are finished choosing settings and go to Step 6.

NEXT  
1 . YES 2 . NO

- 6 Press **Fax Start**. The screen displays **POLLED WAITING**.





If you do not store the polled document into memory in Step 4, the polled document remains on the Automatic Document Feeder until your machine is polled. However, you can “interrupt” it to send another fax. (See *Interrupting Timer and Polled Transmit Jobs*, page 40.)

The document on the Automatic Document Feeder can only be polled once unless they had been stored in memory.

## Setup for Polling Transmit with Secure Code

When you set **POLLING:SECURE** to ON, anyone who polls your machine must enter the polling ID number.

- 1 Insert the document face down in the Automatic Document Feeder.
- 2 Press **Menu/Set, 3, 8**.
- 3 Press  or  to choose **SECURE**, and press **Menu/Set**.
- 4 Enter a four-digit number, and press **Menu/Set**.
- 5 Press **1** to select **DOC** if you want your machine to scan the printed document at the time it is polled—**OR**—Press **2** to select **MEMORY**.
- 6 Press **1** if you want to select additional settings. The display returns to the **SETUP SEND** menu—**OR**—Press **2** if you are finished choosing settings and go to Step 7.
- 7 Press **Fax Start** and wait for the fax to be polled.

POLLING: SECURE

1 . DOC 2 . MEMORY

ACCEPTED

NEXT

1 . YES 2 . NO

## Secure Polling

Secure Polling is a way to keep your documents from “falling into the wrong hands” while the fax machine is set up for polling. You can use Secure Polling only with another Brother fax machine. Your four-digit ID number must be entered on the fax machine that polls for your documents.



Some machines do not respond to the polling function.



# 11 Remote Fax Options (Only for FAX-717/727)

This chapter is for Model FAX-717/727. If you have model FAX-737MC your remote fax options are handled by the Message Centre. (See *Message Centre (Only for FAX-737MC)*, page 65.)

## Setting Fax Storage

---

If you set Fax Storage to **ON**, you will be able to retrieve fax messages from another location, using Fax Forwarding or Remote Retrieval functions. The screen will indicate when you have a fax stored in memory.

- 1 Press **Menu/Set, 8, 2**. The screen prompts you to choose fax settings.
- 2 Press  or  to select **ON** (or **OFF**), and press **Menu/Set** when the screen displays your selection.
- 3 Press **Stop/Exit**.



If there are faxes in memory when you turn the Fax Storage **OFF**, the screen prompts you to erase any faxes in memory. (See *Printing a Fax from Memory (Only for FAX-717/727)*, page 27.)

If you press **1**, all fax data is erased and Fax Storage is turned off. If the fax data in memory has not been printed before, it will be printed first, and then erased. If you press **2**, data is not erased, and Fax Storage remains on.

## Fax Forwarding





You cannot use Fax Forwarding or Remote Retrieval when “Fax Storage” is set to **OFF**.

## Programming a Fax Forwarding Number

---

When Fax Forwarding is set to **ON**, your fax machine stores the received fax in memory, then dials the fax machine phone number you have programmed, and forwards the fax message.

- 1 Press **Menu/Set, 8, 1**.
- 2 Press  or  to select **ON** (or **OFF**), and press **Menu/Set**.  
The screen prompts you to enter the number of the fax machine where faxes will be forwarded.
- 3 Enter the forwarding number (up to 20 digits), and press **Menu/Set**.
- 4 Press **Stop/Exit**.

# Remote Retrieval

You can call your machine from any touch tone phone (or remote Group 3 fax machine) and use a Remote Access Code and other button presses in order to check the receiving status, retrieve fax messages or change settings.

To receive faxes or the Memory Status List at your location, you must call from a fax machine using touch tone. For convenience, you can retrieve faxes and the Status List from a touch tone phone by having them sent to a fax machine.

For example, if your hotel room does not have a fax machine, you can enter the number of the fax machine at the hotel's Front Desk.

## Setting the Remote Access Code

---

Enter your Remote Access Code when the fax machine picks up your call, so you can access features remotely. The default code is inactive code (--- \*).

- 1 Press **Menu/Set, 8, 3**.
- 2 Enter a three-digit code using number keys 0-9, \*, and #, and press **Menu/Set**.  
The \* cannot be changed. Do not use the same digits that appear in your Fax Receive Code, Telephone Answer Code or Activation Voice Code.
- 3 Press **Stop/Exit**.

## Using Your Remote Access Code

---

- 1 Dial your fax machine phone number from a touch tone phone.
- 2 When your fax machine answers and beeps, immediately enter your Remote Access Code (3 digits followed by \*).
- 3 The fax machine signals if there are any messages received:  
**1 long beep—Fax message(s)**  
**No long beep—no messages**
- 4 The fax machine then prompts you with two short beeps to enter a command. If you wait longer than 30 seconds to enter a command, the machine hangs up. If you enter an invalid command, the machine beeps three times.
- 5 Press **9 0** to reset the machine when you finish.
- 6 Hang up.



If your fax machine is set to MANUAL mode, you can access your machine remotely by phoning it and letting it ring for about 100 (50 in Australia) seconds. Your fax machine will answer the phone after 100 (50 in Australia) seconds of ringing, and you then have 30 seconds to enter your Remote Access Code.

## Remote Commands

Follow the commands below to access features remotely. When you call the fax machine and enter your Remote Access Code (3 digits followed by \*), the system will signal you with two short beeps to enter a remote control command.

Remote control commands	Detail Operation
<b>95 Change Fax Forwarding Setting</b>	
1 OFF	If you hear one long beep, the change is accepted. If you hear three short beeps, you cannot change it because the conditions (ex. registering fax forwarding) have not been completed. You can register your fax forwarding number by using 4.FAX FWD NO. Once you have registered the number, the machine will automatically turn to "FAX FWD:ON" mode. Then, receive a Memory Status List by entering 961. Check the List to make sure the Fax Forwarding number you registered is correct. Now the machine will start Fax Forwarding.
2 Fax forwarding	
4 FAX FWD No.	
6 FAX STORAGE ON	You can set FAX STORAGE ON or OFF. (Switching Fax Storage OFF is only possible if there are no faxes stored in the memory, or if all faxes have been erased using Remote Control <b>9 6 3</b> .)
7 FAX STORAGE OFF	
<b>96 Retrieve FAX</b>	
1 Memory Status List	You must use a remote fax machine in order to receive a List of stored fax message(s).
2 Retrieve all FAX	
3 Erase FAX in the memory	If you hear one long beep, you can erase fax message(s) from the memory.
<b>97 Check the receiving status</b>	You can check whether your fax machine has received any fax message(s). If yes, you will hear one long beep. If no, you will hear three short beeps.
1 DOC	
<b>98 Change Answer Mode</b>	If you hear one long beep, you can change the answer mode. If you hear three short beeps, you cannot change it. (Example: There is no TAD MSG when you want to change to TAD mode.)
1 TAD	
2 F/T	
3 FAX	
<b>90 Exit</b>	After a long beep, you can exit remote control.

## Retrieving the Memory Status List

---

You can retrieve the Memory Status List from a remote fax machine to see if you have any fax messages.

- 1 Dial your fax machine's number.
- 2 When you hear the beep, immediately enter your Remote Access Code (3 digits followed by \*).
- 3 When you hear two short beeps, use the dial pad to press **9 6 1**.
- 4 Using the dial pad, enter the number (up to 20 digits) of the remote fax machine where you want the Memory Status List forwarded, and then press **# #**.



You cannot use \* and # as dial numbers. However, if you want to store a pause, press #.

- 5 After you hear your fax machine beep, hang up and wait.  
Your fax machine calls the remote fax machine and sends the Memory Status List. The remote fax machine prints the List.

## Retrieving Fax Messages

---

- 1 Dial your fax machine's number.
- 2 When you hear the beep, immediately enter your Remote Access Code (3 digits followed by \*).
- 3 As soon as you hear two short beeps, use the dial pad to press **9 6 2**.
- 4 Using the dial pad, enter the number (up to 20 digits) of the remote fax machine where you want your fax messages forwarded to, and then press **# #**.



You cannot use \* and # as dial numbers. However, if you want to store a pause, press #.

- 5 After you hear your fax machine beep, hang up and wait.  
Your fax machine calls the remote fax machine and sends the stored documents. The remote fax machine prints your fax messages.



## Changing the Fax Forwarding Number

---

You can change the default setting of your fax forwarding number from a remote fax machine.

- 1** Dial your fax machine's number.
- 2** When you hear the beep, immediately enter your Remote Access Code (3 digits followed by \*).
- 3** When you hear two short beeps, use the dial pad to press **9 5 4**.
- 4** Enter the new number of the remote fax machine where you want your fax messages forwarded, and then press **##**.



You cannot use \* and # as dial numbers. However, if you want to store a pause, press #.

- 5** To retrieve the Memory Status List, when you hear two short beeps, use the dial pad to press **9 6 1**.
- 6** Use the dial pad to enter the number of the remote fax machine (up to 20 digits), and then press **##**.
- 7** After you hear your fax machine beep, hang up and wait.  
Your fax machine calls the remote fax machine. Your fax machine then sends the Memory Status List showing the new forwarding number to the remote fax machine.
- 8** Check the forwarding number.  
If the forwarding number is incorrect, return to Step 1 to reset it.

## Message Centre Mode

Message Centre Mode allows you to store incoming fax and voice messages in a flexible memory. The memory stores **15** minutes of voice messages, or up to **20** pages of fax messages. The actual number of pages stored in memory varies depending on the content and the resolution used. Memory is shared between fax and voice messages, which are stored on a “first-come, first-served” basis. Any voice or fax message can be retrieved remotely.

You must record an Outgoing Message in order to use the Message Centre Mode. (See *Recording the Message Centre’s Outgoing Message (MSG CTR OGM)*, page 66.)

### Flexible Memory Settings (Message Store)

Message Centre Mode offers you six flexible memory settings, so that you can decide which kinds of messages you want to receive.

- 1. DOC:ON, VOICE:ON** Both voice and fax messages are stored. You can use the Fax Forwarding or Paging features and retrieve voice and fax messages remotely.
- 2. DOC:ON, VOICE:EXT** You need an external answering machine connected to the fax machine for this setting. Fax messages are stored in the Message Centre memory, but voice messages are stored in your external answering machine. Retrieve voice messages from the external answering machine. You cannot use the Paging feature for voice message with this setting.
- 3. DOC:ON, VOICE:OFF** All memory is used to store fax messages—no voice messages will be stored.
- 4. DOC:OFF, VOICE:ON** All memory is used to store voice messages—no fax messages will be stored. Incoming faxes will be printed on paper. You can use the Paging feature, and retrieve voice messages remotely.
- 5. DOC:OFF, VOICE:EXT** You need an external answering machine connected to the fax machine for this setting. Incoming faxes are not stored in memory, but will be printed on paper. Voice messages are stored in the external answering machine.
- 6. DOC:OFF, VOICE:OFF** Incoming faxes are not stored in memory, but will be printed on paper. Voice calls are not stored in memory.

### Setting Up Message Centre





You must set up Message Centre in the following order:

- 1** Set the Message Store.
- 2** Record the Message Centre’s Outgoing Message (**MSG CTR OGM**).
- 3** Activate Message Centre (MC) Mode by pressing .

## Setting the Message Store

---



Select the setting from the descriptions of “Flexible Memory Settings”.

- 1 Press **Menu/Set, 8, 1**. The screen prompts you to choose a **DOC** (Document) setting.
- 2 Press  or  to select **ON** (or **OFF**), and press **Menu/Set**.  
The screen prompts you to choose a **VOICE** setting.
- 3 Press  or  to select your setting from the list (**ON**, **OFF** or **EXT**), and press **Menu/Set** when the screen displays your selection.
- 4 Press **Stop/Exit**.

## Recording the Message Centre’s Outgoing Message (MSG CTR OGM)



---

Recording the Message Centre’s Outgoing Message (MSG CTR OGM) is the second step you need to follow before you can turn on the Message Centre. Make sure your OGM (Outgoing Message) is less than 20 seconds long.





- 1 Press **Menu/Set, 8, 3**. The screen prompts you to choose an OGM.
- 2 Press  or  to reach **MSG CTR OGM**.







This is the only setting you can select if you want to turn the Message Centre on.

- 3 Press **Menu/Set**.
- 4 Press  or  to select **RECORD MSG** and press **Menu/Set**.
- 5 Pick up the handset to record a message.  
**For example:** Hello. We are unable to take your call at this time. Please leave a message after the signal. If you wish to send a fax, please press the start button on your machine.
- 6 Press **Stop/Exit** and replace the handset. The Message Centre plays your OGM.
- 7 Press **Stop/Exit**.

## Listening the Outgoing Message (OGM)

- 1 Press **Menu/Set, 8, 3**.
- 2 Press  or  to select **MSG CTR OGM** (or **FAX/TEL OGM** or **PAGING OGM**), and press **Menu/Set** when the screen displays your selection.
- 3 Press  or  to select **PLAY MSG** and press **Menu/Set**. Adjust volume by pressing  or .
- 4 Press **Stop/Exit**.

## Erasing the Outgoing Message (OGM)

- 1 Press **Menu/Set**, **8**, **3**.
- 2 Press  or  to select **MSG CTR OGM** (or **FAX/TEL OGM** or **PAGING OGM**), and press **Menu/Set** when the screen displays your selection.
- 3 Press  or  to select **ERASE MSG** and press **Menu/Set**.
- 4 Press **1** to erase the OGM—**OR**—Press **2** to exit without erasing.
- 5 Press **Stop/Exit**.

## Activating Message Centre Mode

Press and hold  until the button lights and the screen displays **MC:MSG CTR**.

When  light is out, the Message Centre is off. (See *Setting Up Message Centre*, page 65.)

## Message Indicator

The  light flashes when you have new messages and/or faxes waiting for your review.

The LCD screen displays the total number of voice (including recorded conversations) and/or fax messages stored in Message Centre memory.

VOICE:03 DOC:02

If you press the flashing  to turn off the Message Centre before getting your new messages, they won't be lost. The new messages will be played automatically and the LCD will ask you to acknowledge the new faxes:

PRINT DOC?  
1 . YES 2 . NO

Press **1** to print (and automatically delete) the faxes from memory—**OR**—Press **2** to save the faxes in memory until printing is convenient.

## What Happens When the Memory Is Full...



If the memory becomes full when you have set your machine to Message Centre mode, the machine will change to F/T mode automatically. In this mode, the machine can accept incoming faxes automatically. Then, if your machine should run out of paper, the answer mode will shift automatically to manual mode. In manual mode the call is not answered, so your caller will know to try again later.

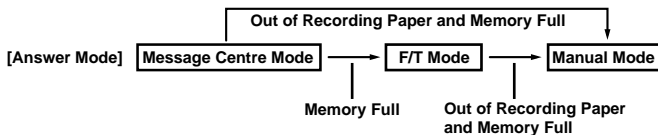



Print the Memory Status List and select the item to be cleared. This will clear space for new messages and faxes to be stored in memory. (See *Printing Reports*, page 33.)

## Playing Voice Messages

---

Follow the steps below to listen to voice messages.

- 1 Press **Play/Record**. Adjust volume by pressing  or .  
All new messages are played in the order they were recorded. The display shows the number of the current message, and the total number of messages.  
If Caller ID information was received, the machine beeps during the message and displays the Caller ID information for one second.  
During playback, the screen displays the time and date the message was recorded.
- 2 Press \* (RWD) at the end of the message to repeat a message. Use # (FWD) to skip to the next message. You can press \* and # repeatedly until you reach the message you want to play.
- 3 Press **Stop/Exit**.

## Printing a Fax Message

---

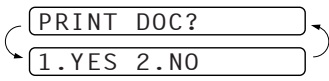

Once you print a new fax message stored in memory, it is erased from the memory automatically.

- 1 Press **Play/Record**. After two seconds, the machine begins to play voice messages.
- 2 After playing voice messages, the display asks if you want to print fax messages that are in the memory. There is no display if there are no faxes.
- 3 To print the fax messages, press **1**—OR—Press **2** to exit without printing.

## Backup Printing Option

---

When you choose **DOC:ON** in the Message Centre mode, all incoming fax messages are stored in the available memory for retrieval. To print a backup copy automatically, turn this option on.

- 1 Press **Menu/Set**, **8**, **2**. The screen prompts you to select a setting.
- 2 Press  or  to display **ON** (or **OFF**), and press **Menu/Set** when the screen displays your selected setting.
- 3 Press **Stop/Exit**.

## Erasing Messages



If you choose to erase all fax messages, the machine will print any previously unprinted fax messages before erasing them from memory. Fax messages cannot be erased individually.

You can erase voice messages individually, or all at once.

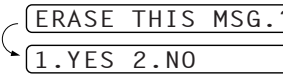
### To erase voice messages individually

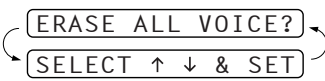

- 1 Press **Play/Record**. The machine beeps and begins message playback. Each message is preceded by one long beep, and followed by two short beeps.
- 2 To erase a specific message, press **Erase** immediately after the two short beeps, or while the message is playing. The screen prompts:
- 3 Press **1** to erase the message—**OR**—Press **2** to exit without erasing.
- 4 Press **Stop/Exit**.

### To erase messages all at once

- 1 Press **Erase**. The screen prompts you to choose what kind of messages you want to erase.
- 2 Press  or  to select erasing all voice messages (ALL VOICE), all document messages (ALL DOC.), or all messages—both voice and fax—(ALL MSG), and press **Menu/Set**.
- 3 Press **1** to erase—**OR**—Press **2** to exit without erasing.

## Setting the Maximum Time for Incoming Messages

Your machine comes set to receive voice messages up to 30 seconds long. You can change this setting to any length from 20 seconds to 60 seconds in 5-second increments.

- 1 Press **Menu/Set, 8, 4**. The screen prompts you to select a maximum time.
- 2 Press  or  to select the maximum time setting for incoming messages, and press **Menu/Set** when the screen displays your setting.
- 3 Press **Stop/Exit**.





## Setting the Toll Saver

---

When you set the Toll Saver feature, the machine answers after 5 (4 in Australia and New Zealand) rings if you don't have messages, and after 3 (2 in Australia and New Zealand) rings if you do have messages. This way, when you call the machine, if it rings 4 (3 in Australia and New Zealand) times, you know you have no messages, and can hang up, avoiding any toll charge.





When Toll Saver is **ON**, it overrides your Ring Delay setting. Toll Saver must be off for the machine to operate using your Ring Delay setting. (See *Setting the Ring Delay*, page 24.)

- 1 Press **Menu/Set, 2, 1**.
- 2 Press  or  to select **TOLL SAVER**, and press **Menu/Set**.
- 3 Press  or  to select **ON** (or **OFF**), and press **Menu/Set**.
- 4 Press **Stop/Exit**.

## ICM Recording Monitor

---

This feature lets you turn **OFF** (or **ON**) the speaker volume for voice messages. When you turn the monitor **OFF**, you will not hear messages as they come in.

- 1 Press **Menu/Set, 8, 5**.
- 2 Press  or  to select **OFF** (or **ON**), and press **Menu/Set**.
- 3 Press **Stop/Exit**.

## Recording a Conversation

---

You can record a telephone conversation by pressing **Play/Record** during the conversation. Your recording can be as long as the Incoming Message Maximum Time. The other party will hear a beep every 15 seconds while recording. You cannot record a conversation using the Speakerphone.

## Fax Forwarding/Paging

When Paging is set to **ON**, your machine dials the pager number you have programmed and, when connected, plays the Paging OGM message you have recorded for 60 seconds. This activates your pager and let you know you have a fax or voice message in the Message Centre memory.



When Fax Forwarding is set to **ON**, your machine dials the fax machine phone number you've programmed, and forwards any faxes you've received.



You cannot use Paging and Fax Forwarding at the same time.

## Programming a Fax Forwarding Number

---





- 1 Press **Menu/Set, 8, 6**.
- 2 Press  or  until the screen displays **FAX FORWARD**, and press **Menu/Set**.  
The screen prompts you to enter the number of the fax machine where faxes will be forwarded.
- 3 Enter the forwarding number (up to 20 digits), and press **Menu/Set**.
- 4 Press **Stop/Exit**.

You can change a Fax Forwarding number remotely.

## Recording the Paging Outgoing Message (OGM)

---

Before paging can work, you should first record the Paging OGM.



- 1 Press **Menu/Set, 8, 3**. The screen prompts you to choose an OGM.
- 2 Press  or  to reach **PAGING OGM**, and press **Menu/Set**.
- 3 Press  or  to select **RECORD MSG**, and press **Menu/Set**.
- 4 Pick up the handset to record a message.
- 5 Press **Stop/Exit** and replace the handset. The Message Centre plays your OGM.
- 6 Press **Stop/Exit**.



You can delete or play the Paging message in the same way as the MSG CTR OGM. (See *Recording the Message Centre's Outgoing Message (MSG CTR OGM)*, page 66.)

## Programming the Paging Number

---

- 1 Press **Menu/Set, 8, 6**.
- 2 Press  or  until the screen displays **PAGING**, and press **Menu/Set**.  
The screen prompts you to enter your pager number.
- 3 Enter your paging number up to 20 digits and press **Menu/Set**.  
This is the telephone number which your machine must call.
- 4 Press **Stop/Exit**.



You cannot change a Paging number remotely.



# Remote Retrieval

This section is for FAX-737MC. (If you have FAX-717/727, please see chapter 10 for your remote fax options.)

You can call your machine from any touch tone phone (or remote Group 3 fax machine set for tone) and use a Remote Access Code and Remote Control Commands to retrieve voice (and fax) messages. You can also program and change some settings for your Message Centre.

## Using the Remote Access Code

---

- 1 Dial your machine phone number from a touch tone phone.
- 2 When your machine answers and beeps, immediately enter your Remote Access Code.
- 3 The machine signals the kinds of messages received:
  - 1 long beep—Fax message(s)
  - 2 long beeps—Voice message(s)
  - 3 long beeps—Fax and Voice message(s)
  - No beeps—no messages
- 4 The machine then prompts you with two short beeps to enter a command. If you wait longer than 30 seconds to enter a command, the machine hangs up. If you enter an invalid command, the machine beeps three times.
- 5 Press **90** to reset the machine when you finish.
- 6 Hang up.



If your fax machine is set to MANUAL mode, you can access the Message Centre remotely by phoning your machine and letting it ring for about 100 (50 in Australia) seconds. Your fax machine will answer the phone after 100 (50 in Australia) seconds of ringing, and you then have 30 seconds to enter your Remote Access Code.

## Setting the Remote Access Code

---

Enter your Remote Access Code when the machine picks up your call, so you can access features remotely. The default code is inactive code (--- \*).

- 1 Press **Menu/Set, 8, 7**.
- 2 Enter a three-digit code using number keys 0-9, \*, and #, and press **Menu/Set**.  
The \* cannot be changed. Do not use the same digits that appear in your Fax Receive Code, Telephone Answer Code or Activation Voice Code.
- 3 Press **Stop/Exit**.



When you call your machine and enter the Remote Access Code, you must press the fourth digit (3 digit number plus \*).

## Remote Control Commands

Follow the commands below to access features remotely. When you call the fax machine and enter your Remote Access Code (3 digits followed by \*), the system will signal you with two short beeps to enter a remote control command.

Remote control commands		Detail Operation
<b>91 Playing voice messages</b>		After one long beep, the machine plays In-Coming Message (ICM).
	1 Skip back	Press <b>1</b> while listening to an ICM to play it again. If you press <b>1</b> before a message, you will hear the previous message.
	2 Skip next	While playing ICM, you can skip to next message.
	9 STOP Playing	Stop playing the ICM.
<b>93 Erase all ICM</b>		If you hear one long beep, the erase is accepted. If you hear three short beeps, you cannot erase because all voice messages have not been played, or there is no voice message to erase. *This code erases all recorded messages, not one at a time.
<b>94 Play and Record OGM in memory</b>		
1 Play	1 MSG CTR OGM	The machine plays the selected OGM. You can stop playing OGMs by pressing <b>9</b> .
	2 FAX/TEL OGM	
	3 PAGING OGM	
2 Record	1 MSG CTR OGM	After one long beep, you can record the selected OGM. You will hear the message played once. You can stop recording the message by pressing <b>9</b> .
	2 FAX/TEL OGM	
	3 PAGING OGM	
<b>95 Changing Fax Forwarding/Paging setting</b>		If you hear one long beep, the change is accepted. If you hear three short beeps, you cannot change it because the conditions have not been met (Example: registering paging number). You can register your fax forwarding number by using 4.FAX FWD NO. (See <i>Changing the Fax Forwarding Number</i> , page 76.) Once you have registered the number, the machine will automatically turn to "FAX FWD:ON" mode. Then retrieve a Memory Status List by entering <b>961</b> to make sure that the Fax Forwarding number you registered is correct in the List.
	1 OFF	
	2 Fax Forwarding	
	3 Paging	
	4 FAX FWD NO.	

Remote control commands	Detail Operation			
<b>96 Retrieve Fax</b> <table border="1" data-bbox="213 172 423 316"> <tr> <td data-bbox="213 172 423 209">1 Memory Status List</td> </tr> <tr> <td data-bbox="213 209 423 245">2 Retrieve all FAX</td> </tr> <tr> <td data-bbox="213 245 423 316">3 Erase FAX in the memory</td> </tr> </table>	1 Memory Status List	2 Retrieve all FAX	3 Erase FAX in the memory	Enter the number of a remote fax machine to receive a report or stored fax messages. (See <i>Retrieving the Memory Status List</i> , page 75 and <i>Retrieving Fax Messages</i> , page 75.)  If you hear one long beep, you can erase the fax message from the memory.
1 Memory Status List				
2 Retrieve all FAX				
3 Erase FAX in the memory				
<b>97 Check the receiving status</b> <table border="1" data-bbox="213 352 423 432"> <tr> <td data-bbox="213 352 423 389">1 Document</td> </tr> <tr> <td data-bbox="213 389 423 432">2 Voice</td> </tr> </table>	1 Document	2 Voice	You can check whether your fax machine has received any Document or Voice messages. If yes, you will hear one long beep. If no, you will hear three short beeps.	
1 Document				
2 Voice				
<b>98 Change Answer Mode</b> <table border="1" data-bbox="213 475 423 587"> <tr> <td data-bbox="213 475 423 512">1 MC</td> </tr> <tr> <td data-bbox="213 512 423 549">2 F/T</td> </tr> <tr> <td data-bbox="213 549 423 587">3 FAX</td> </tr> </table>	1 MC	2 F/T	3 FAX	If you hear one long beep, you can change the answer mode. If you hear three short beeps, you cannot change it. (Example: There is no MC MSG when you want to change to MC mode.)
1 MC				
2 F/T				
3 FAX				
<b>90 Exit</b>	After a long beep, you can exit remote control.			

## Retrieving the Memory Status List

---

You can retrieve the Memory Status List from a remote fax machine to see if you have any fax messages.

- 1 Dial your fax machine's number.
- 2 When you hear the beep, immediately enter your Remote Access Code (3 digits followed by \*).
- 3 When you hear two short beeps, use the dial pad to press **9 6 1**.
- 4 Using the dial pad, enter the number (up to 20 digits) of the remote fax machine where you want the Memory Status List forwarded, and then press **# #**.



You cannot use \* and # as dial numbers. However, if you want to store a pause, press #.

- 5 After you hear your fax machine beep, hang up and wait.  
Your fax machine calls the remote fax machine and sends the Memory Status List. The remote fax machine prints the List.

## Retrieving Fax Messages

---

- 1 Dial your fax machine's number.
- 2 When you hear the beep, immediately enter your Remote Access Code (3 digits followed by \*).
- 3 As soon as you hear two short beeps, use the dial pad to press **9 6 2**.
- 4 Using the dial pad, enter the number (up to 20 digits) of the remote fax machine where you want your fax messages forwarded, and then press **# #**.



You cannot use \* and # as dial numbers. However, if you want to store a pause, press #.

- 5 After you hear your fax machine beep, hang up and wait.  
Your fax machine calls the remote fax machine and sends the stored documents. The remote fax machine prints your fax messages.

## Changing the Fax Forwarding Number

---

You can change the default setting of your fax forwarding number from a remote fax machine.

- 1** Dial your fax machine's number.
- 2** When you hear the beep, immediately enter your Remote Access Code (3 digits followed by \*).
- 3** When you hear two short beeps, use the dial pad to press **9 5 4**.
- 4** Enter the new number of the remote fax machine where you want your fax messages forwarded, and then press **##**.









You cannot use \* and # as dial numbers. However, if you want to store a pause, press #. Also, if your fax machine is connected to a PABX, you can press # first before the fax machine's number. The # works as well as **Recall** key. (Australia & New Zealand only)

- 5** To retrieve the Memory Status List, when you hear two short beeps, use the dial pad to press **9 6 1**.
- 6** Use the dial pad to enter the number of the remote fax machine (up to 20 digits), and then press **##**.
- 7** After you hear your fax machine beep, hang up and wait.  
Your fax machine calls the remote fax machine. Your fax machine then sends the Memory Status List showing the new forwarding number to the remote fax machine.
- 8** Check the forwarding number.  
If the forwarding number is incorrect, return to Step 1 to reset it.

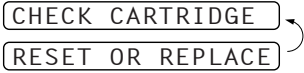
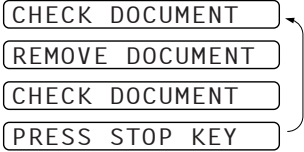
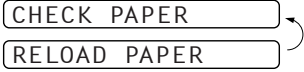
# 13 Troubleshooting and Maintenance

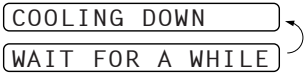
## Error Messages

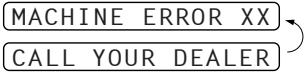
You may occasionally encounter a difficulty with your machine or telephone line. If this happens, your machine often identifies the problem and displays an error message. The list below explains the most common error messages.

ERROR MESSAGE	CAUSE/ACTION
	The machine is out of ribbon or the print cartridge is not properly installed. Install the print cartridge again. (See <i>Changing the Ribbon</i> , page 86.)
	The documents were not inserted or fed properly, or were too long. (See <i>Document Jam</i> , page 79.)
	The fax machine is out of paper or paper is not properly loaded in the paper tray. Refill the paper or remove the paper and load it again. If this error appears while receiving a fax, load paper to restart printing. If you were copying or printing reports, load paper and try again.
	A poor quality phone line resulted in a communications error. Try the call again.
	You have requested a polling call from another party, but the other fax machine is not in Poll Waiting mode. Verify the other parties polling setup.
	The print head has overheated. Wait 30 minutes for it to cool.
	The cover is not completely closed. Close the cover.
	The other party has disconnected during a call or fax.
	The fax machine has a mechanical problem. Unplug the machine. Then contact your Brother dealer for service.
	The number you called does not answer or is busy. You may also have reached a number not connected to a fax. Check the number and call again.

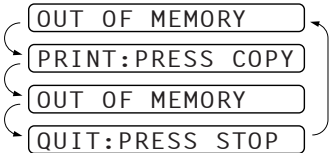
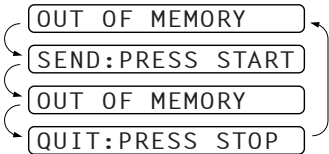
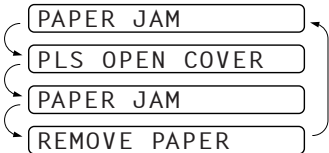
ERROR MESSAGE	CAUSE/ACTION
 <p>OUT OF MEMORY ERASE MESSAGE</p>	<p>The memory capacity has been exceeded. Print the faxes stored in memory to delete them. Then try again.</p>
 <p>OUT OF MEMORY PRINT:PRESS COPY OUT OF MEMORY QUIT:PRESS STOP</p>	<p>There is not enough memory available to perform your copy operation. Press <b>Stop/Exit</b>. Print the faxes stored in memory to delete them. Then try again. —<b>OR</b>—Press <b>Stop/Exit</b> to cancel the job. Then try again. (See <i>Cancelling a Scheduled Job</i>, page 58.)</p>
 <p>OUT OF MEMORY SEND:PRESS START OUT OF MEMORY QUIT:PRESS STOP</p>	<p>There is not enough memory available to send your fax. Press <b>Stop/Exit</b>. Print the faxes stored in memory to delete them. Then try again. —<b>OR</b>—Press <b>Stop/Exit</b> to cancel the job. Then try again. (See <i>Cancelling a Scheduled Job</i>, page 58.)</p>
 <p>PAPER JAM PLS OPEN COVER PAPER JAM REMOVE PAPER</p>	<p>The paper is jammed in the machine. (See <i>Paper Jam</i>, page 79.)</p>

# Document Jams and Paper Jams

## Document Jam

---

The documents were not inserted or fed properly, or were too long.

- 1 Remove any paper that is not jammed from the Automatic Document Feeder.
- 2 Open the top cover by lifting the lever on the right side of the top cover.
- 3 Pull the document toward the front of the machine.
- 4 Close the top cover.  
Press the both edges of the top cover and close it until it clicks.

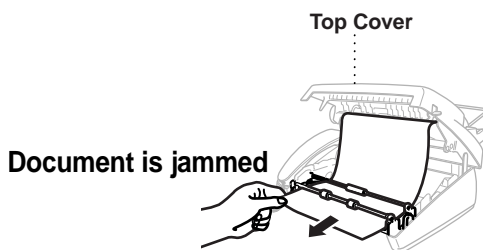

## Paper Jam

---

The recording paper is jammed in the machine.

- 1 Remove any paper that is not jammed.

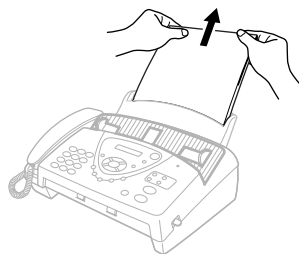



- 2** Open the top cover by lifting the lever on the right side of the top cover.

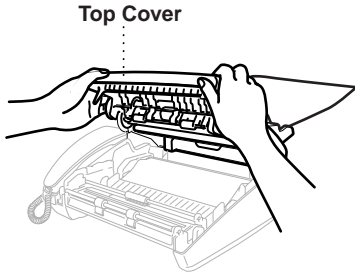
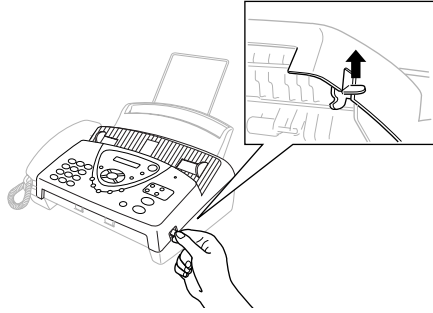

- 3** Pull the jammed printout gently from the paper tray toward the *front* of the machine. If the printout is jammed, then pull it toward the *back* of the machine.

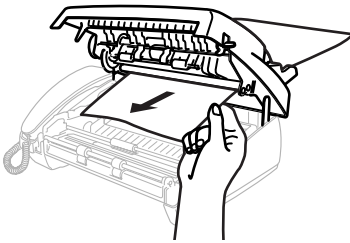

Printout is jammed

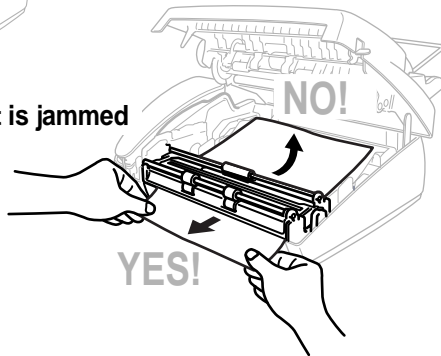

- 4** Remove the print cartridge and turn the spool to tighten the ribbon.  
**5** Install the cartridge. (See *Changing the Ribbon*, page 86.)  
**6** Close the top cover.  
Press the both edges of the top cover and close it until it clicks.  
**7** Put the recording paper back into the paper tray.

# Difficulty with Operation

If you think there is a problem with sending or printing quality of your fax machine, make a copy first. If the copy quality looks good then the problem may not be your fax machine. Check the difficulties below and follow the suggestions to help resolve your problems.

DIFFICULTY	SUGGESTIONS
<b>Printing or Receiving Faxes</b>	
Condensed Print and Horizontal Streaks; Top and Bottom of Sentences Cut Off	This can be caused by static or interference on the telephone line. You can make a copy using the Copy function and see if the same problem occurs. If the copy is also bad, call your Brother dealer for service.
Vertical Black Lines When Receiving	The sender's scanner may be dirty. Ask the sender to make a copy to see if the problem is with the sending machine. Try receiving from another fax machine. If the problem continues, contact the Brother dealer for service.
<b>Phone Line or Connections</b>	
Fax Machine Does Not Answer When Called	Make sure the machine is in the correct receiving mode for your setup (either FAX, F/T (FAX/TEL) or TAD). Check for dial tone. If possible, call your machine to hear it answer. If there is still no answer, check the telephone line cord connection. Connect a standard telephone handset to the machine's telephone jack. If there is no ringing when you call your machine, call your Telephone Company to check the line.
No Dial Tone on the Handset	Press <b>Speaker Phone</b> (for FAX-737MC only)— <b>OR</b> —Lift the handset. If you hear no dial tone, check telephone line cord connections at the machine and wall jack. Check that the handset is connected to the machine's handset jack. Test the wall jack with another single line telephone. If no dial tone on the wall outlet, call your Telephone Company.
<b>Sending Faxes</b>	
Poor Transmitting Quality	Try changing your resolution to FINE or S.FINE. (See <i>Resolution</i> , page 20.) Make a copy to verify the machine's scanner operation.
Dialling Does Not Work	Check for a dial tone. Change <b>TONE/PULSE</b> setting. (See <i>Setting the Dialling Mode (Tone/Pulse)</i> (Not available in New Zealand), page 12.) Check all line cord connections. Check power cord connection. Send a manual fax by pressing <b>Speaker Phone</b> (for FAX-737MC only)— <b>OR</b> —Lifting the handset, and dialling the number. Wait to hear fax receiving tones before pressing <b>Fax Start</b> .

MAINTENANCE

DIFFICULTY	SUGGESTIONS
Vertical Black Lines When Sending	Use your machine to make a copy. If the copy shows the same problem, the scanner area is dirty. Lift the front cover and check the document path. Clean the scanner's white roller and the glass strip under the roller using isopropyl alcohol and a lint-free cloth.
<b>Handling Incoming Calls</b>	
F/T Pseudo-Ring in F/T Mode	The machine knows the incoming call is not a fax so it is signalling you to answer the voice call. Pick up the machine's handset or answer from an extension phone and press your machine's Telephone Answer Code (default setting is # 5 1 (# 9 1 for New Zealand)).
Transferring a Call to the Machine	If you have answered at the machine's handset, press <b>Fax Start</b> , and hang up immediately. If you answered at an extension phone, press your three-digit Fax Receive Code (the factory setting is * 5 1 (* 9 1 for New Zealand)). When your machine answers, hang up.
Machine goes into receive mode when the caller is not a fax	If the machine is set to Fax Detect ON, it is more sensitive to sounds. The machine may mistakenly interpret certain voices or music on the line as a calling fax machine and respond with fax receiving tones. Deactivate the fax by pressing <b>Stop/Exit</b> . Try avoiding this problem by turning Fax Detect to OFF. (See <i>Fax Detect</i> , page 26.)
Transmission Verification Report Prints "RESULT:ERROR"	There is probably temporary noise or static on the phone line. Try sending the fax again. If the problem continues, call the Telephone Company to check your phone line.

# Regular Maintenance

## Cleaning the Scanner

---

- 1 Unplug the power cord for safety.
- 2 Open the top cover by lifting the lever on the right side of the top cover.
- 3 Clean the white bar and the glass strip under the bar with isopropyl alcohol on a lint-free cloth. Be careful not to bend the spring plate or drop anything into the machine.

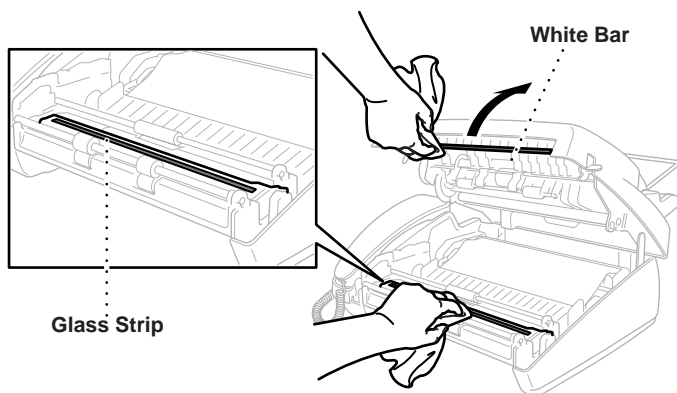

- 4 Close the top cover.  
Press the both edges of the top cover and close it until it clicks.

## Cleaning the Print Head

---



### WARNING

After you have just used the machine, some internal parts of the machine are extremely **HOT!** So please be careful.

- 1 Unplug the power cord for safety.
- 2 Open the top cover by lifting the lever on the right side of the top cover.



Be careful not to cut yourself on the sharp edges of the metal part shown in the illustration.

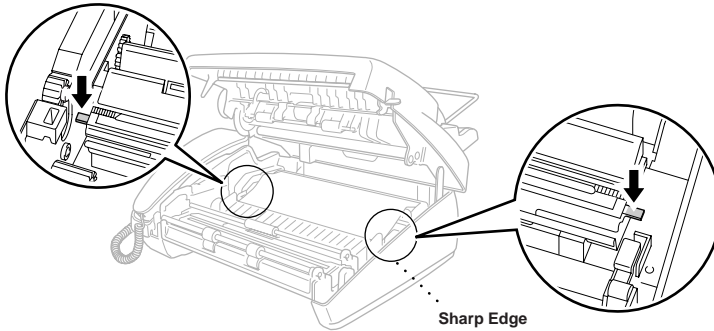

- 3 Take out the printing cartridge.

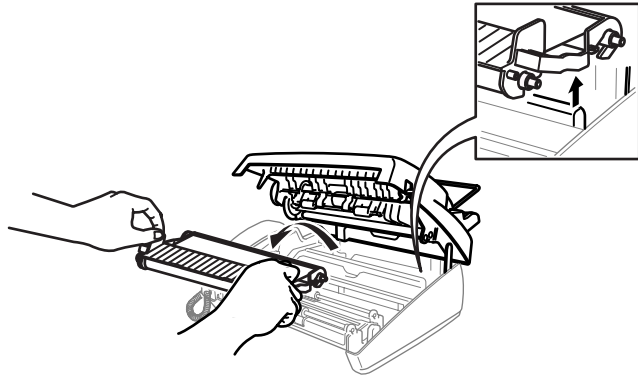

- 4 To clean the machine's print head, wipe the print head with a lint-free cloth that is dry or lightly moistened with isopropyl alcohol.

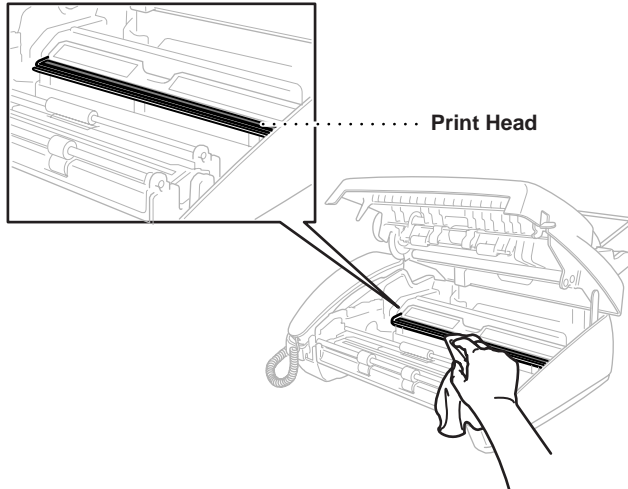

- 5 Wait until the alcohol on the print head is totally dried.
- 6 Install the printing cartridge. (See *Changing the Ribbon*, page 86.)
- 7 Press both edge of the top cover until it clicks and close the top cover.

## Changing the Ribbon

---

- 1 Open the top cover by lifting the lever on the right side of the top cover.

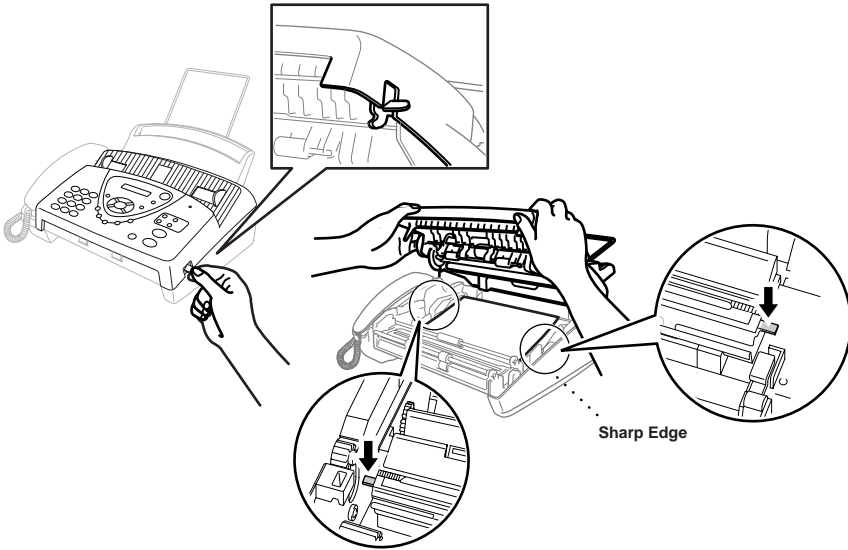

Be careful not to cut yourself on the sharp edges of the metal part shown in the illustration.

- 2 Remove the print cartridge containing the used ribbon and set it upside—down with the blue gear in the upper left corner.

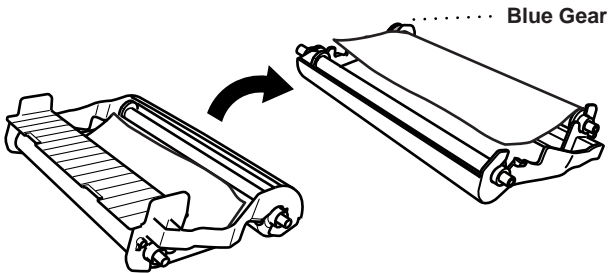

**3** Take the used ribbon out of the cartridge:

- ① Snap out the upper white spool and slide the roll off the blue gear. (Do not remove the blue gear)
- ② Lift out the lower roll.

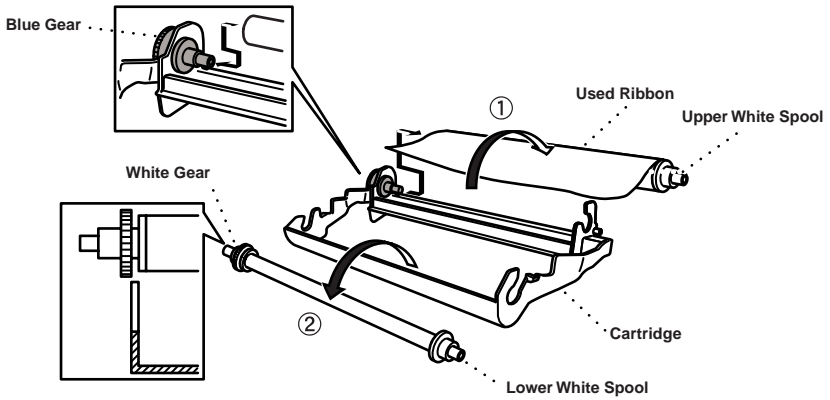

**4** Slide the white elastic off the new refill rolls and set them down with the full roll in the lower position. (The ribbon's shiny side is facing *down*.)

**5** Remove the white gear and spools from the ends of the used cardboard cores. Then insert them into the same positions in the new cores.

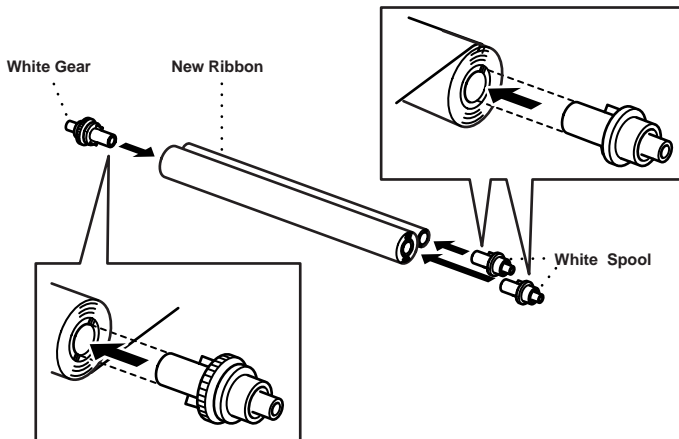



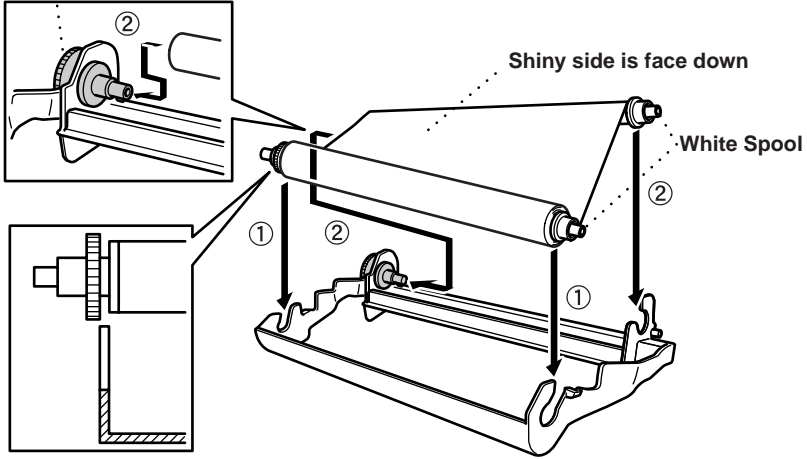

- 6** Install the new ribbon back into the cartridge:
- ① Insert the lower roll into the cartridge holders.
  - ② Skip the upper left cardboard onto the blue gear of the cartridge and insert the upper roll into the cartridge holders.

**Blue Gear**

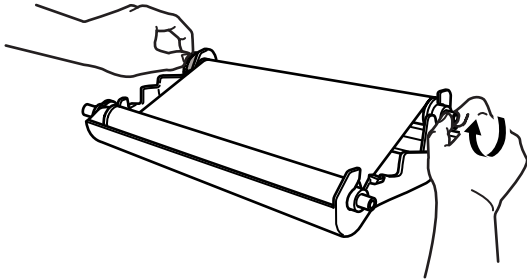

- 7** Turn the upper right white spool *clockwise* to tighten the ribbon, as shown.



- 8** Turn the cartridge over and re-install it into the machine: Insert the recessed  first and place the cartridge into its four holders.

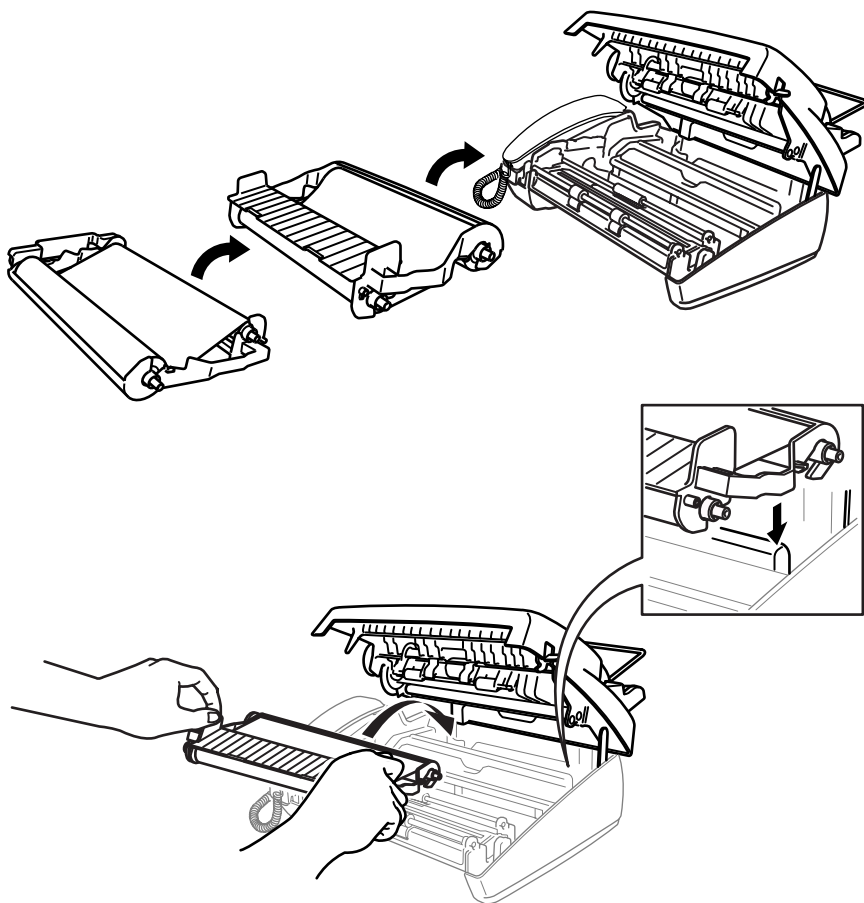

- 9** Press down on both sides of the top cover to close it securely.

# Packing and Shipping the Machine

Whenever you transport the fax machine, use the packing materials that came with your fax machine. Failure to pack the machine properly may damage the machine and such damages will not be covered under warranty.

- 1 Unplug the fax machine from the AC power outlet.



Do not unplug the fax machine after a print job until you hear the final click.

- 2 Remove the paper wire extension, telephone line cord, print cartridge and handset, and pack them.



If you are returning the fax machine to Brother as part of the Brother Exchange Service, pack *only* the fax machine. Keep all separate parts to use with your "Exchange" machine.

- 3 Wrap the fax machine in the plastic bag and place it in the original carton with the original packing material.

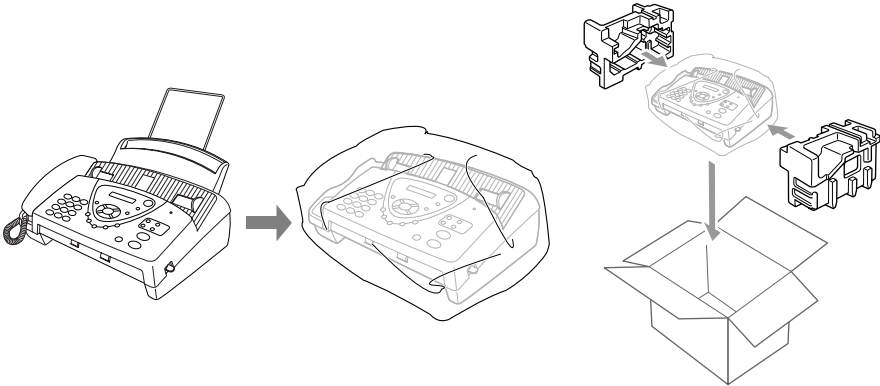

# 14 Important Safety Information

## *Important Information for Australia*

### Important Safety Instructions

---

- 1 Read all of these instructions.
- 2 Save them for later reference.
- 3 Follow all warnings and instructions marked on the product.
- 4 Unplug this product from the telephone and AC sockets (in this order) before cleaning. Do not use liquid or aerosol cleaners. Use a damp cloth for cleaning.
- 5 Do not place this product on an unstable surface.
- 6 Do not use this product near water.
- 7 Slots and openings in the case and the back or bottom are provided for ventilation; to ensure reliable operation of the product and to protect it from overheating, these openings must not be blocked or covered. The openings should never be blocked by placing the product on a bed, sofa, rug, or other similar soft surface. This product should never be placed near or over a radiator or heater. This product should not be placed in a built-in installation unless proper ventilation is provided.
- 8 This product should be operated from the type of power source indicated on the label. If you are not sure of the type of power available, consult with your dealer or local power company.
- 9 This product is equipped with a 3-wire earthed plug. This plug will fit into only an earthed socket. This is a safety feature. If you are unable to insert the plug into the outlet, contact your electrician to replace your obsolete socket. Do not defeat the purpose of an earthed plug.
- 10 Do not allow anything to rest on the power cord. Do not locate this product where people can walk on the cord.
- 11 Do not place anything in front of the machine that will block received faxes. Do not place anything in the path of received faxes.
- 12 Do not touch a document during printing.
- 13 Never push objects of any kind into this product through cabinet slots, since they may touch dangerous voltage points or short out parts resulting in a risk of fire or electric shock. Never spill liquid of any kind on the product.
- 14 Do not attempt to service this product yourself, because opening or removing covers may expose you to dangerous voltage points and/or other risks. Refer all servicing to service personnel.
- 15 This product has no mains ON/OFF switch. It is therefore highly important that access to the mains plug and the mains socket to which the plug is connected, is never obstructed, in case for some reason the mains power to the machine must be quickly disconnected.

- 16** Unplug this product from the mains power and telephone line sockets, and refer servicing to qualified service personnel under the following conditions:
- ◆ When the power cord is damaged or frayed.
  - ◆ If liquid has been spilled into the product.
  - ◆ If the product has been exposed to rain or water.
  - ◆ If the product does not operate normally when the operating instructions are followed. Adjust only those controls that are covered by the operating instructions. Improper adjustment of other controls may result in damage and will often require extensive work by a qualified technician to restore the product to normal operation.
  - ◆ If the product has been dropped or the cabinet has been damaged.
  - ◆ If the product exhibits a distinct change in performance, indicating a need for service.
- 17** We do not advise the use of an extension lead.

## ***Important Information for New Zealand***

### **Important Safety Instructions**

---

- 1** Read all of these instructions.
- 2** Save them for later reference.
- 3** Follow all warnings and instructions marked on the product.
- 4** Unplug this product from the telephone and AC sockets (in this order) before cleaning. Do not use liquid or aerosol cleaners. Use a damp cloth for cleaning.
- 5** Do not use this product near water.
- 6** The grant of a Telepermit for any item of terminal equipment indicates only that Telecom has accepted that the item complies with minimum conditions for connection to its network. It indicates no endorsement of the product by Telecom, nor does it provide any sort of warranty. Above all, it provides no assurance that any item will work correctly in all respects with another item of Telepermitted equipment of a different make or model, nor does it imply that any product is compatible with all of Telecom's network services.
- 7** This equipment does not fully meet Telecom's impedance requirements. Performance limitations may occur when used in conjunction with some parts of the network. Telecom will accept no responsibility should difficulties arise in such circumstances.
- 8** If a charge for local calls is unacceptable, the "Dial Button" should not be used for local calls. Only the 7-digits of the local number should be dialled from your telephone. Do not dial the area code digit or the "0" prefix.
- 9** This equipment shall not be set to make automatic calls to the Telecom '111' Emergency Service.
- 10** **IMPORTANT NOTICE**  
Under power failure conditions, this telephone may not operate. Please ensure that a separate telephone, not dependent on local power, is available for emergency use in emergencies.
- 11** The call log incorporated in this equipment does not record all answered calls. The call log, therefore may not agree with the Telecom account which may include calls not shown on the log.

- 12** Some parameters required for compliance with Telecom's Telepermit requirements are dependent on the equipment (PC) associated with this device. In order to operate within the limits for compliance with Telecom's Specifications, the associated equipment shall be set to ensure that automatic calls to different numbers are spaced such that there is no less than 5 seconds between the end of one call attempt and the beginning of another.
- 13** Some parameters required for compliance with Telecom's Telepermit requirements are dependent on the equipment (PC) associated with this device. In order to operate within the limits for compliance with Telecom's Specifications, the associated equipment shall be set to ensure that calls are answered between 3 and 30 seconds of receipt of ringing.
- 14** This equipment should not be used under any circumstances which may constitute a nuisance to other Telecom customers.
- 15** Not all telephones will respond to incoming ringing when connected to the extension socket.
- 16** This equipment may not provide for the effective hand-over of a call to another device connected to the same line.
- 17** The answer delay setting of this equipment shall not be set to less than two rings to answer as this will destroy Caller ID information.
- 18** All persons using this device for recording telephone conversations shall comply with New Zealand law. This requires that at least one party to the conversation is to be aware that it is being recorded. In addition, the Principles enumerated in the Privacy Act 1993 shall be complied with in respect to the nature of the personal information collected, the purpose for its collection, how it is to be used and what it disclosed to any other party.
- 19** The Caller ID Information is presented in the form: Area Code + Directory number  
When dialling back, always insert a zero in front of the area code for a toll call and omit the area code for a local call. If a zero is inserted in front of the area code for a local call, the call will still proceed correctly but if the line has non-code access to another toll carrier, you should check with that carrier before inserting zero on a local call.
- 20** Do not place this product on an unstable surface.
- 21** Slots and openings in the case and the back or bottom are provided for ventilation; to ensure reliable operation of the product and to protect it from overheating, these openings must not be blocked or covered. The openings should never be blocked by placing the product on a bed, sofa, rug, or other similar soft surface. This product should never be placed near or over a radiator or heater. This product should not be placed in a built-in installation unless proper ventilation is provided.
- 22** This product should be operated from the type of power source indicated on the label. If you are not sure of the type of power available, consult with your dealer or local power company.
- 23** This product is equipped with a 3-wire earthed plug. This plug will fit into only an earthed socket. This is a safety feature. If you are unable to insert the plug into the outlet, contact your electrician to replace your obsolete socket. Do not defeat the purpose of an earthed plug.
- 24** Do not allow anything to rest on the power cord. Do not locate this product where people can walk on the cord.
- 25** Do not place anything in front of the machine that will block received faxes. Do not place anything in the path of received faxes.
- 26** Do not touch a document during printing.

- 27** Never push objects of any kind into this product through cabinet slots, since they may touch dangerous voltage points or short out parts resulting in a risk of fire or electric shock. Never spill liquid of any kind on the product.
- 28** Do not attempt to service this product yourself, because opening or removing covers may expose you to dangerous voltage points and/or other risks. Refer all servicing to service personnel.
- 29** This product has no mains ON/OFF switch. It is therefore highly important that access to the mains plug and the mains socket to which the plug is connected, is never obstructed, in case for some reason the mains power to the machine must be quickly disconnected.
- 30** Unplug this product from the mains power and telephone line sockets, and refer servicing to qualified service personnel under the following conditions:
- ◆ When the power cord is damaged or frayed.
  - ◆ If liquid has been spilled into the product.
  - ◆ If the product has been exposed to rain or water.
  - ◆ If the product does not operate normally when the operating instructions are followed. Adjust only those controls that are covered by the operating instructions. Improper adjustment of other controls may result in damage and will often require extensive work by a qualified technician to restore the product to normal operation.
  - ◆ If the product has been dropped or the cabinet has been damaged.
  - ◆ If the product exhibits a distinct change in performance, indicating a need for service.
- 31** We do not advise the use of an extension lead.
- 32** This device only responds to Distinctive Alert Cadences DA1, DA2 and DA4.
- 33** Configuration of the machine with Faxability ON will result in Caller ID information being destroyed when ring cadence DA4 is received.

# Important Information for Some Countries

## Important Safety Instructions

---

- 1** Read all of these instructions.
- 2** Save them for later reference.
- 3** Follow all warnings and instructions marked on the product.
- 4** Unplug this product from the wall outlet before cleaning. Do not use liquid or aerosol cleaners. Use a damp cloth for cleaning.
- 5** Do not place this product near water.
- 6** Do not place this product on an unstable cart, stand, or table. The product may drop, causing serious damage to the product.
- 7** Slots and openings in the cabinet and the back or bottom are provided for ventilation; to ensure reliable operation of the product and to protect it from overheating, these openings must not be blocked or covered. The openings should never be blocked by placing the product on a bed, sofa, rug, or other similar surface. This product should never be placed near or on a radiator or heater. This product should never be placed in a built-in installation unless proper ventilation is provided.
- 8** This product should be operated from the type of power source indicated on the label. If you are not sure of the type of power available, consult with your dealer or local power company.
- 9** This product is equipped with a 2-wire grounding type plug and a 3-wire grounding type plug, a plug having two or three pins. This plug will only fit into only a grounding-type power outlet. This is a safety feature. If you are unable to insert the plug into the outlet, contact your electrician to replace your obsolete outlet. Do not defeat the purpose of the grounding-type plug.
- 10** Do not allow anything to rest on the power cord. Do not place this product where people can walk on the cord.
- 11** If an extension cord is used with this product, make sure that the total ampere ratings on the products plugged into the extension cord do not exceed the extension cord ampere rating.
- 12** Do not place anything in front of the machine that will block received faxes. Do not place anything in the path of received faxes.
- 13** Do not touch a document during printing.
- 14** Never push objects of any kind into this product through cabinet slots, since they may touch dangerous voltage points or short out parts resulting in the risk of fire or electric shock. Never spill liquid of any kind on the product.



- 15** Do not attempt to service this product yourself, as opening or removing covers may expose you to dangerous voltage points and/or other risks, and may not be covered under your warranty. Please refer all servicing to our Authorized Service Personnel. A list of Authorized Service Centres has been included for your convenience, or you may contact the Brother Dealer for Service.
- 16** This product has no mains ON/OFF switch. It is therefore highly important that access to the mains plug and the mains socket to which the plug is connected, is never obstructed, in case for some reason the mains power to the machine must be quickly disconnected.
- 17** Unplug this product from the wall outlet and refer servicing to Authorized Service Personnel under the following conditions:
- ◆ If the power cord is damaged or frayed.
  - ◆ If the product has been spilled by liquid.
  - ◆ If the product has been exposed to rain or water.
  - ◆ If the product does not operate normally when the operating instructions are followed. Adjust only those controls that are covered by the operating instructions. Improper adjustment of other controls may result in damage and will often require extensive work by a qualified technician to restore the product to normal operation.
  - ◆ If the product has been dropped or the cabinet has been damaged.
  - ◆ If the product exhibits a distinct change in performance, indicating a need for service.
- 18** To protect your product against power surges, we recommend the use of a power protection device (Surge Protector).
- 19** We do not advise the use of an extension lead.



- **For protection against the risk of electrical shock, always disconnect all cables from the wall outlet before servicing, modifying or installing the equipment.**
- **This equipment may not be used on coin service lines provided by the telephone company or connected to party lines.**
- **Brother cannot accept any financial or other responsibilities that may be the result of your use of this information, including direct, special or consequential damages. There are no warranties extended or granted by this document.**

## **For Your Safety**

To ensure safe operation the three-pin plug supplied must be inserted only into a standard three-pin power point which is effectively grounded through the normal household wiring.

The fact that the equipment operates satisfactorily does not imply that the power is grounded and that the installation is completely safe. For your safety, if in any doubt about the effective grounding of the power, consult a qualified electrician.

## **Disconnect device**

This product must be installed near a socket outlet that is easily accessible. In case of emergencies, you must disconnect the power cord from the socket outlet in order to shut off power completely.

# 15 Specifications

## Specifications

<b>Type</b>	Desktop facsimile transceiver
<b>Compatibility</b>	ITU-T Group 3
<b>Coding system</b>	Modified Huffman (MH)
<b>Modem speed</b>	9600/7200/4800/2400; Automatic Fallback (FAX-717, FAX-727) 14400/12000/9600/7200/4800/2400; Automatic Fallback (FAX-737MC)
<b>Document size</b>	Width: 148 mm to 216 mm Length: 150 mm to 600 mm Weight: 64 gsm <sup>2</sup> to 90 gsm <sup>2</sup>
<b>Paper size</b>	Width: 210 mm (A4) Length: Up to 356 mm Weight: 64 gsm <sup>2</sup> to 90 gsm <sup>2</sup>
<b>Scanning/Printing width</b>	208 mm
<b>Paper tray</b>	Up to 30 sheets (75 gsm <sup>2</sup> )
<b>Printer type</b>	Line thermal with ribbon
<b>Grey scale</b>	64 levels (Dithered)
<b>Display</b>	LCD, 16 characters
<b>Polling types</b>	Standard, Secure, Delayed, Sequential
<b>Contrast control</b>	Automatic/Light/Dark (Manual setting)
<b>Resolution</b>	<ul style="list-style-type: none"><li>• Horizontal 8 dot/mm</li><li>• Vertical Standard—3.85 line/mm Fine, Photo—7.7 line/mm Superfine, Photo (copy)—15.4 line/mm</li></ul>
<b>Memory capacity</b>	512 KB
<b>One touch dial</b>	4 stations
<b>Speed dial</b>	100 stations (FAX-727/737MC) 60 stations (FAX-717)
<b>Groups</b>	Up to 4
<b>Automatic redial</b>	3 times at 5 minute intervals
<b>Speaker type</b>	Full Duplex, Digital (FAX-737MC) Monitor (FAX-717/727)

<b>Automatic answer</b>	2, 3, 4, 5, 6, 7, 8, 9 or 10 rings (for Australia) 1, 2, 3, 4, 5, 6, 7, 8, 9 or 10 rings (for New Zealand) 0, 1, 2, 3, 4, 5, 6, 7, 8, 9 or 10 rings (for some countries)
<b>Communication source</b>	Public switched telephone network
<b>Operating environment</b>	5 – 35°C
<b>Power source</b>	220-240 V AC 50/60 Hz
<b>Power consumption</b>	Standby: under 5 watts — Peak: under 170 watts
<b>Dimensions</b>	334(W) x 301(D) x 281(H) (mm)
<b>Weight</b>	3.5 kg

Specifications are subject to change for improvement without prior notice.

\*“Pages” refers to the ITU-T Test Chart No.1 (in Out of Paper Reception in ECM mode).

# Menu Mode & Menu Selection Table

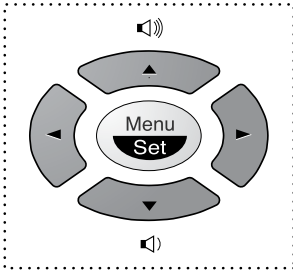

- Access the Menu
- Go to next menu level
- Accept an option
- Scroll through the current menu level
- Back to previous menu level
- Forward to next menu level
- Exit the Menu

You can access the menu mode by pressing **Menu/Set**.  
When you enter the Menu, the LCD scrolls:

Press **1** for Initial Setup Menu—**OR**—

Press **2** for Setup Receive Menu—**OR**—

Press **3** for Setup Send Menu—**OR**—

Press **4** for Cancel Job Menu—**OR**—

Press **5** for Interrupt Menu—**OR**—

Press **6** for Set Quick-Dial Menu—**OR**—

Press **7** for Report Setting Menu—**OR**—

Press **8** for Remote Fax Options Menu (FAX-717/727)  
—**OR**—

Press **8** for Setup Message Centre Menu (FAX-737MC)  
—**OR**—

Press **9** for Setup Melody Menu (FAX-737MC)—**OR**—

Press **0** for Miscellaneous Menu—**OR**—

SELECT ↑ ↓ & SET

1. INITIAL SETUP

2. SETUP RECEIVE

3. SETUP SEND

4. CANCEL JOB

5. INTERRUPT

6. SET QUICK-DIAL

7. REPORT SETTING

8. REMOTE FAX OPT

8. SETUP MSG CTR

9. SETUP MELODY

0. MISCELLANEOUS

You can scroll more quickly through each menu level by pressing or keys, and then set an option by pressing **Menu/Set** when that option appears on the LCD. Then the LCD shows next menu level. Press or key to scroll to your next menu selection, and then press **Menu/Set**. When you finish setting an option, the LCD shows **ACCEPTED**.







Use to scroll backward if you passed your choices or to save keystrokes.

You can program the machine by pressing **Menu/Set** followed by the menu numbers. For example: to set **RESOLUTION** to **FINE**, press **Menu/Set, 3, 4** and or to select **FINE**, and then press **Menu/Set**.

To access the menu, press  **Menu/Set**.



To exit, press  **Stop/Exit**.

Main Menu	Menu Selections	Options	Descriptions	Page
				
<b>1. INITIAL SETUP</b>	<b>1. TONE/PULSE</b> (Not available in New Zealand)	TONE PULSE	Select the dialling mode.	12
	<b>2. DATE/TIME</b>	—	Enter date and time for LCD display and to print on transmissions.	12
	<b>3. STATION ID</b>	—	Program the name, fax number and telephone number to appear on each transmitted page.	13
	<b>4. BEEPER</b>	OFF LOW HIGH	Adjust the volume level of the beeps when you press a key, an error occurs or a document is sent or received.	14
	<b>5. PBX</b> (Australia & New Zealand only)	ON OFF	Turn on if PABX (Private Automatic Branch Exchange) is connected to your machine.	15
<b>2. SETUP RECEIVE</b>	<b>1. RING DELAY</b>	10 09 08 07 06 05 04 03 (Example for 02 Australia) TOLL SAVER:OFF (FAX-737MC Only)	Sets the number of rings before the machine answers in F/T, FAX or TAD (Message Centre) mode.	24
	<b>2. F/T RING TIME</b>	70 40 30 20	Sets the time for "F/T pseudo-ring" in Fax/Tel (F/T) Mode.	25
	<b>3. FAX DETECT</b>	ON SEMI OFF	Receive fax messages without pressing the <b>Fax Start</b> key.	26

\* The factory setting (option) is shown in bold.

To access the menu, press  **Menu/Set**.

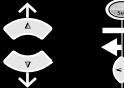
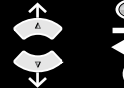
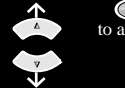
To exit, press  **Stop/Exit**.

<b>Main Menu</b> 	<b>Menu Selections</b> 	<b>Options</b> 	<b>Descriptions</b> to accept 	<b>Page</b>
<b>2. SETUP RECEIVE (Continued)</b>	<b>4. REMOTE CODE</b>	<b>ON</b> (*51, #51, *81) (*91, #91, *81 for New Zealand) <b>OFF</b>	Enter code to activate or deactivate machine from a remote location or to transfer voice call from cordless phone to the machine.	46
	<b>5. REDUCTION</b>	<b>AUTO</b> 100% 93% 87% 75%	Reduces size of image.	26
	<b>6. MEM.RECEIVE</b>	<b>ON</b> <b>OFF</b>	Automatically stores any incoming faxes in its memory if it runs out of paper.	27
	<b>7. POLLING RX</b>	<b>STANDARD</b> <b>SECURE</b> <b>TIMER</b>	You call another fax machine to receive a fax from it.	56
<b>3. SETUP SEND</b>	<b>1. COVERPG SETUP (FAX-727/737MC Only)</b>	<b>NEXT FAX ONLY</b> <b>ON</b> <b>OFF</b> PRINT SAMPLE	Automatically sends a programmable cover page or prints a sample coverpage.	35
	<b>2. COVERPAGE NOTE (FAX-727/737MC Only)</b>	—	Program a customized message for fax cover page.	37
	<b>3. CONTRAST</b>	<b>AUTO</b> LIGHT DARK	Change the lightness or darkness of a fax you are sending.	20
	<b>4. RESOLUTION</b>	<b>STANDARD</b> FINE S.FINE PHOTO	Allows you to change resolutions page by page.	43
	<b>5. OVERSEAS MODE</b>	<b>ON</b> <b>OFF</b>	Special setting for international transmissions.	37
	<b>6. CALL RESERVE (FAX-727/737MC Only)</b>	<b>ON</b> <b>OFF</b> PRINT SAMPLE	You can send a fax, then speak or print a sample call back message.	38

\* The factory setting (option) is shown in bold.

To access the menu, press  **Menu/Set**.

To exit, press  **Stop/Exit**.

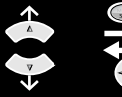
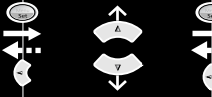
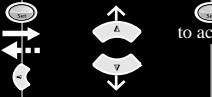

<b>Main Menu</b> 	<b>Menu Selections</b> 	<b>Options</b> 	<b>Descriptions</b> to accept	<b>Page</b>
<b>3. SETUP SEND (Continued)</b>	<b>7. TIMER</b>	—	Set the machine to send your documents later.	39
	<b>8. POLLED TX</b>	<b>STANDARD SECURE</b>	Set Polled Transmission for someone to poll the machine to receive a fax from you.	58
	<b>9. MEMORY TX</b>	<b>NEXT FAX ONLY ON OFF</b>	You can send faxes from memory.	37
<b>4. CANCEL JOB</b>	—	—	Cancel a delayed fax or polling job.	40, 58
<b>5. INTERRUPT</b>	—	—	Send a fax now, even if you have the machine set to send a fax later, or if you have it set for Polling.	40
<b>6. SET QUICK-DIAL</b>	<b>1. ONE-TOUCH DIAL</b>	—	Dial numbers stored in memory by pressing only one key.	17
	<b>2. SPEED-DIAL</b>	—	Dial numbers stored in memory by pressing only four keys.	18
	<b>3. SETUP GROUPS</b>	—	Set up a Group number for broadcasting.	19
<b>7. REPORT SETTING</b>	<b>1. XMIT REPORT</b>	<b>ON OFF</b>	Initial setup for Transmission Verification Report and Journal period.	33
	<b>2. JOURNAL PERIOD</b>	<b>EVERY 30 FAXES EVERY 6 HOURS EVERY 12 HOURS EVERY 24 HOURS EVERY 2 DAYS EVERY 7 DAYS OFF</b>		33

\* The factory setting (option) is shown in bold.

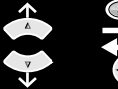
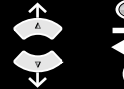
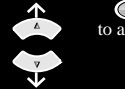

To access the menu, press  **Menu/Set**.

To exit, press  **Stop/Exit**.

<b>Main Menu</b> 	<b>Menu Selections</b> 	<b>Options</b> 	<b>Descriptions</b> to accept 	<b>Page</b>
<b>8. REMOTE FAX OPT (FAX-717/727 Only)</b>	<b>1. FAX FWD</b>	ON <b>OFF</b>	Set the machine to forward faxes.	60
	<b>2. FAX STORAGE</b>	ON <b>OFF</b>	Store incoming faxes in memory for fax forwarding and remote retrieval.	60
	<b>3. REMOTE ACCESS</b>	--- *	Set code for retrieving faxes.	61
	<b>4. PRINT DOCUMENT</b>	—	Print incoming faxes stored in the memory.	27
<b>8. SETUP MSG CTR (FAX-737MC Only)</b>	<b>1. MESSAGE STORE</b>	DOC:ON <b>DOC:OFF</b> VOICE:ON VOICE:EXT VOICE:OFF	Select if memory will store fax, voice or both.	66
	<b>2. BACKUP PRINT</b>	ON OFF	Automatically prints a copy of faxes received into memory.	68
	<b>3. OGM</b>	<b>MSG CTR OGM</b> FAX/TEL OGM PAGING OGM	Select/Record outgoing message.	25, 66
	<b>4. ICM MAX.TIME</b>	20-60 seconds (Factory setting is <b>30</b> seconds)	Select maximum length of incoming messages.	69
	<b>5. ICM REC.MONITR</b>	ON OFF	Select <b>ON</b> or <b>OFF</b> for voice messages as they come in.	70
	<b>6. FAX FWD/PAGING</b>	<b>OFF</b> FAX FORWARD PAGING	Set fax machine to forward fax/message— <b>OR</b> —to call your pager.	70
	<b>7. REMOTE ACCESS</b>	--- *	Set code for retrieving messages.	72

\* The factory setting (option) is shown in bold.

To access the menu, press  **Menu/Set**.

To exit, press  **Stop/Exit**.

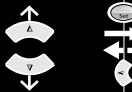
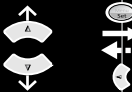
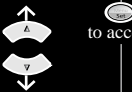
<b>Main Menu</b> 	<b>Menu Selections</b> 	<b>Options</b>  to accept	<b>Descriptions</b>	<b>Page</b>
<b>9. SETUP MELODY (FAX-737MC Only)</b>	<b>1. RING PATTERN</b>	<b>SIGNAL</b> MELODY1 MELODY2 MELODY3 MELODY4	Selects ring pattern.	16
	<b>2. MUSIC ON HOLD</b>	<b>OFF</b> <b>MELODY1</b> MELODY2 MELODY3 MELODY4	Selects the music type or sets to off the music on hold.	16
	<b>3. MELODY ALARM</b>	<b>OFF</b> <b>ON</b> (SIGNAL MELODY1 MELODY2 MELODY3 MELODY4)	Set the machine to alarm the melody later— <b>OR</b> —select the music type for melody alarm.	16
<b>0. MISCELLANEOUS</b>	<b>1. MEM SECURITY</b>	—	Prohibits most functions except receiving faxes into memory.	41
	<b>2. CALLER ID</b>	DISPLAY ID PRINT REPORT	View and dial back, or print a list of the last 30 Caller IDs stored in memory.	48
	<b>3. DISTINCTIVE (Not available in New Zealand)</b>	ON <b>OFF</b>	Use with phone company distinctive ringing service to register the ring pattern with the machine.	47
	<b>3. FAXABILITY (Only for New Zealand)</b>	ON <b>OFF</b>	If you have FaxAbility from Telecom, you can use this function to store the ringing pattern of your fax number. And if you set it to ON, you should use the registered number as a fax number only.	50

\* The factory setting (option) is shown in bold.

# Entering Text

When you are setting certain functions, such as the Station ID, you may need to enter text into the machine. Most keys on the dial pad have three or four letters printed above them. The keys for 0, #, and \* don't have printed letters because they are used for special characters.

By pressing the appropriate number on the dial pad the correct number of times, you can access the character you want.

Press Key	once	twice	three times	four times	five times
2	A	B	C	2	A
3	D	E	F	3	D
4	G	H	I	4	G
5	J	K	L	5	J
6	M	N	O	6	M
7	P	Q	R	S	7
8	T	U	V	8	T
9	W	X	Y	Z	9

## Inserting spaces

If you want to enter a blank space, press  twice.

## Making corrections

If you entered a letter incorrectly and want to change it, press  to move the cursor after the last correct letter. Then press **Stop/Exit** all letters above and to the right of the cursor are deleted. Re-enter the correct text and/or digits. You can also back up and type over incorrect letters.

## Repeating letters

If you need to enter a character assigned to the same key as the previous character, press  to move the cursor to the right.

## Special characters and symbols

Press \*, # or 0 repeatedly or press  to move the cursor under the special character or symbol you want. Then press **Menu/Set** to select it.

Press \* for (space) ! " # \$ % & ' ( ) \* + , - . /

Press # for : ; < = > ? @ [ ] ^ \_

Press 0 for Ä Ë Ö Ü À Ç È É 0

# About Fax Machines

If you are a first-time fax machine user, fax operation might seem a little mysterious. You will soon get used to the unusual fax tones on your phone line, and be able to send and receive faxes easily.

## Fax Tones and Handshake

---

When someone is sending a fax, the fax machine sends fax calling tones, (CNG tones)—soft, beeps at 4-second intervals. You will hear them when you dial and press **Fax Start**, and they continue for about 60 seconds after dialling. During that time, the sending machine must begin the “handshake” with the receiving machine. Each time you use automatic procedures to send a fax, you are sending CNG tones over the phone line. You will soon learn to listen for these soft beeps each time you answer a phone on your fax line, so you can know if you are receiving a fax message.

The receiving fax responds with fax receiving tones—loud, chirping sounds. A receiving fax chirps for about 40 seconds over the phone line, and the screen displays **RECEIVE**. If your fax machine is set to the **FAX ONLY** Mode, it will answer every call automatically with fax receiving tones. Even if the other party hangs up, your fax machine continues to send the “chirps” for about 40 seconds, and the screen continues to display **RECEIVE**. To cancel the receiving mode, press **Stop/Exit**.

When your fax machine is in **FAX/TEL (F/T)** mode, it answers with a short beep. After this beep, the fax machine listens for CNG tones, and, if heard, it will respond with receiving tones.

The fax “handshake” is the time in which the sending machine’s CNG tones and the receiving machine’s “chirps” overlap. This must be for at least 2 to 4 seconds, so the fax machines can understand how each is sending and receiving the fax. The handshake cannot begin until the call is answered, and the CNG tones only last for about 60 seconds after the number is dialled. Therefore, it’s important for the receiving machine to answer the call in as few rings as possible.



When you have an external telephone answering device (TAD) on your fax line, your TAD will determine the number of rings before the call is answered. Pay special attention to the directions in the Installation chapter for connecting a TAD to your fax machine.

## ECM (Error Correction Mode)

---

The Error Correction Mode (ECM) is a way for the fax machine to check the integrity of a fax transmission while it is in progress. ECM transmissions are possible only between machines that both have the ECM feature. If they do, you may send and receive fax messages that are continuously checked for their integrity.

Sufficient memory must be available in your machine for this feature to work.

# Glossary

- Anti Junk** Allows you to reject receiving the fax message or telephone call if you register a particular number with this function on.
- Automatic Document Feeder** Refers to the number of pages that can be placed in the document feeder and fed one at a time automatically.
- Automatic fax transmission** Sending a fax without picking up the handset or pressing **Speaker Phone** (for FAX-737MC only).
- Backup Print** Sets your machine to print a copy of faxes that are received and stored in memory.
- Beeper** The sound that the speaker makes when the keys are pressed, an error occurs or a document has been received or transmitted.
- Broadcasting** The ability to send the same fax message to more than one location.
- Call Back Message** Allows you to send a fax and then leave a message for the other party to call you back.
- Call Reservation** Allows you send a fax and then at the end of transmission, you can talk with the other party.
- Caller ID** A service purchased from the Telephone Company that lets you see the number (or name) of the party calling you.
- Cancel Job** Cancels a programmed job, for instance, Delayed Fax or Polling.
- CNG tones** The special tones (beeps) sent by fax machines during automatic transmission to tell the receiving machine that they are from fax machine.
- Communication error (or Comm. Error)** An error during fax sending or receiving, usually caused by line noise or static.
- Contrast** Setting to compensate for dark or light documents, by lightening dark documents or darkening light documents.
- Cover Page** Prints a page at the other party's machine, that contains the sender and recipient's name and fax number, number of pages and comment. You can generate an electronic cover page at the other end with pre-programmed information from memory or you can print a sample cover page to fax with your document.
- Delayed Transmission** Sends your fax at a later time that day.
- Distinctive Ringing** A service purchased from the Telephone Company that provides another phone number on an existing phone line. The fax machine uses the new number to simulate a dedicated fax line.
- ECM (Error Correction Mode)** Detects errors during fax transmission and resends the page(s) of the document that had an error.
- F/T Ring Time** The length of time the machine rings (when the answer mode setting is FAX/TEL) to notify you to pick up a voice call that it answered.
- Fax Forwarding** Sends a fax received in memory to another preprogrammed fax number.
- Fax tones** The signals sent by sending and receiving fax machines while communicating information.
- Fine Resolution** Resolution is 196 x 203 dpi. It is used for small print and graphs.

- Gray scale** The shades of grey available for copying and faxing photographs.
- Group number** A combination of One Touch and/or Speed Dial numbers that are stored on a One Touch Dial key for Broadcasting.
- ICM (Incoming Message)** A recorded voice message received into an external answering machine or FAX-737MC's digital Message Centre.
- Interrupt** Temporarily puts a waiting job on hold while you perform another operation.
- Journal** Lists information about the last 30 incoming and outgoing faxes.
- Journal Period** The preprogrammed time period between automatically printed Journal Reports. You can print Journal on demand without interrupting this cycle.
- LCD (Liquid Crystal Display)** The display screen on the machine that shows interactive messages during On-Screen Programming and defaults to the date and time when the machine is idle.
- Manual fax** When you press **Speaker Phone** (for FAX-737MC only)—**OR**—lift the handset so you can hear the receiving fax machine answer before you press **Fax Start** to begin transmission.
- Memory Status List** Shows how much memory is being used, how much is left, and the type of messages in memory.
- Memory usage** Instructs the machine how to allocate the memory.
- Message Centre (FAX-737MC only)** The Message Centre is an electronic messaging facility for faxes and voice mail. Callers can send you faxes or leave voice messages for you, and you can retrieve these from a remote location.
- Next Fax Reservation** Accepts the next document in the document feeder for transmission while the machine is still receiving.
- OGM (Outgoing Message)** The message which callers can hear when you call your Message Centre or external answering machine.
- Out of Paper Reception** Receives faxes into the machine's memory when the machine is out of paper.
- Overseas Mode** Makes temporary changes to the fax tones to accommodate noise and static on overseas phone lines.
- Paging (FAX-737MC only)** Feature enables your fax unit to call your pager when a fax and/or a voice message is received into its memory.
- Pause** Allows you to place a 3.5 second delay in the dialling sequence stored on One Touch and Speed Dial numbers.
- PBX (Private Branch Exchange)** This machine can be connected to PBX. With connecting PBX you can transfer a call to another extension by pressing **Recall**.
- Photo Resolution** A resolution setting that uses varying shades of grey for the best representation of photographs.
- Polling** The process of a fax machine calling another fax machine to retrieve waiting fax messages.
- Print reduction** reduces the size of incoming faxes.
- Pulse** A form of dialling on a telephone line.
- Quick-Dial** Keys on the machine control panel where you can store numbers for easy dialling. You must use a separate key for each number.

- Quick-Dial List** A listing of names and numbers stored in One Touch and Speed Dial memory, in numerical order.
- Remote access** The ability to access your messages stored in the machine's memory remotely from a touch tone phone.
- Remote access code** The four-digit code that allows you to call and access your messages stored in the machine's memory from a remote location.
- Remote activation** allows you to transfer a fax call, answered at an extension phone, to the machine by pressing the Fax Receive Code.
- Resolution** The number of vertical and horizontal lines per mm. See: Standard, Fine, Super Fine and Photo resolution.
- Ring Delay** The number of telephone rings before the machine answers a call in F/T or FAX ONLY mode.
- Scanning** The process of sending an electronic image of an original paper document into your computer.
- Standard resolution** 98 x 203 dpi. It is used for regular size text and quickest transmission.
- Station ID** The stored information that appears on the top of faxed pages. It includes the sender's name and fax number.
- Super fine resolution** 392 x 203 dpi. Best for very small print and line art.
- System Setup List** A printed report that shows the current setting of your machine.
- Thermal transfer** A printing process in which heat transfers carbon ink from a ribbon to plain paper.
- Toll Saver (FAX-737MC only)** A Message Centre setting that allows the machine to answer after two ring when a message(s) was received and after four rings when there are no messages. The caller can hang up (after two rings) without paying for the call if there are no messages to retrieve.
- Tone** A form of dialling on the telephone line used for Touch Tone telephones.
- Transmission** The process of sending documents over the phone lines from your fax machine to the receiving fax machine.
- Transmission Report** A listing of each transmission, showing name and number, date, time, and number of pages.
- TX/RX** TX means Transmit. RX means Receive.

# Index

- A**
- Alternating Displays ..... ii
  - Answer Mode ..... 5, 23, 24
  - Automatic Document Feeder ..... 2
- B**
- Backup Printing ..... 68
  - Beeper ..... 14
  - Broadcasting ..... 19, 22
- C**
- Call Back Message ..... 38
  - Call Reservation ..... 38
  - Cancelling a Job ..... 58
  - Cleaning ..... 83, 84
  - Connecting ..... 4, 5, 7
  - Contrast ..... 20
  - Control Panel ..... 8–11
  - Copy ..... 28
  - Copy (Multiple) ..... 28
  - Corrections ..... 106
  - Cover Page ..... 35–37
- D**
- Date and Time ..... 12
  - Delayed Polling ..... 57
  - Delayed Transmission ..... 39
  - Dialling a Number ..... 21
  - Dialling Mode ..... 12
  - Distinctive Ringing (Duet) ..... 47
  - Document ..... 2
  - Document Size ..... 2
- E**
- ECM (Error Correction Mode) ..... 107
  - Entering Text ..... 106
  - Erasing Messages ..... 67, 69
  - Error Messages ..... 77
  - Extension Telephone ..... 25, 44
  - External Telephone ..... 7, 44
  - External Telephone Answering Device (TAD) ..... 5
- F**
- F/T (Fax/Tel) Mode ..... 23, 32, 44
  - F/T (Fax/Tel) Outgoing Announcement (OGM) ..... 25
  - F/T (Fax/Tel) Ring Time ..... 25
  - F/T Pseudo-Ringing ..... 25
  - Fax Detect ..... 26
  - Fax Forwarding ..... 70
  - Fax Journal ..... 34
  - Fax Only Mode ..... 23
  - Fax Receive Code ..... 6, 26, 44, 46
  - Fax Redial ..... 22
  - Fax Storage ..... 60
  - Fax Tones and Handshake ..... 107
  - Fine Resolution ..... 20
  - Flexible Memory Settings ..... 65
  - Function Mode ..... ii
  - Function Selection Table ..... 100–105
- G**
- Grey Scale ..... 98
  - Groups ..... 19
- H**
- HELP ..... 34
  - Help ..... i
  - Hold ..... 8, 10, 16, 32



<b>I</b>	
ICM Recording Monitor .....	70
Important Safety Instructions .....	91
Inserting Spaces .....	106
Interrupting .....	40

<b>J</b>	
Jams .....	79
Journal Period .....	33

<b>M</b>	
Maintenance .....	83
Manual Mode .....	23
Manual Transmission .....	20
Maximum Message Time .....	69
Melody .....	16
Melody Alarm .....	16
Memory .....	27, 65
Memory Security .....	40
Memory Status List .....	34
Memory Storage .....	4
Memory Transmission .....	37
Menu Mode .....	100
Menu Selection Table .....	100
Message Centre Mode .....	65
Message Store .....	65
MSG CTR OGM .....	66
Multiple Resolution .....	43
Mute .....	32

<b>N</b>	
Navigation Keys .....	9, 10
Next-Fax Reservation .....	39

<b>O</b>	
OGM (Outgoing Message) .....	66, 71
One Touch Dialing .....	17, 21

On-Screen Programming .....	ii
Operation from an External or Extension Telephone .....	44
Overseas Mode .....	37

<b>P</b>	
PABX .....	15
Paging .....	70
Pause .....	31
Photo Resolution .....	20
Playing Messages .....	68
Polling .....	56
Power .....	4
Printing .....	27, 33, 36
Program Fax Forward Number .....	60, 71

<b>Q</b>	
Quick-Dial List .....	34

<b>R</b>	
Recording a Conversation .....	70
Recording Monitor .....	70
Redial .....	22
Reduction .....	26
Remote Access Code .....	61, 72
Remote Code .....	46
Remote Commands .....	62, 73
Remote Retrieval .....	61, 72
Reports .....	34
Resolution .....	20
Ring Delay .....	24
Ring Pattern .....	16
Ring Volume .....	14

<b>S</b>	
Safety Instructions .....	91
scroll .....	ii

Search .....	21, 31
Sequential Polling .....	57
Setting Up .....	1
Speaker Volume .....	14
Speakerphone .....	32
Special Characters .....	106
Specification .....	98
Speed Dialing .....	18, 21
Standard Resolution .....	20
Station ID .....	13
Super Fine Resolution .....	20

## T

TAD Mode .....	23
Telephone Answer Code .....	44, 46
Telephone Answering Device (TAD) .....	5
Temporary Cover Page .....	35
Toll Saver .....	70
Tone/Pulse .....	12
Transmission Verification Report .....	33
Troubleshooting .....	77

## U

User Settings List .....	34
--------------------------	----

## V

Voice Calls .....	30
Volume .....	14

# Accessory List

Model Name	Description
PC-401	Printing Cartridge and a re-fill (1 set per box)
PC-402RF	2 re-fills for use in PC-401 Printing Cartridge
PC-404RF	4 re-fills for use in PC-401 Printing Cartridge
PC-AS4RF	4 re-fills for use in PC-401 Printing Cartridge (Not available in Australia and New Zealand)

**\*For optimum print quality and product performance within published specifications, use only the correct Brother replacement ribbon. Failure to use the genuine Brother consumable may damage the machine and such damages will not be covered under warranty.**

(For FAX-717/727) →

**Change Answer Mode**  
Press **9 8**.  
then for **TAD**, press **1**.  
**Fax/Telephone (F/T)**, press **2**.  
**Fax**, press **3**.

**Exit Remote Operation**  
Press **9 0**.

**Change Remote Access Code**

- 1 Press **Menu/Set**, **8**, **3**.
- 2 Enter a three- digit number. The \* cannot be changed.
- 3 Press **Menu/Set**.
- 4 Press **Stop/Exit**.

**REMOTE CONTROL ACCESS CARD**

**Using Remote Access Code**

- 1 Dial your machine phone number from a touch tone phone.
- 2 Enter your Remote Control Access Code (3 digits followed by \*) after the beep.
- 3 Your machine signals the kinds of messages received:  
**1 long beeps – Fax message(s)**  
**No beeps – no messages**
- 4 After 2 short beeps, enter a command.
- 5 Press **9 0** to reset your machine when you finish.
- 6 Hang up.

(For FAX-737MC) ↓

**Retrieve a Fax**  
Press **9 6**.  
then to **Print a Memory Status List** press **1**, then enter the number of remote fax machine, and then **# #**. After the beep, hang up and wait.  
**Retrieve all faxes** press **2**, then enter the number of remote fax machine, and then **# #**. After the beep, hang up and wait.  
**Erase all fax messages** press **3**.

**Check Receiving Status**  
Press **9 7**.  
then for **Fax message**, press **1**.  
**Voice message**, press **2**.  
**1 long beeps – received messages**  
**3 short beeps – no messages**

**Change Answer Mode**

Press **9 8**.  
then for **Message Centre**, press **1**.  
**Fax/Telephone (F/T)**, press **2**.  
**Fax Only**, press **3**.

**Exit Remote Operation**  
Press **9 0**.

**MESSAGE MANAGER**

**REMOTE CONTROL ACCESS CARD**

**Using Remote Access Code**

- 1 Dial your fax machine phone number from a touch tone phone.
- 2 Enter your Remote Control Access Code (3 digits followed by \*) after the beep.
- 3 The fax machine signals the kinds of messages received:  
**1 long beep – Fax message(s)**  
**2 long beeps – Voice message(s)**  
**3 long beeps – Fax and Voice message(s)**  
**No beeps – no messages**
- 4 After 2 short beeps, enter a command.
- 5 Press **9 0** to reset the machine when you finish.
- 6 Hang up.

## Remote Commands

### Change Fax Forwarding Setting

Press **9 5**.

*then to* **Turn feature off** press **1**.

**Enter Fax Forwarding** press **2**.

**Program Fax Forward Number** press **4**. Enter the new number of the remote fax machine where you want your fax messages forwarded, and then press **##**. Press **9 6 1** after two short beeps, then enter the number of remote fax machine, and then **##** to retrieve Memory Status List.

**Turn Fax Storage on** press **6**.

**Turn Fax Storage off** press **7**.

②

### Retrieve a Fax

Press **9 6**.

*then to* **Print a Memory Status List** press **1**, then enter the number of remote fax machine, and then **##**. After the beep, hang up and wait.

**Retrieve all faxes** press **2**, then enter the number of remote fax machine, and then **##**. After the beep, hang up and wait.

**Erase all fax messages** press **3**.

### Check the Receiving Status

Press **9 7 1**.

**1 long beep – Fax message(s)**

**3 short beeps – no messages**

③

## Changing Remote Access Code

- 1 Press **Menu/Set**, **8**, **7**.
- 2 Enter a three-digit code using number keys 0-9. The \* cannot be changed.
- 3 Press **Menu/Set**.
- 4 Press **Stop/Exit**.

## Remote Commands

### Listen to Voice Messages

Press **9 1**.

*then to* **Repeat a message** press **1**.

**Skip to next message**, press **2**.

**Stop playing the message** press **9**.

②

## Erase All Voice Messages

Press **9 3**. If you hear three beeps, all messages have not yet been heard, and the messages will not be erased.

## Play/Record Outgoing Message

Press **9 4**.

*then to* **Play Message Centre OGM** press **1 1**.

**Play F/T OGM** press **1 2**.

**Play Paging OGM** press **1 3**.

**Record new Message Centre OGM**

press **2 1**, then speak after beep.

press **9** to stop.

**Record new F/T OGM** press **2 2**.

then speak after beep. press **9** to stop.

**Record new Paging OGM** press **2 3**.

then speak after beep. press **9** to stop.

③

## Change Paging/Fax Forwarding Setting

Press **9 5**.

*then to* **Turn feature off** press **1**.

**Enter Fax Forwarding** press **2**.

**Enter Paging** press **3**.

**Program Fax Forward Number**

press **4**. Enter the new number of

the remote fax machine where

you want your fax messages

forwarded, and then press **##**.

Press **9 6 1** after two short beeps,

then enter the number of remote

fax machine, and then **##** to

retrieve Memory Status List.

④

**brother**®

This machine is approved for use in the country of purchase only, local Brother companies or their dealers will only support fax machines purchased in their own countries.

ARL/ASA/NZ  
Version A