

At your side.
brother®

USER'S GUIDE

FAX-1840C

MFC-3240C



At your side.
brother®

If you need to call Customer Service

Please complete the following information for future reference:

Model Number: FAX-1840C and MFC-3240C
(Circle your model number)

Serial Number:* _____

Date of Purchase: _____

Place of Purchase: _____

*** The serial number is on the back of the unit. Retain this User's Guide with your sales receipt as a permanent record of your purchase, in the event of theft, fire or warranty service.**

Register your product on-line at

<http://www.brother.com/registration>

By registering your product with Brother, you will be recorded as the original owner of the product.

THIS EQUIPMENT IS DESIGNED TO WORK WITH A TWO WIRE ANALOGUE PSTN LINE FITTED WITH THE APPROPRIATE CONNECTOR.

APPROVAL INFORMATION

Brother advises that this product may not function correctly in a country other than where it was originally purchased, and does not offer any warranty in the event that this product is used on public telecommunication lines in another country.

Compilation and Publication Notice

Under the supervision of Brother Industries Ltd., this manual has been compiled and published, covering the latest product descriptions and specifications.

The contents of this manual and the specifications of this product are subject to change without notice.







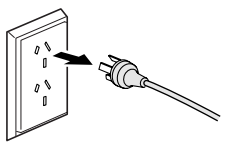

Brother reserves the right to make changes without notice in the specifications and materials contained herein and shall not be responsible for any damages (including consequential) caused by reliance on the materials presented, including but not limited to typographical and other errors relating to the publication.

Safety precautions

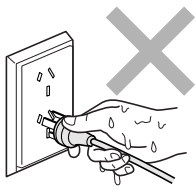
To use the machine safely

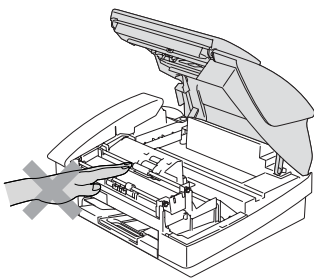
Please refer to these instructions for later reference and before attempting any maintenance.

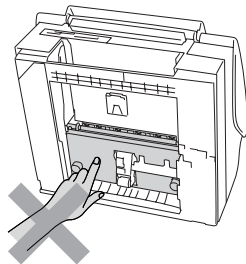
WARNING

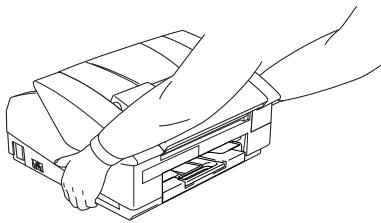
	<p>There are high voltage electrodes inside the machine. Before you clean the machine, make sure you have unplugged the telephone line cord first and then the power cord from the electrical socket.</p> 		<p>Do not handle the plug with wet hands. Doing this might cause an electrical shock.</p> 
	<p>To prevent injuries, be careful not to touch the area shaded in the illustration.</p> 		<p>When you move the machine, grasp the side handholds as shown in the illustration.</p> 
	<p>When you move the machine, place a hand at each side of the unit so you are supporting the base when you lift it. (See the illustration on the right.)</p> 		

- Use caution when installing or modifying telephone lines. Never touch telephone wires or terminals that are not insulated unless the telephone line has been disconnected at the wall socket. Never install telephone wiring during a lightning storm. Never install a telephone wall socket in a wet location.
- This product must be installed near an electrical socket that is easily accessible. In case of emergencies, you must disconnect the power cord from the electrical socket in order to shut off power completely.

IMPORTANT SAFETY INSTRUCTIONS

When using your telephone equipment, basic safety precautions should always be followed to reduce the risk of fire, electric shock and injury to persons, including the following:



1. Do not use this product near water, for example, near a bath tub, wash bowl, kitchen sink or washing machine, in a wet basement or near a swimming pool.
2. Avoid using this product during an electrical storm. There may be a remote risk of electric shock from lightning.
3. Do not use this product to report a gas leak in the vicinity of the leak.

SAVE THESE INSTRUCTIONS

Choosing a location

Place your machine on a flat, stable surface that is free of vibration and shocks, such as a desk. Put the machine near a telephone socket and a standard, grounded electrical socket. Choose a location where the temperature remains between 10°-35°C.

! Caution

- Avoid placing your machine in a high-traffic area.
- Avoid placing your machine on the carpet.
- Do not place near heaters, air conditioners, water, chemicals, or refrigerators.
- Do not expose the machine to direct sunlight, excessive heat, moisture, or dust.
- Do not connect your machine to electrical sockets controlled by wall switches or automatic timers.
- Disruption of power can wipe out information in the machine's memory.
- Do not connect your machine to electrical sockets on the same circuit as large appliances or other equipment that might disrupt the power supply.
- Avoid interference sources, such as speakers or the base units of cordless phones.

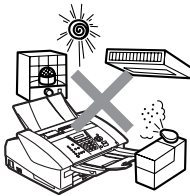

Quick Reference Guide

Sending faxes

Automatic Transmission

- 1 If it is not illuminated in green, press  (**Fax**).
- 2 Load your document.
- 3 Enter the fax number using One-Touch, Speed-Dial, Search or the dial pad.
- 4 Press **Mono Start** or **Colour Start**.

Storing numbers

Storing One-Touch Dial numbers

- 1 Press **Menu/Set, 2, 3, 1**.
- 2 Press the One-Touch key where you want to store the number.



To access a One-Touch number that is shown in a black square on the control panel, hold down **Shift** as you press the One-Touch key.

- 3 Enter a number (up to 20 digits), and then press **Menu/Set**.
- 4 Enter a name up to 15 characters (or leave it blank), and then press **Menu/Set**.
- 5 Press **Stop/Exit**.

Storing Speed-Dial numbers

- 1 Press **Menu/Set, 2, 3, 2**.
- 2 Using the dial pad, enter a two-digit Speed-Dial location number, and then press **Menu/Set**.
- 3 Enter a number (up to 20 digits), and then press **Menu/Set**.
- 4 Enter a name up to 15 characters (or leave it blank), and then press **Menu/Set**.
- 5 Press **Stop/Exit**.

Dialling operations

One-Touch Dialling/ Speed-Dialling

- 1 If it is not illuminated in green, press  (**Fax**).
- 2 Load your document.
- 3 Press the One-Touch key of the number you want to call.



To dial a One-Touch number that is shown in a black square on the control panel, hold down **Shift** as you press the One-Touch key.

—OR—

Press **Search/Speed Dial**, press #, and then press the two-digit Speed-Dial number.

- 4 Press **Mono Start** or **Colour Start**.

Using Search

- 1 If it is not illuminated in green, press  (**Fax**).
- 2 Load your document.
- 3 Press **Search/Speed Dial**, and then enter the first letter of the name you're looking for.
- 4 Press ◀ or ▶ to search the memory.
- 5 Press **Mono Start** or **Colour Start**.

Making copies

- 1 Press  (**Copy**) to illuminate it in green.
- 2 Load your document.
- 3 Press **Mono Start** or **Colour Start**.

Table of Contents

1

Introduction	1-1
Using this Guide	1-1
Finding information	1-1
Symbols used in this Guide	1-1
Control panel overview	1-2
Turning the machine to Power Save condition	1-5
Power Save Setting	1-6
Load documents	1-7
Using the automatic document feeder (ADF)	1-7
Recommended environment	1-7
About paper	1-9
Recommended Paper	1-9
Handling and using special paper	1-10
Paper type and size for each operation	1-11
Paper weight, thickness and capacity	1-12
Paper capacity of the output paper tray	1-12
Printable area	1-13
How to load paper, envelopes and post cards	1-14
To load paper or other media	1-14
To load envelopes	1-16
To load post cards	1-17
About fax machines	1-18
Fax tones and handshake	1-18
ECM (Error Correction Mode)	1-19

2

Getting started	2-1
Initial Setup	2-1
Setting the Date and Time	2-1
Setting Tone or Pulse dialling mode (Not available in New Zealand)	2-1
Setting the Station ID	2-2
Setting the Phone Line Type	2-3
PABX and TRANSFER	2-3
General Setup	2-4
Setting the Mode Timer (MFC-3240C only)	2-4
Setting the Mode Timer (FAX-1840C only)	2-5
Setting the Paper Type	2-6
Setting the Paper Size	2-6
Setting the Ring Volume	2-7
Setting the Beeper Volume	2-7

Setting the Speaker Volume	2-8
Turning on Automatic Daylight Savings Time	2-8
Setting the LCD Contrast	2-8

3

Setup Send	3-1
How to enter Fax mode	3-1
How to dial	3-1
Manual dialling	3-1
One-Touch dialling	3-2
Speed-Dialling	3-2
Search	3-3
Fax Redial	3-3
How to Fax (B&W and Colour)	3-4
Colour fax transmission	3-4
Faxing from the ADF	3-4
Automatic transmission	3-4
Manual transmission	3-5
Sending a fax at the end of a conversation	3-5
Basic sending operations	3-6
Sending faxes using multiple settings	3-6
Contrast	3-6
Fax Resolution	3-7
Dual Access (Not available for colour faxes)	3-8
Real Time Transmission	3-9
Checking job status	3-10
Cancelling a fax in progress	3-10
Cancelling a scheduled job	3-10
Advanced sending operations	3-11
Broadcasting (Not available for colour faxes)	3-11
Overseas Mode	3-12
Delayed Fax (Not available for colour faxes)	3-13
Delayed Batch Transmission (Not available for colour faxes)	3-14
Setup for Polled Transmit (Standard) (Not available for colour faxes)	3-15
Setup for Polled Transmit with Secure Code (Not available for colour faxes)	3-16
TX Lock (Key Lock for some countries)	3-17
Setting up the password	3-18
Changing the TX Lock password	3-18
Turning TX Lock on	3-19
Turning TX Lock off	3-19

4

Setup Receive	4-1
Basic receiving operations.....	4-1
Choosing the Receive Mode	4-1
To select or change your Receive Mode	4-2
Setting the Ring Delay	4-2
Setting the F/T Ring Time (Fax/Tel mode only).....	4-3
Fax Detect (MFC-3240C only).....	4-4
Fax Detect (FAX-1840C only)	4-5
Printing a reduced incoming fax (Auto Reduction)	4-6
Receiving a fax at the end of a conversation.....	4-6
Printing a fax from the memory	4-7
Reception into memory (Not available for colour fax reception).....	4-7
Polling.....	4-8
Secure Polling	4-8
Setup for Polling Receive (Standard)	4-8
Setup for Polling Receive with Secure Code.....	4-9
Setup Delayed Polling Receive	4-9
Sequential Polling.....	4-10

5

Quick-Dial numbers and dialling options	5-1
Storing numbers for easy dialling	5-1
Storing One-Touch Dial numbers	5-1
Storing Speed-Dial numbers	5-2
Changing One-Touch and Speed-Dial numbers	5-3
Setting up Groups for Broadcasting	5-4
Dialling options	5-6
Access codes and credit card numbers.....	5-6
Pause	5-6
Tone or Pulse (Not available in New Zealand).....	5-7
Telephone (voice) operation (FAX-1840C only)	5-8
How to dial.....	5-8
Making a telephone call.....	5-8
Tel.....	5-8
Mute (FAX-1840C only).....	5-8

6

Remote Fax Options (Not available for colour faxes)	6-1
Setting up Fax Forwarding	6-1
Setting Fax Storage.....	6-2
Turning off Remote Fax Options	6-2
Setting your Remote Access Code.....	6-3

Remote Retrieval	6-4
Using your Remote Access Code	6-4
Remote commands	6-5
Retrieving fax messages	6-6
Changing your Fax Forwarding number	6-6

7

Printing reports	7-1
Fax settings and activity	7-1
Customizing the Transmission Verification Report	7-1
Setting the Journal Period	7-2
Printing reports	7-3
How to print a report	7-3

8

Making copies	8-1
Using the machine as a copier	8-1
Enter Copy mode	8-1
Making a single copy	8-2
Making multiple copies	8-2
Stop copying	8-2
Using the temporary Copy keys	
(Temporary settings)	8-3
Increasing copy speed or quality	8-4
Changing the temporary copy settings	8-5
Enlarging or reducing the image copied	8-6
Setting paper type	8-8
Setting paper size	8-8
Adjusting brightness	8-9
Adjusting contrast	8-9
Making N in 1 copies or a poster (Page Layout) ...	8-10
Changing the default copy settings	8-12
Increasing copy speed or quality	8-12
Adjusting brightness	8-12
Adjusting contrast	8-13
Adjusting colour saturation	8-13
Legal limitations	8-14

9

Important information	9-1
Important Information for Australia	9-1
IMPORTANT-For Your Safety	9-1
Disconnect device	9-1
International ENERGY STAR®	
Compliance Statement	9-2
Important safety instructions	9-2

Important Information for New Zealand	9-4
Important Safety Instructions	9-4
IMPORTANT-For Your Safety	9-7
Disconnect device	9-7
IMPORTANT NOTICE	9-7
Important Information for Some Countries	9-8
Important Safety Instructions	9-8
Trademarks	9-11

10

Troubleshooting and routine maintenance	10-1
Troubleshooting	10-1
Error messages	10-1
Document Jam	10-4
Document is jammed inside the front of the machine	10-4
Printer jam or paper jam	10-5
Paper is jammed inside the paper tray	10-5
Paper is jammed inside the machine	10-6
If you are having difficulty with your machine	10-8
Compatibility	10-12
How to improve print quality	10-13
Cleaning the print head	10-13
Checking the print quality	10-14
Checking the printing alignment	10-16
Checking the ink volume	10-17
Packing and shipping the machine	10-18
Routine maintenance	10-21
Cleaning the Scanner	10-21
Cleaning the machine Printer Platen	10-22
Replacing the ink cartridges	10-23

A

Appendix A	A-1
Telephone Service for Australia	A-1
Telstra® FaxStream® Duet® (Distinctive Ringing)	A-1
What is the Advantage of using Telstra®	
FaxStream® Duet® Function?	A-1
How does Telstra® FaxStream® Duet® Work?	A-2
Set the Distinctive Ringing to ON	A-3
Caller ID (Caller IDentification)	A-3
Advantages of Caller ID	A-3
How Does the Caller ID Work?	A-4
The Caller ID Appears on the Display When Your Telephone Rings	A-4
The Caller ID is Stored in Your MFC Memory	A-4

Viewing Caller ID List.....	A-5
Printing Caller ID List.....	A-5
Telephone Service for New Zealand	A-6
FaxAbility	A-6
How Will the Fax Machine Treat All Other Numbers?	A-6
What is the Advantage of Using the FaxAbility Function?.....	A-6
How Does FaxAbility Work?	A-7
How to Turn FaxAbility OFF or ON.....	A-8
Caller ID (Caller IDentification)	A-9
Advantages of Caller ID.....	A-9
How Does the Caller ID Work?	A-9
The Caller ID Appears on the Display When Your Telephone Rings	A-9
Viewing Caller ID List.....	A-10
Printing Caller ID List.....	A-10
Telephone Service for Some Countries.....	A-11
Distinctive Ringing (For Singapore and Hong Kong)	A-11
Setting the Distinctive Ringing.....	A-11
Caller ID (For Singapore and Hong Kong).....	A-12
Viewing Caller ID List.....	A-13
Printing Caller ID List.....	A-13
Advanced receiving operations.....	A-14
Operation from extension telephones.....	A-14
Fax/Tel mode.....	A-15
Fax/Tel mode in the Power Save condition	A-15
Using a cordless external handset.....	A-16
Changing the remote codes.....	A-16
Connecting an external device to your machine.....	A-17
Connecting an external telephone	A-17
Connecting an external telephone answering device (TAD)	A-18
Sequence	A-18
Connections.....	A-19
Recording outgoing message (OGM) on an external TAD.....	A-20
Multi-line connections (PBX) (For Australia and New Zealand only)	A-21
If you are installing the machine to work with a PBX	A-21
Custom features on your phone line.....	A-21

B

Appendix B	B-1
On-screen programming.....	B-1
Menu table.....	B-1
Memory storage.....	B-1
Navigation keys	B-2
Entering Text	B-9
Inserting spaces	B-9
Making corrections	B-9
Repeating letters	B-9
Special characters and symbols.....	B-10

G

Glossary	G-1
-----------------------	------------

S

Specifications	S-1
Product description	S-1
General	S-1
Print media	S-3
Copy	S-3
Fax.....	S-4
Scanner (MFC-3240C only).....	S-5
Printer	S-6
Interfaces.....	S-7
Computer requirements	S-7
Consumable items.....	S-8
Optional External Wireless Print/Scan Server (NC-2200w) (MFC-3240C only).....	S-9
 Index	 I-1
 Remote Retrieval Access card	 R-1

1 Introduction

Using this Guide

Thank you for buying a Brother fax machine or Multi-Function Center (MFC). Your machine is simple to use, with LCD screen instructions to guide you through programming it. You can make the most of your machine by reading through this Guide.





Finding information

All the chapter headings and subheadings are listed in the Table of Contents. You will be able to find information about a specific feature or operation by checking the Index at the back of this Guide.

Symbols used in this Guide

Throughout this Guide you will see special symbols alerting you to important warnings, notes and actions. To make things clearer and to help you press the correct keys, we used special fonts and added some of the messages that will appear in the LCD.

- | | |
|----------------|---|
| Bold | Bold typeface identifies specific keys on the machine control panel. |
| <i>Italics</i> | Italicized typeface emphasizes an important point or refers you to a related topic. |
| Courier New | Courier New type face identifies the messages on the LCD of the machine. |

-  Warnings inform you what to do to avoid possible personal injury.
-  Cautions specify procedures you must follow or avoid to prevent possible damage to the machine.
-  Notes tell you how you should respond to a situation that may arise or give tips about how the current operation works with other features.
-  Improper Setup alerts you to devices and operations that are not compatible with the machine.

Control panel overview

MFC-3240C

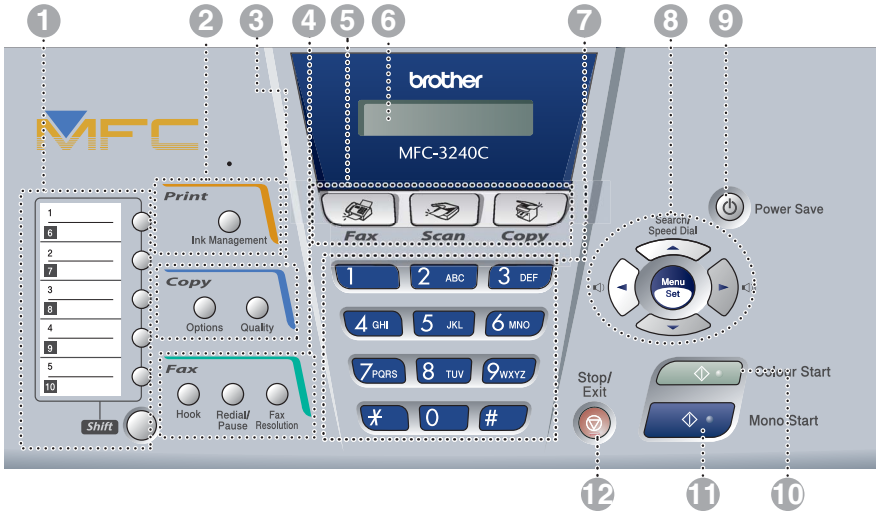

FAX-1840C

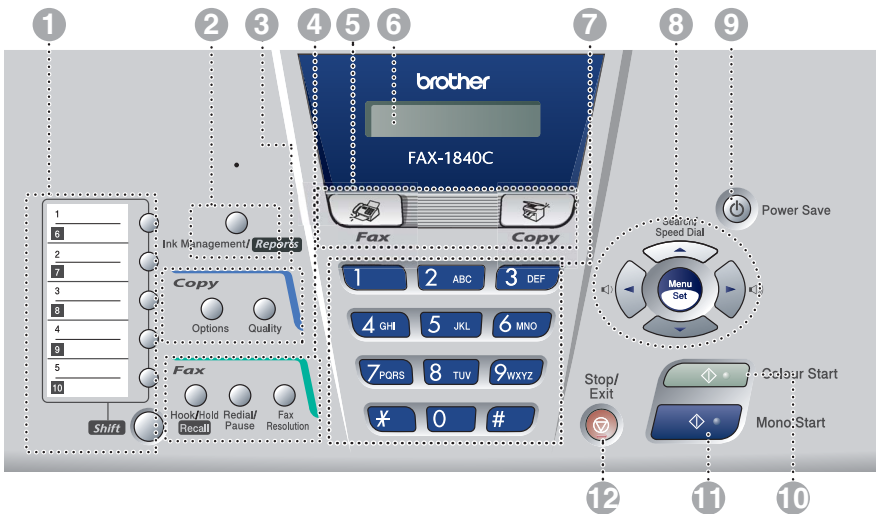

1 One-Touch keys

These keys give you instant access to previously stored Quick-Dial numbers.

Shift

To access a One-Touch number in a black square on the control panel, hold down this key as you press the One-Touch key.

2 Ink Management (MFC-3240C only)

Lets you clean the print head, check the print quality, and check the available ink volume.

Ink Management/Reports (FAX-1840C only)

Lets you clean the print head, check the print quality, and check the available ink volume.

—OR—

Lets you access the Reports menu if pressed while holding it down with the **Shift** key.

3 Copy keys

Options

You can quickly and easily select temporary settings for copying.

Quality

Use this key for temporary copy settings.

4 Fax and telephone keys

Hook (MFC-3240C only)

Press before dialling if you want to make sure a fax machine will answer, and then press **Mono Start** or **Colour Start**.

Hook/Hold/Recall (FAX-1840C only)

Use to swap the line between handset and monitor speaker.

—OR—

Lets you place calls on hold.

—OR—

Also, use this key pressing with **Shift** key to gain access to an outside line and/or to recall the operator or transfer a call to another extension when it is connected to a PABX.

Redial/Pause

Redials the last number you called. It also inserts a pause in quick-dial numbers.

Fax Resolution

Adjusts the resolution when you send a fax.

5 Mode keys:



Fax

Lets you access Fax mode.



Scan

(MFC-3240C only)

Lets you access Scan mode.



Copy

Lets you access Copy mode.

6 Liquid Crystal Display (LCD)

Displays messages on the screen to help you set up and use your machine.

7 Dial Pad

Use these keys to dial telephone and fax numbers and as a keyboard for entering information into the machine.

The # key lets you temporarily switch the dialling mode during a telephone call from Pulse to Tone. (Not available in New Zealand)

8 Navigation keys:

Menu/Set

The same key is used for Menu and Set operations. Lets you access the Menu to program and store your settings in the machine.



You can press these keys to adjust the volume.

▲ Search/Speed Dial

Lets you look up numbers that are stored in the dialling memory. It also lets you dial stored numbers by pressing # and a two-digit number.

◀ Press to scroll backward to a menu selection.

▲ or ▼

Press to scroll through the menus and options.

9 Power Save

You can turn the machine to power save condition.

10  Colour Start

Lets you start sending faxes or make copies in full colour.

Also for MFC-3240C, lets you start a scanning operation (in colour or mono, depending on the scanning setting on your PC).

11  Mono Start

Lets you start sending faxes or make copies in black and white.

Also for MFC-3240C, lets you start a scanning operation (in colour or mono, depending on the scanning setting on your PC).

12  Stop/Exit

Stops an operation or exits from the menu.

Turning the machine to Power Save condition

When the machine is idle, you can turn it to Power Save condition by pressing the Power Save key. In Power Save mode, the machine will receive telephone calls as normal. For further information on receiving faxes in the power save condition, please see the table on page 1-6. You can also receive faxes in F/T mode if your machine is fitted with a handset (See *Power Save Setting* on page 1-6.) The delayed faxes that have been set up will be sent. You can even retrieve faxes using Remote Retrieval if you are away from your machine. If you want to do other operations, you must turn the machine back on.

Turning the machine to Power Save condition

Press and hold down the **Power Save** key until the LCD shows:

Shutting Down

The LCD light will go off.

Turning the machine to Power Save condition off

Press and hold down the **Power Save** key until the LCD shows:

Please Wait

The LCD will show the date and time (Fax mode).



Even if you have turned the machine off, it will periodically clean the print head to preserve print quality.

If you unplug the AC power cord, no machine operations will be available.



You can turn the machine Off by customizing the **Power Save** key as shown next page. In this Off mode, no machine operation will be available. (See *Power Save Setting* on page 1-6.)



The external telephone is always available.

Power Save Setting

You can customise the machine's **Power Save** key. The default mode is `Fax Receive:On`, so your machine can receive faxes or calls even when the machine is in Power Save mode. If you do not want your machine to receive faxes or calls, turn this setting to `Fax Receive:Off`. (See *Turning the machine to Power Save condition* on page 1-5.)

1 Press **Menu/Set, 1, 6**.

6.P.Save Setting

2 Press **▲** or **▼** to select `Off` (or `On`).

3 Press **Menu/Set**.

4 Press **Stop/Exit**.

On/Off Setting	Receive Mode	Available Operations
Fax Receive:On (default)	Fax Only External TAD	Fax Receive (automatically), Fax Detect, Delayed Fax* ¹ , Remote Fax Options* ¹ , Remote Retrieval* ¹ : ■ (FAX-1840C only) You can receive telephone calls by lifting the handset.
	Manual Fax/Tel* ²	Delayed Fax* ¹ , Fax Detect: ■ (FAX-1840C only) You can receive telephone calls by lifting the handset.
Fax Receive:Off	—	No machine operations will be available.

*¹ Should be set before you switch off the machine.

*² You can not receive a fax automatically even if you have set the receive mode to `Fax/Tel`. (MFC-3240C only)

Load documents

You can send a fax, make copies, and scan from the ADF (automatic document feeder).

Using the automatic document feeder (ADF)

The ADF can hold up to 20 pages and feeds each sheet individually. Use standard 80 gsm paper and always fan the pages before putting them in the ADF.

Recommended environment

Temperature: 20° - 30° C

Humidity: 50% - 70%

Paper: 80 gsm A4

 DO NOT use paper that is curled, wrinkled, folded, ripped, stapled, paper clipped, pasted or taped.

DO NOT use cardboard, newspaper or fabric.

■ Make sure documents written with ink are completely dry.

■ Documents to be faxed must be from 8.9 to 21.6 cm wide and 12.7 to 35.6 cm long.

- 1 Fan the pages well.
- 2 Open the document tray (1) and pull out the extension (2) and then open the document support (3).

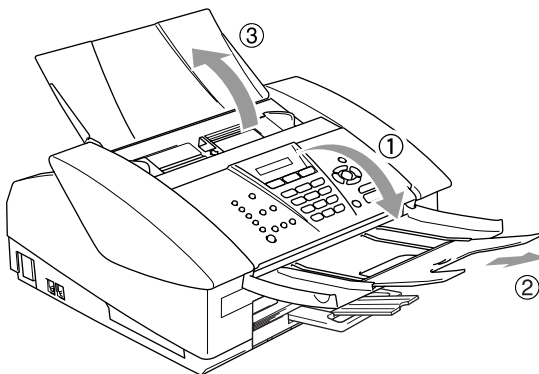

- 3 Put the documents **face down, top edge first** in the ADF until you feel them touch the feed roller (4).
- 4 Adjust the paper guides to fit the width of your documents (5).

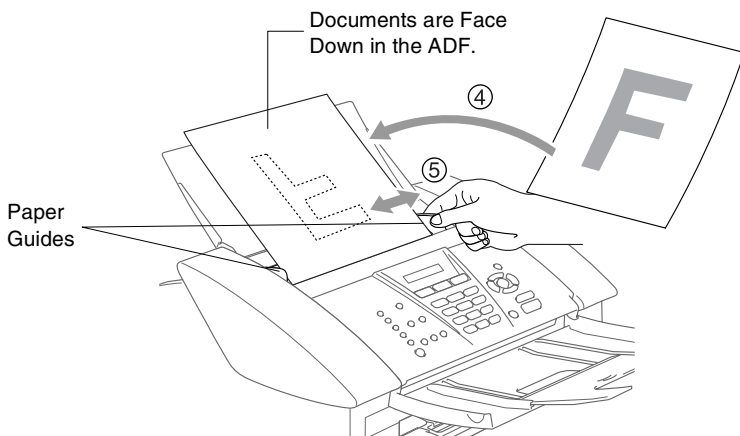

! **DO NOT** pull on the document while it is feeding.

About paper

The print quality can be affected by the type of paper you use in the machine.

To get the best print quality for the settings you've chosen, always set the Paper Type to match the type of paper you load.

You can use plain paper, inkjet paper (coated paper), glossy paper, transparencies and envelopes.

We recommend testing various paper types before purchasing large quantities.

For best results, use the recommended paper.



- When you print on inkjet paper (coated paper), transparencies and glossy paper, be sure to select the proper media in the “Basic” tab of the printer driver or in the Paper Type setting of the menu (**Menu/Set, 1, 2**).
- When you print on Brother glossy paper, load the instruction sheet included with the glossy paper in the paper tray first, and then place the glossy paper on the instruction sheet.
- When you use transparencies or glossy paper, remove each sheet immediately to prevent smudging or paper jams.
- Avoid touching the printed surface of the paper immediately after printing; the surface may not be completely dry and may stain your fingers.

Recommended Paper

To get the best print quality, we suggest using Brother paper. (See table below.)

If Brother paper is not available in your country, we recommend testing various papers before purchasing large quantities.

We recommend using “3M Transparency Film” when you print on transparencies.

Brother Paper

Paper Type	Item
A4 Plain	BP60PA
A4 Glossy	BP60GLA
A4 Inkjet (Photo Matte)	BP60MA

Handling and using special paper

- Store paper in its original packaging, and keep it sealed. Keep the paper flat and away from moisture, direct sunlight and heat.
- The coated side of glossy paper is shiny. Avoid touching the shiny (coated) side. Load glossy paper with the shiny side facing down.
- Avoid touching either side of transparencies, because they absorb water and perspiration easily, and this may cause decreased output quality. Transparencies designed for laser printers/copiers may stain your next document. Use only transparencies recommended for inkjet printing.

⊘ Do not use paper:

- that are damaged, curled, wrinkled, or irregularly shaped

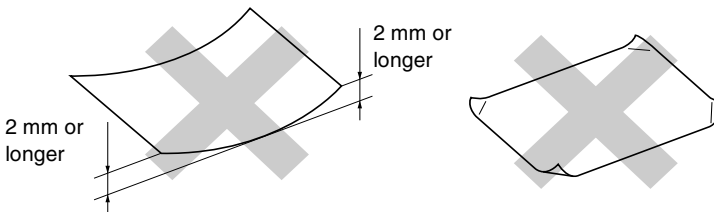

- that are extremely shiny or highly textured
- that were previously printed by a printer
- that cannot be arranged uniformly when stacked
- that are made with a short grain

Paper type and size for each operation

Paper Type	Paper Size		Usage		
			Fax	Copy	Printer
Cut Paper	Letter	216 x 279 mm (8 1/2" x 11")	Yes	Yes	Yes
	A4	210 x 297 mm (8.3" x 11.7")	Yes	Yes	Yes
	Legal	216 x 356 mm (8 1/2" x 14")	Yes	Yes	Yes
	Executive	184 x 267 mm (7 1/4" x 10 1/2")	-	-	Yes
	JIS B5	182 x 257 mm (7.2" x 10.1")	-	-	Yes
	A5	148 x 210 mm (5.8" x 8.3")	-	Yes	Yes
	A6	105 x 148 mm (4.1" x 5.8")	-	-	Yes
Cards	Photo	102 x 152 mm (4" x 6")	-	Yes	Yes
	Photo L	89 x 127 mm (3 1/2" x 5")	-	-	Yes
	Photo 2L	127 x 178 mm (5" x 7")	-	-	Yes
	Index Card	127 x 203 mm (5" x 8")	-	-	Yes
	Post Card 1	100 x 148 mm (3.9" x 5.8")	-	-	Yes
	Post Card 2 (Double)	148 x 200 mm (5.8" x 7.9")	-	-	Yes
Envelopes	C5 Envelope	162 x 229 mm (6.4" x 9")	-	-	Yes
	DL Envelope	110 x 220 mm (4.3" x 8.7")	-	-	Yes
	COM-10	105 x 241 mm (4 1/8" x 9 1/2")	-	-	Yes
	Monarch	98 x 191 mm (3 7/8" x 7 1/2")	-	-	Yes
	JE4 Envelope	105 x 235 mm (4.1" x 9.3")	-	-	Yes
Transparencies	Letter	216 x 279 mm (8 1/2" x 11")	-	Yes	Yes
	A4	210 x 297 mm (8.3" x 11.7")	-	Yes	Yes

Paper weight, thickness and capacity

Paper Type		Weight	Thickness	No. of sheets
Cut Paper	Plain Paper	64 to 120 gsm (17 to 32 lb)	0.08 to 0.15 mm (0.003" to 0.006")	100*
	Inkjet Paper	64 to 200 gsm (17 to 53 lb)	0.08 to 0.25 mm (0.003" to 0.01")	20
	Glossy Paper	Up to 220 gsm (Up to 58 lb)	Up to 0.25 mm (Up to 0.01")	20
Cards	Photo Card	Up to 240 gsm (Up to 64 lb)	Up to 0.28 mm (Up to 0.01")	20
	Index Card	Up to 120 gsm (Up to 32 lb)	Up to 0.15 mm (Up to 0.006")	30
	Post Card	Up to 200 gsm (Up to 53 lb)	Up to 0.23 mm (Up to 0.01")	30
Envelopes		75 to 95 gsm (20 to 25 lb)	Up to 0.52 mm (Up to 0.02")	10
Transparencies		-	-	10

* Up to 50 sheets for Legal size paper (80 gsm).

* Up to 100 sheets of 80 gsm.

Paper capacity of the output paper tray

Output Paper Tray	<p>Up to 50 sheets of 80 gsm (A4)</p> <ul style="list-style-type: none"> ■ Transparencies or glossy paper must be picked up from the output paper tray one page at a time to avoid smudging. ■ Legal paper cannot be stacked on the output paper tray.
-------------------	--

Printable area

The printable area depends on the settings in the application you are using. The figures below show the unprintable areas on cut sheet paper and envelopes.

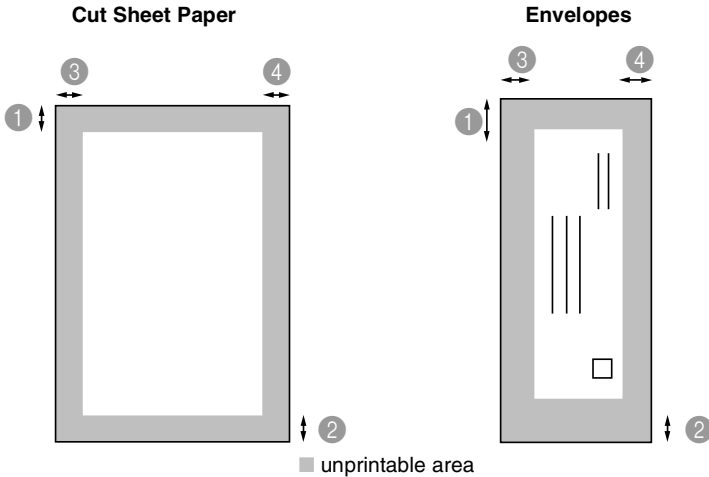

	① Top	② Bottom	③ Left	④ Right
Cut Sheet	3 mm (0 mm)*1	3 mm (0 mm)*1	3 mm (0 mm)*1	3 mm (0 mm)*1
Envelopes	12 mm	24 mm	3 mm	3 mm



*1 When you set the Borderless feature to On.

Printable area depends on the Printer driver settings.

The figures above are approximate and the printable area may vary depending on the type of cut sheet paper you are using.

How to load paper, envelopes and post cards

To load paper or other media

- 1 Pull the paper tray completely out of the machine and remove the output paper tray.

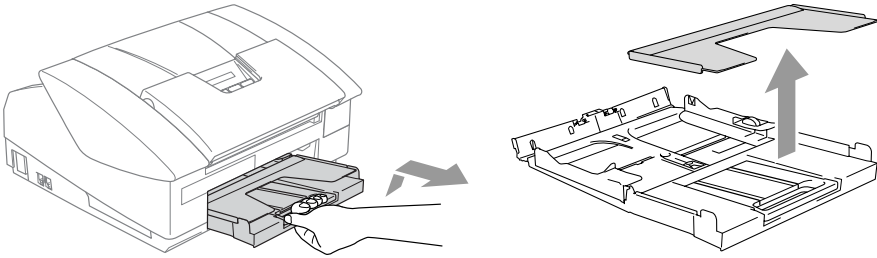

- 2 Press and slide the paper side guide to fit the paper width.

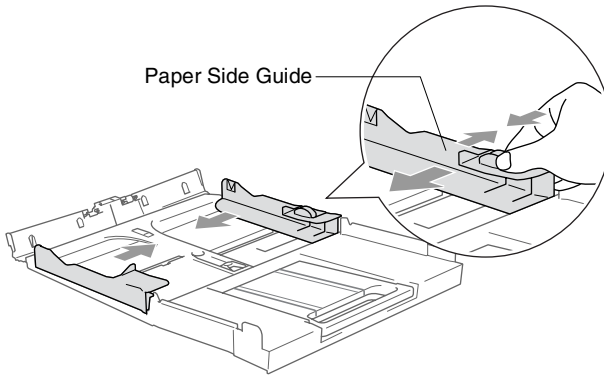

- 3 Pull out the paper support and unfold the paper support flap.

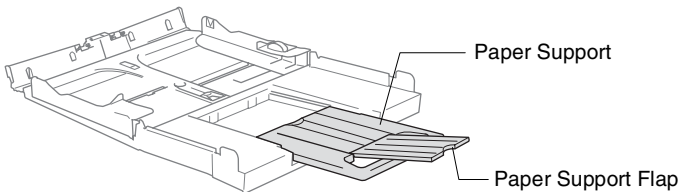

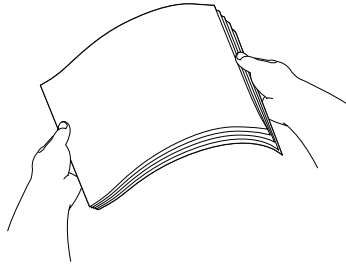

 Use the paper support flap for Letter, Legal and A4.

- 4** Fan the stack of paper well to avoid paper jams and mis-feeds.

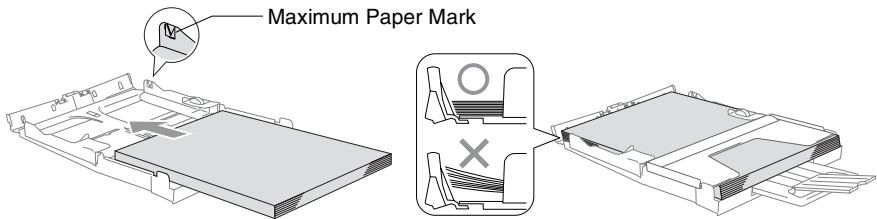

- 5** Gently insert the paper into the paper tray print side down and the leading edge (top of the paper) in first.
Check that the paper is flat in the tray and below the maximum paper mark.



-  ■ Make sure the paper side guides touch the sides of the paper.
- Be careful that you do not push the paper in too far; it may lift at the back of the tray and cause feed problems.
- 6** Put the output paper tray back on and push the paper tray firmly back into the machine.

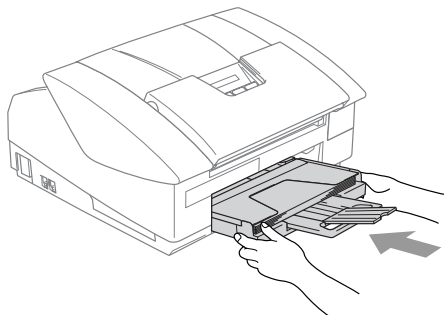

To load envelopes

- Use envelopes that weigh from 75-95 gsm.
- Some envelopes require margin settings in the application. Make sure you do a test print first.
- ⊘ To prevent possible damage to the feeding mechanism, do not use the types of envelopes shown below.

DO NOT USE ENVELOPES:

- that are of a baggy construction
- that are embossed (have raised writing on them)
- that have clasps on them
- that are not sharply creased
- that are preprinted on the inside

■ Glue

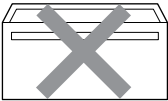

■ Rounded flap

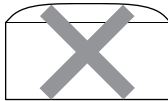

■ Double flap

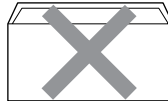

■ Triangular flap



How to load envelopes

- 1 Before loading, press the corners and sides of the envelopes to make them as flat as possible.

-  If the envelopes are 'double-feeding,' put one envelope in the paper tray at a time.

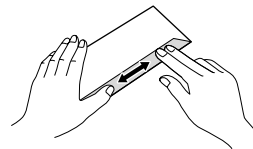
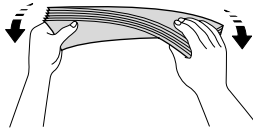
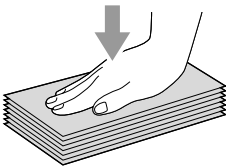

- 2 Insert the envelopes into the paper tray with the address side down and the leading edge (top of the envelopes) in first. Slide the paper side guide to fit the width of the envelopes.

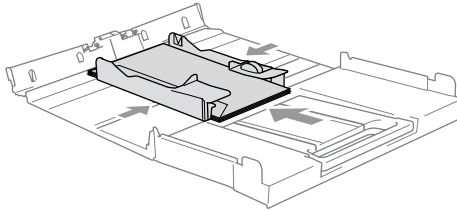

If you have problems when printing on envelopes, try the following suggestions:

- 1 Open the envelope flap.
- 2 Make sure the open flap is either to the side of the envelope or to the back edge of the envelope when printing.
- 3 Adjust the size and margin in your application.

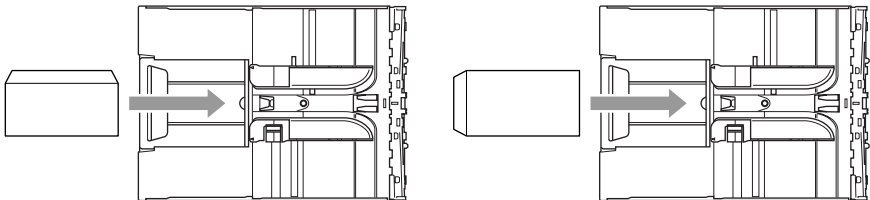

To load post cards

- 1 Raise the paper stop and insert the post cards into the paper tray. Slide the paper side guide to fit the width of the post cards.

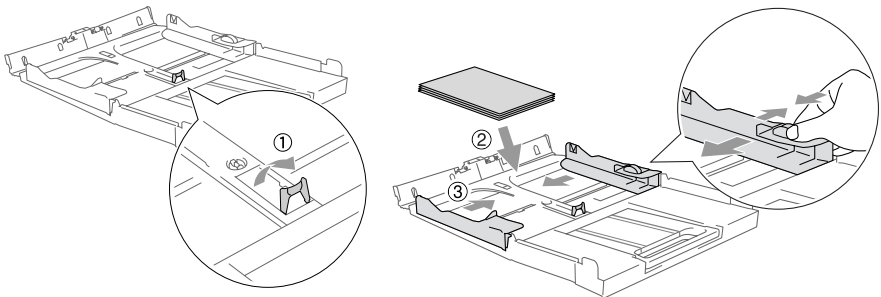

About fax machines

Fax tones and handshake

When someone is sending a fax, the machine sends fax calling tones (CNG tones). These are quiet, intermittent beeps every 4-seconds. You'll hear them after you dial and press **Mono Start** or **Colour Start** and they will continue for about 60 seconds after dialling. During that time, the sending machine must begin the "handshake", or connection, with the receiving machine.

Each time you use automatic procedures to send a fax, you are sending CNG tones over the phone line. You will soon learn to listen for these quiet beeps each time you answer a phone on your fax line, so you will know if you are receiving a fax message.

The receiving fax responds with fax receiving tones, which are loud, chirping sounds. A receiving fax chirps for about 40 seconds over the phone line, and the LCD shows *Receiving*.

If your machine is set to the Fax Only mode, it will answer every call automatically with fax receiving tones. If the other person hangs up, your machine will continue to send the "chirps" for about 40 seconds, and the LCD continues to show *Receiving*. To cancel receiving, press **Stop/Exit**.

The fax 'handshake' is the time in which the sending machine's CNG tones and the receiving machine's "chirps" overlap. This must be for at least 2 to 4 seconds, so both machines can understand how each is sending and receiving the fax. The handshake cannot begin until the call is answered, and the CNG tones only last for about 60 seconds after the number is dialled. So it is important for the receiving machine to answer the call in as few rings as possible.



When you have an external Telephone Answering Device (TAD) on your fax line, your TAD will decide the number of rings before the call is answered.

ECM (Error Correction Mode)

The Error Correction Mode (ECM) is a way for the machine to check a fax transmission while it is in progress. If the machine detects errors during fax transmission, it resends the pages of the fax that had an error. ECM transmissions are only possible between fax machines that both have this feature. If they do, you may send and receive fax messages that are continuously being checked by the machine. Your machine must have enough memory for this feature to work.

2 Getting started

Initial Setup

Setting the Date and Time

When the machine is not in use it will display the date and time. If you set up the Station ID the date and time displayed by your machine will be printed on every fax you send. If there is a power failure, you may have to reset the date and time. No other settings will be affected.

- 1 Press **Menu/Set**, **0**, **2**. 2.Date/Time
- 2 Enter the last two digits of the year.
Press **Menu/Set**.
- 3 Enter two digits for the month.
Press **Menu/Set**.
(For example, enter 09 for September, or 10 for October.)
- 4 Enter two digits for the day.
Press **Menu/Set**. (For example, enter 06 for 6th.)
- 5 Enter the time in 24-Hour format.
Press **Menu/Set**. (For example, enter 15:25 for 3:25 P.M.)
- 6 Press **Stop/Exit**.
The LCD now shows the date and time whenever the machine is in Fax mode.

Setting Tone or Pulse dialling mode (Not available in New Zealand)

- 1 Press **Menu/Set**, **0**, **4**. 4.Tone/Pulse
- 2 Press **▲** or **▼** to select **Pulse** (or **Tone**).
Press **Menu/Set**.
- 3 Press **Stop/Exit**.

Setting the Station ID

You should store your name or company name and fax number so they print on all fax pages you send.

It is important that you enter the fax number in the internationally standardised format, i.e. in accordance with the following strict sequence:

- The “+” (plus) character (by pressing * key)
- Your Country Code (e.g. “61” for Australia, “64” for New Zealand)
- Your local area code minus any leading “0”
- A space
- Your number on the local exchange, using spaces to aid readability as appropriate.

As an example, if the machine is installed in the United Kingdom and the same line is to be used for both fax and voice calls, and your national telephone number is 0161 444 5555, then you must set the fax and telephone number parts of your station ID as:
+44 161 444 5555.

1 Press **Menu/Set**, **0**, **3**.

3.Station ID

2 Enter your fax number

(up to 20 digits).

Press **Menu/Set**.



You cannot enter a hyphen. To enter a space press ► once between numbers.

3 Use the dial pad to enter your name (up to 20 characters).

(See *Entering Text* on page B-9.)

Press **Menu/Set**.

4 Press **Stop/Exit**.



If the Station ID has already been programmed, the LCD will ask you to press **1** to make a change or **2** to exit without changing.

Setting the Phone Line Type

If you are connecting the machine to a line that features a PABX (PBX) or ADSL to send and receive faxes, it is also necessary to change the Phone Line Type accordingly by completing the following steps.

- 1 Press **Menu/Set, 0, 5.** 5.Phone Line Set
- 2 Press **▲** or **▼** to select **PBX** (For Australia and New Zealand only), **ADSL**, **ISDN** (or **Normal**). Press **Menu/Set**.
- 3 Press **Stop/Exit**.

PABX and TRANSFER

The machine is initially set to be connected with PSTN (Public Switched Telephone Network) lines. However, many offices use a central telephone system or Private Automatic Branch Exchange (PABX). Your machine can be connected to most types of PABX. The machine's recall feature supports timed break recall only (TBR). TBR will work with most PABX systems allowing you to gain access to an outside line, or transfer calls to another extension. The feature works when the **Hook** key is pressed.



- You can program a **Hook** keypress as part of a number stored in a One-Touch or Speed-Dial location. When programming the One-Touch or Speed-Dial number (Menu/Set 2-3-1 or 2-3-2) press **Hook** first (the screen displays "!"), then enter the telephone number. If you do this, you do not need to press **Hook** each time before you dial using a One-Touch or Speed-Dial location. (See *Storing numbers for easy dialling* on page 5-1.)
- For FAX-1840C, press **Hook/Hold/Recall** key while holding down the **Shift** key.

General Setup

Setting the Mode Timer (MFC-3240C only)

The machine has three temporary mode keys on the control panel: Fax, Scan and Copy. You can change the number of seconds or minutes the machine takes after the last Scan or Copy operation before it returns to Fax mode. If you select **OFF**, the machine stays in the mode you used last.



- 1** Press **Menu/Set**, **1**, **1**.
- 2** Press **▲** or **▼** to select **0 Sec**, **30 Secs**, **1 Min**, **2 Mins**, **5 Mins** or **Off**.
Press **Menu/Set**.
- 3** Press **Stop/Exit**.

1.Mode Timer

Setting the Mode Timer (FAX-1840C only)

The machine has two temporary mode keys on the control panel: Fax and Copy. You can change the number of seconds or minutes the machine takes after the last Copy operation before it returns to Fax mode. If you select *Off*, the machine stays in the mode you used last.



- 1 Press **Menu/Set**, **1**, **1**.
- 2 Press **▲** or **▼** to select **0 Sec**,
30 Secs, **1 Min**, **2 Mins**, **5 Mins** or **Off**.
- 3 Press **Menu/Set**.
- 4 Press **Stop/Exit**.

1.Mode Timer

Setting the Paper Type

To get the best print quality, set the machine for the type of paper you are using.

1 Press **Menu/Set**, **1**, **2**.

2.Paper Type

2 Press **▲** or **▼** to select **Plain**,
Inkjet, **Glossy** or **Transprncy**.

Press **Menu/Set**.

3 Press **Stop/Exit**.



The machine ejects paper with printed surfaces face up onto the paper tray in the front of the machine. When you use transparencies or glossy paper, remove each sheet immediately to prevent smudging or paper jams.

Setting the Paper Size

You can use five sizes of paper for printing copies: Letter, Legal, A4, A5, and 10 x 15 cm and three sizes for printing faxes: Letter, Legal and A4. When you change the type of paper you load in the machine, you will need to change the setting for Paper Size at the same time so your machine can fit an incoming fax on the page.

1 Press **Menu/Set**, **1**, **3**.

3.Paper Size

2 Press **▲** or **▼** to select **Letter**,
Legal, **A4**, **A5** or **10x15cm**.

Press **Menu/Set**.

3 Press **Stop/Exit**.

Setting the Ring Volume

You can turn the ring `Ring Volume:Off` or you can select the ring volume level.

1 Press **Menu/Set, 1, 4, 1.**



1.Ring

2 Press **▲** or **▼** to select `Low, Med, High` or `Off`.

Press **Menu/Set**.

3 Press **Stop/Exit**.

—OR—

You can adjust the ring volume when your machine is idle (not being used). In Fax mode , press  or  to adjust the volume level. Every time you press these keys, the machine will ring so you can hear the active setting as the LCD shows it. The volume changes with each key press. The new setting will stay until you change it again.

Setting the Beeper Volume

You can change the beeper volume. The default (factory) setting is `Beeper:Low`. When the beeper is on, the machine will beep when you press a key, make a mistake or after you send or receive a fax.

1 Press **Menu/Set, 1, 4, 2.**

2.Beeper

2 Press **▲** or **▼** to select your option.
(`Low, Med, High` or `Off`)

Press **Menu/Set**.

3 Press **Stop/Exit**.

Setting the Speaker Volume

You can select the speaker volume.

- 1 Press **Menu/Set**, **1**, **4**, **3**.
- 2 Press **▲** or **▼** to select **Low**, **Med**, **High** or **Off**.
Press **Menu/Set**.
- 3 Press **Stop/Exit**.

3.Speaker

Turning on Automatic Daylight Savings Time

You can set the machine to change automatically for Daylight Savings Time. It will reset itself forward one hour in the Spring and backward one hour in the Autumn. Make sure you have set the correct day and time in the **Date/Time** setting.

- 1 Press **Menu/Set**, **1**, **5**.
- 2 Press **▲** or **▼** to select **On** (or **Off**).
Press **Menu/Set**.
- 3 Press **Stop/Exit**.

5.Auto Daylight

Setting the LCD Contrast



You can adjust the LCD contrast for a sharper and more vivid display. If you are having difficulty reading the LCD from your position, try changing the contrast setting for improved viewing.

- 1 Press **Menu/Set**, **1**, **7**.
- 2 Press **▲** or **▼** to select **Light** or **Dark**.
Press **Menu/Set**.
- 3 Press **Stop/Exit**.

7.LCD Contrast

3 Setup Send

How to enter Fax mode

Before sending faxes, make sure  (**Fax**) is illuminated in green. If not, press  (**Fax**) to enter Fax mode. The default setting is Fax.

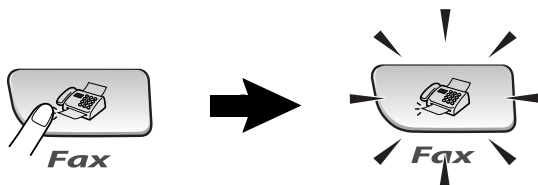

How to dial

You can dial in any of the following ways.

Manual dialling

Press all of the digits of the phone or fax number.



One-Touch dialling

Press the One-Touch Key of the location you want to call.
(See *Storing One-Touch Dial numbers* on page 5-1.)

To dial One-Touch numbers in the black square, hold down **Shift** as you press the One-Touch Key.

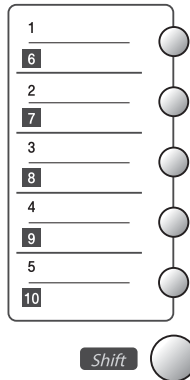

Speed-Dialling

Press **Search/Speed Dial**, **#**, and then the two digit Speed-Dial number. (See *Storing Speed-Dial numbers* on page 5-2.)

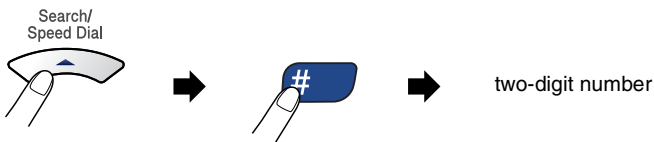

 If the LCD shows **Not Registered** when you enter the Speed-Dial number, a number has not been stored for it.

Search

You can search for names you have stored in the One-Touch and Speed-Dial memories. Press **Search/Speed Dial** and the navigation keys to search. (See *Storing One-Touch Dial numbers* on page 5-1 and *Storing Speed-Dial numbers* on page 5-2.)

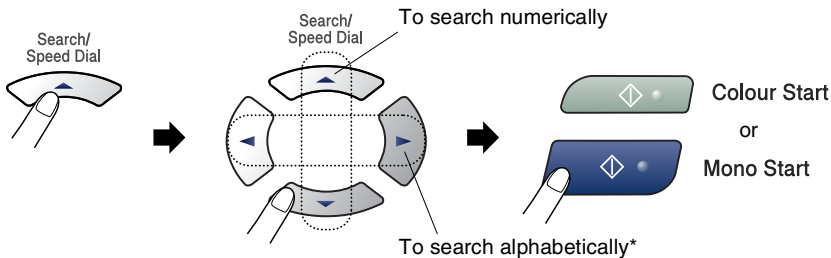

* To search alphabetically, you can use the dial pad to enter the first letter of the name you are looking for.

Fax Redial

If you are sending a fax manually and the line is busy, press **Redial/Pause**, and then press **Mono Start** or **Colour Start** to try again. If you want to make a second call to the last number dialed, you can save time by pressing **Redial/Pause** and **Mono Start** or **Colour Start**.

Redial/Pause only works if you dialed from the control panel. *If you are sending a fax automatically* and the line is busy, the machine will automatically redial up to three times at five minute intervals.

How to Fax (B&W and Colour)

Colour fax transmission

Your machine can send a colour fax to machines that support this feature.

However, colour faxes cannot be stored in the memory. When you send a colour fax, the machine will send it in real time (even if Real Time TX is set to Off).

Faxing from the ADF

Put the document face down in the ADF. To cancel, press **Stop/Exit**.

- 1 If it is not illuminated in green, press  (**Fax**).
- 2 Load your document.
- 3 Dial the fax number.
- 4 Press **Mono Start** or **Colour Start**.
 - The machine starts scanning the document.

 If the memory is full and you are faxing a single page, it will be sent in real time.

Automatic transmission

This is the easiest way to send a fax.

- 1 If it is not illuminated in green, press  (**Fax**).
- 2 Load your document.
- 3 Dial the fax number you want to call. (See *How to dial* on page 3-1.)
- 4 Press **Mono Start** or **Colour Start**.

Manual transmission

Manual transmission lets you hear the dialling, ringing and fax-receiving tones while sending a fax.

- 1 If it is not illuminated in green, press  (**Fax**).
- 2 Load your document.
- 3 Pick up the handset of the machine (FAX-1840C)/external phone (MFC-3240C) and listen for a dial tone.
- 4 Dial the fax number you want to call.
- 5 When you hear the fax tone, press **Mono Start** or **Colour Start**.
- 6 If you picked up the handset replace it.

Sending a fax at the end of a conversation

At the end of a conversation you can send a fax to the other party before you both hang up.

- 1 Ask the other party to wait for fax tones (beeps) and then to press Start or Send key before hanging up.
- 2 If it is not illuminated in green, press  (**Fax**).
- 3 Load your document.
- 4 Press **Mono Start** or **Colour Start**.

Basic sending operations

Sending faxes using multiple settings

When you send a fax you can choose any combination of these settings: contrast, resolution, overseas mode, delayed fax timer, polling transmission or real time transmission.

- 1 If it is not illuminated in green, press  (**Fax**).

After each setting is accepted, the LCD will ask if you want to enter more settings:

- 2 Press **1** to select more settings. The LCD will return to the `Setup Send` menu.

—OR—

Press **2** if you have finished choosing settings and go to the next step.

Contrast

If your document is very light or very dark, you may want to change the contrast.

Use `Light` to send a light document.

Use `Dark` to send a dark document.

- 1 If it is not illuminated in green, press  (**Fax**).

- 2 Load your document.

- 3 Press **Menu/Set, 2, 2, 1**.

- 4 Press **▲** or **▼** to select `Auto`, `Light` or `Dark`.

Press **Menu/Set**.

Fax Resolution

You can use the **Fax Resolution** key to change the setting temporarily (for this fax only). In Fax mode , press **Fax Resolution** and ▲ or ▼ to select the setting you want, and then press **Menu/Set**.

—OR—

You can change the default setting:

- 1 If it is not illuminated in green, press  (**Fax**).
- 2 Load your document.
- 3 Press **Menu/Set**, **2**, **2**, **2**.
- 4 Press ▲ or ▼ to select the resolution you want.

2.Fax Resolution

Press **Menu/Set**.

Standard	Suitable for most typed documents.
Fine	Good for small print and transmits a little slower than Standard resolution.
S.Fine	Good for small print or artwork and transmits slower than Fine resolution.
Photo	Use when the document has varying shades of gray or is a photograph. This has the slowest transmission time.

Dual Access (Not available for colour faxes)

You can dial a number, and begin scanning the fax into memory—even when the machine is sending from memory or receiving faxes. The LCD shows the new job number and available memory.



Your machine normally uses Dual Access. However, to send a colour fax, the machine will send the document in real time (even if `Real Time TX` is `Off`).

The number of pages you can scan into the memory will vary depending on the data that is printed on them.



If you get an `Out of Memory` message while scanning the first page of a fax, press **Stop/Exit** to cancel scanning. If you get an `Out of Memory` message while scanning a subsequent page, you can press **Mono Start** to send the pages scanned so far, or press **Stop/Exit** to cancel the operation.

Real Time Transmission

When you are sending a fax, the machine will scan the documents into the memory before sending. Then, as soon as the phone line is free, the machine will start dialling and sending.

If the memory becomes full, the machine will send the document in real time (even if `Real Time TX` is set to `Off`).

Sometimes, you may want to send an important document immediately, without waiting for memory transmission. You can set `Real Time TX` to `On` for all documents or for the next fax only.

1 If it is not illuminated in green, press  (**Fax**).

2 Load your document.

3 Press **Menu/Set**, **2**, **2**, **5**.

5.Real Time TX

4 To change the default setting, press **▲** or **▼** to select `On` (or `Off`).

Press **Menu/Set**.

—OR—

For the next fax transmission only, press **▲** or **▼** to select `Next Fax Only`.

Press **Menu/Set** and go to Step 5.

5 For the next fax only, press **▲** or **▼** to select `On` (or `Off`).

Press **Menu/Set**.



In Real Time Transmission, the redial feature does not work.



If you are sending a colour Fax, the machine will send it in real time (even if `Real Time TX` is set to `Off`).

Checking job status

Check which jobs are still waiting in the memory to be sent. (If there are no jobs, the LCD shows `No Jobs Waiting`.)

- 1 Press **Menu/Set**, **2**, **6**. `6.Remaining Jobs`
- 2 If you have more than one job waiting, press **▲** or **▼** to scroll through the list.
- 3 Press **Stop/Exit**.

Cancelling a fax in progress

If you want to cancel a fax, while the machine is scanning, dialling or sending it, press **Stop/Exit**.

Cancelling a scheduled job

You can cancel a fax job that is stored and waiting in the memory.

- 1 Press **Menu/Set**, **2**, **6**. `6.Remaining Jobs`
Any jobs that are waiting will appear on the LCD.
- 2 If you have more than one job waiting, press **▲** or **▼** to select the job you want to cancel.
Press **Menu/Set**.
—OR—
If you only have one job waiting, go to Step 3.
- 3 Press **1** to cancel.
To cancel another job go to Step 2.
—OR—
Press **2** to exit without cancelling.
- 4 Press **Stop/Exit**.

Advanced sending operations

Broadcasting (Not available for colour faxes)

Broadcasting is when the same fax message is automatically sent to more than one fax number. You can include Groups, One-Touch, Speed-Dial numbers and up to 50 manually dialled numbers in the same broadcast.

Press **Menu/Set** between each of the numbers. Use **Search/Speed Dial** to help you choose the numbers easily. (To set up Group dial numbers, see *Setting up Groups for Broadcasting* on page 5-4.)

After the broadcast is finished, a Broadcast Report will be printed to let you know the results.

- 1 If it is not illuminated in green, press  (**Fax**).
- 2 Load your document.
- 3 Enter a number using One-Touch, Speed-Dial, a Group number, Search or manual dialling using the dial pad.
(Example: Group number)
- 4 When the LCD displays the fax number or name of the other party, press **Menu/Set**.
You will be asked to enter the next number.
- 5 Enter the next number.
(Example: Speed-Dial number)
- 6 When the LCD displays the fax number or name of the other party, press **Menu/Set**.
- 7 After you have entered all the fax numbers, go to step 8 to start the broadcast.
- 8 Press **Mono Start**.



- If you did not use up any of the numbers for Groups, access codes or credit card numbers, you can 'broadcast' faxes to as many as 100 different numbers.
- The available memory will vary depending on the types of jobs in the memory and the number of locations used for broadcasting. If you broadcast to the maximum numbers available, you will not be able to use Dual Access and Delayed fax.
- Enter the long dialling sequence numbers as you would normally, but remember that each One-Touch and Speed-Dial number counts as one number, so the number of locations you can store becomes limited.
- If the memory is full, press **Stop/Exit** to stop the job or if more than one page has been scanned, press **Mono Start** to send the portion that is in the memory.

Overseas Mode

If you are having difficulty sending a fax overseas due to possible interference on the phone line, we recommend that you turn on the Overseas Mode. After you send a fax using this feature, the feature will turn itself off.

- 1 If it is not illuminated in green, press  (**Fax**).
- 2 Load your document.
- 3 Press **Menu/Set**, **2**, **2**, **7**.
- 4 Press **▲** or **▼** to select **On** (or **Off**).
Press **Menu/Set**.

7.Overseas Mode

Delayed Fax (Not available for colour faxes)

During the day you can store up to 50 faxes in the memory to be sent within 24 hours. These faxes will be sent at the time of day you enter in Step 4.

1 If it is not illuminated in green, press  (**Fax**).

2 Load your document.

3 Press **Menu/Set**, **2**, **2**, **3**.

3.Delayed Fax

4 Press **Menu/Set** to accept the displayed time.

—OR—

Enter the time you want the fax to be sent (in 24-hour format).

Press **Menu/Set**.

(For example, enter 19:45 for 7:45 PM.)

5 Press **1** to leave the documents waiting in the ADF.

1.Doc 2.Memory

—OR—

Press **2** to scan the documents into the memory.



The number of pages you can scan into the memory depends on the amount of data that is printed on each page.

Delayed Batch Transmission (Not available for colour faxes)

Before sending the delayed faxes, your machine will help you economize by sorting all the faxes in the memory by destination and scheduled time. All delayed faxes that are scheduled to be sent at the same time to the same fax number will be sent as one fax to save transmission time.

1 If it is not illuminated in green, press  (**Fax**).

2 Press **Menu/Set, 2, 2, 4**.

4.Batch TX

3 Press **▲** or **▼** to select **On** (or **Off**).

Press **Menu/Set**.

4 Press **Stop/Exit**.

Setup for Polled Transmit (Standard) (Not available for colour faxes)

Polled Transmit is when you set up the machine to wait with a document so another fax machine can retrieve it.

1 If it is not illuminated in green, press  (**Fax**).

2 Load your document.

3 Press **Menu/Set, 2, 2, 6**.

6.Polled TX

4 Press **▲** or **▼** to select **Standard**.

Press **Menu/Set**.

5 Press **1** to leave documents in the ADF. The document will remain in the ADF until the machine is polled. If you need to use your machine before the polled transmit occurs, you must first cancel this job.

1.Doc 2.Memory

—OR—

Press **2** to scan the document into memory. The document will be stored and can be retrieved from any other fax machine until you delete the fax in memory by using the Cancelling a Job menu setting.

Setup for Polled Transmit with Secure Code (Not available for colour faxes)

When you choose `Polling:Secure`, anyone who polls the machine must enter the polling secure code.

1 If it is not illuminated in green, press  (**Fax**).

2 Load your document.

3 Press **Menu/Set**, **2**, **2**, **6**.

6.Polled TX

4 Press **▲** or **▼** to select `Secure`.

Press **Menu/Set**.

5 Enter a four-digit number.

Press **Menu/Set**.

6 Press **1** to leave documents in the ADF. The document will remain in

1.Doc 2.Memory

the ADF until the machine is polled. If you need to use your machine before the polled transmission occurs, you must first cancel this job.

—OR—

Press **2** to scan the document into memory. The document will be stored and can be retrieved from any other fax machine until you delete the fax in memory by using the `Cancelling a Job` menu setting. (See *Cancelling a scheduled job* on page 3-10.)



You can use Secure Polling only with another Brother fax machine.

TX Lock (Key Lock for some countries)

TX Lock lets you prevent unauthorized access to the machine.

While TX Lock is **On** the following operations are available:

- Receiving faxes
- Fax Forwarding (If Fax Forwarding was already **On**)
- Remote Retrieval (If Fax Storage was already **On**)

While TX Lock is **On** the following operations are NOT available:

- Sending faxes
- Copy
- PC printing (MFC-3240C only)
- PC scanning (MFC-3240C only)



You will not be able to continue to schedule Delayed Faxes or Polling jobs. However, any pre-scheduled Delayed Faxes will be sent when you turn TX Lock **On**, so they won't be lost.

If you have selected Fax Forwarding or Fax Storage (**Menu/Set, 2, 5**) *before* you turn TX Lock **On**, then Fax Forwarding and Remote Retrieval will continue to work.



To print the faxes in memory, turn TX Lock **Off**.

Setting up the password



If you forget the TX Lock password, please contact your Brother dealer or Brother for assistance.

1 Press **Menu/Set**, **2**, **0**, **1**.

1.TX Lock

2 Enter a 4-digit number for the password.

Press **Menu/Set**.

3 If the LCD shows *Verify* :, re-enter the password.

Press **Menu/Set**.

Changing the TX Lock password

1 Press **Menu/Set**, **2**, **0**, **1**.

1.TX Lock

2 Press **▲** or **▼** to select *Set Password*.

Press **Menu/Set**.

3 Enter a 4-digit number for the current password.

Press **Menu/Set**.

4 Enter a 4-digit number for a new password.

Press **Menu/Set**.

5 If the LCD shows *Verify* :, re-enter the password.

Press **Menu/Set**.

Turning TX Lock on

1 Press **Menu/Set**, **2**, **0**, **1**.

1.TX Lock

2 Press **▲** or **▼** to select **Set TX Lock**.

Press **Menu/Set**.

3 Enter the registered 4-digit password.

Press **Menu/Set**.

The machine goes offline and the LCD shows **TX Lock Mode**.

Turning TX Lock off

1 Press **Menu/Set**.

2 Enter the registered 4-digit password.

Press **Menu/Set**.

TX lock is automatically turned off.



If you enter the wrong Password, the LCD shows **Wrong Password** and stays offline. The machine will stay in **TX Lock Mode** until the registered password is entered.

4 Setup Receive

Basic receiving operations

Choosing the Receive Mode

There are four different Receive Modes for your machine. You can choose the mode that best suits your needs.

LCD	How it works	When to use it
Fax Only (automatic receive)	The machine automatically answers every call as a fax.	For dedicated fax lines.
Fax/Tel (fax and telephone) (with an external or extension telephone for models without a handset)	The machine controls the line and automatically answers every call. If the call is a fax it will receive the fax. If the call is not a fax it will ring (pseudo/double ring) for you to pick up the call.	Use this mode if you expect to receive lots of fax messages and few telephone calls. You cannot have an answering machine on the same line, even if it is on a separate wall socket/phone socket on the same line. You cannot use the telephone company's Voice Mail in this mode.
External TAD (with an external answering machine only)	The external answering machine (TAD) automatically answers every call. Voice messages are stored on the external TAD. Fax messages are printed.	Use this mode if you have connected an answering machine to your machine. The External TAD setting works only with an external answering machine. Ring Delay does not work in this setting.
Manual (manual receive) (with an external or extension telephone for models without a handset)	You control the phone line and must answer every call yourself.	Use this mode if you do not receive many fax messages. If you answer and hear fax tones, wait until the MFC takes over the call, then hang up. (See <i>Fax Detect (MFC-3240C only)</i> on page 4-4.) Note: If you use a computer modem on the same line MFC Faxing will not operate correctly.

To select or change your Receive Mode

- 1 Press **Menu/Set**, **0**, **1**.
- 2 Press **▲** or **▼** to select **Fax Only**,
Fax/Tel, **External TAD** or **Manual**.
Press **Menu/Set**.
- 3 Press **Stop/Exit**.

1.Receive Mode

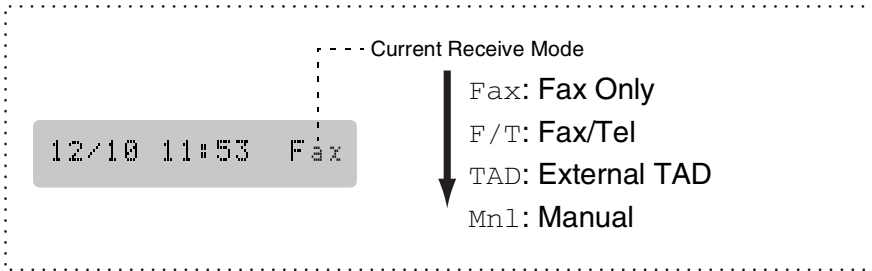

Setting the Ring Delay

The Ring Delay sets the number of times the machine rings before it answers in **Fax Only** or **Fax/Tel** mode. If you have extension phones on the same line as the machine, keep the Ring Delay setting of 6.

(See *Operation from extension telephones* on page A-14 and *Fax Detect (MFC-3240C only)* on page 4-4 or *Fax Detect (FAX-1840C only)* on page 4-5.)

- 1 If it is not illuminated in green, press  (**Fax**).
- 2 Press **Menu/Set**, **2**, **1**, **1**.
- 3 Press **▲** or **▼** to select how many times the line rings before the machine answers (02 - 10 for Australia, 01 - 10 for New Zealand, 00 - 10 for some countries).
Press **Menu/Set**.
(If you select 00, the line won't ring at all.)
- 4 Press **Stop/Exit**.

1.Ring Delay

Setting the F/T Ring Time (Fax/Tel mode only)

If you set the Receive Mode to Fax/Tel, you'll need to decide how long the machine will signal you with its special pseudo/double-ring when you have a *voice* call. (If it's a fax call, the machine prints the fax.)

This pseudo/double-ring happens after the initial ringing from the phone company. Only the machine rings and no other phones on the same line will ring with the special pseudo/double-ring. However, you can still answer the call on any telephone. (See *Fax/Tel mode* on page A-15.)

- 1** If it is not illuminated in green, press  **(Fax)**.
- 2** Press **Menu/Set, 2, 1, 2**. 2.F/T Ring Time
- 3** Press **▲** or **▼** to select how long the machine will ring to alert you that you have a voice call (20, 30, 40 or 55 seconds for New Zealand and China).
Press **Menu/Set**.
- 4** Press **Stop/Exit**.

 Even if the caller hangs up during the pseudo/double-ringing, the machine will continue to ring for the set time.

Fax Detect (MFC-3240C only)

When you use this feature, you don't have to press **Mono Start**, **Colour Start**, or the Fax Receive Code *51 (*91 for New Zealand) when you answer a fax call. Selecting `Fax Detect:On` allows the machine to receive fax calls automatically, even if you lift the handset of an extension or external phone. When you see `Receiving` on the LCD or when you hear 'chirps' through the handset of an extension phone connected to another wall socket/phone socket, just replace the handset and your machine will do the rest.



- If this feature is set to `On`, but your machine does not connect a fax call when you lift an extension or external phone handset, press the Fax Receive Code *51 (*91 for New Zealand).
- If you send faxes from a computer on the same phone line and the machine intercepts them, set Fax Detect to `Off`.
- Selecting `Off` means you'll have to activate the machine yourself by pressing **Mono Start** or **Colour Start** on the machine
—OR—

Press *51 (*91 for New Zealand) on the external or extension phone if you are not at your machine.

(See *Operation from extension telephones* on page A-14.)

1 If it is not illuminated in green, press  (**Fax**).

2 Press **Menu/Set**, **2**, **1**, **3**.

3. Fax Detect

3 Use ▲ or ▼ to select `On` (or `Off`).

Press **Menu/Set**.

4 Press **Stop/Exit**.

Fax Detect (FAX-1840C only)

When you use this feature, you don't have to press **Mono Start** or **Colour Start**, or the Fax Receive Code ***51** when you answer a fax call. Selecting `Fax Detect : On` allows the machine to receive fax calls automatically, even if you lift the handset of an extension or external phone. When you see `Receiving` on the LCD or when you hear (chirps) through the handset of an extension phone connected to another phone socket, just replace the handset and your machine will do the rest. Selecting `Semi` lets the machine receive the call only if you've answered it at the machine.



- If this feature is set to `On`, but your machine does not connect a fax call when you lift an extension or external phone handset, press the Fax Receive Code ***51**.
- If you send faxes from a computer on the same phone line and the machine intercepts them, set Fax Detect to `Off`.
- Selecting `Off` means you'll have to activate the machine yourself by pressing **Mono Start** or **Colour Start** on the machine
—OR—
Press ***51** on the external or extension phone if you are not at your machine. (See *Operation from extension telephones* on page A-14.)

1 If it is not illuminated in green, press  (**Fax**).

2 Press **Menu/Set**, **2**, **1**, **3**.

`3.Fax Detect`

3 Use **▲** or **▼** to select `On`, `Semi` or `Off`.

Press **Menu/Set**.

4 Press **Stop/Exit**.

Printing a reduced incoming fax (Auto Reduction)

If you choose `Reduction:On`, the machine automatically reduces an incoming fax to fit on one page of A4, letter or legal size paper. The machine calculates the reduction ratio by using the page size of the document and your Paper Size setting (**Menu/Set, 1, 3**).

- 1 If it is not illuminated in green, press  (**Fax**).
- 2 Press **Menu/Set, 2, 1, 5**. 5.Auto Reduction
- 3 Use **▲** or **▼** to select `On` (or `Off`).
Press **Menu/Set**.
- 4 Press **Stop/Exit**.



- Turn on this setting if you receive faxes that are split on two pages. However, if the document is too long, the machine may print it on two pages.
- If left and right margins are cut off, turn on this setting.

Receiving a fax at the end of a conversation

At the end of a conversation you can ask the other party to fax you information before you both hang up.

- 1 Ask the other party to place the document in their machine and to press `Start` or `Send` key.
- 2 When you hear the other machine's CNG tones (beeps), press **Mono Start** or **Colour Start**.
- 3 If you picked up the handset, replace it.

Printing a fax from the memory

If you have selected Fax Forwarding or Fax Storage (**Menu/Set, 2, 5, 1**), you can still print a fax from the memory when you are at your machine. (See *Setting Fax Storage* on page 6-2.)

1 Press **Menu/Set, 2, 5, 3**.

3.Print Document

2 Press **Mono Start**.

Reception into memory (Not available for colour fax reception)

As soon as the paper tray becomes empty during fax reception, the screen will display *No Paper Fed*; please put some paper in the paper tray. (See *How to load paper, envelopes and post cards* on page 1-14.)

If the **Memory Receive** is **On** at this time...

The current fax reception will continue, with the remaining page(s) being stored in memory, subject to available memory. Subsequent incoming faxes will also be stored into memory until the memory is full, following this no further incoming fax calls will be automatically answered. To print all data put fresh paper in the paper tray and press **Mono Start** or **Colour Start**.

If the **Memory Receive** is **Off** at this time...

The current fax reception will continue, with the remaining page(s) being stored in memory, subject to available memory. Subsequent incoming fax calls will not be automatically answered until fresh paper is put in the paper tray. To print the last fax received, put paper in the paper tray and press **Mono Start** or **Colour Start**.

1 If it is not illuminated in green, press  (**Fax**).

2 Press **Menu/Set, 2, 1, 6**.

6.Memory Receive

3 Use **▲** or **▼** to select **On** (or **Off**).

Press **Menu/Set**.

4 Press **Stop/Exit**.

Polling

Polling is the process of retrieving faxes from another fax machine. You can use your machine to 'poll' other machines, or you can have someone poll your machine.

Everyone who is involved in Polling needs to set up their fax machines for Polling. When someone polls your machine to receive a fax, they pay for the call. If you poll someone's fax machine to receive a fax, you pay for the call.



Some fax machines do not respond to the Polling feature.

Secure Polling

Secure Polling is a way to keep your documents and others from falling into the wrong hands while the machine is set up for polling. You can use Secure Polling only with another Brother fax machine. Anyone who polls to receive a fax must enter the polling secure code.

Setup for Polling Receive (Standard)

Polling Receive is when you call another fax machine to receive a fax from it.

1 If it is not illuminated in green, press  **(Fax)**.

2 Press **Menu/Set, 2, 1, 7**.

7.Polling RX

3 Press **▲** or **▼** to select **Standard**.

Press **Menu/Set**.

4 Enter the fax number you are polling.

Press **Mono Start** or **Colour Start**.

Setup for Polling Receive with Secure Code

You need to make sure you are using the same secure code as the other party.

- 1** If it is not illuminated in green, press  (**Fax**).
- 2** Press **Menu/Set, 2, 1, 7**. 7.Polling RX
- 3** Press **▲** or **▼** to select
Polling:Secure.
Press **Menu/Set**.
- 4** Enter a four-digit secure code.
This is the same as the security code of the fax machine you are polling.
Press **Menu/Set**.
- 5** Enter the fax number you are polling.
- 6** Press **Mono Start** or **Colour Start**.

Setup Delayed Polling Receive

You can set the machine to begin Polling Receive at a later time.



- 1** If it is not illuminated in green, press  (**Fax**).
- 2** Press **Menu/Set, 2, 1, 7**. 7.Polling RX
- 3** Press **▲** or **▼** to select
Polling:Timer.
Press **Menu/Set**.
- 4** Enter the time (in 24-hour format) you want to begin polling.
For example, enter 21:45 for 9:45 PM.
Press **Menu/Set**.
- 5** Enter the fax number you are polling.
Press **Mono Start** or **Colour Start**.
The machine makes the polling call at the time you entered.



You can set up only one Delayed Polling.

Sequential Polling

The machine can request documents from several fax units in a single operation. You just specify several destinations in Step 5. Afterwards, a Sequential Polling Report will be printed.

- 1 If it is not illuminated in green, press  (**Fax**).
 - 2 Press **Menu/Set**, **2**, **1**, **7**. 7.Polling RX
 - 3 Press **▲** or **▼** to choose *Standard*, *Secure* or *Timer*.
Press **Menu/Set** when the screen displays the setting you want.
 - 4 If you selected *Standard*, go to Step 5.
 - If you selected *Secure*, enter a four-digit number and press **Menu/Set**, and then go to Step 5.
 - If you selected *Timer*, enter the time (in 24-hour format) you want to begin polling and press **Menu/Set**, and then go to Step 5.
 - 5 Specify the destination fax machines, which you wish to poll by using One-Touch, Speed-Dial, Search, a Group (see *Setting up Groups for Broadcasting* on page 5-4) or the dial pad. You must press **Menu/Set** between each location.
 - 6 Press **Mono Start** or **Colour Start**.
The machine polls each number or group in turn for a document.
-  Press **Stop/Exit** while the machine is dialling to cancel the polling process.
- To cancel all sequential polling receive jobs, press **Menu/Set**, **2**, **6**. (See *Cancelling a scheduled job* on page 3-10.)

5 Quick-Dial numbers and dialling options

Storing numbers for easy dialling

You can set up your machine to do following types of easy dialling: One-Touch, Speed-Dial and Groups for Broadcasting faxes. When you dial a quick-dial number, the LCD shows the name, if you stored it, or the number.

 *If you lose electrical power, the quick-dial numbers that are in the memory will not be lost.*

Storing One-Touch Dial numbers

Your machine has One-Touch keys where you can store fax or phone numbers for automatic dialling. Two numbers can be stored on each One-Touch key. To access the second number, which is shown in a black square on the control panel, hold down **Shift** as you press the One-Touch key. (See *One-Touch dialling* on page 3-2.)

One-Touch keys are located on the left side of the control panel.

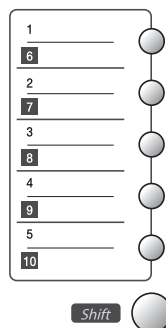

1 Press **Menu/Set**, **2**, **3**, **1**.

Set Quick-Dial

2 Press the One-Touch key where you want to store a number.

1.One-Touch Dial

3 Enter the phone or fax number (up to 20 digits).

Press **Menu/Set**.

- If you want to enter a pause in the dialling sequence (for example, to access an outside line), press **Redial/Pause** as you are entering the digits.

Each key press of **Redial/Pause** enters a 3.5 second pause when the number is dialled, displayed by a dash on the screen.

- 4 Use the dial pad to enter the name (up to 15 characters).
Press **Menu/Set**.
(You can use the chart on page B-9 to help you enter letters.)
—OR—
Press **Menu/Set** to store the number without a name.
- 5 Go to Step 2 to store another One-Touch number.
—OR—
Press **Stop/Exit**.

Storing Speed-Dial numbers

You can store Speed-Dial numbers, so that when you dial you will only have to press a few keys (**Search/Speed Dial**, **#**, the two-digit number, and **Mono Start** or **Colour Start**). The machine can store 40 Speed-Dial numbers.

- 1 Press **Menu/Set**, **2**, **3**, **2**. 2.Speed Dial
- 2 Use the dial pad to enter a two-digit Speed-Dial location number (01-40).
(For example, press **05**.)
Press **Menu/Set**.
- 3 Enter the phone or fax number (up to 20 digits).
Press **Menu/Set**.
- 4 Use the dial pad to enter the name (up to 15 characters).
Press **Menu/Set**.
(You can use the chart on page B-9 to help you enter letters.)
—OR—
Press **Menu/Set** to store the number without a name.
- 5 Go to Step 2 to store another Speed-Dial number.
—OR—
Press **Stop/Exit**.

Changing One-Touch and Speed-Dial numbers

If you try to store a One-Touch or Speed-Dial number where a number has already been stored, the LCD will show the name that has been stored there (or number) and will ask you to do one of the following:

1 Press **1** to change the stored number.

05:Mike

—OR—

1.Change 2.Exit

Press **2** to exit without making a change.

How to change the stored number or name:

- If you want to change a character, use ◀ or ▶ to position the cursor under the character you want to change, and then type over it.
- If you want to erase the whole number or whole name, press **Stop/Exit** when the cursor is under the first digit or letter. The characters above and to the right of the cursor will be deleted.

2 Enter a new number.

Press **Menu/Set**.

3 Follow the directions beginning at Step 4 in Storing One-Touch Dial numbers and Storing Speed-Dial numbers. (See page 5-1 and 5-2.)

Setting up Groups for Broadcasting

Groups, which can be stored on a One-Touch key or a Speed-Dial location, allow you to send the same fax message to many fax numbers by pressing only a One-Touch key and **Mono Start** or **Search/Speed Dial**, #, the two-digit location and **Mono Start**.

First, you will need to store each fax number as a One-Touch or Speed-Dial number. Then, you can combine them into a Group, *Each Group uses up a One-Touch key or a Speed-Dial location*. Finally, you can have up to six small Groups, or you can assign up to 49 numbers to one large Group.

(See *Storing Speed-Dial numbers* on page 5-2 and *Changing One-Touch and Speed-Dial numbers* on page 5-3.)

1 Press **Menu/Set**, **2**, **3**, **3**.

3.Setup Groups

2 Decide where you wish to store the Group.

—AND—

Press a One-Touch key.

—OR—

Press **Search/Speed Dial** and enter the two-digit location, and then press **Menu/Set**.

3 Use the dial pad to enter the Group number (1 to 6).

Press **Menu/Set**.

(For example, press **1** for Group 1.)

4 To include One-Touch or Speed-Dial numbers in the Group, enter them as follows.

For example, for One-Touch key **2**, press One-Touch key **2**. For a number in a black square, such as One-Touch key **6**, press **Shift** and One-Touch key **6**.

For Speed-Dial location 09, press **Search/Speed Dial**, and then press **09** on the dial pad. The LCD shows * 02, #09 (or * 06, #09).

- 5 Press **Menu/Set** to accept the numbers for this Group.
 - 6 Use the dial pad and the chart on page B-9 to enter a name for the Group.
Press **Menu/Set**.
(For example, NEW CLIENTS)
 - 7 Press **Stop/Exit**.
-  You can print a list of all One-Touch and Speed-Dial numbers. (See *Printing reports* on page 7-3.) Group numbers will be marked in the GROUP column.

Dialling options

Access codes and credit card numbers

Sometimes you may want to choose from several long distance carriers when you make a call. Rates may vary depending on the time and destination. To take advantage of low rates, you can store the access codes or long-distance carriers and credit card numbers as One-Touch and Speed-Dial numbers. You can store these long dialling sequences by dividing them and setting them up as separate One-Touch and Speed-Dial numbers in any combination. You can even include manual dialling using the dial pad. (See *Storing One-Touch Dial numbers* on page 5-1 and *Storing Speed-Dial numbers* on page 5-2.)

For example, perhaps you have stored '555' on One-Touch key **1** and '7000' on One-Touch key **2**. If you press One-Touch key **1**, One-Touch key **2**, and **Mono Start** or **Colour Start**, you will dial '555-7000'.

To temporarily change a number, you can substitute part of the number with manual dialling using the dial pad.

For example, to change the number to 555-7001 you could press One-Touch key **1** and then press **7001** using the dialling pad.



If you must wait for another dial tone or signal at any point in the dialling sequence, store a pause there in the number by pressing **Redial/Pause**. Each key press adds a 3.5-second delay.

Pause

Press **Redial/Pause** to insert a 3.5-second pause between numbers. If you are dialling overseas, you can press **Redial/Pause** as many times as needed to increase the length of the pause.

Tone or Pulse (Not available in New Zealand)

If you have a Pulse dialling service, but need to send Tone signals (for example, for telephone banking), follow the instructions below. If you have Touch Tone service, you will not need this feature to send tone signals.

1 For FAX-1840C, lift the handset.

—OR—

For MFC-3240C, lift the handset of the external telephone.

2 Press # on the machine's control panel. Any digits dialled after this will send tone signals.

When you hang up, the machine will return to the Pulse dialling service.

Telephone (voice) operation (FAX-1840C only)

You can use the machine to make voice telephone calls by dialling manually or by using Search, One-Touch Dial or Speed-Dial memory. You can use the handset to make and receive calls.

When you dial a Quick-Dial number, the LCD shows the name you've stored, or if you haven't stored a name, the fax number you've stored.

How to dial

See *How to dial* on page 3-1.

Making a telephone call

- 1 Pick up the handset.
- 2 When you hear a dial tone, dial the number using the dial pad, One-Touch, Speed-Dial and Search.
- 3 To hang up, replace the handset.

Tel

This key is used to enter into a conversation after having picked up the handset of an external telephone in F/T pseudo-ringing.

Also, if you press **Hook/Hold/Recall** when you are talking lifting the external telephone's handset with the other end, you can hear the other end from the machine's monitor speaker, but the other end cannot hear you.

Mute (FAX-1840C only)

- 1 Press **Hook/Hold/Recall** to put a call on Hold.
- 2 You can replace the handset without disconnecting the call.
Pick up the machine handset to release the call from Hold.
Picking up an extension handset will not release the call from Hold.

6

Remote Fax Options (Not available for colour faxes)



You can only use one remote fax option at a time:
Fax Forwarding—OR—Fax Storage—OR—Off.

You can change your selection at any time (**Menu/Set, 2, 5, 1**).
(See *Turning off Remote Fax Options* on page 6-2.)

Setting up Fax Forwarding

When you select Fax Forward, your machine stores the received fax in the memory. The machine will then dial the fax number you've programmed and forwards the fax message.

1 Press **Menu/Set, 2, 5, 1**.

1.Fwd/Page/Store

2 Press **▲** or **▼** to select

Fax Forward.

Press **Menu/Set**.

The LCD will ask you to enter the fax number to which faxes will be forwarded.

3 Enter the forwarding number (up to 20 digits).

Press **Menu/Set**.

4 Press **▲** or **▼** to select On or Off.

Backup Print:On

Press **Menu/Set**.



If you select Backup Print:On, the machine will also print the fax at your machine so you will have a copy if there is a power failure before it is forwarded.

5 Press **Stop/Exit**.

Setting Fax Storage

If you select Fax Storage, your machine stores the received fax in the memory. You will be able to retrieve fax messages from another location using the Remote Retrieval commands.

1 Press **Menu/Set, 2, 5, 1**.

1.Fwd/Page/Store

2 Press **▲** or **▼** to select
Fax Storage.

Press **Menu/Set**.

3 Press **Stop/Exit**.



If you have set Fax Storage, a backup copy of the received fax will automatically be printed at the machine.

Turning off Remote Fax Options

If you set the Remote Fax Options to **Off** and there are faxes in your machine's memory, the LCD will give you two options.

- If you press **1**, all unprinted faxes will be printed and erased before the setting turns off. If a backup copy has already been printed it will not be printed again.
- If you press **2**, the memory will not be erased and the setting will be unchanged.

(See *Printing a fax from the memory* on page 4-7.)

Setting your Remote Access Code

The remote access code lets you access the Remote Retrieval features when you are away from your machine. Before you use the remote access and retrieval features, you have to set up your own code. The default code is inactive code (--- *).

1 Press **Menu/Set, 2, 5, 2**.

2.Remote Access

2 Enter a three-digit code using numbers **0-9, ***.

Press **Menu/Set**. (The preset ‘*’ cannot be changed.)

 Do not use the same code which is set in your Fax Receive Code (***51**, ***91** for New Zealand) or Telephone Answer Code (**#51**, **#91** for New Zealand).
(See *Operation from extension telephones* on page A-14.)

3 Press **Stop/Exit**.

 You can change your code at any time by entering a new one. If you want to make your code inactive, press **Stop/Exit** in Step 2 to restore the inactive setting (--- *).

Remote Retrieval

You can call your machine from any touch tone telephone or fax machine, then use the Remote Access Code and remote commands to retrieve fax messages.

Using your Remote Access Code

- 1** Dial your fax number from a telephone or another fax machine using touch tone.
 - 2** When your machine answers, immediately enter your Remote Access Code (3 digits followed by *).
 - 3** The machine signals if it has received messages:
 - 1 long beep — Fax messages**
 - No beeps — No messages**
 - 4** The machine gives two short beeps to tell you to enter a command. The machine will hang up if you wait longer than 30 seconds to enter a command. The machine will beep three times, if you enter an invalid command.
 - 5** Press **90** to reset the machine when you've finished.
 - 6** Hang up.
-  If your machine is set to `Manual` mode and you want to use the remote retrieval features, you can access your machine by waiting about 2 minutes after it starts ringing, and then entering the Remote Access Code within 30 seconds.

Remote commands

Follow the commands below to access features when you are away from the machine. When you call the machine and enter your Remote Access Code (3 digits followed by *), the system will give two short beeps and you must enter a remote command.

Remote commands	Operation details
95 Change the Fax Forwarding or Fax Storage settings	
1 OFF	You can select OFF after you have retrieved or erased all your messages.
2 Fax Forwarding	If you hear one long beep, the change has been accepted. If you hear three short beeps, you cannot change it because the conditions have not been met (for example, registering a Fax Forwarding number). You can register your Fax Forwarding number by entering 4. (See <i>Changing your Fax Forwarding number</i> on page 6-6.) Once you have registered the number, Fax Forwarding will work.
4 Fax Forwarding number	
6 Fax Storage	
96 Retrieve a fax	
2 Retrieve all faxes	Enter the number of a remote fax machine to receive stored fax message(s). (See page 6-6.)
3 Erase faxes from the memory	If you hear one long beep, fax messages have been erased from the memory.
97 Check the receiving status	
1 Document	You can check whether your machine has received any faxes. If yes, you will hear one long beep. If no, you will hear three short beeps.
98 Change the Receive Mode	
1 External TAD	If you hear one long beep, your change has been accepted.
2 Fax/Tel	
3 Fax Only	
90 Exit	Press 90 to exit Remote Retrieval. Wait for the long beep, then replace the handset.

Retrieving fax messages

You can call your machine from any touch tone phone and have your fax messages sent to a fax machine.

- 1 Dial your fax number.
 - 2 When your machine answers, immediately enter your Remote Access Code (3 digits followed by *). If you hear one long beep, you have messages.
 - 3 As soon as you hear two short beeps, use the dial pad to press **962**.
 - 4 Wait for the long beep, and then use the dial pad to enter the number of the remote fax machine where you want your fax messages sent to followed by ## (up to 20 digits).
-  You cannot use * and # as dial numbers. However, press # if you want to store a pause.
- 5 Hang up after you hear your machine beep. Your machine will call the other machine, which will then print your fax messages.

Changing your Fax Forwarding number

You can change the default setting of your fax forwarding number from another telephone or fax machine using touch tone.

- 1 Dial your fax number.
 - 2 When your machine answers, immediately enter your Remote Access Code (3 digits followed by *). If you hear one long beep, you have messages.
 - 3 When you hear two short beeps, use the dial pad to press **954**.
 - 4 Wait for the long beep, and then use the dial pad to enter the new number of the remote fax machine where you want your fax messages forwarded followed by ## (up to 20 digits).
-  You cannot use * and # as dial numbers. However, press # if you want to store a pause.
- 5 Hang up after you hear your machine beep.

7 Printing reports

Fax settings and activity

You need to set up the Transmission Verification Report and Journal Period in the menu table.

Press **Menu/Set, 2, 4, 1.**

1.Transmission

—OR—

Press **Menu/Set, 2, 4, 2.**

2.Journal Period

Customizing the Transmission Verification Report

You can use the Transmission Report as proof that you sent a fax. This report lists the time and date of transmission and whether the transmission was successful (OK). If you select **On** or **On+Image**, the report will print for every fax you send.

If you send a lot of faxes to the same place, you may need more than the job numbers to know which faxes you must send again. Selecting **On+Image** or **Off+Image** will print a section of the fax's first page on the report to help you remember.



When the Verification Report is turned **Off** or

Trans : Off+Image, the Report will only print if there is a transmission error, with **NG** in the **RESULT** column.

1 Press **Menu/Set, 2, 4, 1.**

1.Transmission

2 Press **▲** or **▼** to select **Off+Image**,
On, **On+Image** or **Off**.

Press **Menu/Set**.

3 Press **Stop/Exit**.

Setting the Journal Period

You can set the machine to print a journal at specific intervals (every 50 faxes, 6, 12 or 24 hours, 2 or 7 days). If you set the interval to *Off*, you can print the report by following the steps on the next page.

The default setting is *Every 50 Faxes*.

1 Press **Menu/Set, 2, 4, 2**.

2. Journal Period

2 Press **▲** or **▼** to choose an interval.

Press **Menu/Set**.

(If you choose 7 days, the LCD will ask you to choose a day on which to begin the 7-day countdown.)

3 Enter the time to begin printing in 24-hour format.

Press **Menu/Set**.

(For example: enter 19:45 for 7:45 PM.)

4 Press **Stop/Exit**.



If you select 6, 12, 24 hours, 2 or 7 days, the machine will print the report at the selected time and then erase all jobs from its memory. If the machine's memory becomes full with 200 jobs before the time you selected has passed, the machine will print the Journal early and then erase all jobs from memory. If you want an extra report before it is due to print, you can print it without erasing the jobs from memory.



If you select *Every 50 Faxes*, the machine will print the Journal when the machine has stored 50 jobs.

Printing reports

Following reports are available:

- | | |
|---------------|---|
| 1.Help List | Prints the Help List so you can see at-a-glance how to quickly program your machine. |
| 2.Quick-Dial | Lists names and numbers stored in the One-Touch and Speed-Dial memory, in numerical order. |
| 3.Fax Journal | Lists information about the last incoming and outgoing faxes.
(TX means Transmit.) (RX means Receive.) |
| 4.XMIT Verify | Prints a Transmission Verification Report for your last transmission. |

How to print a report

1 For MFC-3240C, press **Menu/Set**, **4**.

—OR—

For FAX-1840C, press **Ink Management/Reports** while holding down the **Shift** key.

2 Press **▲** or **▼** to select the report you want.

Press **Menu/Set**.

—OR—

Enter the number of the report you want to print.

For example, press **1** to print the Help List.



3 Press **Mono Start**.

8 Making copies

Using the machine as a copier

You can use your machine as a copier, making up to 99 copies at a time.

Enter Copy mode

Before making copies, make sure that  (**Copy**) is illuminated in green. If it is not, press  (**Copy**) to enter **Copy** mode. The default setting is Fax. You can change the number of seconds or minutes that the machine stays in Copy mode. (See *Setting the Mode Timer (FAX-1840C only)* on page 2-5 or *Setting the Mode Timer (MFC-3240C only)* on page 2-4.)

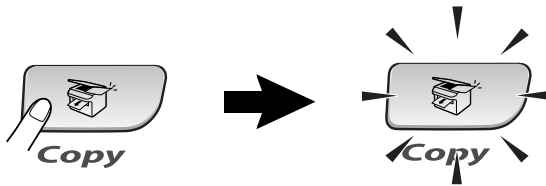

The LCD shows the default copy setting





The LCD display shows the default copy settings: 100% Normal 01

Copy Ratio

Quality

No of Copies

Making a single copy

- 1 Press  (**Copy**) to illuminate it in green.
 - 2 Load your document.
(See *Load documents* on page 1-7.)
 - 3 Press **Mono Start** or **Colour Start**.
-  To stop copying, press **Stop/Exit**.

Making multiple copies

- 1 Press  (**Copy**) to illuminate it in green.
- 2 Load your document.
- 3 Use the dial pad to enter the number of copies you want (up to 99).
- 4 Press **Mono Start** or **Colour Start**.

Stop copying



To stop copying, press **Stop/Exit**.

Using the temporary Copy keys (Temporary settings)

When you want to quickly change the copy settings temporarily for the next copy, use the temporary Copy keys. You can use different combinations.

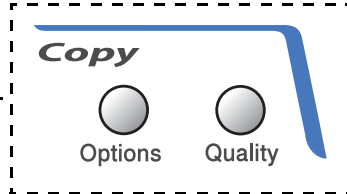
Temporary Copy Keys



-  These settings are temporary, and the machine returns to its default settings 60 seconds after it finishes copying. However if you have set the Mode Timer to 0 or 30 seconds, the machine returns to the default settings after the number of seconds that has been set for mode timer. (See *Setting the Mode Timer (FAX-1840C only)* on page 2-5 or *Setting the Mode Timer (MFC-3240C only)* on page 2-4.)
-  You can save the copy settings you use most often by setting them as default. (See *Changing the default copy settings* on page 8-12.)

Increasing copy speed or quality



You can select the copy quality. The default setting is *Normal*.

<p>Press Quality</p>  <p>Quality</p> <p>and ▲ or ▼</p>	<i>Normal</i>	Recommended mode for ordinary printouts. Good copy quality with adequate copy speed.
	<i>Fast</i>	Fast copy speed and lowest ink consumption. Use <i>Fast</i> to save time (document to be proof-read, large documents or many copies).
	<i>Best</i>	Use this mode to copy precise images such as photographs. <i>Best</i> uses the highest resolution and slowest speed.

- 1 Press  (**Copy**) to illuminate it in green.
- 2 Load your document.
- 3 Use the dial pad to enter the number of copies you want (up to 99).
- 4 Press **Quality**.
- 5 Press ▲ or ▼ to choose the copy quality (*Fast*, *Normal* or *Best*).
Press **Menu/Set**.
- 6 Press **Mono Start** or **Colour Start**.

Changing the temporary copy settings

Use the **Options** key to quickly set the following copy settings temporarily for the next copy.

Press Options 	Menu Selections  select	Options  select	Factory Setting	Page
	Enlarge/Reduce	50%/69%/78%/83%/93%/97%/100%/104%/142%/186%/198%/200%/Custom (25-400%)	100%	8-6
	Paper Type	Plain/Inkjet/Glossy/Transparency	Plain	8-8
	Paper Size	Letter/Legal/A4/A5/10 (W) x 15 (H) cm	A4	8-8
	Brightness	- ■■■■ +	- ■■■■ +	8-9
	Contrast	- ■■■■ +	- ■■■■ +	8-9
	Page Layout	Off (1 in 1)/2 in 1 (P)/2 in 1 (L)/4 in 1 (P)/4 in 1 (L)	Off (1 in 1)	8-12
	No. of Copies	No. of Copies:01 (01-99)	01	

After you choose your settings by pressing **Menu/Set**, the LCD shows *Set* temporarily.

Press **Mono Start** or **Colour Start** if you're finished choosing settings.

—OR—

Press ▲ or ▼ to select more settings.

Enlarging or reducing the image copied

You can select the following enlargement or reduction ratios.

Custom (25-400%) allows you to enter a ratio from 25% to 400%.

Press Options  Options and ▲ or ▼ to select Enlarge/Reduce	Custom (25-400%)
	200%
	198% 10x15cm→A4
	186% 10x15cm→LTR
	142% A5→A4
	104% EXE→LTR
	100%
	97% LTR→A4
	93% A4→LTR
	83% LGL→A4
	78% LGL→LTR
	69% A4→A5
	50%

- 1 Press  (**Copy**) to illuminate it in green.
- 2 Load your document.
- 3 Use the dial pad to enter the number of copies you want (up to 99).
- 4 Press **Options** and ▲ or ▼ to select `Enlarge/Reduce`.
Press **Menu/Set**.
- 5 Press ▲ or ▼ to select the enlargement or reduction ratio you want.

Press **Menu/Set**.

—OR—

You can select `Custom (25-400%)` and press **Menu/Set**.

Use the dial pad to enter an enlargement or reduction ratio from 25% to 400%.

Press **Menu/Set**.

(For example, press **5 3** to enter 53%.)

- 6 Press **Mono Start** or **Colour Start**.

 Special Copy Options 2 in 1 (P), 2 in 1 (L), 4 in 1 (P), 4 in 1 (L) or Poster are not available with Enlarge/Reduce.

Setting paper type

If you are copying on special paper, be sure to select the type of paper you are using so you will get the best print quality.

- 1 Press  (**Copy**) to illuminate it in green.
- 2 Load your document.
- 3 Use the dial pad to enter the number of copies you want (up to 99).
- 4 Press **Options** and ▲ or ▼ to select `Paper Type`.
Press **Menu/Set**.
- 5 Press ▲ or ▼ to select the type of paper you are using (`Plain`, `Inkjet`, `Glossy` or `Transparency`).
Press **Menu/Set**.
- 6 Press **Mono Start** or **Colour Start**.

 You can change the default Paper Type setting at any time.
(See *Setting the Paper Type* on page 2-6.)

Setting paper size

If copying on paper other than A4 size, you will need to change the paper size setting.

 You can copy on Letter, Legal, A4, A5 or Photo Card (10(W) x 15(H) cm) paper.

- 1 Press  (**Copy**) to illuminate it in green.
- 2 Load your document.
- 3 Use the dial pad to enter the number of copies you want (up to 99).
- 4 Press **Options** and ▲ or ▼ to select `Paper Size`.
Press **Menu/Set**.
- 5 Press ▲ or ▼ to select the size of paper you are using (`Letter`, `Legal`, `A4`, `A5` or `10 (W) x 15 (H) cm`).
Press **Menu/Set**.
- 6 Press **Mono Start** or **Colour Start**.

Adjusting brightness

You can adjust the copy brightness to make copies darker or lighter.

- 1 Press  (**Copy**) to illuminate it in green.
- 2 Load your document.
- 3 Use the dial pad to enter the number of copies you want (up to 99).
- 4 Press **Options** and ▲ or ▼ to select **Brightness**.
Press **Menu/Set**.
- 5 Press ▲ to make a lighter copy.
—OR—
Press ▼ to make a darker copy.
Press **Menu/Set**.
- 6 Press **Mono Start** or **Colour Start**.

Adjusting contrast

You can adjust the copy contrast to help an image look sharper and more vivid.

- 1 Press  (**Copy**) to illuminate it in green.
- 2 Load your document.
- 3 Use the dial pad to enter the number of copies you want (up to 99).
- 4 Press **Options** and ▲ or ▼ to select **Contrast**.
Press **Menu/Set**.
- 5 Press ▲ to increase the contrast.
—OR—
Press ▼ to decrease the contrast.
Press **Menu/Set**.
- 6 Press **Mono Start** or **Colour Start**.

Making N in 1 copies or a poster (Page Layout)

You can reduce the amount of copies by using the N in 1 copy feature. This allows you to copy two or four pages onto one page, which allows you to save paper.

-  ■ Please make sure Paper Size is set to **A4** or **Letter**.
- You can use N in 1 copy feature with 100% copy size only.
- (P) means Portrait and (L) means Landscape.

- 1** Press  (**Copy**) to illuminate it in green.
- 2** Load your document.
- 3** Use the dial pad to enter the number of copies you want (up to 99).
- 4** Press **Options** and ▲ or ▼ to select **Page Layout**.
Press **Menu/Set**.
- 5** Press ▲ or ▼ to select **2 in 1 (P)**, **2 in 1 (L)**, **4 in 1 (P)**, **4 in 1 (L)** or **Off(1 in 1)**.
Press **Menu/Set**.
- 6** Press **Mono Start** or **Colour Start** to scan the document.
- 7** The machine scans document and starts printing.

 If **Glossy** has been selected in the Paper Type setting for N in 1 copies, the machine will print the images as if Plain paper had been selected.

-  ■ If you are producing multiple colour copies, N in 1 copies are not available.
- N in 1 colour copies are not available for FAX-1840C and MFC-3240C.

Place document *face down* in the direction shown below.

2 in 1 (P)



2 in 1 (L)

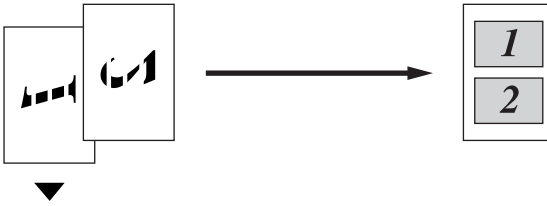

4 in 1 (P)

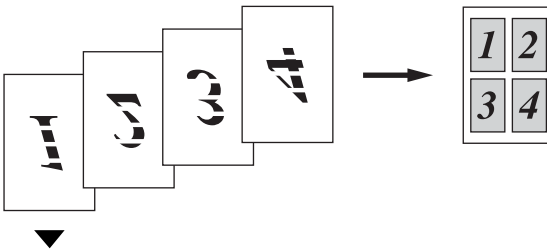

4 in 1 (L)

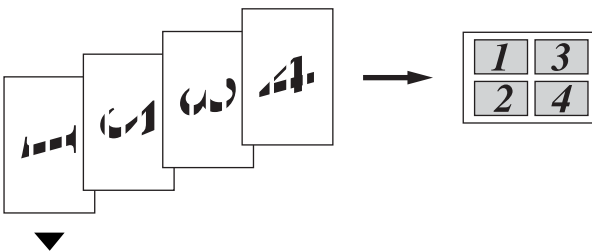

Changing the default copy settings

You can save the copy settings you use most often by setting them as default. These settings will remain until you change them again.

Increasing copy speed or quality

- 1 Press **Menu/Set**, **3**, **1**.
- 2 Press **▲** or **▼** to select **Normal**, **Best** or **Fast**.
Press **Menu/Set**.
- 3 Press **Stop/Exit**.

1.Quality

Adjusting brightness

- 1 Press **Menu/Set**, **3**, **2**.
- 2 Press **▲** to make a lighter copy.
—OR—
Press **▼** to make a darker copy.
Press **Menu/Set**.
- 3 Press **Stop/Exit**.

2.Brightness

Adjusting contrast

You can change the contrast to help an image look sharper and more vivid.

1 Press **Menu/Set**, **3**, **3**.

3.Contrast

2 Press **▲** to increase the contrast.

—OR—

Press **▼** to decrease the contrast.

Press **Menu/Set**.

3 Press **Stop/Exit**.

Adjusting colour saturation

1 Press **Menu/Set**, **3**, **4**.

4.Color Adjust

2 Press **▲** or **▼** to select Red, Green or Blue.

Press **Menu/Set**.

3 Press **▲** to increase the colour saturation.

—OR—

Press **▼** to decrease the colour saturation.

Press **Menu/Set**.

4 Return to Step 2 to select the next colour.

—OR—

Press **Stop/Exit**.

Legal limitations

Colour reproductions of certain documents are illegal and may result in either criminal or civil liability. This memorandum is intended to be a guide rather than a complete listing of every possible prohibition. In case of doubt, we suggest that you check with relevant authorities as to any particular questionable documents.

The following are examples of documents which should not be copied:

- Money
- Bonds or other certificates of debt
- Certificates of Deposit
- Service or Draft papers of the Armed Forces
- Passports
- Postage Stamps (cancelled or uncanceled)
- Immigration Papers
- Welfare documents
- Cheques or Drafts drawn by Governmental Agencies
- Documents, badges or insignias of identification
- Licences and Certificates of Title to motor vehicles

Works subject to Copyright cannot be copied. Sections of works subject to Copyright can be copied for 'fair use'. Multiple copies would indicate improper use.

Works of art should be considered as works subject to Copyright.

9 Important information

Important Information for Australia

IMPORTANT-For Your Safety.

To ensure safe operation the three-pin plug supplied must be inserted only into a standard three-pin power point which is effectively grounded through the normal household wiring.

Extension cords used with the equipment must be three-conductor and be correctly wired to provide connection to ground. Incorrectly wired extension cords are a major cause of fatalities.

The fact that the equipment operates satisfactorily does not imply that the power is grounded and that the installation is completely safe. For your safety, if in any doubt about the effective grounding of the power, consult a qualified electrician.

Disconnect device

This machine must be installed near a power outlet, which is easily accessible. In case of emergencies, you must disconnect the power cord from the power outlet in order to shut off power completely.

International ENERGY STAR® Compliance Statement

The purpose of the International ENERGY STAR® Program is to promote the development and popularization of energy-efficient office equipment.

As an ENERGY STAR® Partner, Brother Industries, Ltd. has determined that this product meets the ENERGY STAR® guidelines for energy efficiency.



Important safety instructions

- 1** Read all of these instructions.
- 2** Save them for later reference.
- 3** Follow all warnings and instructions marked on the product.
- 4** Unplug this product from the wall socket before cleaning. Do not use liquid or aerosol cleaners. Use a damp cloth for cleaning.
- 5** Do not use this product near water.
- 6** Do not place this product on an unstable cart, stand, or table. The product may fall, causing serious damage to the product.
- 7** Slots and openings in the cabinet and the back or bottom are provided for ventilation; to ensure reliable operation of the product and to protect it from overheating, these openings must not be blocked or covered. The openings should never be blocked by placing the product on a bed, sofa, rug, or other similar surface. This product should never be placed near or over a radiator or heater. This product should never be placed in a built-in installation unless proper ventilation is provided.
- 8** This product should be operated from the type of power source indicated on the label. If you are not sure of the type of power available, call your dealer or local power company.

- 9** This product is equipped with a 3-wire grounded plug, a plug having a third (grounded) pin. This plug will only fit into a grounded power outlet. This is a safety feature. If you are unable to insert the plug into the outlet, call your electrician to replace your obsolete outlet. Do not defeat the purpose of the grounded plug.
- 10** Do not allow anything to rest on the power cord. Do not place this product where people can walk on the cord.
- 11** Do not place anything in front of the machine that will block received faxes. Do not place anything in the path of received faxes.
- 12** Do not touch a document during printing.
- 13** Never push objects of any kind into this product through cabinet slots, since they may touch dangerous voltage points or short out parts resulting in a risk of fire or electric shock. Never spill liquid of any kind on the product.
- 14** Do not attempt to service this product yourself, because opening or removing covers may expose you to dangerous voltage points and/or other risks. Refer all servicing to service personnel.
- 15** Wait until pages have exited the machine before picking them up.
- 16** Unplug this product from the wall outlet and refer servicing to Authorized Service Personnel under the following conditions:
- When the power cord is damaged or frayed.
 - If liquid has been spilled into the product.
 - If the product has been exposed to rain or water.
 - If the product does not operate normally when the operating instructions are followed. Adjust only those controls that are covered by the operating instructions. Improper adjustment of other controls may result in damage and will often require extensive work by a qualified technician to restore the product to normal operation.
 - If the product has been dropped or the cabinet has been damaged.
 - If the product exhibits a distinct change in performance, indicating a need for service.

Important Information for New Zealand

Important Safety Instructions

- 1** Read all of these instructions.
- 2** Save them for later reference.
- 3** Follow all warnings and instructions marked on the product.
- 4** Unplug this product from the wall outlet before cleaning. Do not use liquid or aerosol cleaners. Use a damp cloth for cleaning.
- 5** The grant of a Telepermit for any item of terminal equipment indicates only that Telecom has accepted that the item complies with minimum conditions for connection to its network. It indicates no endorsement of the product by Telecom, nor does it provide any sort of warranty. Above all, it provides no assurance that any item will work correctly in all respects with another item of Telepermitted equipment of a different make or model, nor does it imply that any product is compatible with all of Telecom's network services.
- 6** This equipment does not fully meet Telecom's impedance requirements. Performance limitations may occur when used in conjunction with some parts of the network. Telecom will accept no responsibility should difficulties arise in such circumstances.
- 7** If a charge for local calls is acceptable, the "Dial Button" should not be used for local calls. Only the 7-digits of the local number should be dialled from your telephone. Do not dial the area code digit or the "0" prefix.
- 8** This equipment shall not be set to make automatic calls to the Telecom '111' Emergency Service.
- 9** This equipment should not be used under any circumstances which may constitute a nuisance to other Telecom customers.
- 10** Not all telephones will respond to incoming ringing when connected to the extension socket.
- 11** The answer delay setting of this equipment shall not be set to less than the default setting as this will destroy Caller ID information.

- 12** All persons using this device for recording telephone conversations shall comply with New Zealand law. This requires that at least one party to the conversation is to be aware that it is being recorded. In addition, the Principles enumerated in the Privacy Act 1993 shall be complied with in respect to the nature of the personal information collected, the purpose for its collection, how it is to be used and what it disclosed to any other party.
- 13** Do not place this product on an unstable surface, stand, or table. The product may fall, causing serious damage to the product.
- 14** Slots and openings in the cabinet and the back or bottom are provided for ventilation; to ensure reliable operation of the product and to protect it from overheating, these openings must not be blocked or covered. The openings should never be blocked by placing the product on a bed, sofa, rug, or other similar surface. This product should never be placed near or over a radiator or heater. This product should not be placed in a built-in installation unless proper ventilation is provided.
- 15** This product should be operated from the type of power source indicated on the label. If you are not sure of the type of power available, consult with your dealer or local power company.
- 16** This product is equipped with a 3-wire earthed plug. This plug will fit into only an earthed socket. This is a safety feature. If you are unable to insert the plug into the outlet, contact your electrician to replace your obsolete socket. Do not defeat the purpose of an earthed plug.
- 17** Do not allow anything to rest on the power cord. Do not locate this product where people can walk on the cord.
- 18** Do not place anything in front of the machine that will block received faxes. Do not place anything in the path of received faxes.
- 19** Do not touch a document during printing.
- 20** Never push objects of any kind into this product through cabinet slots, since they may touch dangerous voltage points or short out parts resulting in a risk of fire or electric shock. Never spill liquid of any kind on the product.

- 21** Do not attempt to service this product yourself, because opening or removing covers may expose you to dangerous voltage points and/or other risks. Refer all servicing to service personnel.
- 22** Unplug this product from the mains power and telephone line sockets, and refer servicing to qualified Service Personnel under the following conditions:
- If the power cord is damaged or frayed.
 - If liquid has been spilled into the product.
 - If the product has been exposed to rain or water.
 - If the product does not operate normally when the operating instructions are followed. Adjust only those controls that are covered by the operating instructions. Improper adjustment of other controls may result in damage and will often require extensive work by a qualified technician to restore the product to normal operation.
 - If the product has been dropped or the cabinet has been damaged.
 - If the product exhibits a distinct change in performance, indicating a need for service.
- 23** This unit will only work in conjunction with a tone signalling (DTMF) telephone, but some telephones are not compatible. Since noise or speech from the telephone can upset dialling from this unit, errors may result if the devices are used together in other than quiet conditions.
- 24** Where it is necessary to dial prefix digits, such as a Caller Display override code (“0196” or “0197”), this unit will have to be used in conjunction with an associated tone signalling (DTMF) telephone.
- 25** Note that some telephones are not compatible with this unit and dialling errors may result if the two devices are used together in other than quiet conditions. The Telecom Faults Service is not to be called should such problems arise. In such cases, it is recommended that the prefix and wanted number are dialled manually.
- 26** This equipment may not provide for the effective hand-over of a call to another device connected to the same line.

IMPORTANT-For Your Safety

To ensure safe operation the three-pin plug supplied must be inserted only into a standard three-pin power point which is effectively grounded through the normal household wiring.

Extension cords used with the equipment must be three-conductor and be correctly wired to provide connection to ground. Incorrectly wired extension cords are a major cause of fatalities.

The fact that the equipment operates satisfactorily does not imply that the power is grounded and that the installation is completely safe. For your safety, if in any doubt about the effective grounding of the power, consult a qualified electrician.

Disconnect device

This machine must be installed near a power outlet, which is easily accessible. In case of emergencies, you must disconnect the power cord from the power outlet in order to shut off power completely.

IMPORTANT NOTICE

Under power failure conditions, this telephone may not operate. Please ensure that a separate telephone, not dependent on local power, is available for emergency use in emergencies.

Important Information for Some Countries

Important Safety Instructions

- 1** Read all of these instructions.
- 2** Save them for later reference.
- 3** Follow all warnings and instructions marked on the product.
- 4** Unplug this product from the wall outlet before cleaning. Do not use liquid or aerosol cleaners. Use a damp cloth for cleaning.
- 5** Do not place this product near water.
- 6** Do not place this product on an unstable cart, stand, or table. The product may drop, causing serious damage to the product.
- 7** Slots and openings in the cabinet and the back or bottom are provided for ventilation; to ensure reliable operation of the product and to protect it from overheating, these openings must not be blocked or covered. The openings should never be blocked by placing the product on a bed, sofa, rug, or other similar surface. This product should never be placed near or on a radiator or heater. This product should never be placed in a built-in installation unless proper ventilation is provided.
- 8** This product should be operated from the type of power source indicated on the label. If you are not sure of the type of power available, consult with your dealer or local power company.
- 9** This product is equipped with a 2-wire grounding type plug or a 3-wire grounding type plug (Only for Singapore, Malaysia, Hong Kong and India), a plug having two or three pins. This plug will only fit into only a grounding-type power outlet. This is a safety feature. If you are unable to insert the plug into the outlet, contact your electrician to replace your obsolete outlet. Do not defeat the purpose of the grounding-type plug.
- 10** Do not allow anything to rest on the power cord. Do not place this product where people can walk on the cord.

- 11** If an extension cord is used with this product, make sure that the total ampere ratings on the products plugged into the extension cord do not exceed the extension cord ampere rating.
- 12** Do not place anything in front of the machine that will block received faxes. Do not place anything in the path of received faxes.
- 13** Do not touch a document during printing.
- 14** Never push objects of any kind into this product through cabinet slots, since they may touch dangerous voltage points or short out parts resulting in the risk of fire or electric shock. Never spill liquid of any kind on the product.
- 15** Do not attempt to service this product yourself, as opening or removing covers may expose you to dangerous voltage points and/or other risks, and may void your warranty. Please refer all servicing to our Authorized Service Personnel. A list of Authorized Service Centres has been included for your convenience, or you may contact the Brother Dealer for Service.
- 16** Unplug this product from the wall outlet and refer servicing to Authorized Service Personnel under the following conditions:
 - If the power cord is damaged or frayed.
 - If the product has been spilled by liquid.
 - If the product has been exposed to rain or water.
 - If the product does not operate normally when the operating instructions are followed. Adjust only those controls that are covered by the operating instructions. Improper adjustment of other controls may result in damage and will often require extensive work by a qualified technician to restore the product to normal operation.
 - If the product has been dropped or the cabinet has been damaged.
 - If the product exhibits a distinct change in performance, indicating a need for service.

17 To protect your product against power surges, we recommend the use of a power protection device (Surge Protector).



For protection against the risk of electrical shock, always disconnect all cables from the wall outlet before servicing, modifying or installing the equipment.

This equipment may not be used on coin service lines provided by the telephone company or connected to party lines.

Brother cannot accept any financial or other responsibilities that may be the result of your use of this information, including direct, special or consequential damages. There are no warranties extended or granted by this document.

Trademarks

The Brother logo is a registered trademark of Brother Industries, Ltd.

Brother is a registered trademark of Brother Industries, Ltd.

Multi-Function Link is a registered trademark of Brother International Corporation.

© 2004 Brother Industries, Ltd. All rights reserved.

Windows and Microsoft are registered trademarks of Microsoft in the U.S. and other countries.

Macintosh and TrueType are registered trademarks of Apple Computer, Inc.

PaperPort and OmniPage OCR are registered trademarks of ScanSoft, Inc.

Presto! PageManager is a registered trademark of NewSoft Technology Corporation.

Microdrive is a trademark of International Business Machine Corporation.

SmartMedia is a registered trademark of Toshiba Corporation.

CompactFlash is a registered trademark of SanDisk Corporation.

Memory Stick is a registered trademark of Sony Corporation.

SecureDigital is a trademark of Matsushita Electric Industrial Co. Ltd., SanDisk Corporation and Toshiba Corporation.

SanDisk is a licensee of the SD and miniSD trademarks.

xD-Picture Card is a trademark of Fujifilm Co. Ltd., Toshiba Corporation and Olympus Optical Co. Ltd.

Memory Stick Duo and MagicGate are trademarks of Sony Corporation.

Each company whose software title is mentioned in this manual has a Software License Agreement specific to its proprietary programs.

All other brand and product names mentioned in this User's Guide, the Software User's Guide (MFC-3240C) are registered trademarks of their respective companies.

10 Troubleshooting and routine maintenance

Troubleshooting

Error messages

As with any sophisticated office product, errors may occur. If this happens, your machine identifies the problem and displays an error message. The most common error messages are shown below.

You can correct most problems by yourself. If you need additional help, the Brother Solutions Center offers latest FAQs and troubleshooting tips.

Visit us at <http://solutions.brother.com>.

ERROR MESSAGES		
ERROR MESSAGE	CAUSE	ACTION
Comm. Error	Poor phone line quality caused a communication error.	Try the call again. If the problem continues, call the telephone company and ask them to check your phone line.
Connection Fail	You tried to poll a fax machine that is not in Polled Waiting mode.	Check the other fax machine's polling setup.
Cover is Open	Top cover is not closed completely.	Open, then close the top cover.
Data Remaining	Print data remains in the machine's memory.	Re-start printing from your computer.
	Print data remains in the machine's memory. The USB cable was unplugged while the computer was sending the data to the machine.	Press Stop/Exit . The machine will cancel the job and eject the page that is being printed.
Disconnected	The other person or other person's fax machine stopped the call.	Try to send or receive again.
Document Jam	The document scanned from ADF was longer than about 90 cm.	See <i>Using the automatic document feeder (ADF)</i> on page 1-7.
	The document is jammed in the machine.	See <i>Document Jam</i> on page 10-4

ERROR MESSAGES		
ERROR MESSAGE	CAUSE	ACTION
High Temperature	The print head is too warm.	Allow the machine to cool down.
Ink Empty	One or more of the ink cartridges is empty. The machine will stop all print operations. While memory is available, black and white faxes will be received into memory. If a sending machine has a colour fax, the machine's 'handshake' will request that the fax be sent as black and white. If the sending machine has the ability to convert it, the colour fax will be received into memory as a black and white fax.	Replace the ink cartridges. (See <i>Replacing the ink cartridges</i> on page 10-23.)
Low Temperature	The print head is too cold.	Allow the machine to warm up.
Near Empty	One or more of the ink cartridges are running out of ink. If a sending machine has a colour fax, the machine's 'handshake' will request that the fax be sent as black and white. If the sending machine has the ability to convert it, the colour fax will be received into memory as a black and white fax.	Order a new ink cartridge. (See <i>Replacing the ink cartridges</i> on page 10-23.)
No Cartridge	An ink cartridge is not properly installed.	Take out the ink cartridge and put it in again seating it properly. (See <i>Replacing the ink cartridges</i> on page 10-23.)
No Paper Fed	The machine is out of paper.	Add paper, and then press Mono Start or Colour Start .
	The paper is jammed in the machine.	See <i>Printer jam or paper jam</i> on page 10-5.
No Response/Busy	The number you dialled does not answer or is busy.	Verify the number and try again.
Not Registered	You tried to access a One-Touch or Speed-Dial number that is not programmed.	Set up the One-Touch or Speed-Dial number. (See <i>Storing One-Touch Dial numbers</i> on page 5-1 and <i>Storing Speed-Dial numbers</i> on page 5-2.)

ERROR MESSAGES		
ERROR MESSAGE	CAUSE	ACTION
Out of Memory	The machine's memory is full.	(Fax sending or copy operation in process) Press Stop/Exit and wait until the other operations in progress finish and then try again. —OR— Clear the data in the memory. To gain extra memory, you can turn off Fax Storage. (See <i>Setting Fax Storage</i> on page 6-2.) —OR— Print the faxes that are in the memory. (See <i>Printing a fax from the memory</i> on page 4-7.) (Printing operation in process) Reduce print resolution.
Paper Jam	Paper is jammed in the machine.	(See <i>Printer jam or paper jam</i> on page 10-5.)
Unable to Change Unable to Clean Unable to Init. Unable to Print Unable to Scan	The machine has a mechanical problem. —OR— A foreign obstacle, such as a clip or ripped paper, is in the machine.	Close the document support and the document tray. Open the top cover and remove any foreign obstacles from inside the machine. If the error message continues, please follow the steps below before disconnecting the machine so you will not lose any important messages. Then, disconnect the machine from the power source for several minutes (which will erase all faxes), and then reconnect it. Check whether the machine has faxes in the memory 1. Press Menu/Set, 9, 0, 1 . 2. If the machine has no faxes, disconnect the machine from the power source for several minutes, and then reconnect it. —OR— If faxes are present, you can transfer them to another fax machine. Go to Step 3. Transfer faxes to another fax machine If you have not set up your Station ID, you cannot enter fax transfer mode. 3. Enter the fax number to which faxes will be forwarded. 4. Press Mono Start . 5. After the faxes are transferred, disconnect the machine from the power source for several minutes, and then reconnect it. You can transfer the Fax Journal report to another fax machine by pressing Menu/Set, 9, 0, 2 in Step1.
Wrong Paper Size	Paper is not the correct size.	Reload the correct size of paper (Letter, Legal or A4), and then press Mono Start or Colour Start .

Document Jam

If the document is jammed, follow the steps below.

Document is jammed inside the front of the machine.

- 1** Remove any paper from the ADF that is not jammed.
- 2** Pull the jammed document out toward the front of the machine.

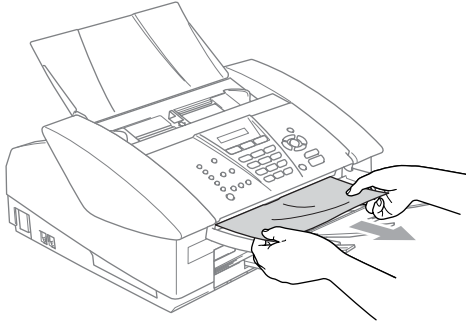

- 3** Press **Stop/Exit**.

Printer jam or paper jam

Remove the jammed paper depending on where it is jammed in the machine.

Paper is jammed inside the paper tray

- 1 Pull the paper tray out of the machine.

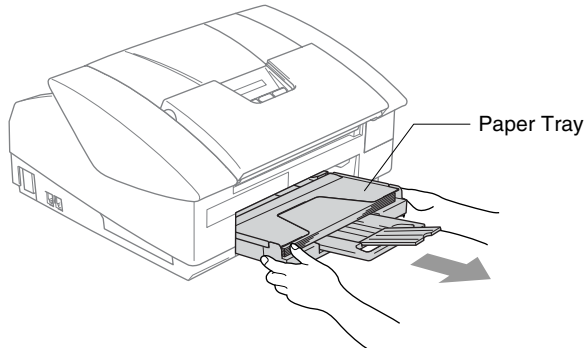

- 2 Slowly pull out the jammed paper to remove it.

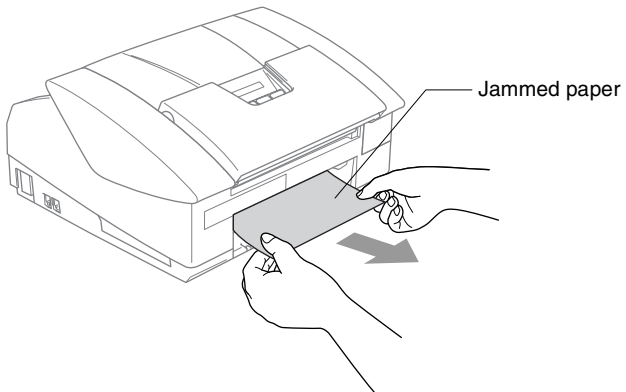

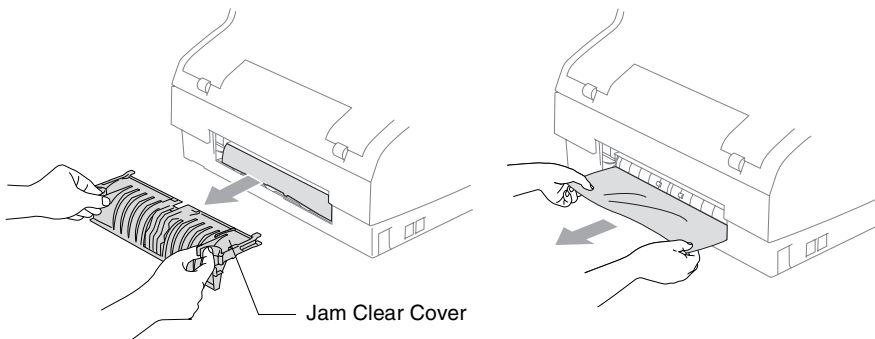

Paper is jammed inside the machine

- 1 Remove the jam clear cover. Pull the jammed paper out of the machine.

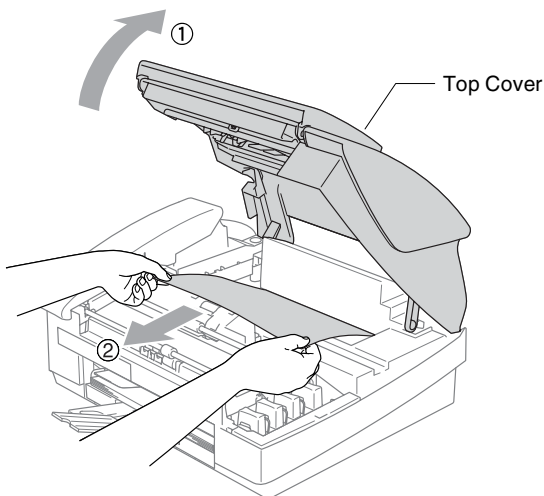

- 2 Re-insert the jam clear cover.
- 3 If you can not pull out the jammed paper, close the document support and the document tray and lift the open cover to the open position until it locks securely into place.
- 4 Remove the jammed paper.



-  If the paper is jammed underneath the print head, disconnect the machine from the power source so you can move the print head to take out the paper.

5 Close the top cover.

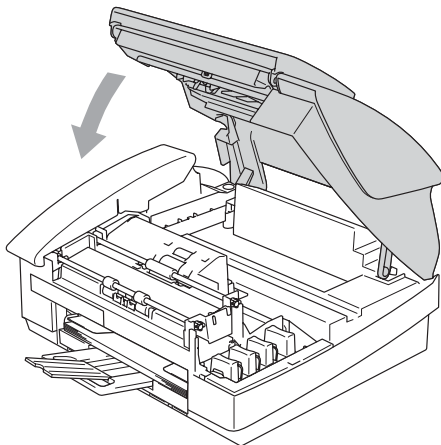

If you are having difficulty with your machine

If you think there is a problem with your machine, check the chart below and follow the troubleshooting tips.

The Brother Solutions Center offers the latest FAQs and troubleshooting tips.

Visit us at <http://solutions.brother.com>.

DIFFICULTY	SUGGESTIONS
Printing	
No printout	Check the interface cable connection on both the machine and your computer.
	Check the machine is plugged in and not in the Power Save condition.
	One or more ink cartridges are empty. (See <i>Replacing the ink cartridges</i> on page 10-23.)
	Check to see if the LCD is showing an error message. (See <i>Error messages</i> on page 10-1.)
Poor quality print.	Check the print quality. (See <i>Checking the print quality</i> on page 10-14.)
	Make sure the Printer Driver or Paper Type setting in the menu matches the type of paper you are using. (See <i>Media Type</i> on page 1-8 in Software User's Guide on the CD-ROM and <i>Setting the Paper Type</i> on page 2-6.)
	Make sure your ink cartridges are fresh. Cartridges remain fresh for up to two years if kept in their original packaging, after that the ink may become clogged. Cartridge expiration dates are printed on the package.
	Try using the recommended types of paper. (See <i>About paper</i> on page 1-9.)
	The recommended environment for your machine is between 20°C to 33°C.
White horizontal lines appear in text or graphics.	Clean the print head. (See <i>Cleaning the print head</i> on page 10-13.)
	Try using the recommended types of paper. (See <i>About paper</i> on page 1-9.)
	If horizontal bands appear when using plain paper, use the 'Enhanced Normal Printing' mode to help avoid banding on some types of plain paper. In the printer driver 'Basic' tab, click 'Settings', and check 'Enhanced Normal Printing'. If you continue to have horizontal bands, change the Media Type selection to 'Slow Drying Paper' in the printer driver 'Basic' tab to help enhance the print quality.
The machine prints blank pages.	Clean the print head. (See <i>Cleaning the print head</i> on page 10-13.)
Characters and lines are stacked.	Check the printing alignment. (See <i>Checking the printing alignment</i> on page 10-16.)
Printed text or images are skewed.	Make sure the paper is loaded properly in the paper tray and the paper side guide is adjusted correctly. (See <i>How to load paper, envelopes and post cards</i> on page 1-14.)

DIFFICULTY	SUGGESTIONS
Printing (Continued)	
Smudged stain at the top center of the printed page.	Make sure the paper is not too thick or not curled. (See <i>About paper</i> on page 1-9.)
Printing appears dirty or ink seems to run.	Make sure you are using the proper types of paper. (See <i>About paper</i> on page 1-9.) Don't handle the paper until the ink is dry.
Stains appear on the reverse side or at the bottom of the page.	Make sure the Printer Platen is not dirty with ink. (See <i>Cleaning the machine Printer Platen</i> on page 10-22.)
	Make sure you are using the paper support flap. (See <i>How to load paper, envelopes and post cards</i> on page 1-14.)
There are some dense lines.	Check 'Reverse Order' in the Basic tab of the printer driver.
The printouts are wrinkled.	In the printer driver 'Basic' tab, click the 'Settings', and uncheck the 'Bi-Directional Printing'.
Cannot perform '2 in 1 or 4 in 1' printing.	Check that the paper size setting in the application and in the printer driver are the same.
Print speed is too slow.	Changing the printer driver setting may improve the print speed. Highest resolution needs longer data processing, transfer and printing time. Try the other settings of quality in the printer driver 'Basic' tab. Also, click the 'Settings' tab, and make sure you uncheck the Colour Enhancement.
	Borderless printing is slower than normal printing. If you want to print more quickly, set the Borderless feature off. (See <i>Media Type</i> on page 1-8 in Software User's Guide on the CD-ROM.)
Colour Enhancement is not working properly.	If the image data is not full colour in your application (Such as 256 colour), Colour Enhancement will not work. Please use at least 24 bit colour data with the Colour Enhancement feature.
Machine feeds multiple pages	Make sure the paper is loaded properly in the paper tray. (See <i>How to load paper, envelopes and post cards</i> on page 1-14.)
	Check that more than two types of paper are not loaded in the paper tray at any one time.
Printed pages are not stacked neatly.	Make sure you are using the paper support flap. (See <i>How to load paper, envelopes and post cards</i> on page 1-14.)
Machine does not print from Paint Brush.	Try setting the Display setting to '256 colours.'
Machine does not print from Adobe Illustrator.	Try to reduce the print resolution.
Printing Received Faxes	
Condensed print and white streaks across the page or the top and bottom of sentences are cut off.	This can be caused by static or interference on the telephone line. You can make a copy using the Mono Start key to see if the same problem occurs. If the copy looks good then the problem is probably the phone line and not your machine.
Vertical black lines when receiving.	The sender's scanner may be dirty. Ask the sender to make a copy to see if the problem is with the sending machine. Try receiving from another fax machine.

DIFFICULTY	SUGGESTIONS
Printing Received Faxes (Continued)	
Received colour fax prints only in black and white.	Replace the colour ink cartridges that are empty or nearly empty, and then ask the other person to send the colour fax again. (See <i>Replacing the ink cartridges</i> on page 10-23.) Check that Fax Storage is set to OFF. (See <i>Setting Fax Storage</i> on page 6-2.)
Left and Right margins are cut off or a single page is printed on two pages.	Turn on Auto Reduction. (See <i>Printing a reduced incoming fax (Auto Reduction)</i> on page 4-6.)
Phone Line or Connections	
Dialling does not work. (No dial tone)	Check the machine is plugged in.
	Check for a dial tone. If possible, call your machine to hear it answer. If there is still no answer, check the telephone line cord connection and make sure all telephone connections are secured. If there is no ringing when you call your machine, ask your telephone company to check the line.
	Change Tone/Pulse setting. (See <i>Setting Tone or Pulse dialling mode (Not available in New Zealand)</i> on page 2-1.)
Receiving Faxes	
Cannot receive a fax	Make sure the machine is in the correct receiving mode for your setup. (See <i>Basic receiving operations</i> on page 4-1.)
	If you frequently encounter interference on the phone line, try changing the menu setting of Compatibility to Basic . (See <i>Compatibility</i> on page 10-12.)
	If you connect your machine to PBX, PABX or ADSL, set the menu setting of Phone Line Type to your phone type. (See <i>Setting Tone or Pulse dialling mode (Not available in New Zealand)</i> on page 2-1.)
Sending Faxes	
Cannot send a fax	Make sure that the Fax  key is illuminated. (See <i>How to enter Fax mode</i> on page 3-1.)
	Ask the other party to check that receiving machine has paper.
	Print the Transmission Verification Report and check for an error. (See <i>Printing reports</i> on page 7-3.)
Transmission Verification Report says 'Result:NG' or 'Result:ERROR'.	There is probably temporary noise or static on the line. Try sending the fax again. If you send a PC FAX message and get 'Result:NG' on the Transmission Verification Report, your machine may be out of memory.
	If you frequently get transmission error with possible interference on the phone line, try to change the menu setting of Compatibility to Basic . (See <i>Compatibility</i> on page 10-12.)
	If you connect your machine to PBX, PABX or ADSL, set the menu setting of Phone Line Type to your phone type. (See <i>Setting Tone or Pulse dialling mode (Not available in New Zealand)</i> on page 2-1.)
Poor sending quality.	Try changing your resolution to Fine or S.Fine . Make a copy to check your machine's scanner operation.
Vertical black lines when sending.	If the copy you made shows the same problem, your scanner is dirty. (See <i>Routine maintenance</i> on page 10-21.)

DIFFICULTY	SUGGESTIONS
Handling Incoming Calls	
The machine 'Hears' Voice as CNG Tone.	If your machine is set to Fax Detect ON, it is more sensitive to sounds. Your machine may mistakenly interpret certain voices or music on the line as a calling fax machine and respond with fax receiving tones. Deactivate the fax by pressing Stop/Exit . Try avoiding this problem by turning Fax Detect to Off. (See <i>Fax Detect (MFC-3240C only)</i> on page 4-4 and <i>Fax Detect (FAX-1840C only)</i> on page 4-5.)
Transferring a Fax Call to the machine.	If you answered at the machine, press Mono Start and hang up immediately. If you answered on an external or extension phone, press your Fax Receive Code (default setting is (✕)51). When your machine answers, hang up.
Custom features on a single line.	If you have Call Waiting, Call Waiting/Caller ID, an alarm system or any other custom feature on a single phone line with your machine, it may create a problem sending or receiving faxes. For example: If you are sending or receiving a fax message while a custom feature signal comes through on the line, the signal can temporarily interrupt or disrupt the faxes. Brother's ECM feature should help overcome this problem. This condition is related to the telephone system industry and is common to all devices that send and receive data on a single, shared line with custom features. If avoiding a slight interruption is crucial to your business, we recommend a separate phone line with no custom features.
Copying Difficulties	
Cannot make a copy	Make sure that the Copy  key is illuminated. (See <i>Enter Copy mode</i> on page 8-1.)
Vertical streaks appear in copies	Sometimes you may see vertical streaks on copies. Clean the scanner. (See <i>Cleaning the Scanner</i> on page 10-21.)
Scanning Difficulties (MFC-3240C only)	
TWAIN/WIA errors appear while scanning.	Make sure the Brother TWAIN/WIA driver is selected as the primary source. In PaperPort®, click Scan in the File menu and select the Brother TWAIN/WIA driver.
Software Difficulties (MFC-3240C only)	
Cannot install software or print	Run the MFL-Pro Suite Repair and Install program on the CD-ROM. This program will repair and reinstall the software.
'Device Busy'	Make sure the machine is not showing an error message on the LCD.
'Connect Failure'	If the machine is not connected to your PC and you have loaded the Brother software, the PC will show 'machine Connect Failure' each time you restart Windows®. You can ignore this message or you can turn it off as follows. Double-click "tool\warnOff.REG" from the supplied CD-ROM. To turn it back on, double-click "tool\WarnOn.REG" from the supplied CD-ROM. The Scan key on the machine's control panel will not work unless you restart your PC with the machine connected.

Compatibility

If you are having difficulty sending or receiving a fax due to possible interference on the phone line, we recommend that you adjust the Equalization for compatibility. The machine adjusts the modem speed for fax operations.

1 Press **Menu/Set, 2, 0, 2**.

2.Compatibility

2 Press **▲** or **▼** to select **Basic**, (or **Normal**).



For MFC-3240C, you can select **High** to return to 33600 bps.

Press **Menu/Set**.

3 Press **Stop/Exit**.



■ **Basic** reduces the modem speed to 9600 bps. Unless there is a lot of interference on your phone line, you may prefer to use it only when needed.

■ **Normal** sets the modem speed at 14400 bps.

How to improve print quality

Cleaning the print head

To ensure good print quality, the machine will regularly clean the print head. You can start the cleaning process manually if needed.

Clean the print head and ink cartridges if you get a horizontal line in the text or graphics on your printed pages. You can clean Black only or three colours at a time (Cyan/Yellow/Magenta), or all four colours at once.

Cleaning the print head consumes ink. Cleaning too often uses ink unnecessarily.

Caution

Do NOT touch the print head. Touching the print head may cause permanent damage and may void the print head's warranty.

- 1** Press **Ink Management**.
- 2** Press **▲** or **▼** to select **Cleaning**.
Press **Menu/Set**.
- 3** Press **▲** or **▼** to select **Black, Color** or **All**.
Press **Menu/Set**.

The machine will clean the print head. When cleaning is finished, the machine will go back to standby mode automatically.



- If you clean the print head at least five times and the print has not improved, call your Brother dealer for service.
- The print head controls the flow of ink using tiny pumps to produce characters or images onto the page.
- We recommend having the machine powered up at all times. The periodical cleaning is performed to prevent the drying up of the ink in the head nozzles and is achieved by purging ink from the print head. This process is performed automatically, on average, every two days dependant on room temperature. The machine is set so that this process occurs in the early hours of the morning.
- When the cleaning process is finished, the machine will automatically return to its previous state.

Checking the print quality

If faded or streaked colours and text appears on your output, some of the nozzles may be clogged. You can check this by printing the Print Quality Check Sheet and looking at the nozzle check pattern.

- 1 Press **Ink Management**.
- 2 Press ▲ or ▼ to select `Test Print`.
Press **Menu/Set**.
- 3 Press ▲ or ▼ to select `Print Quality`.
Press **Menu/Set**.
- 4 Press **Colour Start**.

The machine begins printing the Print Quality Check Sheet.

- 5 Check the sheet to see if the quality is OK by following these steps:

Colour block quality check

The LCD shows:

Is Quality OK?

1.Yes 2.No

- 6 Check the quality of the four colour blocks on the sheet.
- 7 If all lines are clear and visible, press **1** (Yes), and go to Step 10.
—OR—

If you can see missing short lines as shown below, press **2** (No).

OK

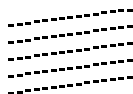

Poor



The LCD will ask you if the print quality is OK for black and three colours.

Black OK?

1.Yes 2.No

- 8** Press **2** (No) for black or three colours with a problem.

Start Cleaning?

The LCD shows:

1.Yes 2.No

Press **1** (Yes).

The machine will start cleaning the print head.

- 9** After cleaning is finished, press **Colour Start**. The machine will start printing the Print Quality Check Sheet again and then return to step 5.

- 10** Press **Stop/Exit**.

If you still see missing ink in this Print Quality Check Sheet, repeat the cleaning and test print procedures at least five times. If ink is still missing after the fifth cleaning and test print, replace the ink cartridge for the clogged colour. (Perhaps the ink cartridge was in your machine over six months or the expiration date written on the cartridge package has passed. Or, the ink may not have been stored properly before use.)

After replacing the ink cartridge, check it by printing another Print Quality Check Sheet. If the problem still exists, repeat the cleaning and test print procedures at least five times for the new ink cartridge. If ink is still missing, call your Brother dealer.

! Caution

Do NOT touch the print head. Touching the print head may cause permanent damage and may void the print head's warranty.



When a print head nozzle is clogged the printed sample looks like this.



After the print head nozzle is cleaned, the horizontal lines are gone.

Checking the printing alignment

You should rarely need to adjust the printing alignment however, if after transporting the machine your printed text becomes blurred or images become faded then adjustment may need to be made.

- 1 Press **Ink Management**.
- 2 Press ▲ or ▼ to select `Test Print`.
Press **Menu/Set**.
- 3 Press ▲ or ▼ to select `Alignment`.
Press **Menu/Set**.
- 4 Press **Mono Start** or **Colour Start**.

The machine begins printing the Alignment Check Sheet.

The LCD shows:

`Is Alignment OK?`

`1.Yes 2.No`

- 5 Check the 600 dpi and 1200 dpi test prints to see if number 5 most closely matches number 0. If the number 5 sample of both the 600 dpi and 1200 dpi are the best matches, press **1** (**Yes**) to finish Alignment Check, and go to Step 8.

—OR—

If another test print number is a better match for either 600 dpi or 1200 dpi, press **2** (**No**) to select it.

- 6 For 600 dpi, press the number of the test print that most closely matches the number 0 sample (1-8).

`600dpi Adjust`

`Select Best # 5`

- 7 For 1200 dpi, press the number of the test print that most closely matches the number 0 sample (1-8).

`1200dpi Adjust`

`Select Best # 5`

- 8 Press **Stop/Exit**.

Checking the ink volume

You can check the ink that is left in the cartridge.

- 1 Press **Ink Management**.
- 2 Press **▲** or **▼** to select **Ink Volume**.
Press **Menu/Set**.

- 3 Press **▲** or **▼** to select the colour you want to check.

Ink Volume

The LCD shows the ink volume.

Bk: -□□□■□□□+ ◆

- 4 Press **Stop/Exit**.



(MFC-3240C only) You can check the ink volume from your computer. (See *MFC Remote Setup* (not available for *DCP-110C*, *DCP-310CN* and *MFC-210C*) on page 4-1 in Software User's Guide on the CD-ROM or *MFC Remote Setup* (Mac OS® X 10.2.4 or greater) (not available for *DCP-110C*, *DCP-310CN* and *MFC-210C*) on page 8-43 in Software User's Guide on the CD-ROM.)

Packing and shipping the machine

Whenever you transport the machine, use the packing materials that came with your machine. If you do not pack the machine properly, you could void your warranty.

! Caution

It is important to allow the machine to ‘park’ the print head after a print job. Listen carefully to the machine before disconnecting it from the power source to ensure that all mechanical noise has stopped. Not allowing the machine to complete this parking process may lead to print problems and possible damage to the print head.

- 1 Close the document support and the document tray.
- 2 Lift the top cover to the open position until it locks securely into place.
- 3 Remove all the ink cartridges and attach the protective parts.
(See *Replacing the ink cartridges* on page 10-23.)

When attaching the protective parts, make sure it clips into place as shown in the diagram.

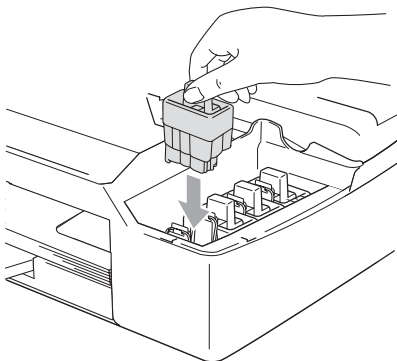

! Caution

If you are not able to find the protective parts, do NOT remove the ink cartridges before shipping. It is essential that the machine be shipped with either the protective parts or the ink cartridges in position. Shipping without them will cause damage to your machine and may void your warranty.

- 4** Close the top cover.
- 5** Unplug the machine from the telephone wall socket and remove the telephone line cord from machine.
- 6** Unplug the machine from the electrical socket.
- 7** Unplug the USB cable or LAN cable from the machine, if it is connected.
- 8** If your machine has a handset, remove it and the handset curled cord.
- 9** Wrap the machine in the bag and place it in the original carton with the original packing material.

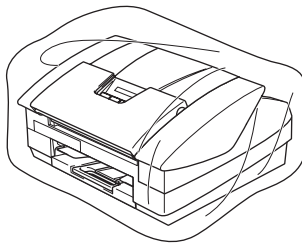

10 Pack the printed materials in the original carton as shown below.
Do not pack the used ink cartridges in the carton.

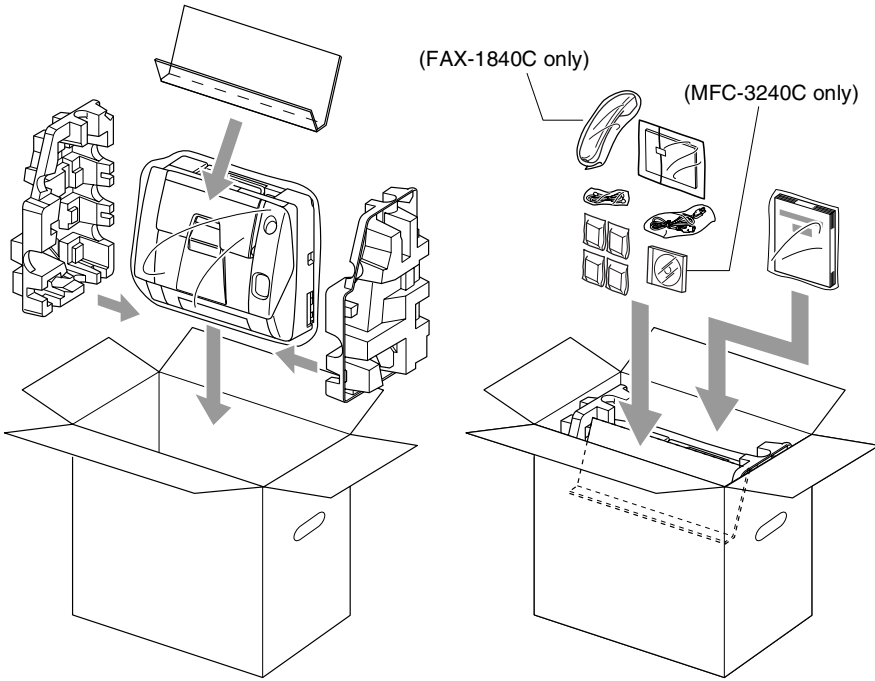

11 Close the carton.

Routine maintenance

Cleaning the Scanner

Unplug the machine, close the document support and the document tray and then open the top cover. Clean the flat white plate and the glass strip below the bar with isopropyl alcohol on a lint-free cloth.

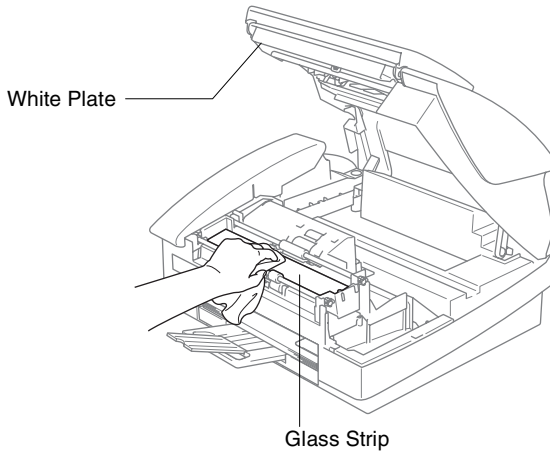

Cleaning the machine Printer Platen

WARNING

- Be sure to unplug the machine from the AC power outlet before cleaning the printer platen.
- Be careful not to touch the paper feed star wheels and encoder film.
- When you want to clean your machine printer platen, wipe it with a lint free cloth that is *dry*.
- If ink is scattered on or around the printer platen be sure to wipe it off with a soft, dry, lint-free cloth.

Encoder Film

Do NOT Touch!

Paper Feed Star Wheel

Do NOT Touch!

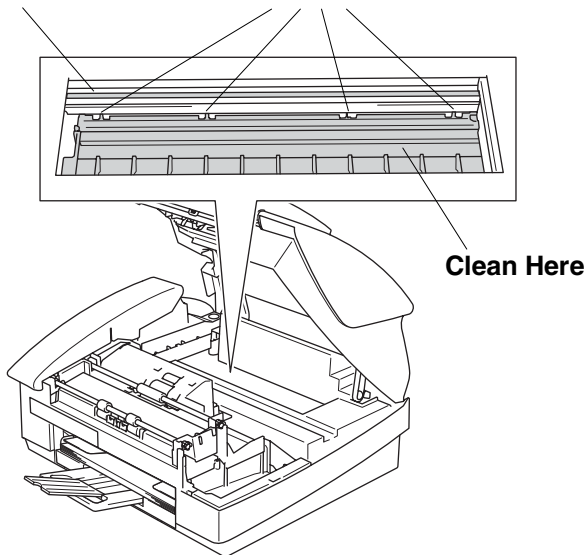

Clean Here

Replacing the ink cartridges

Your machine is equipped with an ink dot counter. The ink dot counter automatically monitors the level of ink in each of the 4 cartridges. When the machine detects an ink cartridge is running out of ink, the machine will notify you with a message on the LCD.

The LCD will inform you which ink cartridge is low or needs replacing. Be sure to follow the LCD prompts to replace the ink cartridges in the correct order.

Even though the machine informs you that an ink cartridge is empty, there will be a small amount of ink remaining in the ink cartridge. It is necessary to keep some ink in the ink cartridge to prevent air from drying out and damaging the print head assembly.

- 1** Close the document support and the document tray.
- 2** Lift the top cover to the open position until it locks securely into place.

If one or more ink cartridges are empty, for example Black, the LCD shows `Ink Empty Black and Open Cover`.

- 3** Pull the ink cartridge hook toward you and remove the ink cartridge for the colour shown on the LCD.

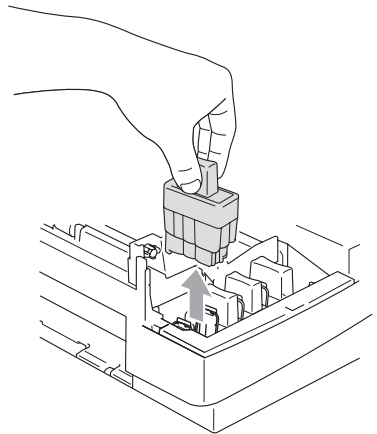
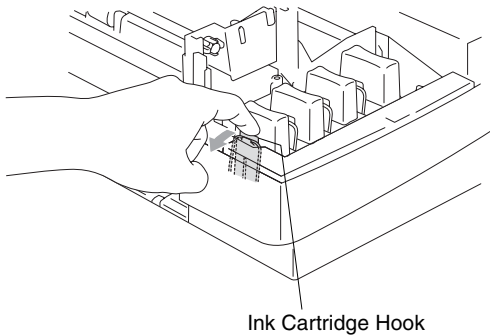

- 4** Open the new ink cartridge bag for the colour shown on the LCD, and then take out the ink cartridge.

5 Remove the cartridge covers.

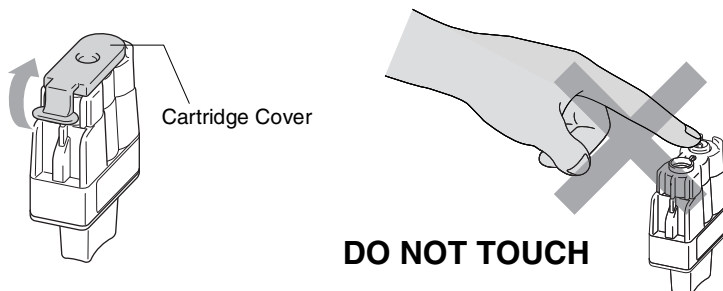

⊘ Do not touch the area shown in the illustration above.

 If the cartridge cover comes off when you open the bag the cartridge will not be damaged.

6 Each colour has its own correct position. Keep the ink cartridge in an upright position when you insert it into slot. Press down on the ink cartridge until the hook snaps over it.

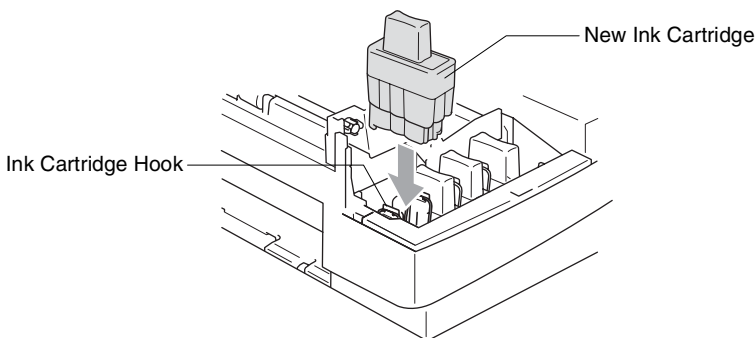

7 If you replaced an ink cartridge while `Near Empty` was displayed on the LCD, the LCD may ask you to verify that it was a brand new one. Example: `Did You Change Blck? 1.Yes 2.No`. For each *new* cartridge you installed, press **1** on the dial pad to automatically reset the ink dot counter for that colour. If the ink cartridge you installed is not a brand new one, please be sure to select **2**.



If you wait until `Ink Empty` message is displayed on the LCD, the machine will automatically reset the ink dot counter.



If the `Install` message is on the display after you have installed ink cartridges, check that the ink cartridges are installed properly.



WARNING

If ink gets in your eyes, irrigate them with water immediately and call a doctor if you are concerned.

 **Caution**

- Do not remove ink cartridges if you do not need to replace them. If you do so, it may reduce the ink quantity and the machine will not know the quantity of ink left in the cartridge.
- Do not touch the cartridge insertion slots. If you do so, the ink may stain your skin.
- If ink stains your skin or clothing, wash with soap or detergent immediately.
- If you install an ink cartridge in the wrong colour position, you must clean the print head several times before you start printing (after correcting the cartridge installation) because the colours were mixed.
- Once you open an ink cartridge, install it in the machine and use it up within six months of installation. Use unopened ink cartridges by the expiration date written on the cartridge package.
- Do not dismantle or tamper with the ink cartridge, this can cause the ink to leak out of the cartridge.
- Brother multifunction machines are designed to work with ink of a particular specification and work to a level of optimum performance when used with genuine Brother ink cartridges. Brother cannot guarantee this optimum performance if ink or ink cartridges of other specifications are used. Brother does not therefore recommend the use of cartridges other than genuine Brother cartridges with this machine or the refilling of empty cartridges with ink from other sources. If damage is caused to the print head or other parts of this machine as a result of the use of ink or ink cartridges other than genuine Brother products due to the incompatibility or lack of suitability of those products with this machine, any repairs required as a result will not be covered by the warranty.

A Appendix A

Telephone Service for Australia

Telstra® FaxStream® Duet® (Distinctive Ringing)

Telstra® FaxStream® Duet® is an enhanced Public Switched Telephone Service (PSTS) offered by Telstra® that allows you to have an additional number on one phone line, with its own distinctive ring pattern. Telstra® FaxStream® Duet® is a call handling feature that helps users distinguish voice and facsimile calls. With FaxStream® Duet®, incoming calls to a fax number are announced by a different, distinctive ring signal. Only one call can be answered (or made) at any one time and while this call is in progress, incoming calls to either number will be presented with a busy tone.

Your MFC has a Distinctive Ringing function, allowing you to dedicate one phone number just for receiving faxes.



After you have set the Distinctive Ring feature to **On**, the receive mode is set to **Manual** automatically. Unless you have a TAD or Voice Mail set up on the Distinctive Ring number, **Manual** mode means you must answer all the calls yourself. You can not change the receive mode to the other mode while the Distinctive Ring is set to on.

What is the Advantage of using Telstra® FaxStream® Duet® Function?

Using Telstra® FaxStream® Duet® is the most efficient way to receive both fax and telephone calls on the same line. When the voice call comes in, all phones (extension and external) and the fax machine will ring to alert you to pick it up. If a fax call comes in, the fax machine will answer automatically without ringing, whereas the extension and external phones will ring with a distinctive ring pattern. It is also a more efficient way of operating a Fax machine with an extension phone as you do not have to use the remote activation codes. It gives you two independent numbers without the higher cost of a second line.

How does Telstra® FaxStream® Duet® Work?

Incoming calls to the voice number, will have the standard ring pattern of long, long tone, followed by a pause, repeated, while the new fax number will have a different ring pattern of three short bursts of ring, repeated at regular intervals.

When FaxStream® Duet® is On and you receive a voice call all extension and external phones will ring with a standard ring pattern. The fax machine will ring on the third ring with a standard ring pattern. All external and the extension phones will continue to ring. Either you or a telephone answering device can answer the voice number.

When FaxStream® Duet® is On and you receive a fax call on the Duet® number the Fax machine will answer and automatically receive the fax message without ringing. On the other hand, all extension and external phones will ring with a distinctive ring pattern. Do not answer the phone as you are receiving a fax message.

Flowchart Sequence of Incoming call

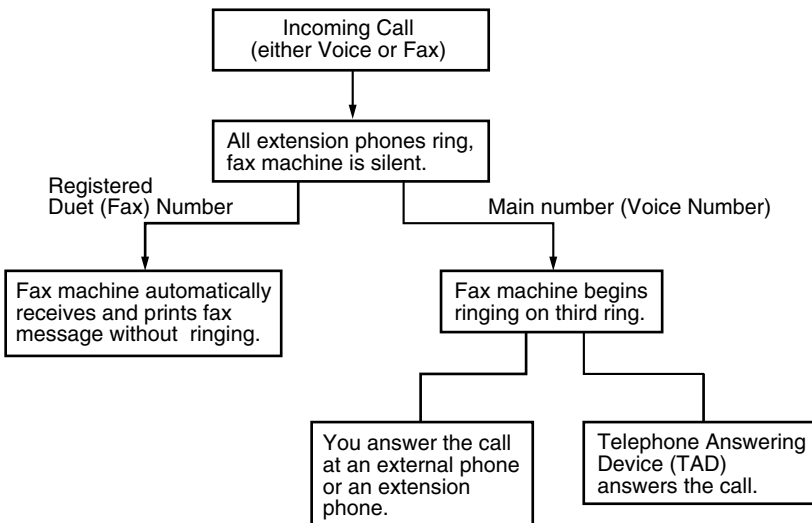

Set the Distinctive Ringing to ON

- 1 Disconnect the fax machine from any TAD or telephone company voice mail.
- 2 Press **Menu/Set, 2, 0, 3.** 3.Distinctive
The screen displays the current setting of this feature.
- 3 Press **▲** or **▼** to select **On** (or **Off**).
- 4 Press **Menu/Set**.
- 5 Press **Stop/Exit**.

Caller ID (Caller Identification)

Caller ID is a telephone service that allows the subscriber to see a display of the caller's phone number or name as the telephone rings. It is a fast way to screen your calls. You can respond quickly to calls you missed, because Caller IDs are received and stored in your MFC memory.



To get the Caller ID Service: apply for the Caller ID service at your local telephone company, if available.

Advantages of Caller ID

For Business

All businesses profit from a quicker response to customer calls. Businesses that provide mail order services, money-lending services or provide confidential information, can protect themselves from false orders or acceptance of false identification.

At Home

Residential customers can protect themselves from unwanted calls.

How Does the Caller ID Work?

The Caller ID Appears on the Display When Your Telephone Rings

As your telephone rings, the display shows you the caller's phone number or name if the name has stored in the One-Touch and Speed-Dial. Once you pick up the handset, the caller's ID disappears. You will see up to the first 16 characters of the number on the display.



- If **Out of Area** appears on the display, it means that the call came from outside your caller ID service area or a public phone. *
- If **Private Call** appears on the display, it means the caller intentionally blocked the transmission of his/her ID. *

* Depends on network Function.

The Caller ID is Stored in Your MFC Memory

The MFC can store a maximum of the last 30 incoming caller IDs in the memory, along with the time and date of reception. The 31st call will cause the oldest ID to be erased.

The Caller ID information stored in the memory can be used for the following.

■ **Printing the Caller ID List.**

You can review calls you received by checking the Caller IDs in memory. This report will list the Date, Time, Phone Number (Caller ID) name, and type of Call (Comment) if available.

Viewing Caller ID List

Caller ID memory stores information for up to thirty calls; when the thirty-first call comes in, information about the first call is erased. You can scroll through Caller ID information to review those calls made to your MFC.

1 Press **Menu/Set**, **2**, **0**, **4**.

4.Caller ID

2 Press **▲** or **▼** to select `Display#` and press **Menu/Set**.

If the name was not received, it will not be displayed.

3 Press **▲** or **▼** to scroll through the Caller ID memory to select the Caller ID you want to view and press **Menu/Set**.

The next screen shows the caller's telephone number and the date and time of the call.

4 Press **Stop/Exit** to exit.

Printing Caller ID List

1 Press **Menu/Set**, **2**, **0**, **4**.

2 Press **▲** or **▼** to select `Print Report`.

3 Press **Menu/Set**.

4 Press **Start**.

Telephone Service for New Zealand

FaxAbility

FaxAbility is a service offered by Telecom that allows you to have an additional number on one phone line, with its own distinctive ring pattern. This way, when you get an incoming call, you can identify the number being called by its ring.

How Will the Fax Machine Treat All Other Numbers?

FaxAbility mode ensures that the machine will answer calls to the FaxAbility (secondary) number. When a call comes in to your main number, all the phones will ring. You can set an external answering device (TAD) to answer calls on the other number(s). (See the chart in the following page.)

What is the Advantage of Using the FaxAbility Function?

Using FaxAbility is the most efficient way to receive both fax and telephone calls on the same line. It is much easier for your callers who dial manually. The fax machine will answer with receiving tones so they will not have to press an activation code. And the people who call to talk on your main number will not have to talk to your fax machine. Basically, it gives you two independent numbers without the higher cost of a second line.

How Does FaxAbility Work?

Your telephone number will have the standard ring pattern of long, long tone, while the new number will have a ring pattern of long, silence, long, etc. When FaxAbility is **On**, you will not hear the first ring of all incoming calls on the fax machine. Extension phones will ring as usual. If the fax machine recognizes the ring pattern, all ringing will stop and the fax machine will answer and automatically receive the fax message. Otherwise, you will hear the extension phones and the fax machine continue to ring. The fax machine always listens to the ring pattern before it answers, so do not pick up the phone during that time. You will quickly learn to recognize the ring pattern for faxes, so you will not be tempted to answer that number. Either you or a telephone answering device can answer the main number(s).

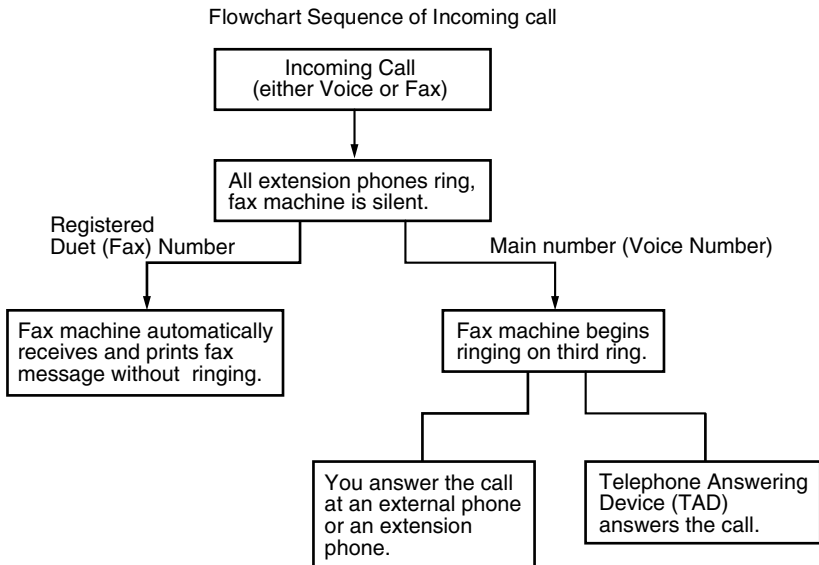

After you have set the FaxAbility feature to **On**, the receive mode is set to **Manual** automatically. Unless you have a TAD or Voice Mail set up on the FaxAbility number, Manual mode means you must answer all the call yourself. You can not change the receive mode to the other mode while the FaxAbility is set to on.

How to Turn FaxAbility OFF or ON

The FaxAbility function is designed to accommodate the FaxAbility service provided by Telecom. To change the setting, repeat Steps 1-3; Step 2 is where you can select either *On* or *Off*.

Call Waiting beeps caused by incoming calls on your main number can affect fax transmissions. If you have FaxAbility Service but don't have Call Waiting, you need do nothing at this stage. If you do have Call Waiting as well as FaxAbility, set the Call Waiting menu option to *On*. See below.

1 Press **Menu/Set, 2, 0, 3**.

3.Faxability

The screen displays

2 Press **▲** or **▼** to set FaxAbility to *On* or *Off*.

If you have FaxAbility service, select *On*.

3 Press **Menu/Set**.

4 Press **▲** or **▼** to set Call Waiting to *On* or *Off*. If you have Call Waiting service, select *On* to avoid the trouble caused by Call Waiting.

5 Press **Menu/Set**.

6 Press **Stop/Exit**.

Caller ID (Caller Identification)

Caller ID is a telephone service that allows the subscriber to see a display of the caller's phone number and name if available as the telephone rings. It is a fast way to screen your calls. You can respond quickly to calls you missed, because Caller IDs are received and stored in your MFC memory.



To get the Caller ID Service: apply for the Caller ID service at your local telephone company, if available.

Advantages of Caller ID

For Business

All businesses profit from a quicker response to customer calls. Businesses that provide mail order services, money-lending services or provide confidential information, can protect themselves from false orders or acceptance of false identification.

At Home

Residential customers can protect themselves from unwanted calls.

How Does the Caller ID Work?

The Caller ID Appears on the Display When Your Telephone Rings

As your telephone rings, the display shows you the caller's phone number and name if available. Once you pick up the handset, the caller's ID disappears. You will see up to the first 16 characters of the number and name if available on the display.



- If `Out of Area` appears on the display, it means that the call came from outside your caller ID service area. *
- If `Private Call` appears on the display, it means the caller intentionally blocked the transmission of his/her ID. *

* Depends on network Function.

Viewing Caller ID List

Caller ID memory stores information for up to thirty calls; when the thirty-first call comes in, information about the first call is erased. You can scroll through Caller ID information to review those calls made to your MFC.

1 Press **Menu/Set, 2, 0, 4.**

4. Caller ID

2 Press **▲** or **▼** to select `Display#` and press **Menu/Set.**

If the name was not received, it will not be displayed.

3 Press **▲** or **▼** to scroll through the Caller ID memory to select the Caller ID you want to view and press **Menu/Set.**

The next screen shows the caller's telephone number and the date and time of the call.

4 Press **Stop/Exit.**

Printing Caller ID List

1 Press **Menu/Set, 2, 0, 4.**

2 Press **▲** or **▼** to select `Print Report.`

3 Press **Menu/Set.**

4 Press **Start.**



If you use the Caller ID for Dial back...

- Please be sure that you use appropriate dialling procedures for local and national call.
- Please be sure that you make sure of the details of the exact number to be called back, and the need to insert prefix(es) for manual dialling.
- Please understand that your MFC may not display precisely the digits to be called.

Telephone Service for Some Countries

Distinctive Ringing (For Singapore and Hong Kong)

This MFC feature lets you use the Distinctive Ringing subscriber service offered by some telephone companies, which allows you to have several telephone numbers on one phone line. Each phone number has its own Distinctive Ringing pattern, so you will know which phone number is ringing. This is one way you can have a separate phone number for your MFC.

Your MFC has a Distinctive Ringing function, allowing you to dedicate one phone number just for receiving faxes. You will need to set Distinctive Ringing to **On**.



You can switch it off temporarily, then turn it back on. When you get a new fax number, make sure you reset this function.

- The MFC will answer only calls to the Distinctive Ringing number.



After you have set the Distinctive Ring feature to **On**, the receive mode is set to **Manual** automatically. Unless you have a TAD or Voice Mail set up on the Distinctive Ring number, **Manual** mode means you must answer all the call yourself. You can not change the receive mode to the other mode while the Distinctive Ring is set to **on**.

Setting the Distinctive Ringing

- 1** Press **Menu/Set**, **2**, **0**, **3**.
- 2** Press **▲** or **▼** to select **On** (or **Off**).
- 3** Press **Menu/Set**.
- 4** Press **Stop/Exit**.

3.Distinctive

Caller ID (For Singapore and Hong Kong)

The Caller ID feature of this MFC lets you use the Caller ID subscriber service offered by many local phone companies. This service provides you, by means of the screen display, the telephone number (or name) of your caller as the line rings. (See *Printing Caller ID List* on page A-13.)

After a few rings, the screen displays the telephone number of your caller (or name, if available). Once you pick up the handset, the Caller ID information disappears from the screen, but the call information remains stored in the Caller ID memory.

- You will see the first 16 characters of the number or name.
- `Out of Area` display means call originates outside your Caller ID service area.
- `Private Call` display means the caller has intentionally blocked transmission of information.



You can print a list of Caller ID information received by your MFC.

Caller ID service varies with different carriers. Call your local phone company to determine the kind of service available in your area.

Viewing Caller ID List

Caller ID memory stores information for up to thirty calls; when the thirty-first call comes in, information about the first call is erased. You can scroll through Caller ID information to review those calls made to your machine.

1 Press **Menu/Set**, **2**, **0**, **4**.

4.Caller ID

2 Press **▲** or **▼** to select `Display#` and press **Menu/Set**.

If the name was not received, it will not be displayed.

3 Press **▲** or **▼** to scroll through the Caller ID memory to select the Caller ID you want to view and press **Menu/Set**.

The next screen shows the caller's telephone number and the date and time of the call.

4 Press **Stop/Exit**.

Printing Caller ID List

1 Press **Menu/Set**, **2**, **0**, **4**.

2 Press **▲** or **▼** to select `Print Report` and press **Menu/Set**.

3 Press **Start**.

Advanced receiving operations

Operation from extension telephones

If you answer a fax call on an extension telephone, or an external telephone into the correct socket on the machine, you can make your machine take the call by using the Fax Receive Code. When you press the Fax Receive Code *51 (*91 for New Zealand), the machine starts to receive a fax. (See *Fax Detect (MFC-3240C only)* on page 4-4 or *Fax Detect (FAX-1840C only)* on page 4-5.)

If the machine answers a voice call and pseudo/double-rings for you to take over, use the Telephone Answer Code #51 (#91 for New Zealand) to take the call at an extension phone. (See *Setting the F/T Ring Time (Fax/Tel mode only)* on page 4-3.)

If you answer a call and no one is on the line, you should assume that you're receiving a manual fax.

- Press *51 (*91 for New Zealand) and wait for the chirp or until the machine's LCD displays *Receiving*, and then hang up.

Your caller will have to press **Start** to send the fax.

Fax/Tel mode

When the machine is in Fax/Tel mode, it will use the F/T Ring Time (pseudo/double-ringing) to alert you to pick up a voice call.

If you are at an extension phone, you'll need to lift the handset during the F/T Ring Time and then press **#51** (**#91** for New Zealand) between the pseudo/double rings. If no one is on the line, or if someone wants to send you a fax, send the call back to the machine by pressing *** 51** (*** 91** for New Zealand).

Fax/Tel mode in the Power Save condition

For FAX-1840C:

When the machine is in Fax/Tel mode and pseudo/double-rings to alert you to pick up a voice call, you can only answer by picking up the machine's handset.

If you answer *before* the machine answers with pseudo/double-ringing, you can pick up the call at an external or extension phone.

For MFC-3240C:

Fax/Tel mode does not work in the power save condition. The machine will not answer telephone or fax calls and will keep ringing. If you are at an external or extension phone, lift the handset of the extension phone and talk. If you hear fax tones, hold the handset until Fax Detect activates your machine. If the other party says they want to send you a fax, activate the machine by pressing *** 51** (*** 91** for New Zealand).

Using a cordless external handset

If the base unit of your cordless telephone is connected (see page A-17) and you typically carry the cordless handset elsewhere, it is easier to answer calls during the Ring Delay.



Not all brands of cordless phones are compatible for use with your MFC.

Changing the remote codes

Remote Codes might not work with some telephone systems. The preset Fax Receive Code is *51 (*91 for New Zealand). The preset Telephone Answer Code is #51 (#91 for New Zealand).



If you are always disconnected when accessing your external TAD remotely, try changing the Fax Receive Code and Telephone Answer Code to another three-digit code (such as ### and 999).

1 If it is not illuminated in green, press  (Fax).

2 Press **Menu/Set**, **2**, **1**, **4**.

4.Remote Code

3 Press ▲ or ▼ to select On (or Off).

Press **Menu/Set**.

4 Enter the new Fax Receive Code.

Press **Menu/Set**.

5 Enter the new Telephone Answer Code.

Press **Menu/Set**.

6 Press **Stop/Exit**.

Connecting an external device to your machine

Connecting an external telephone

You can connect a separate telephone as shown in the diagram below.

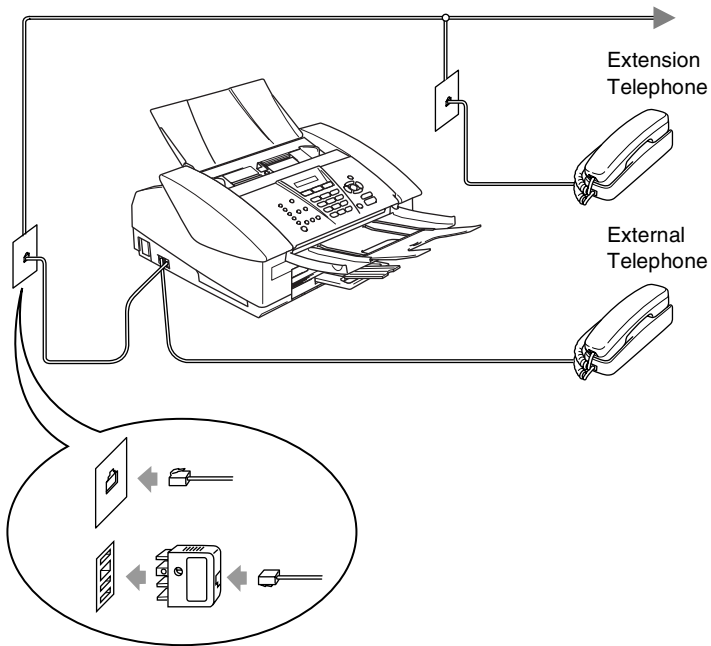

When you are using external or extension phone, the LCD shows **Telephone (MFC-3240C only)** or **Ext. Tel in Use (FAX-1840C only)**.

Connecting an external telephone answering device (TAD)

Sequence

You may choose to connect an additional answering device. However, when you have an **external** TAD on the same telephone line as the machine, the TAD answers all calls and the machine “listens” for fax calling (CNG) tones. If it hears them, the machine takes over the call and receives the fax. If it does not hear CNG tones, the machine lets the TAD continue playing your outgoing message so your caller can leave you a voice message.

The TAD must answer within four rings (the recommended setting is two rings). The machine cannot hear CNG tones until the TAD has answered the call, and with four rings there are only 8 to 10 seconds of CNG tones left for the fax “handshake”. Make sure you carefully follow the instructions in this guide for recording your outgoing message. We do not recommend using the toll saver feature on your external answering machine if it exceeds five rings.



If you do not receive all your faxes, reduce the Ring Delay setting on your external TAD to one or two rings.

⊘ Do not connect a TAD elsewhere on the same phone line.

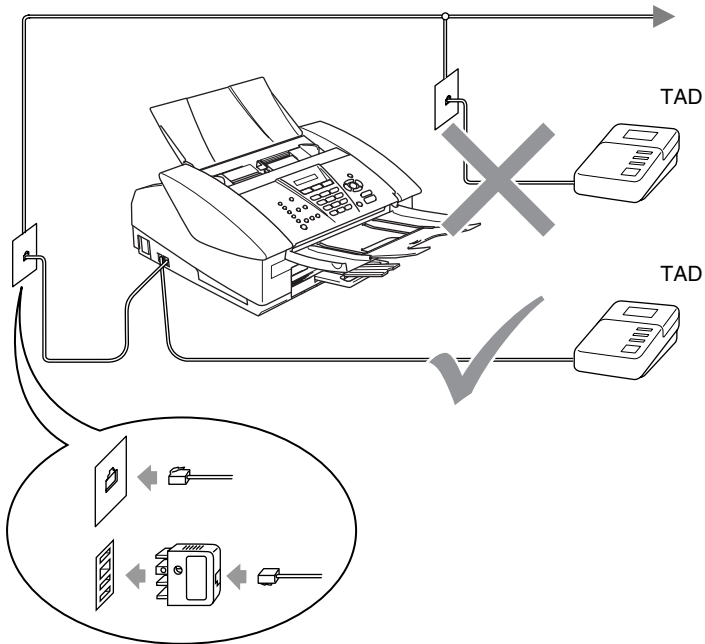

When you are using a TAD, the LCD shows `Telephone` (MFC-3240C only) or `Ext. Tel in Use` (FAX-1840C only).

Connections

The external TAD must be connected as shown above.

- 1** Set your external TAD to one or two rings. (The machine's Ring Delay setting does not apply.)
- 2** Record the outgoing message on your external TAD.
- 3** Set the TAD to answer calls.
- 4** Set the Receive Mode to `External TAD`.
(See *Choosing the Receive Mode* on page 4-1.)

Recording outgoing message (OGM) on an external TAD

Timing is important in recording this message. The message sets up the ways to handle both manual and automatic fax reception.

- 1** Record 5 seconds of silence at the beginning of your message. (This allows your machine time to listen for the fax CNG tones of automatic transmissions before they stop.)
- 2** Limit your speaking to 20 seconds.



We recommend beginning your OGM with an initial 5-second silence because the machine cannot hear fax tones over a resonant or loud voice. You may try omitting this pause, but if your machine has trouble receiving, then you must re-record the OGM to include it.

Multi-line connections (PBX) (For Australia and New Zealand only)

Most offices use a central telephone system. While it is often relatively simple to connect the machine to a key system or a PBX (Private Branch Exchange), we suggest that you contact the company that installed your telephone system and ask them to connect the machine for you. It is advisable to have a separate line for the machine.

If the machine is to be connected to a multi-line system, ask your installer to connect the unit to the last line on the system. This prevents the unit from being activated each time a telephone call is received.

If you are installing the machine to work with a PBX

- 1** It is not guaranteed that the unit will operate properly under all circumstances with a PBX. Any cases of difficulty should be reported first to the company that handles your PBX.
- 2** If all incoming calls will be answered by a switchboard operator, it is recommended that the Receive Mode be set to *Manual*. All incoming calls should initially be regarded as telephone calls.

Custom features on your phone line

If you have Voice Mail, Call Waiting, Call Waiting/Caller ID, RingMaster, an answering service, an alarm system EFTPOS, PC/FAX modem or other custom feature on one phone line it may create a problem with the operation of your machine. (See *Custom features on a single line*. on page 10-11.)

B Appendix B

On-screen programming

Your machine is designed to be easy to use with LCD on-screen programming using the navigation keys. User-friendly programming helps you take full advantage of all the menu selections your machine has to offer.

Since your programming is done on the LCD, we have created step-by-step on-screen instructions to help you program your machine. All you need to do is follow the instructions as they guide you through the menu selections and programming options.

Menu table

You can probably program your machine without the User's Guide if you use the Menu table that begins on page B-3. These pages will help you understand the menu selections and options that are found in the machine's programs.



You can program your machine by pressing **Menu/Set**, followed by the menu numbers.

For example to set `Fax Resolution` to `Fine`:







Press **Menu/Set**, **2**, **2**, **2** and **▲** or **▼** to select `Fine`.

Press **Menu/Set**.

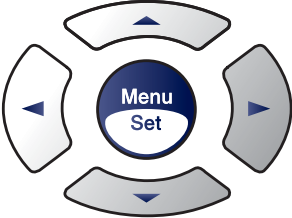
Memory storage

If there is a power failure, you will not lose your menu settings because they are stored permanently. Temporary settings (such as Contrast, Overseas Mode, and so on) will be lost. You may also have to reset the date and time.

Navigation keys

		Access the menu Go to the next menu level Accept an option
	 	Scroll through the current menu level
		Go back to the previous menu level
		Exit the menu

You can access the menu mode by pressing **Menu/Set**.

When you enter the menu, the LCD scrolls.

Press **1** for General Setup menu

1.General Setup

—OR—

Press **2** for Fax menu

2.Fax

—OR—

Press **3** for Copy menu

3.Copy

⋮

Press **0** for Initial Setup

0.Initial Setup

You can scroll more quickly through each menu level by pressing the arrow for the direction you want: ▲ or ▼.

Select an option by pressing **Menu/Set** when that option appears on the LCD.

The LCD will then show the next menu level.

Press ▲ or ▼ to scroll to your next menu selection.

Press **Menu/Set**.

When you finish setting an option, the LCD shows *Accepted*.

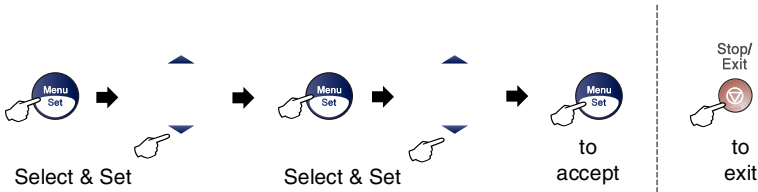

Main Menu	Submenu	Menu Selections	Options	Descriptions	Page	
1.General Setup	1.Mode Timer	—	5 Mins 2 Mins 1 Min 30 Secs (Default for MFC-3240C) 0 Sec (Default for FAX-1840C) Off	Sets the time to return to Fax mode.	2-4	
	2.Paper Type	—	Plain Inkjet Glossy Transprncy	Sets the type of paper in the paper tray.	2-6	
	3.Paper Size	—	Letter Legal A4 A5 10x15cm	Sets the size of the paper in the paper tray.	2-6	
	4.Volume	1.Ring	—	High Med Low Off	Adjusts the ring volume.	2-7
		2.Beeper	—	High Med Low Off	Adjusts the volume level of the beeper.	2-7
		3.Speaker	—	High Med Low Off	Adjusts the speaker volume.	2-8
	5.Auto Daylight	—	On Off	Changes for Daylight Savings Time automatically.	2-8	



The factory settings are shown in Bold.

Main Menu	Submenu	Menu Selections	Options	Descriptions	Page
1.General Setup (Continued)	6.P.Save Setting	—	On Off	Customizes the Power Save key not to receive fax in power save condition.	1-6
	7.LCD Contrast	—	Light Dark	Adjust the contrast of the LCD.	2-8
2.Fax	1.Setup Receive (In Fax mode only)	1.Ring Delay	02-10(02) (Example for Australia)	Sets the number of rings before the machine answers in Fax Only or Fax/Tel mode.	4-2
		2.F/T Ring Time	70 Sec 40 Sec 30 Sec 20 Sec (Example for Australia)	Sets the pseudo/double-ring time in Fax/Tel mode.	4-3
		3.Fax Detect	On Semi (FAX-1840C only) Off	Receives fax messages without pressing the Mono Start or Colour Start key.	4-4
		4.Remote Code	On (* 51, #51) (* 91, #91 for New Zealand) Off	You can answer all calls at an extension or external phone and use codes to turn the machine on or off. You can personalize these codes.	A-16
		5.Auto Reduction	On Off	Reduces the size of incoming faxes.	4-6
		6.Memory Receive	On Off	Automatically stores any incoming faxes in its memory if it runs out of paper.	4-7
		7.Polling RX	Standard Secure Timer	Sets up your machine to poll another fax machine.	4-8



The factory settings are shown in Bold.

Main Menu	Submenu	Menu Selections	Options	Descriptions	Page
2.Fax (Continued)	2.Setup Send (In Fax mode only)	1.Contrast	Auto Light Dark	Changes the lightness or darkness of faxes you send.	3-6
		2.Fax Resolution	Standard Fine S.Fine Photo	Sets the default resolution for outgoing faxes.	3-7
		3.Delayed Fax	—	Set the time of day in 24 hour format that the delayed faxes will be sent.	3-13
		4.Batch TX	On Off	Combines delayed faxes to the same fax number at the same time of day into one transmission.	3-14
		5.Real Time TX	Off On Next Fax Only	You can send a fax without using the memory.	3-9
		6.Polled TX	Standard Secure	Sets up the document on your machine to be retrieved by another fax machine.	3-15
		7.Overseas Mode	On Off	If you are having difficulty sending faxes overseas, set this to On.	3-12
	3.Set Quick-Dial	1.One-Touch Dial		Stores One-Touch Dial numbers, so you can dial by pressing one key (and Start).	5-1
		2.Speed-Dial	—	Stores Speed-Dial numbers, so you can dial by pressing only a few keys (and Start).	5-2
		3.Setup Groups	—	Sets up a Group number for Broadcasting.	5-4



The factory settings are shown in **Bold**.

Main Menu	Submenu	Menu Selections	Options	Descriptions	Page	
2.Fax (Continued)	4.Report Setting	1.Transmission	On On+Image Off Off+Image	Initial setup for Transmission Verification Report and Journal Report.	7-1	
		2.Journal Period	Every 7 Days Every 2 Days Every 24 Hours Every 12 Hours Every 6 Hours Every 50 Faxes Off		7-2	
	5.Remote Fax Opt	1.Forward/ Store	Off Fax Forward Fax Storage	Sets the machine to forward fax messages, to store incoming faxes in the memory (so you can retrieve them while you are away from your machine).	6-2	
		2.Remote Access	---*	You must set your own code for Remote Retrieval.	6-3	
		3.Print Document	—	Prints incoming faxes stored in the memory.	4-7	
	6.Remaining Jobs	—	—	Checks which jobs are in the memory and lets you cancel selected jobs.	3-10	
	0.Miscellaneous	1.TX Lock (1.Key Lock)	—	—	Prohibits most functions except receiving faxes.	3-17
		2.Compatibility	High (MFC-3240C only) Normal Basic	Adjust the Equalization for transmission problems.	10-12	
		3.Distinctive (Not available in New Zealand)	On Off	Use with phone company distinctive ringing service to register the ring pattern with the machine.	A-1 A-11	
		3.Faxability (For New Zealand Only)	On Off	If you have FaxAbility from Telecom, you can use this function to store the ringing pattern of your fax number. And if you set in to ON, you should use the registered number only.	A-6	
		4.Caller ID	Display# Print Report	View or print a list of the last 30 Caller IDs stored in memory.	A-3 A-9 A-12	



The factory settings are shown in Bold.

Main Menu	Submenu	Menu Selections	Options	Descriptions	Page	
3.Copy	1.Quality	—	Best Normal Fast	Selects the Copy resolution for your type of document.	8-12	
	2.Brightness	—	- □□□□ ■ + - □□□□ □ + - □□□□ ■ + - □■□□□ + - ■□□□□ +	Adjusts the brightness.	8-12	
	3.Contrast	—	- □□□□ ■ + - □□□□ □ + - □□□□ ■ + - □■□□□ + - ■□□□□ +	Adjusts the contrast for copies.	8-13	
	4.Color Adjust	1.Red		R:- □□□□ ■ + R:- □□□□ □ + R:- □□□□ ■ + R:- □■□□□ + R:- ■□□□□ +	Adjusts the amount of Red in copies.	8-13
		2.Green		G:- □□□□ ■ + G:- □□□□ □ + G:- □□□□ ■ + G:- □■□□□ + G:- ■□□□□ +	Adjusts the amount of Green in copies.	
		3.Blue		B:- □□□□ ■ + B:- □□□□ □ + B:- □□□□ ■ + B:- □■□□□ + B:- ■□□□□ +	Adjusts the amount of Blue in copies.	
	4.Print Reports (MFC-3240C only)	1.Help List	—	—	You can print these lists and reports.	7-3
2.Quick-Dial		—	—			
3.Fax Journal		—	—			
4.XMIT Verify		—	—			



The factory settings are shown in Bold.

Main Menu	Submenu	Menu Selections	Options	Descriptions	Page
0.Initial Setup	1.Receive Mode	—	Fax Only Fax/Tel External TAD Manual	You can choose the receive mode that best suits your needs.	4-1 4-2
	2.Date/Time	—	—	Puts the date and time on the LCD and in headings of faxes you send.	2-1
	3.Station ID	—	Fax: Name:	Program your name and fax number to appear on each page you fax.	2-2
	4.Tone/Pulse (Not available in New Zealand)	—	Tone Pulse	Selects the dialling mode.	2-1
	5.Phone Line Set	—	PBX (For Australia and New Zealand only) ADSL Normal	Select the phone line type.	2-3



The factory settings are shown in Bold.

Entering Text

When you are setting certain menu selections, such as the Station ID, you may need to type text into the machine. Most number keys have three or four letters printed above them. The keys for **0**, **#** and ***** do not have printed letters because they are used for special characters.

By pressing the appropriate number key repeatedly, you can access the character you want.

Press Key	one time	two times	three times	four times
2	A	B	C	2
3	D	E	F	3
4	G	H	I	4
5	J	K	L	5
6	M	N	O	6
7	P	Q	R	S
8	T	U	V	8
9	W	X	Y	Z

Inserting spaces

To enter a space in the fax number, press **▶** once between numbers. To enter a space in the name, press **▶** twice between characters.

Making corrections

If you entered a letter incorrectly and want to change it, press **◀** to move the cursor under the incorrect character. Then press **Stop/Exit**. All letters above and to the right of the cursor will be deleted. Re-enter the correct character. You can also back up and type over incorrect letters.

Repeating letters

If you need to enter a character that is on the same key as the previous character, press **▶** to move the cursor to the right before you press the key again.

Special characters and symbols

Press *****, **#** or **0**, and then press **◀** or **▶** to move the cursor under the special character or symbol you want. Then press **Menu/Set** to select it.

Press ***** for (space) ! " # \$ % & ' () * + , - . / €

Press **#** for : ; < = > ? @ [] ^ _

Press **0** for Ä Ë Ö Ü À Ç È É 0

G Glossary

ADF (automatic document feeder) Documents can be placed in the ADF and scanned one page at a time automatically.

Auto Reduction Reduces the size of incoming faxes.

Automatic fax transmission (MFC-3240C only) Sending a fax without picking up the handset of an external phone.

Automatic fax transmission (FAX-1840C only) Sending a fax without picking up the handset of the machine.

Automatic Redial A feature that enables your machine to redial the last fax number after five minutes if the fax did not go through because the line was busy.

Backup Print Your machine prints a copy of every fax that is received and stored in memory. This is a safety feature so you will not lose messages during a power failure.

Batch Transmission (Black and white faxes only) As a cost saving feature, all delayed faxes to the same fax number will be sent as one transmission.

Beeper Volume Volume setting for the beep when you press a key or make an error.

Brightness Changing the Brightness makes the whole image lighter or darker.

Broadcasting The ability to send the same fax message to more than one location.

Cancel Job Cancels a programmed job, like Delayed Fax or Polling.

CNG tones The special tones (beeps) sent by fax machines during automatic transmission to tell the receiving machine that a fax machine is calling.

Coding method Method of coding the information contained in the document. All fax machines must use a minimum standard of Modified Huffman (MH). Your machine is capable of greater compression methods, Modified Read (MR), Modified Modified Read (MMR) and JPEG, if the receiving machine has the same capability.

- Communication error (or Comm. Error)** An error during fax sending or receiving, usually caused by line noise or static.
- Compatibility group** The ability of one fax unit to communicate with another. Compatibility is assured between ITU-T Groups.
- Contrast** Setting to compensate for dark or light documents, by making faxes or copies of dark documents lighter and light documents darker.
- Delayed Fax** Sends your fax at a specified later time that day.
- Distinctive Ring** A subscriber service purchased from the telephone company that gives you another phone number on an existing phone line. The Brother machine uses the new number to simulate a dedicated fax line.
- Dual Access** Your machine can scan outgoing faxes or scheduled jobs into memory at the same time it is sending a fax or receiving or printing an incoming fax.
- ECM (Error Correction Mode)** Detects errors during fax transmission and resends the pages of the fax that had an error.
- Extension phone** A telephone on the fax number that is plugged into a separate wall socket.
- External phone** A TAD (telephone answering device) or telephone that is connected to your machine.
- F/T Ring Time** The length of time that the Brother machine rings (when the Receive Mode setting is Fax/Tel) to notify you to pick up a voice call that it answered.
- Fax Detect** Enables your machine to respond to CNG tones if you interrupt a fax call by answering it.
- Fax Forwarding** Sends a fax received into the memory to another pre-programmed fax number.
- Fax Journal** Lists information about the last 200 incoming and outgoing faxes. TX means Transmit. RX means Receive.
- Fax Receive Code** Press this code (* **51**, * **91** for New Zealand) when you answer a fax call on an extension or external phone.
- Fax Storage** You can store faxes in memory.

Fax tones The signals sent by sending and receiving fax machines while communicating information.

Fax/Tel You can receive faxes and telephone calls. Do not use this mode if you are using a telephone answering device (TAD).

Fine resolution Resolution is 203 x 196 dpi. It is used for small print and graphs.

Gray scale The shades of gray available for copying and faxing photographs.

Group number A combination of One-Touch and Speed-Dial numbers that are stored on a One-Touch key or in a Speed-Dial location for Broadcasting.

Help list A printout of the complete Menu table that you can use to program your machine when you do not have the User's Guide with you.

Journal Period The pre-programmed time period between automatically printed Fax Journal Reports. You can print the Fax Journal on demand without interrupting the cycle.

LCD (liquid crystal display) The display screen on the machine that shows interactive messages during On-Screen Programming and shows the date and time when the machine is idle.

Manual fax When you lift the handset of the machine (FAX-1840C only) or external telephone so you can hear the receiving fax machine answer before you press **Mono Start** or **Colour Start** to begin transmission.

Menu mode Programming mode for changing your machine's settings.

OCR (optical character recognition) (MFC-3240C only) The bundled ScanSoft® OmniPage® software application converts an image of text to text you can edit.

One-Touch Keys on the machine's control panel where you can store numbers for easy dialling. You can store a second number on each key if you press **Shift** and the One-Touch Key together.

Out of Paper Reception Receives faxes into the machine's memory when the machine is out of paper.

- Overseas Mode** Makes temporary changes to the fax tones to accommodate noise and static on overseas phone lines.
- Pause** Allows you to place a 3.5 second delay in the dialling sequence stored on One-Touch keys and Speed-Dial numbers. Press **Redial/Pause** as many times as needed for longer pauses.
- Photo resolution** A resolution setting that uses varying shades of gray for the best representation of photographs.
- Polling** The process of a fax machine calling another fax machine to retrieve waiting fax messages.
- Pulse** A form of rotary dialling on a telephone line.
- Quick Dial List** A listing of names and numbers stored in One-Touch and Speed-Dial memory, in numerical order.
- Real Time Transmission** When memory is full, you can send faxes in real time.
- Remaining jobs** You can check which jobs are waiting in memory and cancel jobs individually.
- Remote Access Code** Your own four-digit code (--- ✳) that allows you to call and access your machine from a remote location.
- Remote Retrieval Access** The ability to access your machine remotely from a touch tone phone.
- Resolution** The number of vertical and horizontal lines per inch. See: Standard, Fine, Super Fine and Photo.
- Ring Delay** The number of rings before the machine answers in Fax Only and Fax/Tel mode.
- Ring Volume** Volume setting for the machine's ring.
- Scanning (MFC-3240C only)** The process of sending an electronic image of a paper document into your computer.
- Search** An electronic, alphabetical listing of stored One-Touch, Speed-Dial and Group numbers.
- Speed-Dial** A pre-programmed number for easy dialling. You must press the **Search/Speed Dial**, #, and the two digit code, and **Mono Start** or **Colour Start** to start the dialling process.

Standard resolution 203 x 97 dpi. It is used for regular size text and quickest transmission.

Station ID The stored information that appears on the top of faxed pages. It includes the sender's name and fax number.

Super Fine resolution 392 x 203 dpi. Best for very small print and line art.

TAD (telephone answering device) You can connect an external TAD to your machine.

Temporary settings You can select certain options for each fax transmission and copy without changing the default settings.

Tone A form of dialling on the telephone line used for Touch Tone telephones.

Transmission The process of sending faxes over the phone lines from your machine to the receiving fax machine.

User Settings A printed report that shows the current settings of the machine.

Xmit Report (Transmission Verification Report) A listing for each transmission, that shows its date, time and number.

S Specifications

Product description

General

Memory Capacity	8 MB
Automatic Document Feeder (ADF)	Up to 20 pages Temperature: 20°C - 30°C Humidity: 50% - 70% Paper: 80 gsm A4 size
Paper Tray	100 Sheets 80 gsm
Printer Type	Ink Jet
Print Method	Piezo with 74 × 5 nozzles
LCD (Liquid Crystal Display)	16 characters × 1 line
Power Source	220 - 240V 50/60Hz
Power Consumption	(FAX-1840C) Minimum: Less than 4 Wh Standby: 8 Wh or less Peak: 24 Wh or less (MFC-3240C) Minimum: Less than 3.5 Wh Standby: 8 Wh or less Peak: 24 Wh or less

Dimensions

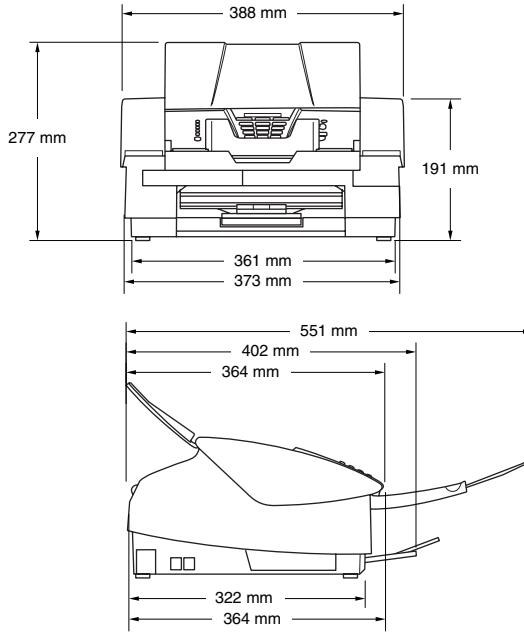

Weight

5 kg

Noise

Operating: 42.5 to 51 dB*

* It depends on printing conditions

Temperature

Operating: 105 - 35°C

Best Print

Quality: 20 - 33°C

Humidity

Operating: 20 to 80% (without condensation)

Best Print

Quality: 20 to 80% (without condensation)

Print media

Paper Input

Paper Tray

- Paper type:
Plain paper, inkjet paper (coated paper), glossy paper*², transparencies*^{1*2} and envelopes
- Paper size:
Letter, Legal*³, Executive, A4, A5, A6, JIS_B5, envelopes (commercial No.10, DL, C5, Monarch, JE4), Photo card, Index card and Post card.
For more details, see *Paper weight, thickness and capacity* on page 1-12.
- Maximum paper tray capacity: Approx. 100 sheets of 80 gsm plain paper

Paper Output

Up to 50 sheets of Letter (A4) plain paper (Face up print delivery to the output paper tray)*²

*¹ Use only transparencies recommended for inkjet printing.

*² For glossy paper or transparencies, we recommend removing printed pages from the output paper tray immediately after they exit the machine to avoid smudging.

*³ Legal paper cannot be stacked on the output paper tray.

Copy

Colour/Mono

Colour/Black

Document Size

ADF Width: 89 mm to 216 mm

ADF Height: 127 mm to 356 mm

Copy Speed

Mono

Up to 17 pages/minute (Letter/A4 paper)*

Colour

Up to 11 pages/minute (Letter/A4 paper)*

* Does not include the time it takes to feed the paper.

Based on Brother standard pattern. (Fast mode/Stack Copy)

Copy speeds vary with the complexity of the document.

Multiple Copies

Stacks up to 99 pages

Enlarge/Reduce

25% to 400% (in increments of 1%)

Resolution

Up to 600 x 1200 dpi copy resolution for plain, inkjet or glossy paper and up to 1200 x 1200 dpi for OHP/transparency

Fax

Compatibility	ITU-T Group 3
Coding System	MH/MR/MMR/JPEG
Modem Speed	Automatic Fallback 14400 bps (FAX-1840C) 33600 bps (MFC-3240C)
Document Size	ADF Width: 89 mm to 216 mm ADF Height: 127 mm to 356 mm
Scanning Width	208 mm
Printing Width	204 mm
Gray Scale	256 levels
Polling Types	Standard, Secure, Timer Sequential: (B&W only)
Contrast Control	Automatic/Light/Dark (manual setting)
Resolution	<ul style="list-style-type: none">• Horizontal 203 dot/inch (8 dot/mm)• Vertical Standard -<ul style="list-style-type: none">98 line/inch (3.85 line/mm) (Mono)196 line/inch (7.7 line/mm) (Colour)Fine - 196 line/inch (7.7 line/mm) (Mono/Colour)Photo - 196 line/inch (7.7 line/mm) (Mono)Superfine - 392 line/inch (15.4 line/mm) (Mono)
One-Touch Dial	10 (5 x 2)
Speed-Dial	40 stations
Broadcasting	100 stations
Automatic Redial	3 times at 5 minute intervals
Auto Answer	2, 3, 4, 5, 6, 7, 8, 9 or 10 rings (for Australia) 1, 2, 3, 4, 5, 6, 7, 8, 9 or 10 rings (for New Zealand) 0, 1, 2, 3, 4, 5, 6, 7, 8, 9 or 10 rings (for some countries)

Communication Source	Public Switched Telephone Network.
Memory Transmission	Up to 300* ¹ /250* ² pages (FAX-1840C) Up to 200* ¹ /170* ² pages (MFC-3240C)
Out of Paper Reception	Up to 300* ¹ /250* ² pages (FAX-1840C) Up to 200* ¹ /170* ² pages (MFC-3240C)

*1 "Pages" refers to the "Brother Standard Chart No. 1" (a typical business letter, Standard resolution, MMR code). Specifications and printed materials are subject to change without prior notice.

*2 "Pages" refers to the "ITU-T Test Chart #1" (a typical business letter, Standard resolution, MMR code). Specifications and printed materials are subject to change without prior notice.

Scanner (MFC-3240C only)

Colour/Monochrome	Colour/Monochrome
TWAIN Compliant	Yes (Windows [®] 98/98SE/Me/2000 Professional/XP) Mac OS [®] 8.6-9.2/Mac OS [®] X 10.2.4 or greater
WIA Compliant	Yes (Windows [®] XP)
Colour Depth	36 bit colour (Input) 24 bit colour (Output)
Resolution	Up to 2400 × 2400 dpi (interpolated)* Up to 600 × 1200 dpi (optical) * Maximum 1200 x 1200 dpi scanning with Windows [®] XP (resolution up to 2400 x 2400 dpi can be selected by using the Brother scanner utility)
Scanning Speed	Colour: up to 8.89 sec. Mono: up to 3.99 sec. (A4 size in 100 × 100 dpi)
Document Size	ADF Width: 89 mm to 216 mm ADF Height: 127 mm to 356 mm
Scanning Width	210 mm
Gray Scale	256 levels

 Mac OS[®] X scanning is supported in Mac OS[®] X 10.2.4 or greater.

Printer



For FAX-1840C, you can download the Brother Printer Driver from the Brother Solutions Center. Visit us at:

<http://solutions.brother.com>

Printer Driver	Windows® 98/98SE/Me/2000 Professional and XP driver supporting Brother Native Compression mode and bi-directional capability Apple® Macintosh® QuickDraw® Driver For Mac OS® 8.6-9.2/Mac OS® X 10.2.4 or greater
Resolution	Up to 1200 x 6000 dots per inch (dpi)* 1200 x 1200 dots per inch (dpi) 600 x 600 dots per inch (dpi) 600 x 150 dots per inch (dpi) <small>* Output image quality varies based upon many factors including but not limited to input image resolution and quality and print media.</small>
Print Speed	up to 20 pages/minute (Mono)* up to 15 pages/minute (Colour)* <small>* Based on Brother standard pattern. A4 size in draft mode. Does not include the time it takes to feed the paper.</small>
Printing Width	204 mm (216 mm*) <small>* When you set the Borderless feature to On.</small>
Disk-Based Fonts	35 TrueType
Borderless	Letter, A4, A6, Photo Card, Index Card, Post Card

Interfaces

USB

A Full-Speed USB 2.0 cable that is no longer than 2.0 m*

* Your machine has a Full-Speed USB 2.0 interface. This interface is compatible with Hi-Speed USB 2.0; however, the maximum data transfer rate will be 12 Mbits/s. The machine can also be connected to a computer that has a USB 1.1 interface.

Computer requirements

Minimum System Requirements					
Computer Platform & Operating System Version		Processor Minimum Speed	Minimum RAM	Recommended RAM	Available Hard Disk Space for Drivers
Windows® *1 Operating System	98, 98SE	Pentium II or equivalent	32 MB	64 MB	90 MB
	Me				
	2000 Professional		64 MB	128 MB	
	XP*2		128 MB	256 MB	150 MB
Apple® Macintosh® Operating System	Mac OS® 8.6 (Printing and PC-FAX Send*4 Only)	All base models meet minimum Requirements		64 MB	80 MB
	Mac OS® 9.X (Printing and PC-FAX Send*3 Only)				
	Mac OS® X 10.2.4 or greater		128 MB	160 MB	
NOTE: All registered trademarks referenced herein are the property of their respective companies.					

*1 Microsoft® Internet Explorer 5 or greater.

*2 Maximum 1200 x 1200 dpi scanning with Windows® XP. (Resolutions up to 2400 x 2400 dpi can be selected using the Brother Utility.)

*3 PC Fax supports black and white faxing only.

Consumable items

Ink

The machine uses individual Black, Yellow, Cyan and Magenta ink cartridges that are separate from the print head assembly.

Service Life of Ink Cartridge

Standard Black - Approximately 500 pages at 5% coverage

High Yield Black - Approximately 900 pages at 5% coverage

Yellow, Cyan and Magenta - Approximately 400 pages at 5% coverage

The above figures are based upon the following assumptions:

- Continuous printing at a resolution of 600 x 600 dpi in normal mode after installing new ink cartridge;
- The printing frequency;
- The number of pages printed;
- Periodic, automatic, print head assembly cleaning (Your machine will clean the print head assembly periodically. This process will use a small amount of ink); and,
- Ink remaining in cartridge identified as “empty” (It is necessary to leave a small amount of ink in the ink cartridge to prevent air from drying out and damaging the print head assembly).

Replacement Consumables

<Standard Black> LC47BK

<High Yield Black> LC47HYBK

<Cyan> LC47C

<Magenta> LC47M

<Yellow> LC47Y

Optional External Wireless Print/Scan Server (NC-2200w) (MFC-3240C only)

NC-2200w External Wireless Print/Scan Server (Optional)

Connecting the optional External Wireless Print/Scan Server (NC-2200w) to your machine will allow you to print and scan over a wireless network.

Network types

IEEE 802.11b wireless LAN

Support for

Windows® 98/98SE/Me/2000/XP
Mac OS® X 10.2.4 or greater

Protocols

TCP/IP
ARP, RARP, BOOTP, DHCP, APIPA (Auto IP),
WINS/NetBIOS, DNS, LPR/LPD, Port9100,
SMB Print, IPP, RawPort, mDNS, TELNET, SNMP,
HTTP



You can assign the scan key to one networked computer only.

Index

A

- Access codes, storing and dialling 5-6
- ADF (automatic document feeder) 1-7, 3-4
- Answering machine (TAD) ... A-18
 - connecting A-19
- Automatic
 - fax receive 4-1
 - Fax Detect 4-4, 4-5
 - fax redial 3-3
 - transmission 3-4

B

- Broadcasting 3-11
 - setting up Groups for 5-4

C

- Cancelling
 - Fax Forwarding 6-5
 - fax jobs in memory 3-10
 - jobs awaiting redial 3-10
 - Paging 6-5
- Cleaning
 - print head 10-13
 - printer platen 10-22
 - scanner 10-21
- CNG tones 1-18
- Connecting
 - external TAD A-18
 - external telephone A-17
- Consumable items S-8
- Control panel overview 1-2
- Copy
 - brightness 8-9
 - colour adjustment 8-13

- contrast 8-13
- default settings 8-12
- Enlarge/Reduce 8-4
- enter Copy mode 8-1
- keys 8-3
- multiple 8-2
- Page Layout 8-10
- paper 8-8
- Quality key 8-4
- quality setting 8-12
- single 8-2
- temporary settings 8-3
 - using ADF 8-2
- Cordless phone A-16
- Credit card numbers 5-6
- Custom telephone features
 - on a single line 10-11, A-21

D

- Date and Time 2-1
- Delayed Batch Transmission
 - 3-14
- Dialling
 - a pause 5-6
 - access codes and credit card numbers 5-6
 - automatic fax redial 3-3
 - automatic transmission 3-4
 - Groups 3-11
 - manual transmission 3-1
 - Speed-Dial 3-2
- Distinctive Ring A-3
- Document
 - jam 10-4
- Dual Access 3-8

E

- ECM
 - (Error Correction Mode) ... 1-19
- Envelopes 1-13
- Equalization 10-12
- Error messages on LCD ... 10-1
 - Comm. Error 10-1
 - Ink Empty 10-2
 - Near Empty 10-2
 - No Paper Fed 10-2
 - Not Registered 3-2, 10-2
 - Out of Memory 10-3
 - Unable to Change 10-3
 - Unable to Clean 10-3
 - Unable to Init. 10-3
 - Unable to Print 10-3
 - Unable to Scan 10-3
- Extension telephone,
 - usingA-14
- External telephone,
 - connectingA-17

F

- Fax codes
 - changing 6-3, A-16
 - Fax Receive CodeA-14
 - Remote Access Code6-3
 - Telephone Answer Code
 -A-14
- Fax Detect 4-4
- Fax Forwarding
 - changing remotely6-5, 6-6
 - programming a number 6-1
- Fax Storage 6-2
 - printing from memory 4-7
 - turning on 6-2
- Fax, stand-alone
 - receiving 4-1
 - at end of conversation ... 4-6
 - compatibility 10-12

- difficulties 10-9
- Fax Forwarding6-5
 - from extension phone ... A-14
 - reducing to fit on paper ...4-6
 - retrieving from a remote
 - site6-6
 - Ring Delay, setting4-2
- sending3-1
 - at end of conversation ...3-5
 - automatic3-4
 - Broadcasting3-11
 - cancelling from memory
 -3-10
 - colour fax3-4
 - compatibility10-12
 - contrast3-6
 - enter Fax mode3-1
 - from memory
 - (Dual Access)3-8
 - manual3-5
 - overseas3-12
 - Real Time Transmission
 -3-9
 - resolution3-7

- Fax/Tel mode
 - answering at extension
 - phones A-14
 - double-ringing
 - (voice calls)4-3
 - F/T Ring Time4-3
 - Fax Receive Code A-14
 - receiving faxes A-15
 - Ring Delay4-2
 - Telephone Answer Code
 - A-14
 - telephone calls A-15

G

- Gray scaleS-4, S-5
- Groups for Broadcasting5-4

H

- HELP
- LCD messages B-1
 - using navigation keys ... B-2
- Menu Table B-1, B-3
- Hold 5-8

I

- Ink cartridges
 - checking ink volume 10-17
 - replacing 10-23
- Ink Dot Counter 10-23

J

- Jacks
- EXT
 - external telephone A-18
 - TAD (answering machine)
..... A-18

L

- LCD (liquid crystal display)
..... B-1, B-2
 - contrast 2-8
- Help List 7-3

M

- Maintenance, routine 10-21
- Manual
 - dialling 3-1, 5-8
 - receive 4-1
 - transmission 3-5
- Memory Security 3-16, 3-19
- Memory Storage B-1
- Menu Selection Table B-1
- Mode, entering
 - Copy 8-1
 - Fax 3-1
 - Scan 1-3

- Multi-line connections (PBX)
..... A-21

O

- One-Touch numbers
 - storing 5-1
- Options key (copying)
 - Brightness 8-9
 - Paper Size 8-8
 - Paper Type 8-8

P

- Paging
 - programming your pager
number 6-1
- Paper 1-9, S-3
 - document size 3-4
 - Size 2-6
 - size of document 1-7
 - Type 2-6
- Phone line
 - connections A-19
 - difficulties 10-10
 - multi-line (PBX) A-21
 - set 2-3
- Power failure B-1
- Power Save key 1-5
- Print
 - area 1-13
 - difficulties 10-8, 10-9
 - drivers S-6
 - fax from memory 4-7
 - improving quality 10-13
 - paper jams 10-5
 - report 7-3
 - resolution S-6
 - specifications S-6
- Programming your MFC
..... B-1, B-2

Q	
Quality key (copying)	8-3
Quick-Dial	5-1
Access codes and credit card numbers	
setting up	5-6
Broadcasting	3-11
using Groups	3-11
Group dial	
changing	5-3
setting up Groups for Broadcasting	5-4
One-Touch dial	
setting up	5-1
using	3-2
Search	3-3
Speed-Dial	
changing	5-3
setting up	5-2
using	3-2

R	
Receive Mode	4-2
External TAD	4-1
Fax Only	4-1
Fax/Tel	4-1
Manual	4-1
Redial/Pause	3-3
Reducing	
copies	8-4
incoming faxes	4-6
Remote Retrieval	6-4
access code	6-3, 6-4
commands	6-5
getting your faxes	6-6
Reports	7-1
Fax Journal	7-3
Journal Period	7-2
Help List	7-3

how to print	7-3
Quick-Dial List	7-3
Transmission Verification	7-1
User Settings	7-3
XMIT Verify	7-3
Resolution	
copy	S-3
fax (Standard, Fine, SuperFine, Photo)	S-4
print	S-6
scan	S-5
setting for next fax	3-7
Ring Delay, setting	4-2

S	
Safety Instructions	ii, 9-2
Setup	
Date and Time	2-1
Station ID (fax header) entering text	2-2
Shipping the machine	10-18
Speed-Dial	
changing	5-3
dialling	3-2
storing	5-2

T	
TAD (telephone answering device), external	4-1, A-18
connecting	A-18, A-19
receive mode	4-1
recording OGM	A-20
Telstra® FaxStream® Duet ...	A-1
Temporary copy settings	8-3
Text, entering	B-3
special characters	B-10
Troubleshooting	10-1
checking ink volume	10-17
error messages on LCD ...	10-1

if you are having difficulty with	
copying	10-11
incoming calls	10-11
phone line	10-12
phone line difficulties ...	10-10
printing	10-8
Printing Received	
Faxes	10-9
receiving faxes	10-10
scanning	10-11
sending faxes	10-10
software	10-11
paper jam	10-5
print quality	10-13
TX Lock	3-17

V

Volume, setting	2-7
beeper	2-7
ring	2-7
speaker	2-8

Remote Retrieval Access card

If you plan to receive fax messages while away from your machine, carrying the Remote Retrieval Access Card printed below will serve as a convenient reminder of the retrieval procedures. Simply cut out the card and fold it to fit your wallet or organizer. Keeping it handy will help you derive the full benefit of your machine's Paging, Fax Forwarding, and Remote Retrieval features.

REMOTE RETRIEVAL ACCESS CARD

CHECK RECEIVING STATUS
Press **9 7 1**
1 long beep — Fax messages
3 short beeps — No messages

CHANGE RECEIVE MODE
Press **9 8**
then for External TAD, press **1**.
Fax/Tel, press **2**.
Fax Only, press **3**.

EXIT REMOTE OPERATION
Press **9 0**.

Using Remote Access Code

- 1** Dial your fax number from a telephone or fax machine using touch tone.
- 2** When your machine answers, immediately enter your Remote Access Code (3 digits followed by *).
- 3** Your machine signals the kinds of messages it received:
1 long beep — Fax messages
No beeps — No messages.
- 4** After 2 short beeps, enter a command.
- 5** Press **9 0** to reset your machine when you finish.
- 6** Hang up.

Fold ← → Fold

Changing Remote Access Code

- 1 Press Menu/Set, 2, 5, 3.
- 2 Enter a three-digit number from 000 to 999. The * cannot be changed.
- 3 Press Menu/Set.
- 4 Press Stop/Exit.

Remote Commands

CHANGE FAX FORWARDING SETTING

- Press 95.
then to Turn feature Off, press 1.
Select Fax Forwarding, press 2

Fold

Program Fax Forwarding Number: press 4. Enter the new fax number where you want your fax messages forwarded followed by ##.
Turn Fax Storage On, press 6.

RETRIEVE FAX

- Press 96
then to Retrieve all faxes, press 2
then enter the number of remote fax machine followed by ##
After the beep, hang up and wait.
Erase all fax messages, press 3.

Fold

At your side.
brother®

Visit us on the World Wide Web
<http://www.brother.com>

This machine is approved for use in the country of purchase only, local Brother companies or their dealers will only support machines purchased in their own countries.



ARL/ASA/NZ
LF7537001