

Panasonic

1億人のファクス

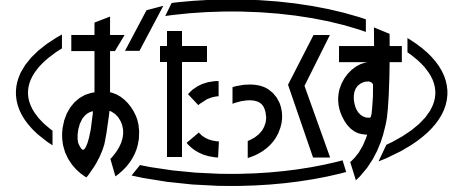

Facsimile with Cordless Phone



Quick Reference Guide

Model No. **KX-PW76CL**

Table of Contents

Finding the Controls	2
Set up	4
Connections	4
Recording paper	6
Setting date and time	8
Setting your facsimile telephone number.....	8
Setting your logo	9
Telephone Operations	10
Facsimile Operations	11
Setting the Answer Mode	14
Answering Device Functions	15
Using E-mail	16
Using Hand Scanner.....	20
Specifications	Back cover

Finding the Controls

Main unit

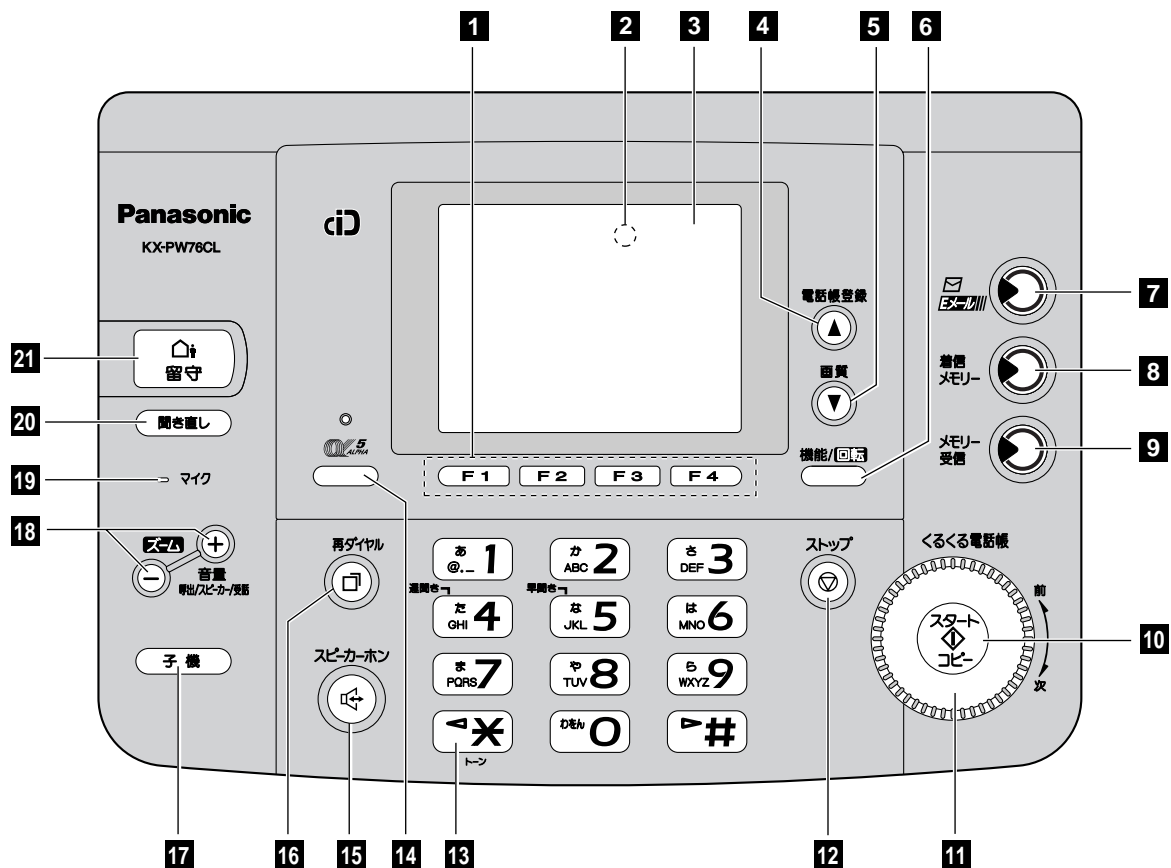

- 1 Multi-operation** buttons refer to the function displayed on the display panel.
- 2 Reset** key
- 3 Liquid crystal display**
- 4 Store** button stores information (phone numbers, names etc.) into the telephone directory.
Scroll button scrolls display contents up.
- 5 Resolution** button selects the resolution when faxing or copying.
Scroll button scrolls display contents down.
- 6 Function** button initiates programming.
Revolution button turns display contents 90° clockwise.
- 7 E-Mail** button
- 8 Call Memory** button & indicator store the caller ID of incoming calls.
- 9 Memory** button & indicator store received fax and e-mail data.
- 10 Start/Copy** button starts faxing or copying.
- 11 Search Dial** searches the directory or displays programming features.
- 12 Stop** button
- 13 Tone** button switches to tone dialing.
- 14 α-ALPHA5** button accesses α5 services.
- 15 Speakerphone** button
- 16 Redial/Pause** button
- 17 Intercom** button
- 18 Volume** buttons adjust ringer, speaker and handset volume.
Zoom buttons enlarge or reduce display contents.
- 19 Microphone**
- 20 Replay** button listens to recorded messages.
- 21 Auto Answer** button
—light on: answering device activated.
—light off: used as a telephone.

Portable Handset

Display
displays battery strength, telephone numbers etc.

(ex) 子機 1
プライベートかな

子機 1 Handset number (Handset 1)
プライベート Displayed when receiving private message or fax.
英 Displayed when entering characters for the telephone directory.

In use/charge indicator
When receiving a call flashes red
When charging lights red
When charging complete lights green

外線 To make/answer calls.

切 To end call.
To end storing and other operations.

かな/英
内線 To page the main unit.
To change the enter mode.

音量
To adjust the volume.

変換
To change Hiragana into Kanji.

キャッチ/クリア
For Call Waiting Service users.
To clear letters/numbers.

登録/修正・確定
To store names and telephone numbers in the search dial.
To edit/delete names and telephone numbers in the search dial.
To set quick call.

再ダイヤル
To radial the last number dialed.
To insert a pause.

着信メモリー
To put a call on hold.
To start the search for telephone numbers when using Number Display Service.

機能
To make the handset ring first.
To operate the answering device.
To use the private message and fax features.

ファクス
To receive faxes.

スピーカーホン
To use the speakerphone.

○ 増設
Used when installing additional handsets.

Hand Scanner

Memory indicator
(To show the amount of memory being used)

Delete button
(To delete the scanning contents)

Operation indicator
(Shows the condition of the scanner)

Battery indicator
(Shows the amount of battery power left)

Resolution switch

Scanning width switch

Setup (Connections)

Charge the Handset Battery

1 Connect AC adaptor to the Charger.

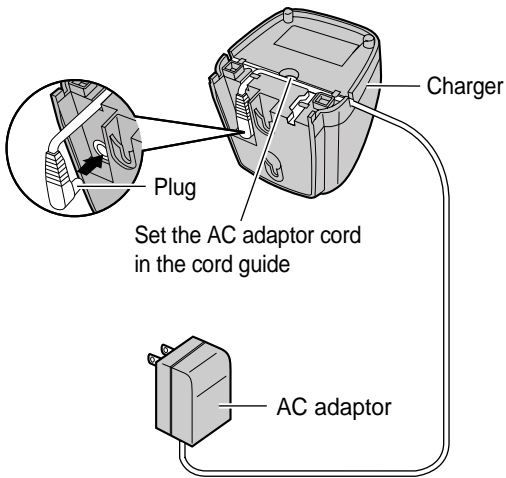

2 Connect the battery to the Handset.

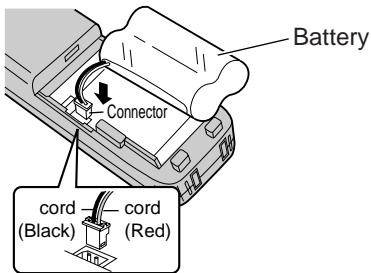

Put the cord away near the battery

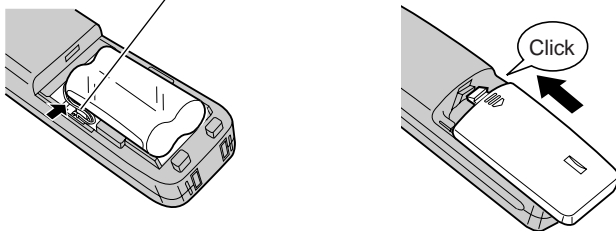

3 Charge the Handset Battery.

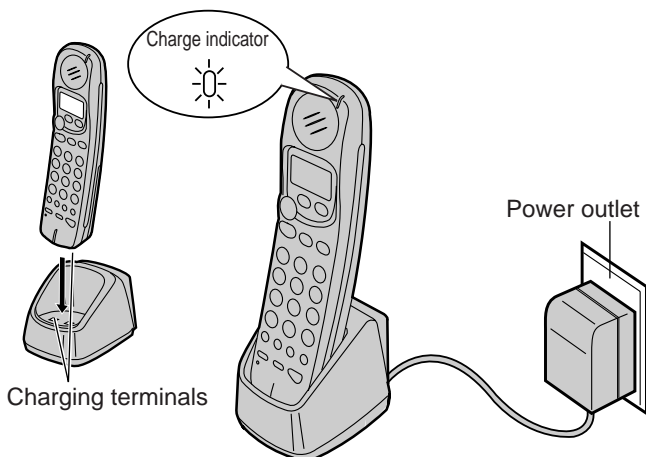

Insert the Recording paper sub-tray and Recording paper arm-spring in the main unit

1 Insert the Recording paper sub-tray.

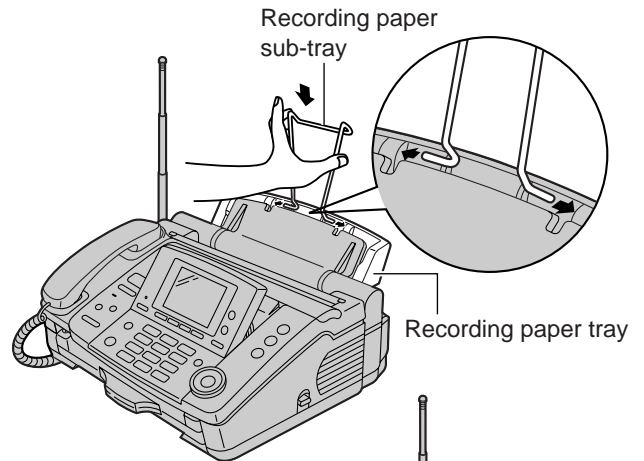

2 Insert the Recording paper arm-spring.

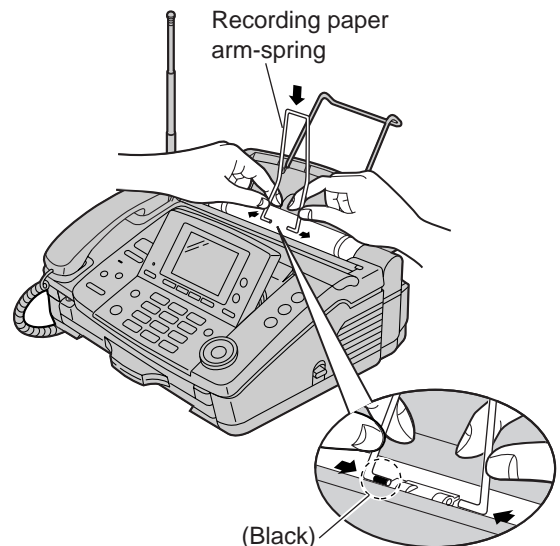

3 Throw down the Recording paper arm-spring.

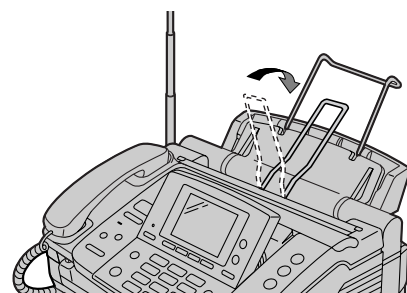

Connect the main unit

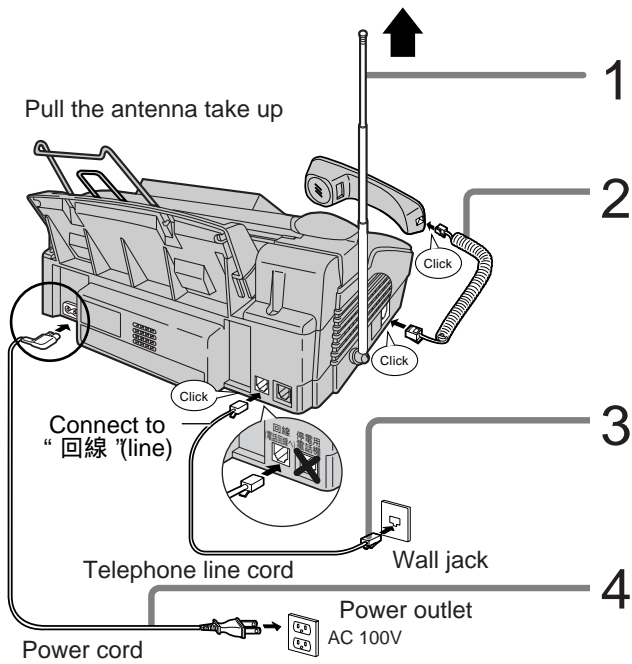

Telephone line selection (pulse or tone) will start automatically.

Charge the Hand scanner battery

1 Pull out the Hand scanner.

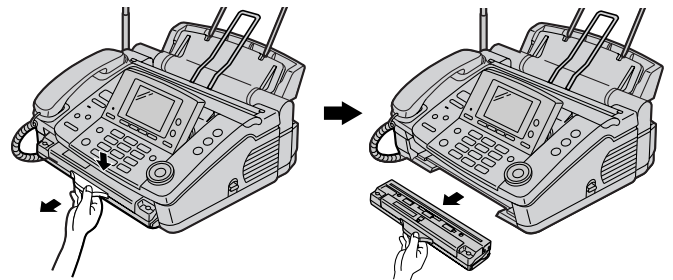

2 Slide open the battery cover by slightly pushing part.

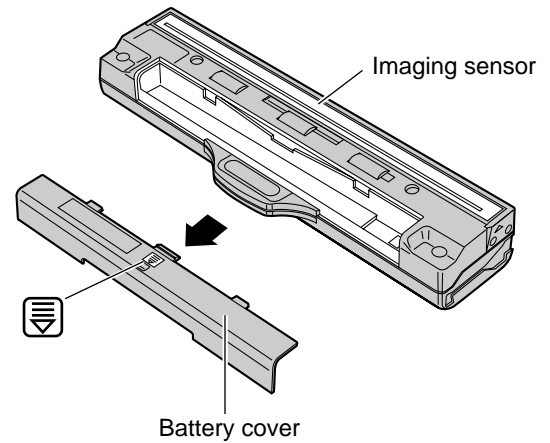

3 Connect the battery to the Hand scanner.

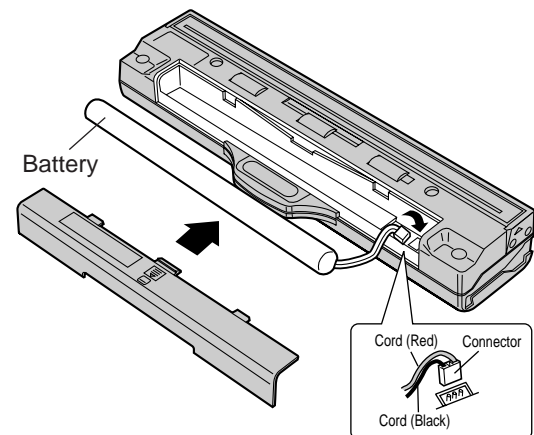

4 Insert the Hand scanner.

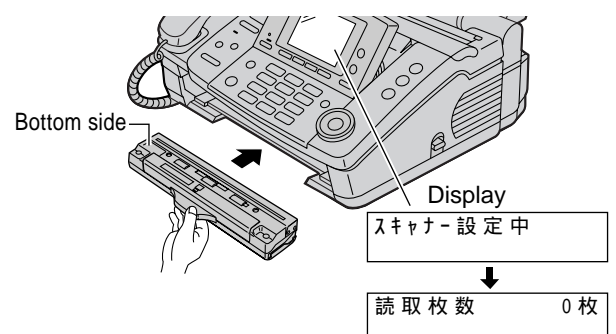

Setup (Recording paper)

Installing the Plain paper

- 1** Open the Control panel by pressing down the Control panel open button.

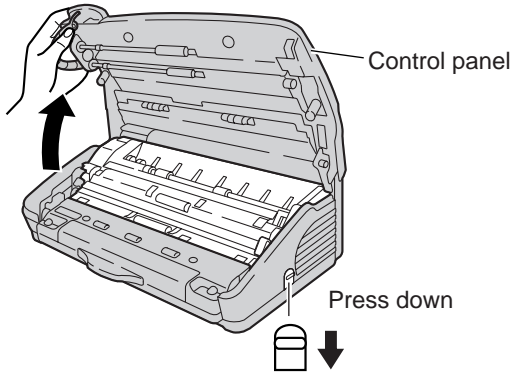

- 2** Open the Inner cover by sliding down the Inner cover open lever.

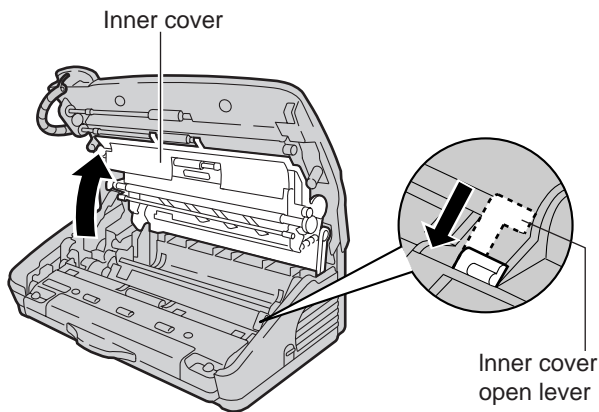

- 3** Prepare the Film cassette.

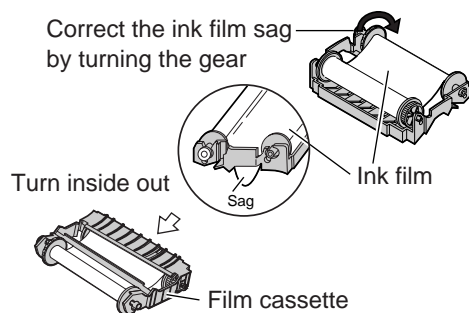

- 4** Put the Film cassette in the Main unit.

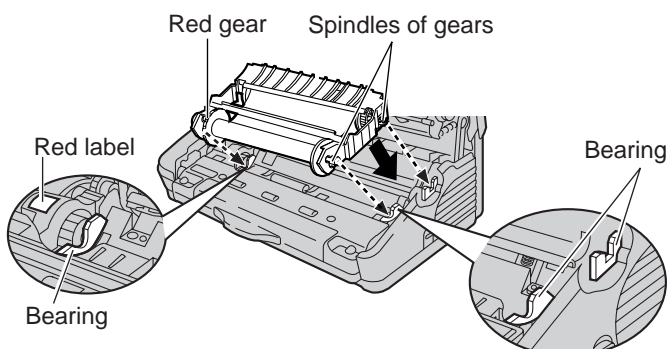

- 5** Close the Inner cover.

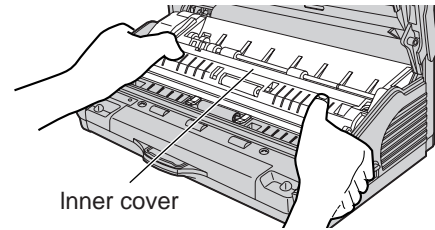

- 6** Close the Control panel and open the Recording paper cover.

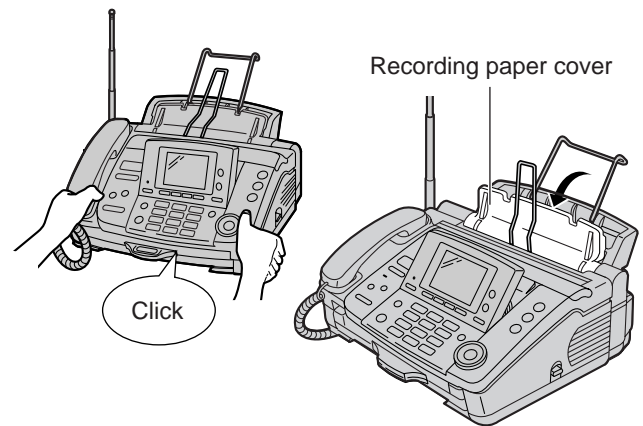

- 7** Fan the stack of paper to prevent a paper jam, and then insert the paper.

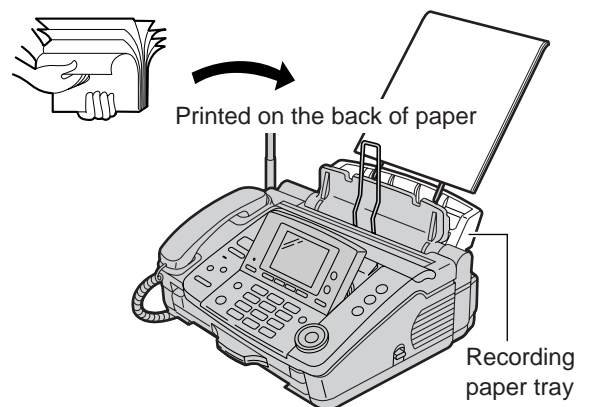

- 8** Throw down the Recording paper cover and Recording paper arm-spring.

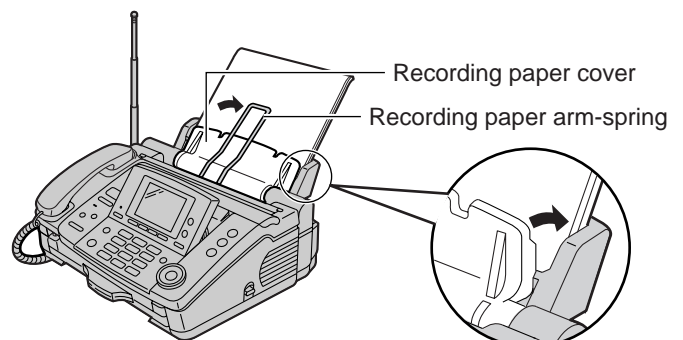

Installing the Thermal paper

- 1 Open the Control panel by pressing down the Control panel open button.

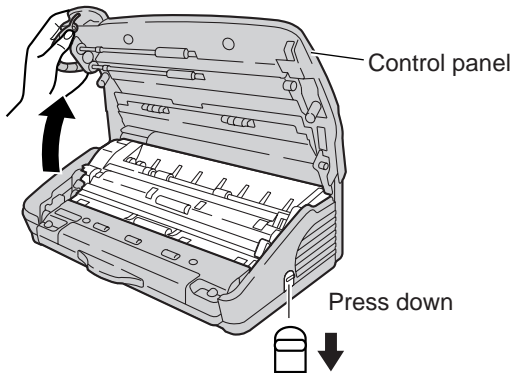

- 2 Open the Inner cover by sliding down the Inner cover open lever.

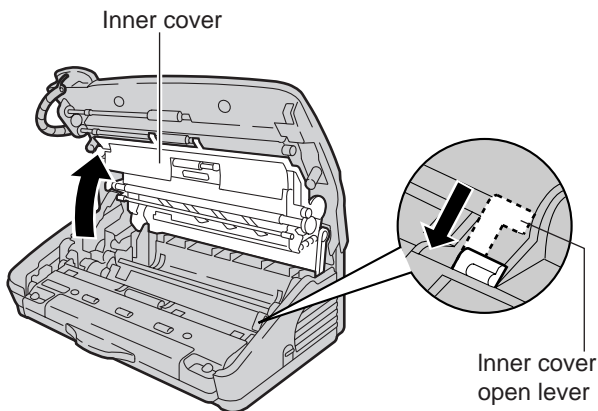

- 3 Put the Thermal paper to the Paper holder by spreading the Paper holder.

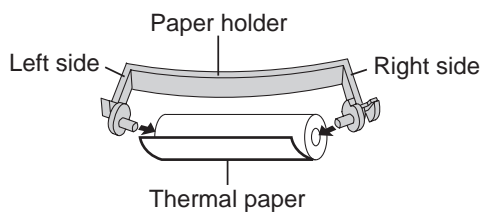

Correct

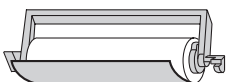

Incorrect



Slack

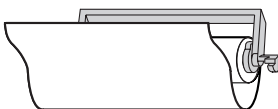

If the thermal paper has a slack, tighten it by winding.

- 4 Put the Paper holder in the set position of the Main unit.

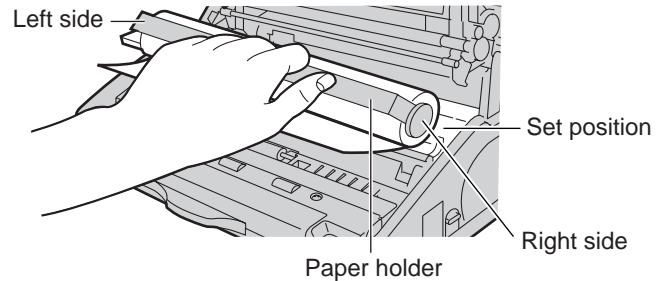

- 5 Insert the Thermal paper to the slit of Inner cover.

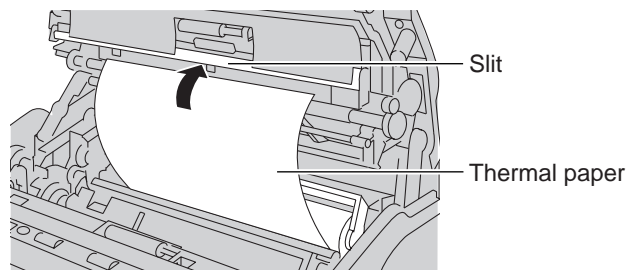

- 6 Close the Inner cover and pull out the thermal paper (approx. 5cm) through the outlet for recording paper.

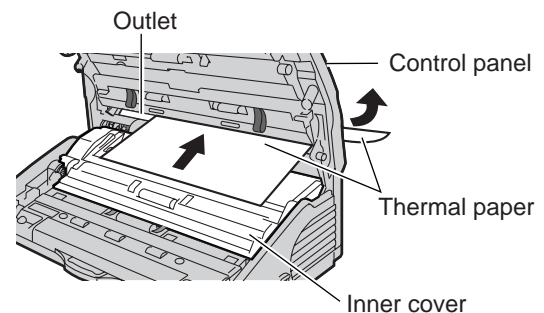

- 7 Close the Control panel

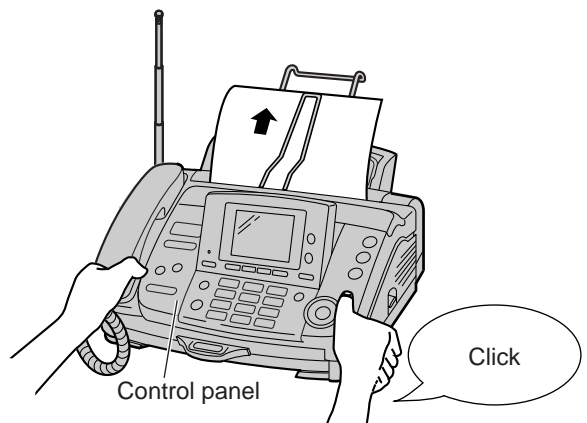

Setup (Setting date and time, your facsimile telephone number and logo)

You can program the date and time, your facsimile telephone number and logo.
This information will be printed on each page transmitted from your unit.



Setting date and time

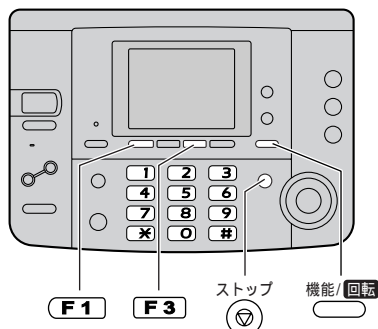

1 Press **機能/回転** and then press **#0001**.

日付時刻
2000年 01月 01日
00:00
クリア 登録
Cursor

2 Enter the correct year/month/day/time, using dial keypad.

Example: Mar. 10, 2000 15:45

Press **20000031001545**

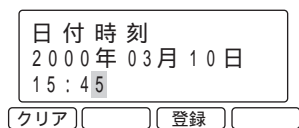

- To correct a mistake
 1. Press ***** or **#** to move the cursor to incorrect character/number.
 2. Press **クリア** **F1** and reenter.

3 Press **登録** **F3**.

登録しました

4 Press **ストップ**.

3月10日(金)
15:45
操作案内 スキャナー 留守電 ファクス一覧

Setting your facsimile telephone number

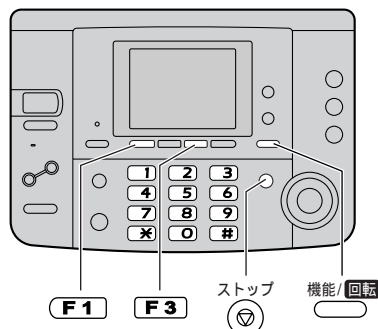

1 Press **機能/回転** and then press **#0004**.

電話番号?
.....
クリア 登録
Cursor

2 Enter your facsimile telephone number, up to 20 digits, using the dial keypad.

- To correct a mistake, press **クリア** **F1** and reenter.



If you want to enter space, press **音量 -**.

3 Press **登録** **F3**.

登録しました

4 Press **ストップ**.

3月10日(金)
15:45
操作案内 スキャナー 留守電 ファクス一覧

Telephone Operations

1

Making/Answering voice calls

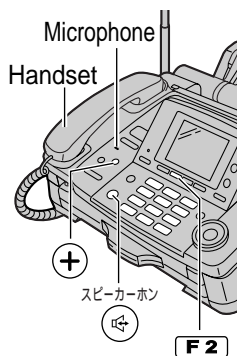

Making calls

1. Lift the handset or press (speakerphone).
2. Dial the telephone number.
3. Talk to the other party.
4. When finished, replace the handset or press (speakerphone).

Answering calls

1. When the phone rings, lift the handset or press (speakerphone).
2. Talk to the other party.
3. When finished, replace the handset or press (speakerphone).

Note:

When a slow beep or no sound is heard, press (start/copy) and replace the handset.

The unit will start fax reception.

2

Automatic dialing

Main unit

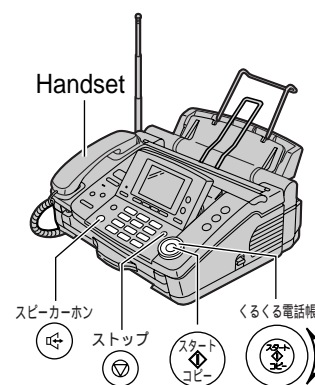

Automatic dialing with the main unit

1. Rotate (search dial) until the name you want to dial appears on the display.
2. Lift the handset or press (speakerphone).
3. Talk to the other party.
4. When finished, replace the handset or press (speakerphone).

Portable handset

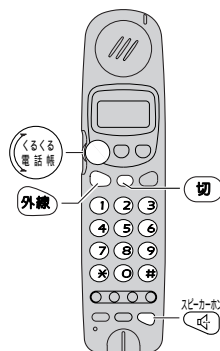

Automatic dialing with the portable handset

1. Rotate (search dial) until the name you want to dial appears on the display.
 - If the name has not been stored, press (end) and store the name, or dial the number manually.
2. Press (outside line) or (speakerphone).
 - ➔ The number will be dialed.
 - The last 12 digits (including spaces) will be displayed.
3. Talk to the other party.
4. When finished, press .



Storing a phone number in the main unit

1. Press (telephone directory store/edit).
2. Enter the station name, up to 12 characters, using the dialing buttons.
3. Press .
4. Enter the phone number up to 30 digits.
5. Press .
 - To program other stations, repeat from step 2.
6. Press .
7. Enter the group number (1-9).
8. Press .

Storing a phone number in the portable handset







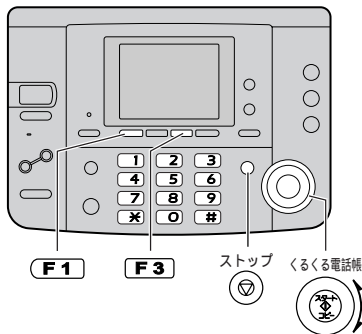

1. Press (store/edit/decide).
 - xx will show how many items can still be stored.
2. Use the dial buttons to enter the desired name, up to 12 characters.
 - If you do not want to store a name, go to step 3.
3. Press .
4. Use the dial buttons to enter the phone number, up to 30 digits.
 - Press (volume) to insert a space.
 - If you enter a wrong number, press (clear).
 - If you enter 12 or more digits (including spaces), numbers will disappear from the screen from the left.
5. Press (store/edit/decide).
 - To enter a 2nd or 3rd number, repeat from step 4.

Facsimile Operations

6. Press  (store/edit/decide).
 - If you do not want to enter a group number, go to step 8.
(If a group number is not entered, the numbers will be stored in group 1.)
7. Enter a group number (1-4) if required.
8. Press  .
 - To continue storing, repeat from step 2.
 - To end storing, press  (end).

Changing a stored name or number



1. Rotate  (search dial) until the name you want to change appears on the display.
2. Press  .
3. Press  or  to move the cursor to the incorrect character, and make the correction.
4. Press   .
5. Enter the correct phone number.
6. Press  .
7. Press  repeatedly until the group number is displayed.
Example: Group number=1

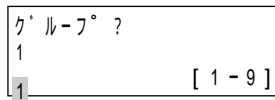



8. Enter the correct group number.
9. Press  .

1

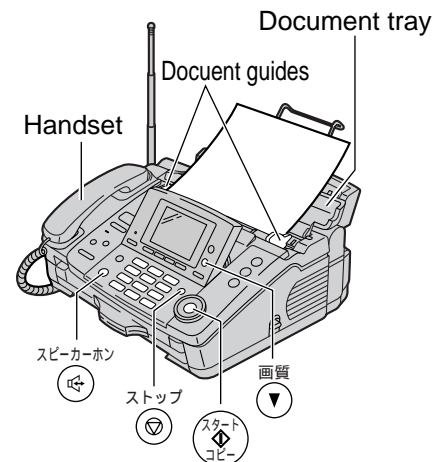
Sending documents



Sending documents manually



1. Open the document tray and adjust the document guides.
2. Insert the document FACE DOWN until a beep is heard (up to 5 sheets at a time).
3. Press  (resolution) to select the resolution.
4. Lift the handset or press  (speakerphone).
5. Dial the fax number.
6. When a fax tone is heard, press  (start/copy).
7. Replace the handset.
 - The unit will start fax transmission.

Selecting the resolution

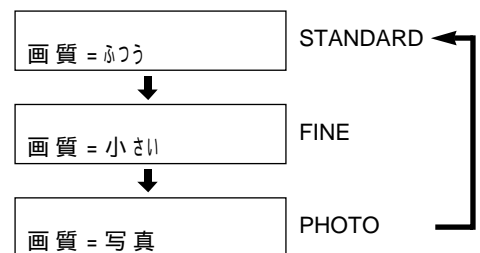
Press  (resolution).



Sending documents using automatic dialing



1. Open the document tray and adjust the document guides.
2. Insert the document FACE DOWN until a beep is heard (up to 5 sheets at a time).
3. Press  (resolution) to select the resolution.
4. Rotate  (search dial) until the name you want to send documents appears on the display.
5. Press  (start/copy).
 - The unit will start fax transmission.

Facsimile Operations

2

Receiving documents

With this unit, you can choose beforehand whether to receive faxes by “Receive in memory” or “Receive on recording paper”.

	How to use	How the memory indicator works (Changes each time it is pressed)
Receive in memory (Default Setting)	The received fax will be stored in memory. You can check the contents on the display and print out the necessary information only.	メモリー受信  LIGHT
Receive on recording paper	The received fax will be printed on recording paper. (When a fax is received, the unit will start printing after correspondence is completed.)	メモリー受信  OFF

Display when fax is received in memory

FLASHES

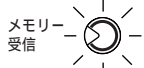

(Flashing will stop after all new faxes have been displayed or printed out.)

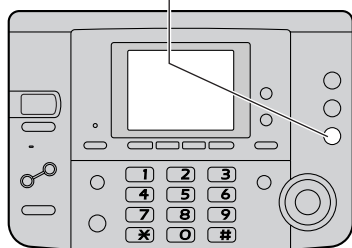

Display the number of faxes stored in memory



Shows that a new fax has been stored in memory.

Scroll pages (Example : Documents consists of 3 pages.)

To show the next page, turn to the right.

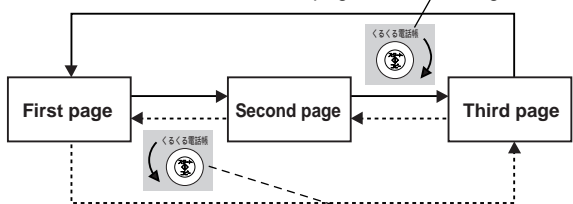

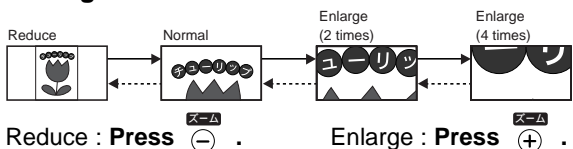

To show the previous page, turn to the left.

To enlarge or reduce content

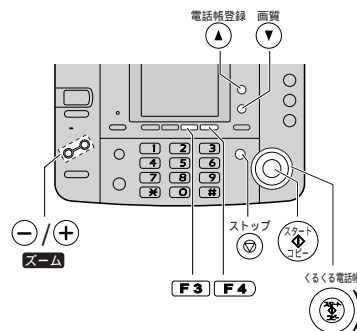

Retrieve faxes stored in the memory



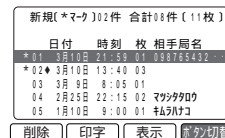

1. When the unit is stand-by mode, press  **F4**



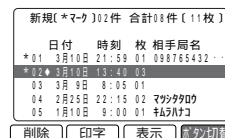

2. Press  or  to choose the desired fax to display.



3. Press  **F3** to see the fax (see below for information about the display).



• To print out the displayed page, press  .



4. To see other faxes, press  **F4** and continue from step 2 again. To go back to the stand-by mode, press  .

To scroll to the display

To scroll right : Press  **F4** . To scroll left : Press  **F3** .

To scroll above : Press  . To scroll below : Press  .

• Normal display (Can be scrolled above and below)



• Enlarge display (Can be scrolled above, below to the left and right.)



Printing a specific fax stored in the memory

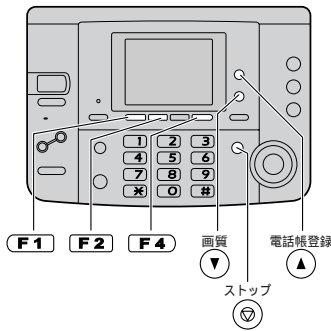

1. When the unit is stand-by mode, press **F4** .

新規(メモ)02件 合計08件 (11枚)				
日付	時刻	枚	相手局名	
*01	3月10日 21:59 01	098765432		
02	3月10日 13:40 03			
03	3月 8日 8:05 01			
04	2月25日 22:15 02	マツタケ00		
05	1月10日 9:00 01	私57473		

削除 印字 表示 転写切替

2. To choose the desired fax that you want to print out, press **画質** or **電話帳登録** .

新規(メモ)02件 合計08件 (11枚)				
日付	時刻	枚	相手局名	
*01	3月10日 21:59 01	098765432		
02	3月10日 13:40 03			
03	3月 8日 8:05 01			
04	2月25日 22:15 02	マツタケ00		
05	1月10日 9:00 01	私57473		

削除 印字 表示 転写切替

3. Press **印字** **F2** to see the fax.
 • The fax will be printed out.

After print out the fax, displayed following.

Do you delete the printed contents ?

印字した内容を
すへて削除しますか?
はい いいえ

4. If you want to delete the fax, press **はい** **F1** .

削除しました

If you want to hold the fax, press **いいえ** **F4** .

新規(メモ)02件 合計08件 (11枚)				
日付	時刻	枚	相手局名	
*01	3月10日 21:59 01	098765432		
02	3月10日 13:40 03			
03	3月 8日 8:05 01			
04	2月25日 22:15 02	マツタケ00		
05	1月10日 9:00 01	私57473		

削除 印字 表示 転写切替

5. Press **ストップ** .

• Displayed date and time.

Printing a specific fax stored in the memory

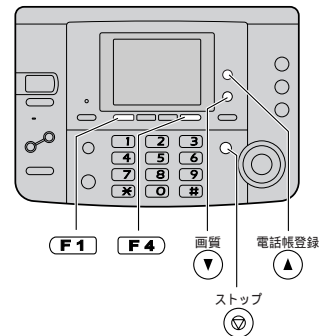

1. When the unit is stand by mode, press **F4** .

新規(メモ)02件 合計08件 (11枚)				
日付	時刻	枚	相手局名	
*01	3月10日 21:59 01	098765432		
02	3月10日 13:40 03			
03	3月 8日 8:05 01			
04	2月25日 22:15 02	マツタケ00		
05	1月10日 9:00 01	私57473		

削除 印字 表示 転写切替

2. To choose the desired fax that you want to delete, press **画質** or **電話帳登録** .

新規(メモ)02件 合計08件 (11枚)				
日付	時刻	枚	相手局名	
*01	3月10日 21:59 01	098765432		
02	3月10日 13:40 03			
03	3月 8日 8:05 01			
04	2月25日 22:15 02	マツタケ00		
05	1月10日 9:00 01	私57473		

削除 印字 表示 転写切替

3. To delete the fax, press **削除** **F1** .

Do you delete the fax ?

印字した内容を
すへて削除しますか?
はい いいえ

or

Do you delete the new fax ?

削除しますか?
新規の内容があります
はい いいえ

4. If you want to delete the fax, press **はい** **F1** .

削除しました

If you want to hold the fax, press **いいえ** **F4** .

新規(メモ)02件 合計08件 (11枚)				
日付	時刻	枚	相手局名	
*01	3月10日 21:59 01	098765432		
02	3月10日 13:40 03			
03	3月 8日 8:05 01			
04	2月25日 22:15 02	マツタケ00		
05	1月10日 9:00 01	私57473		

削除 印字 表示 転写切替

5. Press **ストップ** .

• Displayed date and time.

Setting the Answer Mode

This unit has five Answer modes. Choose the desired mode according to your needs. Press (auto answer) to switch between manual answer and auto answer modes.

1 Manual answer mode

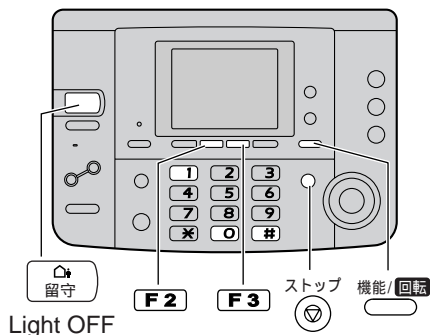

Telephone mode (電話優先)

When you want to answer all calls manually. After answering the call, press the start button for fax reception.

Facsimile/Telephone mode (FAX 優先)

When you want to answer voice calls but do not want to be disturbed by fax calls. If no one answers the call, the unit will receive the documents automatically. Or you can answer the call and press the start button for fax reception.

1. Press , and then press **#1110** .

在宅時の受けかた
ファクス優先

or

在宅時の受けかた
電話優先

2. Press (select) to select the Telephone mode (電話優先) or Facsimile/Telephone mode (ファクス優先).
3. Press (register).
4. Press (stop).

2

Auto answer mode

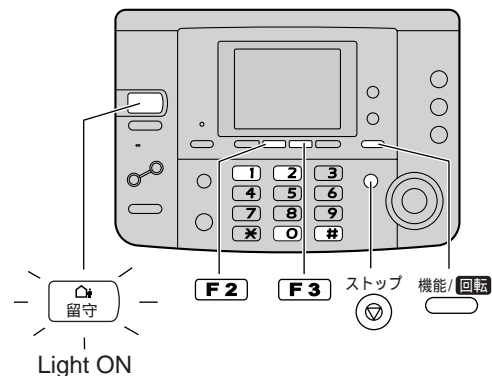

Answering machine/Facsimile mode (FAX/留守電)

When you want to use the unit to record voice messages and receive documents.

When a call is received, the unit plays your greeting message and records the voice message.

If a fax is detected, the unit receives the documents automatically.

Facsimile mode (FAX 専用)

When you want to use the unit solely as a fax machine.

The unit receives documents automatically. You cannot answer voice calls and the answering device will not function.

Answering machine mode (留守電専用)

When you want to use the unit to record voice messages only.

The unit will not receive documents automatically.

1. Press , and then press **#1200** .

留守時の受けかた
ファクス専用

or

留守時の受けかた
留守電専用

or

留守時の受けかた
ファクス/留守電

2. Press (select) to select the Facsimile mode (ファクス専用) or Answering machine mode (留守電専用) or Answering machine/Facsimile mode (ファクス/留守電).
3. Press (register).
4. Press (stop).
5. Press (auto answer).

Light ON

Answering Device Functions

1 Recording your own greeting message



- Press **F3** (留守電).
- Rotate **くるくる電話帳** until the following is displayed.

応答録音
受話器を取って下さい
- Lift the handset.

応答録音
録音開始はスタート
- Press **スタート コピー** (start/copy).
Record your greeting message up to 16 seconds.
- Press **ストップ** (stop) and replace the handset.
– The greeting message will be played back once automatically.

2 Erasing the greeting message

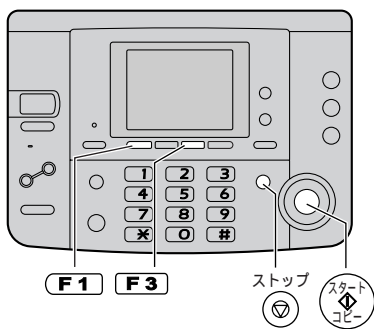

- Press **F3** (留守電).
- Rotate **くるくる電話帳** until the following is displayed.

応答消去
[くるくる, スタート]
- Press **スタート コピー**.

消去しますか?
- Press **はい F1**.

応答消去
しばらくお待ちください

↓

応答消去
消去しました

3 Setting up the automatic answering device

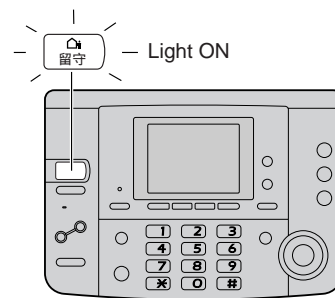

- Press **留守** (auto answer). Light ON
- To cancel the automatic answering device mode, press **留守** (auto answer) again. Light OFF

4 Listening to recorded messages

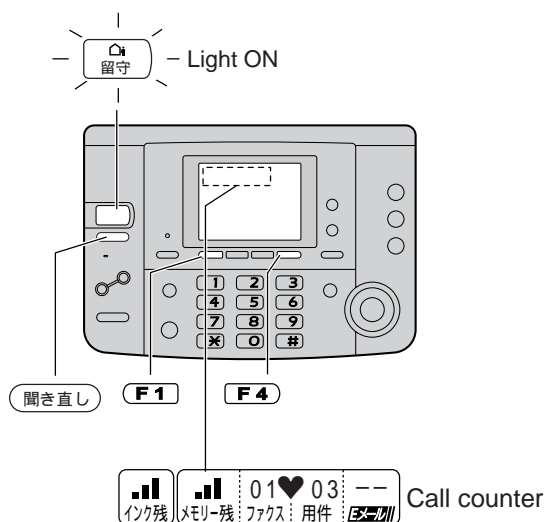

- Press **留守** (auto answer) or **聞き直し** (replay). Light ON

5 Erasing recorded messages

To erase all the recorded messages

- Press **F3** (留守電).
- Press **スタート コピー** (start/copy).
- Press **はい F1**.

応答消去
しばらくお待ちください

↓

応答消去
消去しました

To erase a specific message

- Press **F1** (erase) while listening to the message you want to erase.
- Press **はい F1**.

1

How to Subscribe

Send the enclosed “ -ALPHA5 · FAX service application form” to DDI Central Office by fax.
 FAX number: 0077-2322-9555 (24 hours)

This application form must be completed for use of -ALPHA5 (Not required if application was made at place of purchase).

The image shows a form titled 'DDI 中央事務センター' (DDI Central Office) for 'FAX送信方向' (FAX transmission direction). It includes fields for 'お申込日' (Application date), 'お名前' (Name), 'ご住所' (Address), and 'お申込み電話番号' (Application telephone number). There are also checkboxes for '必要' (Required) and '不要' (Not required).

How to fill in the form

Fill in your name, address and telephone number.

The detailed call charge list is available free of charge.
 If you wish to receive the list, circle ①.
 If not, circle ②.

The layout of the application form may change.

Note

- If you use NTT's dialin or double number service, register your contract number with DDI.
- **Please contact DDI Customer Service Center in the following situations**
 - If you are already using DDI.
 - If you are using another telephone company (including local companies) other than NTT.
 - If you are using a discount service with NTT or another telephone company (including local companies).

2

Make sure the -ALPHA5 indicator light is green, fill in the application form and send it by fax.

1. Filling in the application form.

The image shows a Panasonic form titled 'おたたくす情報サービス ご利用申込書' (DDI International Information Service Application Form). It includes fields for 'お申込み日' (Application date), 'お名前' (Name), 'ご住所' (Address), and 'お申込み電話番号' (Application telephone number). There are also checkboxes for '必要' (Required) and '不要' (Not required).

Fill in your name. Fill in your telephone number.
 Fill in your address.

- Use the name of the person registered with DDI.
 The layout of the application form may change.

2. Follow the procedure for “User Registration”.

3. The unit will automatically connect to the e-mail server and transmit the necessary information for registration.

4. When communication is complete, a report, as below, will automatically be printed out.

➡ Please check that the registered telephone number is correct.

(ex)

The image shows a printed report with the text: '1999. 3.10 14:30' and 'あなたの登録した電話番号は 0876543... です' (Your registered telephone number is 0876543...).

Your registered telephone number is 0876543...

3

How E-mail works

Using this unit, you can exchange E-mail with personal computer users all over the world. You can send or receive messages using the server's "mail box".

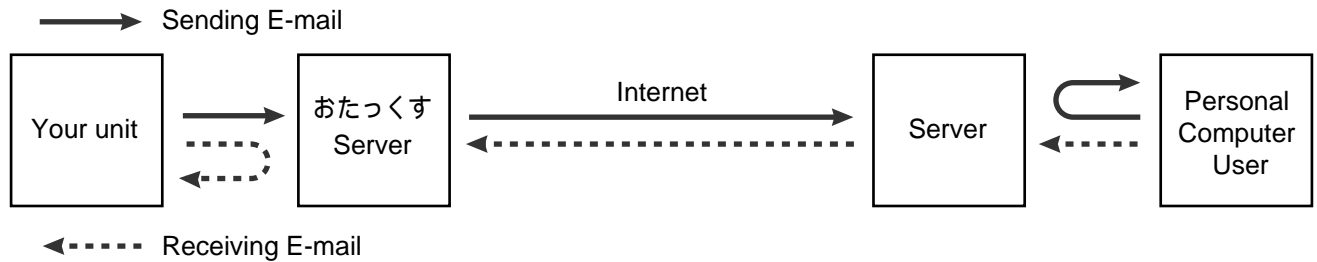

- When you register with おたっくす Information Service, the following E-mail address (example) will be supplied.

p X X X X Δ Δ Δ Δ @ fem.dion.ne.jp

User name: Personal number supplied by Kyushu Matsushita Electric.	Domain name: Common number to おたっくす Information Service users.
------------------------------------------------------------------------------------	--------------------------------------------------------------------------------

4

Before using this feature

- You have to register with DDI “ -ALPHA5” and Kyushu Matsushita Electric’s “おたっくす Information Service”. (See “1, 2” on page 16.)

- **Charges:**

Registration fee	¥500 (tax not included)
Call fee	¥10 per 1 minute (8:00am–11:00pm) ¥8.5 per 1 minute (11:00pm–8:00am)
Information service fee	¥5 per 30 seconds

You can do the following! (Telephone charges and information charges applicable)

- **Fax e-mail transmission :** You can send a fax as an e-mail message to a PC (with TIFF viewer) or おたっくす fax machine (data will be in TIFF format).
- **E-mail text transmission :** You can send e-mail messages entered using the dial buttons (data will be sent in text format).
- **E-mail reception :** You can print out e-mail messages (If there are no messages, you will only be charged for the telephone call).

- **E-mail not yet downloaded :** You can print out information about e-mails which have not yet been downloaded (telephone call charge only).
- **Checking number of e-mails not yet downloaded :** At pre-set intervals you can automatically connect to the server and check the number of e-mails. (You will only be charged for the telephone call. However if you receive e-mail at the same time, an information charge will be applicable.)
- **Extension functions :** You can carry out each operation following the voice guidance. New services planned for the future.
- **Storing e-mail addresses :** You can store frequently used e-mail addresses (no charge). Up to 30
- **Storing domain names :** You can store frequently used domain names (no charge). Up to 10

5 Registering with -ALPHA5

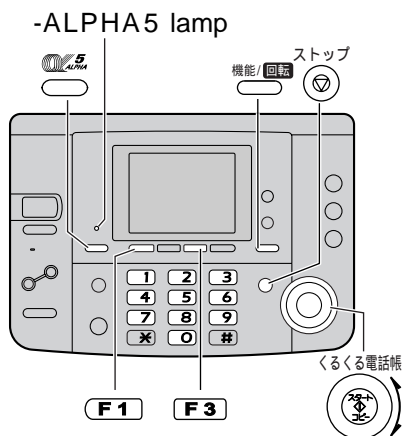

- Fill in the “-ALPHA5, -FAXサービス利用申込書” application form and fax it to 0077-2322-9555. (See “1” on page 16.)
- Register your telephone number and tip code as follows.
 - Press (function), then press .
 - Enter your postal code.
 - Press (register).
 - Press .
- 1 minute later, the fax machine will automatically dial to DDI.
 - 2 or 3 weeks later, the -ALPHA5 indicator will light up green.

6 Registering at おたっくす Information Service

Make sure the -ALPHA5 indicator light is green.

- Fill in the “おたっくす情報サービス利用申込書” application form. (See “2” on page 16.)
- Press (function), then press (E-mail).
- Press (start/copy).
 - The display will show the telephone number that has been registered at -ALPHA5.
- Press (start/copy).
- Set the application form on the fax machine.
- Press (start/copy).
- 5 minutes later, a bell will ring and data communication will automatically start.
 - If you have another call during data communication, hang up and wait for a while.
- After the data communication, a user registration guide will be sent from the E-mail server.
 - Please write down the E-mail address and security code sent from the server on the back cover of the operating instructions so as not to forget them.

7 Sending fax documents by E-mail

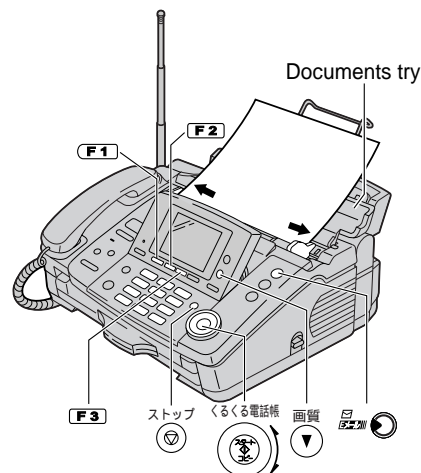

- Open the document tray and adjust the document guides.
- Insert the document FACE DOWN until a single beep is heard and select the resolution.
- Press (E-mail), and then press (start/copy).
- Enter the required E-mail address.
 - Refer to the character list on page 9.
- Press (start/copy).
- Enter the title (32 characters max.).
 - Refer to the character list on page 9.
- Press (start/copy).









Note:

- To send E-mail to an address stored in memory (see “8” on page 19), perform steps 1 to 3 above, then follow these steps:

- Rotate until the name you want to send to is displayed.
- Press (confirm).

8

Storing E-mail addresses

1. Press  (function), and then press .
2. Rotate  (search dial) until the message “アドレス帳登録” is displayed.
3. Press  (start/copy).
4. Enter the name up to 12 characters.
 - Refer to the character list on page 9.
5. Press  .
6. Enter the E-mail address up to 60 characters.
 - Refer to the character list on page 9.
7. Press .
 - To program other E-mail addresses, repeat from step 4.
8. Press  (stop).

Note:

- Up to 30 addresses can be stored.



9

File formats you can receive

- JPEG
- TIFF
- BMP
- TXT
- ~. doc
- ~. xls
- ~. ppt
- ~. pdf

10

Receiving E-mail

1. Press  and then .
 - When you choose the **Receive on recording paper**, the E-mail will be print out.
 - When you choose the **Receive in memory**, E-mail receiving box will be displayed.





新規(メモ) 102件 合計08件 (11枚)			
日付	時刻	枚	相手局名
*01	3月10日 21:59	01	088765432
*02	3月10日 13:40	03	
03	3月9日 8:05	01	
04	2月25日 22:15	02	マツダ
05	1月10日 9:00	01	トヨタ

削除 印字 表示 一覧切替

2. To choose the desired E-mail to display, press  or .

新規(メモ) 102件 合計08件 (11枚)			
日付	時刻	枚	相手局名
*02	3月10日 13:40	03	
03	3月9日 8:05	01	
04	2月25日 22:15	02	マツダ
05	1月10日 9:00	01	トヨタ

削除 印字 表示 一覧切替

3. Press  to see the desired E-mail.
 - Refer to the information about display on page 12.
 - To print out the displayed page, press .
 - To see the other E-mails, press  and continue from step 2 again.
4. To go back to the stand-by mode, press .

Using Hand Scanner

Scanning a document

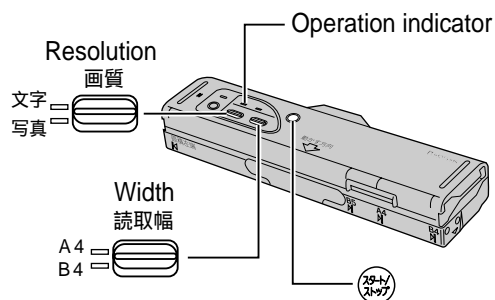

1 Pull out the Hand scanner, and then turn over it.

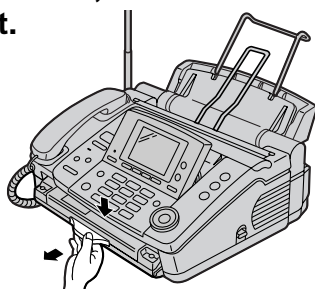

2 Choose the desired resolution by Resolution switch.

- Resolution types
 - 文字 (Letter: For documents of letters)
 - 写真 (Photo: For documents containing photographs, etc.)

3 Choose the desired Scanning width by Scanning width switch.

- Scanning width types
 - A4 (Within 208mm)
 - B4 (Within 252mm)

4 Place the scanning position and the 原稿左端 (document left side) on the document.

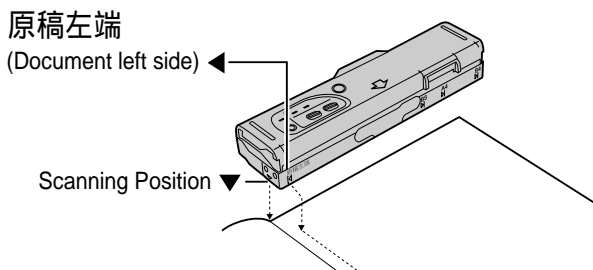

5 Press 

- You will hear a beep, and the operation indicator will light green after about 1 or 2 seconds. You can start scanning after the operation indicator lights green.

6 Press the hand scanner against the document, and move it slowly towards the direction of the arrow (↓).

- When it is scanning properly, the operation indicator will flash green.
- Scanning speed for different resolution types, see "Operation indicator and warning beep" of the next page.

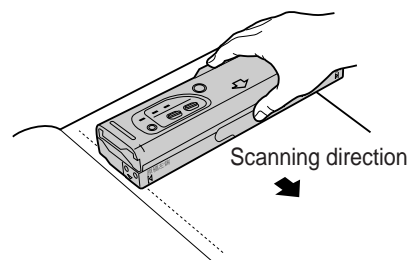

7 After scanning the document, press 

8 Insert the hand scanner in the Main unit.

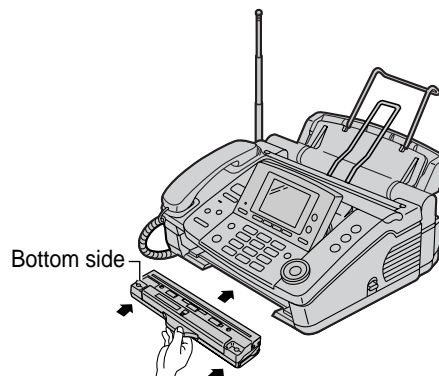

The scanned page number is displayed.

読取枚数 枚
[< >]

Scanner Memory capacity

Resolution switch	Scanning Speed	Capacity
Letter 「文字」	50mm/1 sec	Apprx. 10 pages (document paper size-A4, 700 letters)
	100mm/1 sec	Apprx. 20 pages (document paper size-A4, 700 letters)
Photo 「写真」	-	Apprx. 1 pages (document paper size-A4, photo)

Operation indicator and warning beep

When scanning documents, check the operation indicator light.

Operation Indicator	Warning Beep	Situation	Remedy
Green light Slow flash	No beep	The document is being scanned properly. (Small size letter mode)	
Green light Fast flash	No beep	The document is being scanned properly. (Normal size letter mode)	
Green light ON	No beep	The hand scanner is temporarily stopped during scanning. You did not move the hand scanner for more than 30 seconds, so it has stopped scanning automatically.	To start scanning again, press  .
Red light ON	No beep	The hand scanner is being moved quickly. (The document is being scanned.)	Move it more slowly.
Red light ON	1 beep	The hand scanner is being moved too quickly. (Some parts of the document may not be scanned, or the scanned contents may be too compressed.)	Move it more slowly.
Light OFF	3 beep	The scanner memory is full. (Memory indicator green light will flash fast.)	Delete the contents memorized in the scanner (see 24 page).
		You have scanned a document that is more than 1.5m in length as 1 page.	Scan the document as 2 pages or more.
Light OFF	No beep	The scanner is not operated.	

Memory indicator

Shows the amount of scanner memory being used.

Memory indicator (green light)	Memory used
OFF	0%
ON	~ 66%
Flash slow	~ 99%
Flash fast	100%

Using Hand Scanner

Printing all pages of memorized content

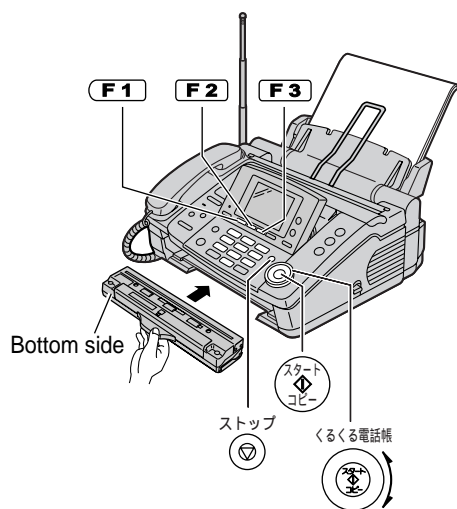

1 Insert the Hand scanner in the Main unit or press **F2** (スキャナ) .

Example: 10 pages

読取枚数	10枚
	[ぐるぐる]

The scanned page number is displayed.

2 Press **F2** (一括印字) .
Printing is started.

印字中	1枚目
-----	-----

Printing a specific page of memorized content

1 Insert the Hand scanner in the Main unit or press **F2** (スキャナ) .

Example: 10 pages

読取枚数	10枚
	[ぐるぐる]

The scanned page number is displayed.

2 Rotate **ぐるぐる電話帳** (Rotating Phone Book) until **スタート指定印字** (Start Designated Printing) [ぐるぐる, スタート] is displayed.

3 Press **スタート** (Start) (コピー) .

開始ページ	01
-------	----

4 Enter the number of the first page that you want to print using 2 digits.

Example: page 7

開始ページ	07
-------	----

When you have misentered, press **クリア** (Clear) (F1) and reenter.

5 Press **登録** (Register) (F3) .

終了ページ	07
-------	----

6 Enter the number of the last page that you want to print using 2 digits.

Example: page 10

終了ページ	10
-------	----

When you have misentered, press **クリア** (Clear) (F1) and reenter.

7 Press **登録** (Register) (F3) .

印字中	7枚目
-----	-----

(Example)

Printing will start.

Fax sending all pages of memorized content

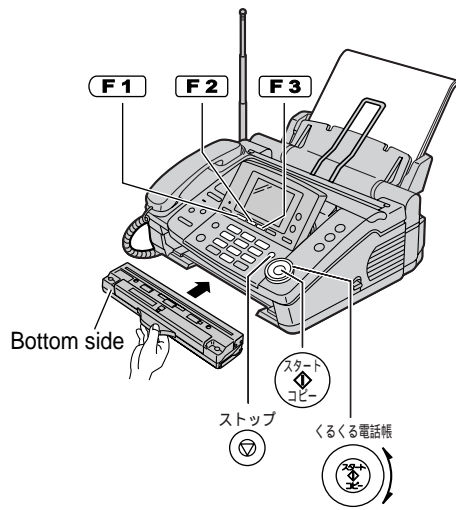

1 Insert the Hand scanner in the Main unit or press **F2**.

Example: 10 pages

読取枚数	10枚
	[くるくる]

The scanned page number is displayed.

2 Rotate  until

一括印字
[くるくる, スタート]

 is displayed.

3 Press .

電話番号?

4 Dial the fax number.

(Example: 09876543..)

電話番号?
09876543..

5 Press .

スキヤナ-送信 1枚目

The unit will start fax transmission.

Fax sending a specific page of memorized content

1 Insert the Hand scanner in the Main unit or press **F2**.

Example: 10 pages

読取枚数	10枚
	[くるくる]

The scanned page number is displayed.

2 Rotate  until

^-ジ' 指定送信
[くるくる, スタート]

 is displayed.

3 Press .

開始 ^-ジ'
01

4 Enter the number of the first page that you want to print using 2 digits.

Example: page 7

開始 ^-ジ'
07

If you make a mistake, press **F1** and reenter.

5 Press **F3**.

終了 ^-ジ'
07

6 Enter the number of the last page that you want to print using 2 digits.

Example: page 10

終了 ^-ジ'
10

7 Press **F3**.

電話番号?

8 Dial the fax number.

(Example: 09876543..)

電話番号?
09876543..

9 Press .

スキヤナ-送信 7枚目

The unit will start fax transmission.

Using Hand Scanner

Deleting all pages of memorized content

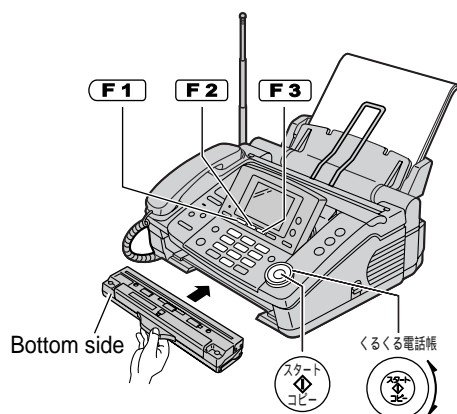

1 Insert the Hand scanner in the Main unit or press **F2**.

Example: 10 pages
読取枚数 10枚 [くるくる]
The scanned page number is displayed.

2 Rotate **くるくる電話帳** until **一括消去 [くるくる, スタート]** is displayed.

3 Press **スタート/コピー**.

4 Press **はい**.

Deleting will start.

すへて消去しますか?

消去しました

↓

読取枚数 0枚

Deleting a last page of memorized content

1 Press **消去** until beep is heard.
(Approx. 2 sec)

- The last page will be delete.

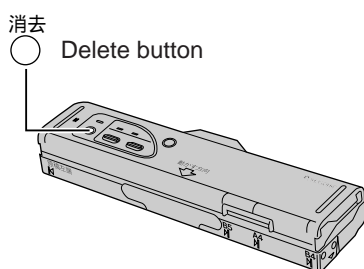

Deleting a specific page of memorized content

1 Insert the Hand scanner in the Main unit or press **F2**.

Example: 10 pages
読取枚数 10枚 [くるくる]
The scanned page number is displayed.

2 Rotate **くるくる電話帳** until **^° -ジ' 指定消去 [くるくる, スタート]** is displayed.

3 Press **スタート/コピー**.

開始 ^° -ジ' 01

4 Enter the number of the first page that you want to delete using 2 digits.

Example: page 7
開始 ^° -ジ' 07

When you have misentered, press **クリア** and reenter.

5 Press **登録**.

終了 ^° -ジ' 07

6 Enter the number of the last page that you want to delete using 2 digits.

Example: page 10
終了 ^° -ジ' 10

When you have misentered, press **クリア** and reenter.

7 Press **登録**.

消去しますか?

8 Press **はい**.

Deleting will start.

消去しました

↓

読取枚数 6枚

MEMO

MEMO

MEMO

Specifications

(KX-PW76CL)	Main unit	Portable Handset	Battery Charger	Hand scanner
Power supply	AC 100V (50Hz/60Hz)	Ni-Cd battery (Part no. KX-FAN37) DC 2.4V 600mAh	AC Adaptor (Part no. PFAP1009) AC 100V(50Hz/60Hz) Output(DC7.5V 100mA)	Ni-Cd battery (Part no. KX-FAN36) DC 4.8V 600mAh
Power Consumption	Transmission: Approx. 20W Reception: Approx. 24W Copy: Approx. 25W Stand by: Approx. 3.7W Maximum(*1): Approx. 130W		• Charging: Approx. 1.1W • Stand by: Approx. 0.4W	
Dimensions (H x W x D)	• Without projection. (Approx. 161x336x283mm) • LD display raise and without projection. (Approx. 196x336x283mm) • With recording paper sub-tray. (Approx. 233x336x378mm)	Approx. 190x47x40mm	Approx. 72x72x90mm	• Without projection. Approx. 40x275x83mm
Mass (Weight)	Approx. 4.7Kg With the ink film (20m).	Approx. 182g With the battery.	Approx. 77g	Approx. 452g With the battery.
Operating Environment 5°C – 35°C, 45% – 85%RH (Relative Humidity)				

(KX-PW76CL)	Main unit	Hand scanner
Applicable line	Telephone line (tone/pulse)	
DC Resistance	320Ω (*2)	
Compatibility	G3 compatible	
Document size	B4-A5(Max.257mm in width, Max. 800mm in length)	
Effective Scanning size	252mm (B4) 208mm (A4)	Max. 252mm (B4)
Effective Printing size	206mm (A4 Letter size thermal paper) role type 202mm (A4 Plain paper)	
Transmission time	Approx. 15s/page (Original mode) (*3)	
Modem speed	9600/7200/4800/2400bps; Automatic fallback	
Halftone Level	64-level	
Scanning Density	Horizontal: 8 pels/mm Vertical: 7.7 lines/mm – Fine. 3.85 lines/mm – Standard	Horizontal:8 pels/mm Vertical: 7.7 lines/mm
Scanner type	CCD image sensor	
Printer type	Thermal printing	
Data Compression System	Modified Huffman (MH), Original	
Recording paper Size	A4 Letter size thermal paper (Role type) 216mmx30m (Spindle diameter: approx. 13mm.) A4 Plain paper (210mmx297mm)	
Answering Device	Greeting message: Digital recording system (up to 16 sec) Pre-recording greeting message ICM Recording: Digital recording system (Approx. 18 min. in total)	
Memory Capacity	Max. Approx. 50 pages (Only receiving fax etc.) (*4) Max. Approx. 18 min. (Only Recording message)	20 pages Text (Standard) (*5) 10 pages Text (Fine) (*5) Approx. A4 1 page (Photo)

*1 When copying a 100% black document.

*2 If you can not make a voice call due to 320Ω of DC resistance, consult your dealer.

*3 The transmission speed is based on an A4-size document of 700 characters sent in standard resolution at 9600 bps.

*4 Number of page is based on an A4-size document of 700 characters received in standard resolution (8 pels/mm x 3.85 line/mm).

*5 The memory capacity is based on an A4-size document of 700 characters.