

Panasonic

Personal FAX

Model No.

KX-FT21HK

Quick Start



To get started,
please read the
Quick Start section
(p. 4-9).

Initial
Preparation

Telephone

Fax/Copy

Help

General
Information

OPERATING INSTRUCTIONS

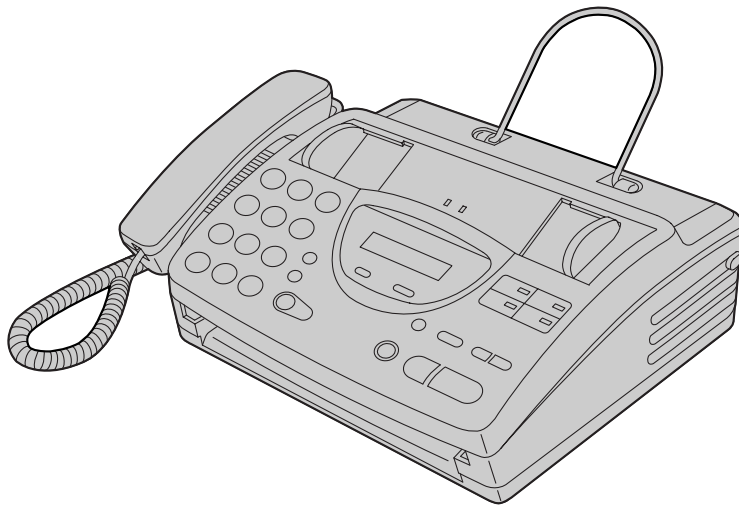

Please read these Operating Instructions before using the unit and save for future reference.

Kyushu Matsushita Electric Co., Ltd.

1-62, 4-chome, Minoshima, Hakata-ku, Fukuoka 812-8531, Japan

Printed in Hong Kong

PFQX1383ZA WH1199WN0

Thank you for purchasing a Panasonic facsimile.

Welcome to the world of Panasonic facsimiles.

This product combines the facsimile, telephone and copier features, to provide you with more efficient office or home use. By utilising these convenient features, you can maximise the effectiveness of this unit.

For your future reference

Date of purchase

Serial number

(found on the bottom of the unit)

Dealer's name and address

Dealer's telephone number

Copyright:

This manual is copyrighted by Kyushu Matsushita Electric Co., Ltd. (KME) and its licensee. Under the copyright laws, this manual may not be reproduced in any form, in whole or part, without the prior written consent of KME and its licensee.

© Kyushu Matsushita Electric Co., Ltd. 1999

Important safety instructions

When using this unit, basic safety precautions should always be followed to reduce the risk of fire, electric shock, or personal injury.

1. Read and understand all instructions.
2. Follow all warnings and instructions marked on this unit.
3. Unplug this unit from AC outlets before cleaning. Do not use liquid or aerosol cleaners. Use a damp cloth for cleaning.
4. Do not use this unit near water, for example near a bath tub, wash bowl, kitchen sink, or the like.
5. Place the unit securely on a stable surface. Serious damage and/or injury may result if the unit falls.
6. Do not cover slots and openings on the unit. They are provided for ventilation and protection against overheating. Never place the unit near radiators, or in a place where proper ventilation is not provided.
7. Use only the power source marked on the unit. If you are not sure of the type of power supplied to your home, consult your dealer or local power company.
8. For safety purposes this unit is equipped with a three prong grounded plug. If you do not have this type of outlet, please have one installed. Do not use any type of adaptor plug to defeat this safety feature.
9. Do not place objects on the power cord. Install the unit where no one can step or trip on the cord.
10. Do not overload wall outlets and extension cords. This can result in the risk of fire or electric shock.
11. Never push any objects through slots in this unit. This may result in the risk of fire or electric shock. Never spill any liquid on the unit.
12. To reduce the risk of electric shock, do not disassemble this unit. Take the unit to an authorised servicer when service is required. Opening or removing covers may expose you to dangerous voltages or other risks. Incorrect reassembly can cause electric shock when the unit is subsequently used.
13. Unplug this unit from the wall outlet and refer servicing to an authorised servicer when the following conditions occur:
 - A. When the power supply cord or plug is damaged or frayed.

- B. If liquid has been spilled into the unit.
 - C. If the unit has been exposed to rain or water.
 - D. If the unit does not work normally by following the operating instructions. Adjust only controls covered by the operating instructions. Improper adjustment may require extensive work by an authorised servicer.
 - E. If the unit has been dropped or physically damaged.
 - F. If the unit exhibits a distinct change in performance.
14. During thunderstorms, avoid using telephones except cordless types. There may be a remote risk of an electric shock from lightning.
 15. Do not use this unit to report a gas leak, when in the vicinity of the leak.

SAVE THESE INSTRUCTIONS

INSTALLATION

1. Never install telephone wiring during a lightning storm.
2. Never install telephone jacks in wet locations unless the jack is specifically designed for wet locations.
3. Never touch uninsulated telephone wires or terminals unless the telephone line has been disconnected at the network interface.
4. Use caution when installing or modifying telephone lines.

WARNING

- To prevent the risk of fire or electrical shock, do not expose this product to rain or any type of moisture.

OTHER INFORMATION

- Keep the unit away from electrical noise generating devices, such as fluorescent lamps and motors.
- The unit should be kept free from dust, high temperature and vibration.
- The unit should not be exposed to direct sunlight.
- Do not place heavy objects on top of this unit.
- Do not touch the plug with wet hands.

Installing the recording paper

- 1 Open the cover by pressing the cover open button.

- 2 Install a recording paper roll.

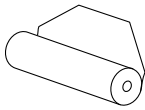

correct

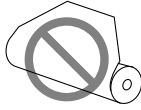

incorrect

- 3 Pull the leading edge of the paper out of the unit.

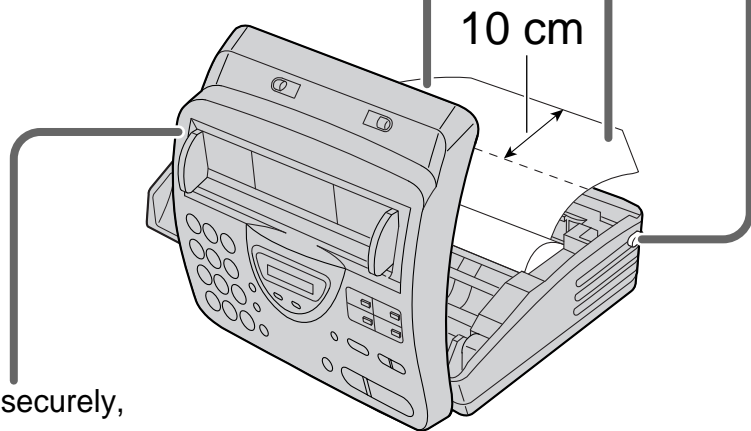

10 cm

- 4 Close the cover securely, and tear off the excess paper.

- 5 Install the document stacker.

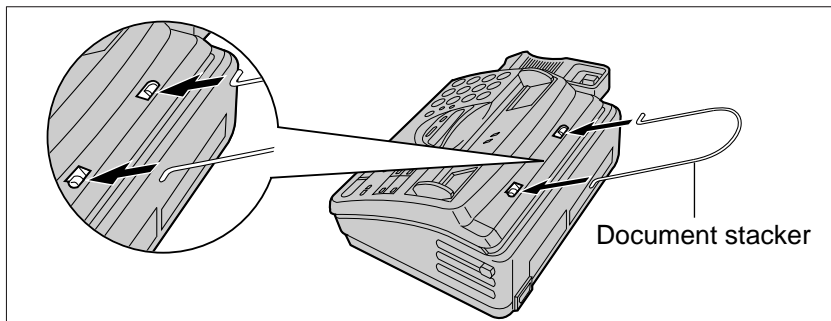

Document stacker

● For further details, see page 17.

Connections

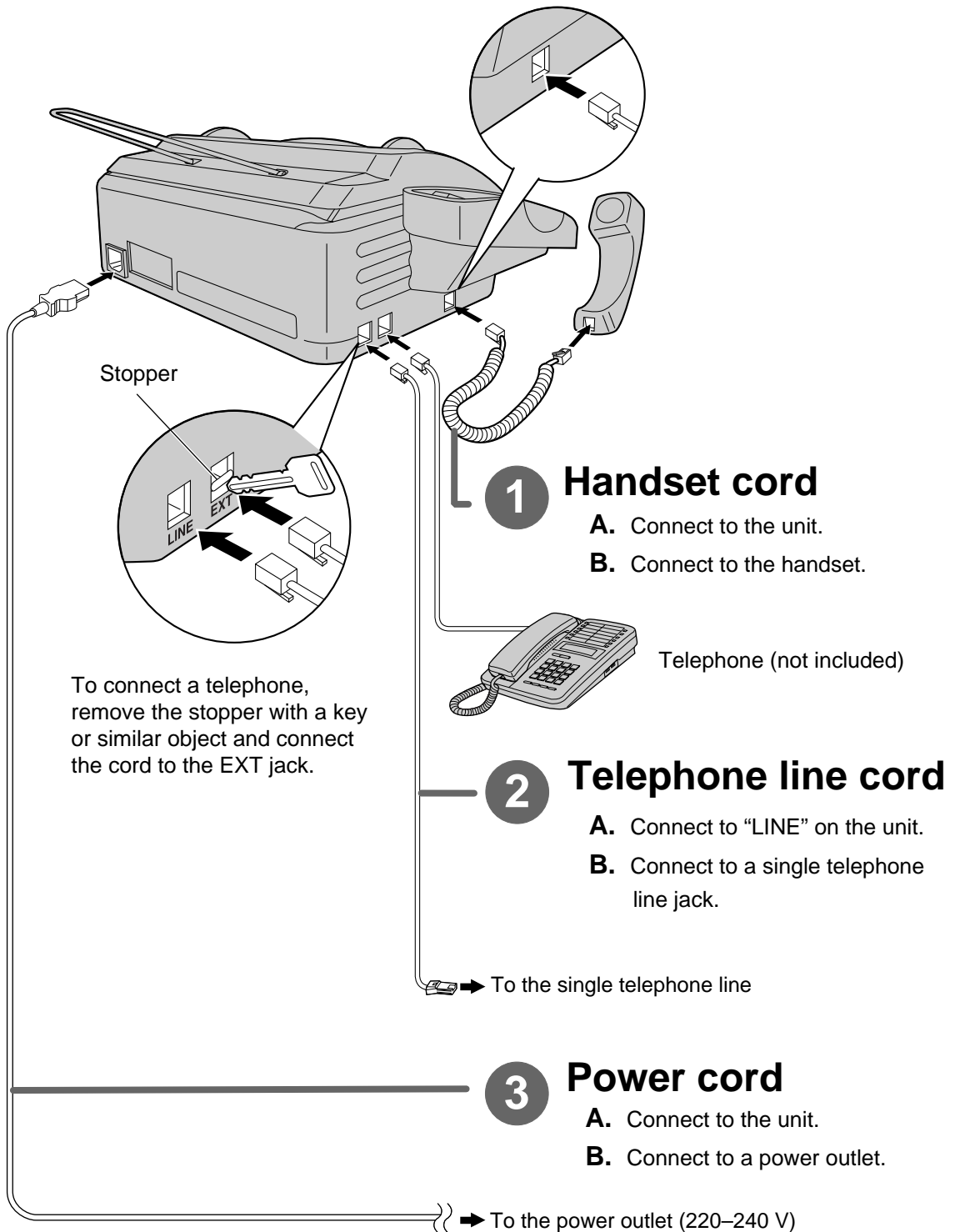

● For further details, see page 18.

Voice calls - making

1 Lift the handset.

2 Dial the number.

3 When finished talking, replace the handset.

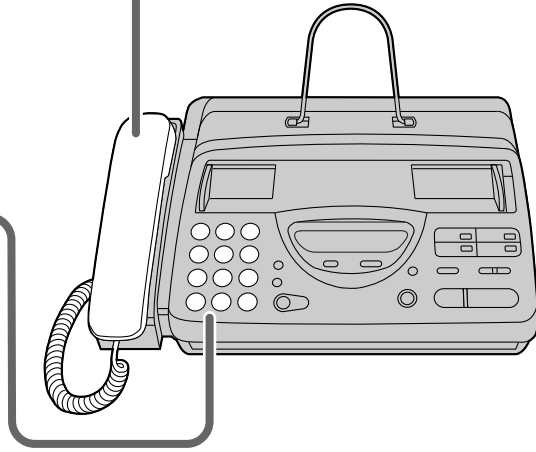

- For further details, see page 24.
- If you are having trouble, see page 58.

Voice calls - answering

1 When the unit rings, lift the handset.

2 When finished talking, replace the handset.

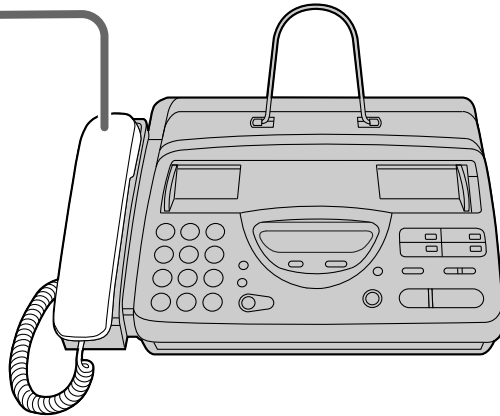

- For further details, see page 25.
- If you are having trouble, see page 58.

Fax - sending

- 1 Check that the document stacker is in the upright position.

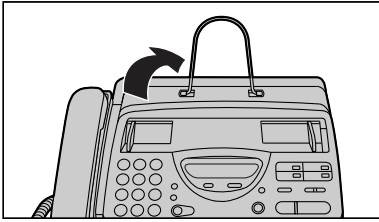

- 2 Adjust the width of the document guides to the size of the document.

- 3 Insert the document until the unit grabs the document and a single beep is heard.

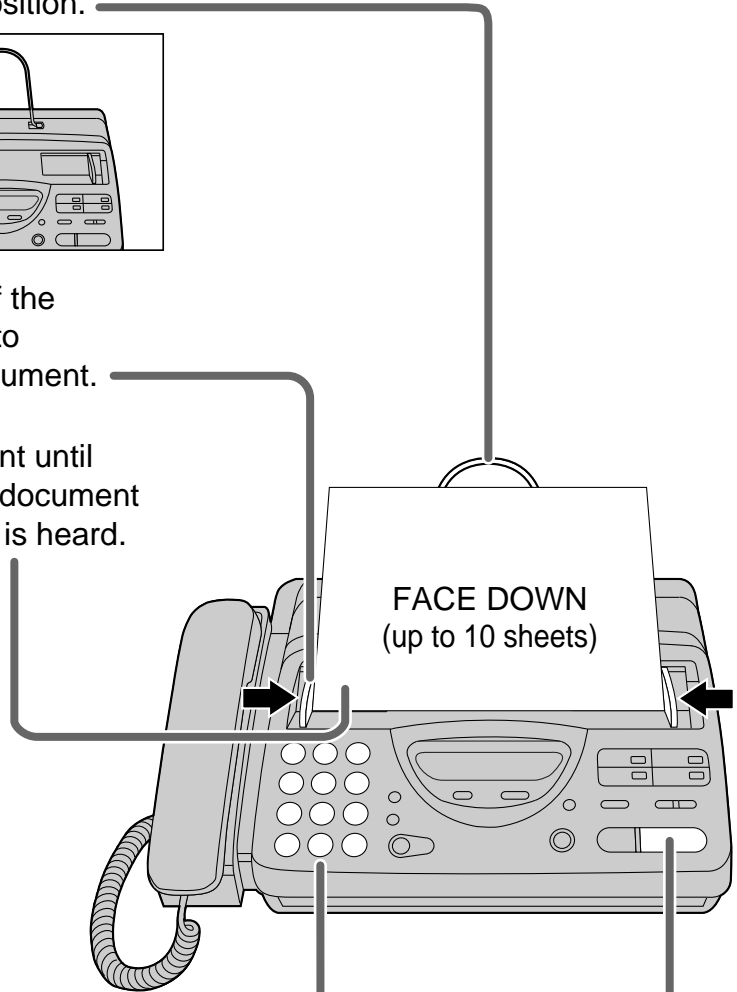

- 4 Dial the fax number.

- 5 When a fax tone is heard, press **START/COPY/SET**.

- For further details, see page 31.
- If you are having trouble, see pages 58 and 59.

Fax - receiving

1 When the unit rings, lift the handset.

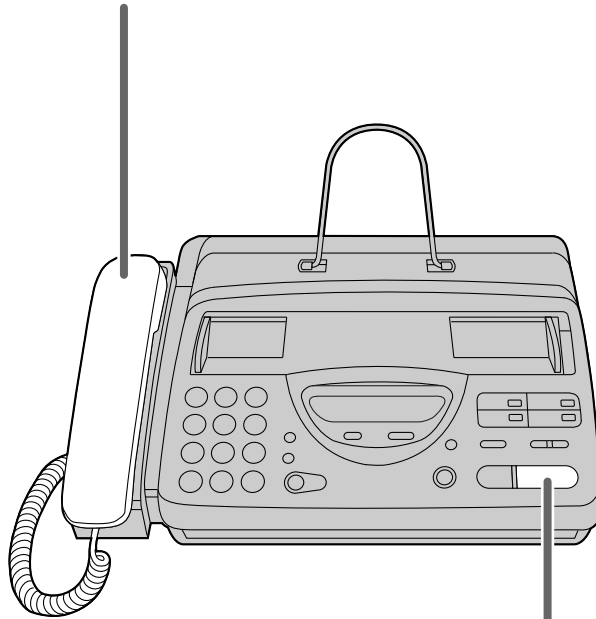

2 When:
— document reception is required,
— a fax calling tone (slow beep) is heard, or
— no sound is heard,
press **START/COPY/SET**.

3 Replace the handset.

- For further details, see page 42.
- You can select the way to receive calls according to your needs (p. 40, 41).
- If you are having trouble, see page 59.

Copying

- 1 Check that the document stacker is in the upright position.

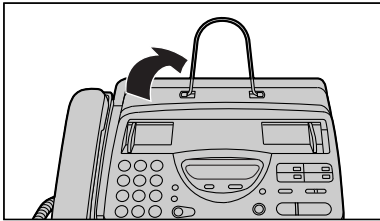

- 2 Adjust the width of the document guides to the size of the document.

- 3 Insert the document until the unit grabs the document and a single beep is heard.

- Make sure the handset is on the cradle.

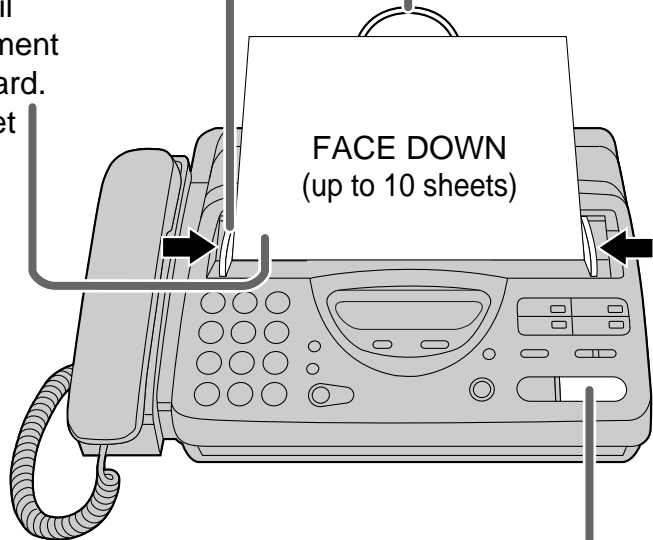

- 4 Press **START/COPY/SET**.

- For further details, see page 55.
- If you are having trouble, see page 60.

Table of Contents

Initial Preparation

Accessories	Included accessories	12
	Accessory order information.	12
Help Button	Help function	13
Finding the Controls	Location	14
	Overview	16
Setup	Recording paper	17
	Document stacker	17
	Connections	18
	Dialling mode (touch tone or pulse)	18
	Date and time, your logo and facsimile telephone number	19
Volumes	Adjusting volumes	23

Telephone

Making and Answering Calls	Voice calls - making	24
	Voice calls - answering	25
	TONE, FLASH and PAUSE buttons.	26
Automatic Dialling	Storing names and telephone numbers for automatic dialling	27
	Making a voice call using automatic dialling	28
	Telephone Directory with Alpha-Search (selecting a station name in the directory)	29
Voice Contact	Talking to the caller after fax transmission or reception	30

Fax/Copy

Sending Faxes	Sending a fax manually.	31
	Sending a fax using automatic dialling.	32
	Documents you can send	33
	Sending report for confirmation	34
	Automatic journal report	35
	Delayed transmission (sending a fax at a specified time).	36
	Transmit polling (letting another machine retrieve a fax on your unit)	37
	Overseas mode	38
	Connecting tone	39
Receiving Faxes	Setting the unit to receive calls	40
	TEL mode (answering all calls manually).	42

(continued)

Fax/Copy

Receiving Faxes	FAX ONLY mode (all calls are received as faxes)	43
(continued)	Extension telephone	45
	Fax activation code	45
	Receiving with a duplex ring service	46
	TEL/FAX mode (receiving voice calls with rings and fax calls without rings when you are near the unit)	48
	Receiving polling (receiving a fax placed on another party's machine) .	52
	Friendly reception	52
	Auto disconnection	53
	Pager call - when your unit receives a fax	54
Copying	Making a copy	55

Help





Error Messages	Reports	56
	LCD display	57
Operations	When a function does not work, check here before requesting help.	58
	If a power failure occurs	60
Jams	Recording paper jam	61
	Document jam	62
	Sending document does not feed, or multi-feeds	62
Cleaning	Document feeder	63
	Thermal head	63

General Information

Print Reports	Printing the feature settings, telephone numbers, journal	64
Original Mode	Setting the original mode	65
Reset	Resetting the advanced features	65
Specifications	Technical data about this product	66
Index	Index	67
Features Summary	Summary of user programmable features	69

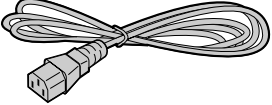
Accessories

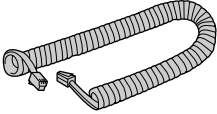
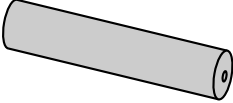
Included accessories

Power cord1pc. 	Telephone line cord1pc. 	Handset1pc. 
Handset cord1pc. 	Recording paper1pc. 	Document stacker.....1pc. 

- If any items are missing or damaged, check with the place of purchase.
- Save the original carton and packing materials for future shipping and transportation of the unit.

Accessory order information

Use the following types of paper for replacement.

Model No.	Description	Specifications
KX-A106	Standard thermal recording paper	216 mm x 30 m (8½" x 98') roll, with 25 mm (1") core

Help function

You can print a quick reference for assistance as follows.

1 Select which operation you want to print by pressing **HELP** repeatedly.

- Pressing **HELP** **one time:**

How to use your unit

HOW TO USE

two times:

How to program names and telephone numbers

PHONE NUMBER

three times:

How to program your unit

HOW TO SET UP

2 Press **START/COPY/SET**.

PRINTING



Finding the Controls

Location

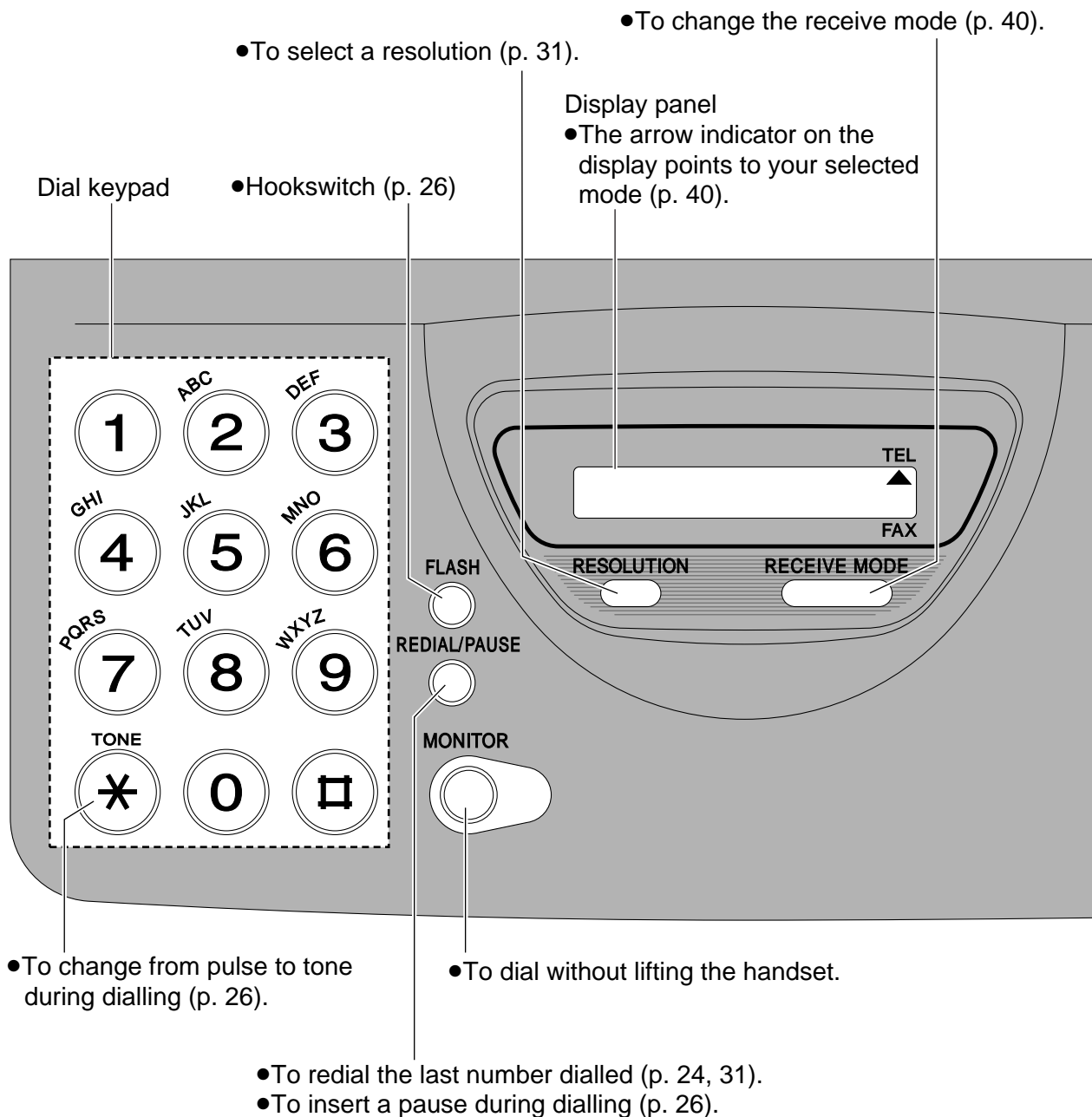

- To print a quick reference (p. 13).

- For the Speed Dial (p. 28, 32).
- For the Telephone Directory with Alpha-Search (p. 29).

- For the One-Touch Dial (p. 27, 28, 32).
- Command keys (p. 21).

- To insert a hyphen (p. 21, 27).

- To keep the telephone number secret (p. 27).

- To insert one character or one space (p. 20, 21).

- To select stations 4–6 for the One-Touch Dial (p. 27, 28, 32).

- To adjust volumes (p. 23).

- To select feature settings during programming.

- To search for a stored name (p. 29).

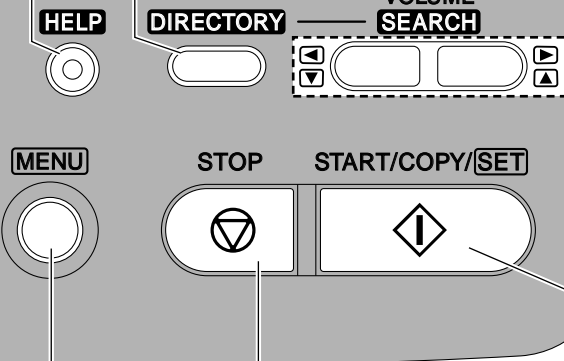

- To initiate or exit programming.
- To stop an operation or cancel programming.

- To initiate fax transmission, reception or copying.
- To store a setting during programming.

Finding the Controls

Overview

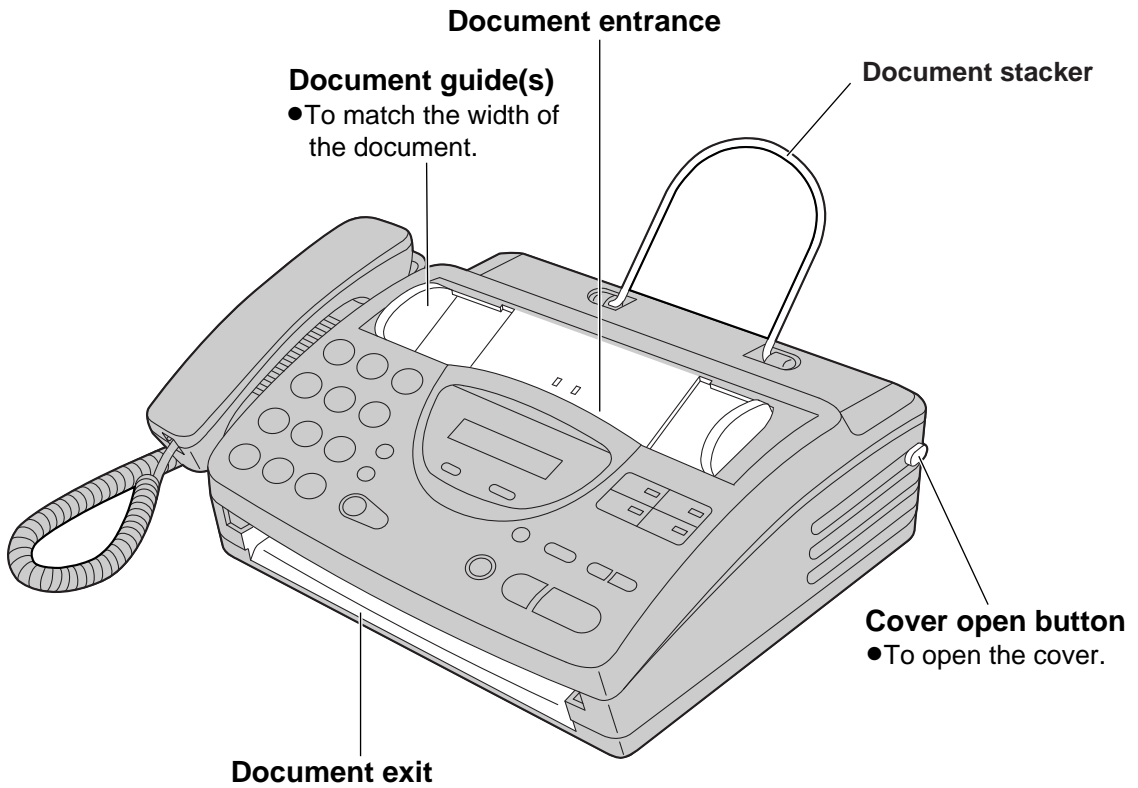

Recording paper

- 1** Open the cover by pressing the cover open button and install the recording paper roll.

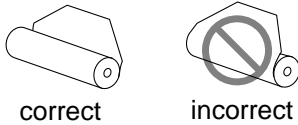

correct

incorrect

- If the paper is secured with glue or tape, cut approximately 15 cm (6 inches) from the beginning.

- 2** Pull the leading edge of the paper approximately 10 cm (4 inches) out of the unit.

- Make sure that there is no slack in the paper roll.

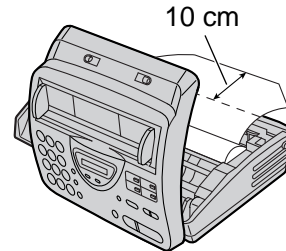
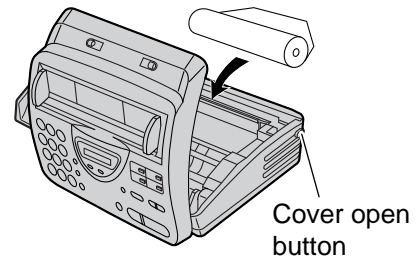

- 3** Close the cover securely by pushing down on both ends.

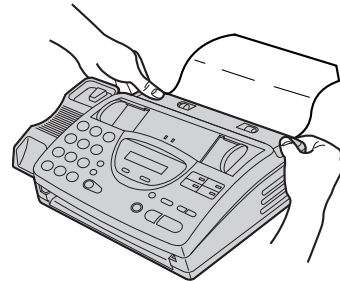

- 4** Tear off the excess paper by pulling it towards you.



Note:

- Only use the included roll of paper or specified recording paper, or else the print quality may be affected and/or excessive thermal head wear may occur.
- For accessory order information, see page 12.
- When the power cord is connected, everytime you close the cover a message will be printed. If the recording paper is set to the wrong side, the message will not be printed. Install the paper correctly.

Document stacker

Install the document stacker.

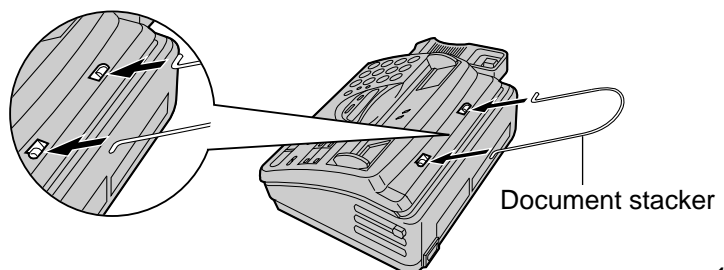

Setup

Connections

- 1 Connect the handset cord.
- 2 Connect the telephone line cord.
- 3 Connect the power cord.

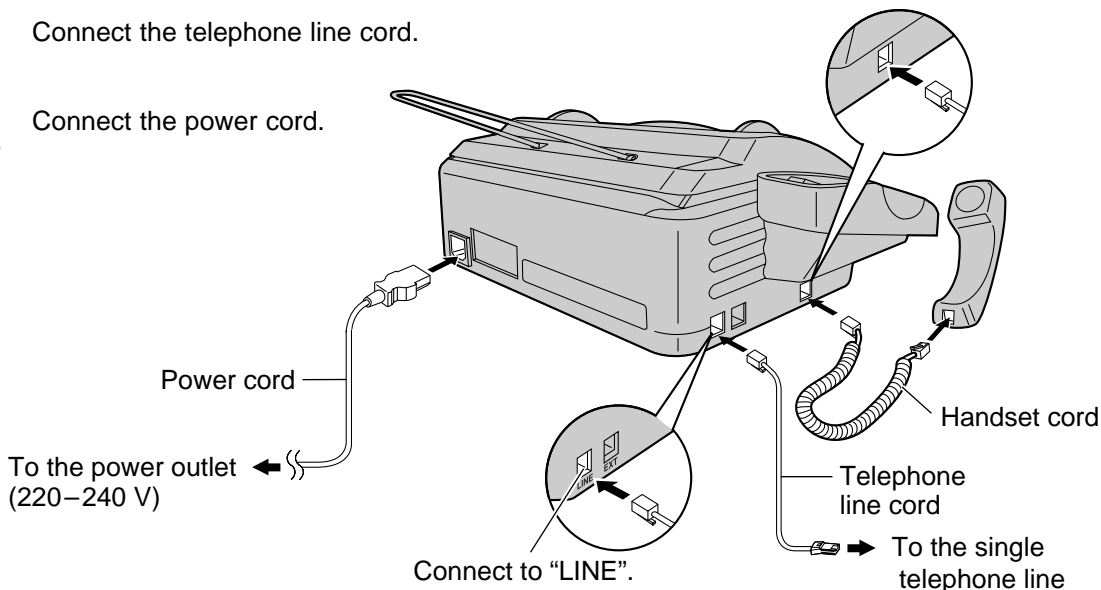

Note:

- When you operate this product, the power outlet should be near the product and easily accessible.

Dialling mode (touch tone or pulse)

This feature is set to "TONE" as a pre-selected setting. If you cannot dial, change the dialling mode setting to "PULSE" by following the instructions below.

- 1 Press **MENU**.
Display: SYSTEM SET UP
- 2 Press **Ⓜ**, then **1** **3**.
DIALING MODE
- 3 Press **START/COPY/SET**.
MODE=TONE ▼▲
- 4 Press ▼ or ▲ to select "PULSE".
- 5 Press **START/COPY/SET**.
SETUP ITEM []
- 6 Press **MENU**.

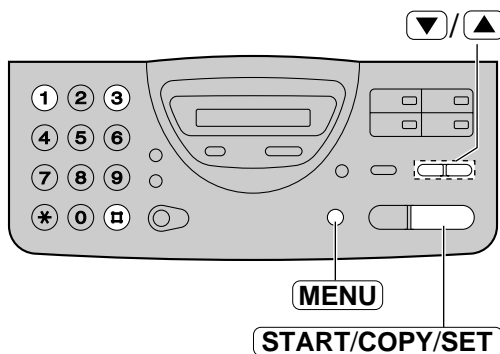

Note:

- To return to TONE, select "TONE" in step 4.

Date and time, your logo and facsimile telephone number

You should program the date and time, your logo and facsimile telephone number. This information will be printed on each page transmitted from your unit.

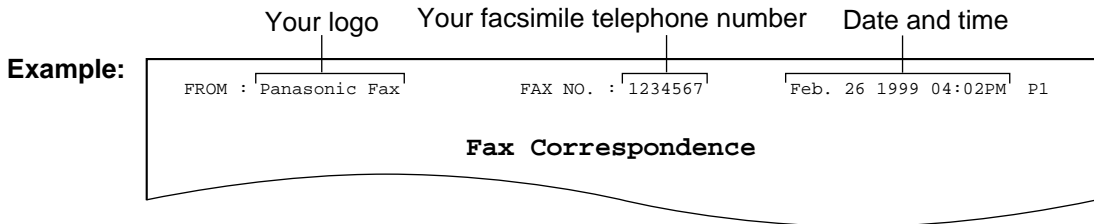

Setting the date and time

1 Press **MENU**.
Display: SYSTEM SET UP

2 Press **□**, then **0 1**.
SET DATE & TIME

3 Press **START/COPY/SET**.
M:01/D:01/Y:99
Cursor

4 Enter the correct month/day/year by selecting 2 digits for each, using the dial keypad.
Example: Aug. 10, 1999
Press **0 8 1 0 9 9**.
M:08/D:10/Y:99

5 Press **START/COPY/SET**.
TIME: 12:00AM

6 Enter the correct hour/minute by selecting 2 digits for each, using the dial keypad.
Press ***** to select "AM" or "PM".
Example: 3:15PM
1. Press **0 3 1 5**.
TIME: 03:15AM

2. Press ***** until "PM" is displayed.
TIME: 03:15PM

7 Press **START/COPY/SET**.
SETUP ITEM []

8 Press **MENU**.

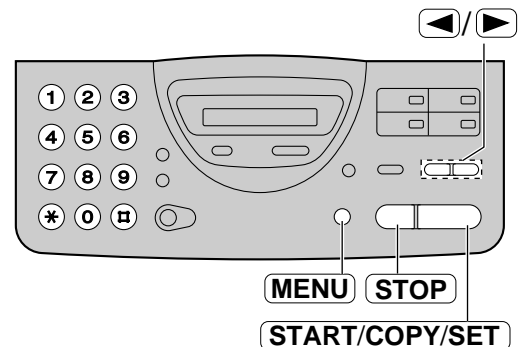

Note:

- The accuracy of the clock is approximately ± 60 seconds a month.

■ To correct a mistake

- Press **◀** or **▶** to move the cursor to the incorrect number, then make the correction.
- If you press **STOP** while programming, the display will return to the previous one.

Setup

Setting your logo

The logo can be your company, division or name.

1 Press **MENU**.
Display: SYSTEM SET UP

2 Press **□**, then **0 2**.
YOUR LOGO

3 Press **START/COPY/SET**.
LOGO=

4 Enter your logo, up to 30 characters, using the dial keypad. See next page for details.

Example: Bill

1. Press **2** twice.

LOGO=B
Cursor

2. Press **4** six times.

LOGO=Bi

3. Press **5** six times.

LOGO=Bi

4. Press **▶** to move the cursor to the next space and press **5** six times.

LOGO=Bill

5 Press **START/COPY/SET**.
SETUP ITEM []

6 Press **MENU**.

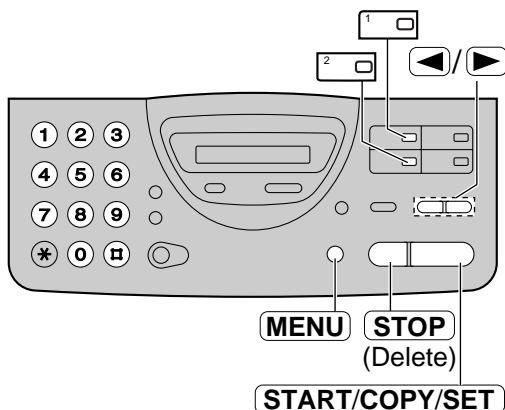

■ To correct a mistake

- Press **◀** or **▶** to move the cursor to the incorrect character, then make the correction.

■ To delete a character





- Move the cursor to the character you want to delete and press **STOP**.

■ To insert a character

1. Press **◀** or **▶** to move the cursor to the position to the right of where you want to insert the character.
2. Press **□** (One-Touch Dial key 2) to insert a space and enter the character.

■ To select characters with the dial keypad

Pressing the dial keys will select a character as shown below.

Keys	Characters
①	1 [] { } + - / = , . _ ` : ; ?
②	A B C a b c 2
③	D E F d e f 3
④	G H I g h i 4
⑤	J K L j k l 5
⑥	M N O m n o 6
⑦	P Q R S p q r s 7
⑧	T U V t u v 8
⑨	W X Y Z w x y z 9
⑩	0 () < > ! " # \$ % & ¥ * @ ^ ' →
	HYPHEN key (To insert a hyphen.)
	INSERT key (To insert one character or one space.)
STOP	Delete key (To delete a character.)
	◀ key (To move the cursor to the left.)
	▶ key (To move the cursor to the right.) To enter another character using the same number key, move the cursor to the next space.

Setup

Setting your facsimile telephone number

1 Press **MENU**.
Display: SYSTEM SET UP

2 Press **[]**, then **0 3**.
YOUR FAX NO.

3 Press **START/COPY/SET**.
NO. =

4 Enter your facsimile telephone number up to 20 digits using the dial keypad.
Example: NO. =1234567

5 Press **START/COPY/SET**.
SETUP ITEM []

6 Press **MENU**.

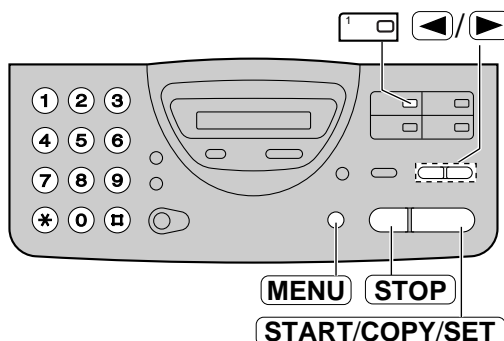

Note:

- The **[*]** button replaces the digit with a “+” and the **[#]** button replaces it with a space.
Example (using the dial keypad): +234 5678
Press **[*][2][3][4][#][5][6][7][8]**.
- To enter a hyphen in a telephone number, press **[One-Touch Dial key 1]**.

■ To correct a mistake

- Press **[Left Arrow]** or **[Right Arrow]** to move the cursor to the incorrect number, then make the correction.

■ To delete a number

- Move the cursor to the number you want to delete and press **STOP**.

Adjusting volumes

Ringer volume

4 levels (high/middle/low/off) are available.

While the unit is idle, press ▼ or ▲.

■ To turn the ringer off:

1. Press ▼ repeatedly until the following message is displayed.

Display: RINGER OFF=OK?
 ↓
YES: PRESS SET

2. Press **START/COPY/SET**.

- To turn the ringer back on, press ▲.

■ While the ringer volume is set to off:

The display will show the following message.

RINGER OFF

When a call is received, the unit will not ring and will display the following.

INCOMING CALL

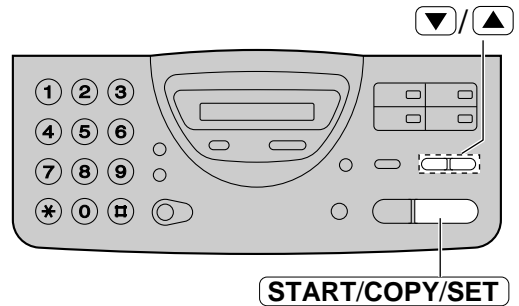

Handset receiver volume

5 levels (high to low) are available.

While using the handset, press ▼ or ▲.

Monitor volume

8 levels (high to low) are available.

While using the monitor, press ▼ or ▲.

Making and Answering Calls

Voice calls - making

1 Press **MONITOR** or lift the handset.

Display:

2 Dial the telephone number.

Example:

- If you misdial, hang up and dial again.

3 When the other party answers, speak with the handset.

4 When finished talking, replace the handset.

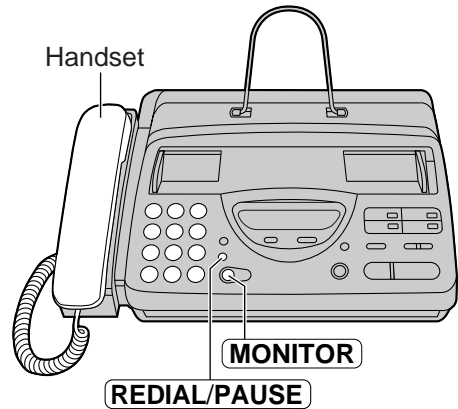

Note:

- To mute your voice to the other party, press **MONITOR** during a telephone conversation. To resume the conversation, press **MONITOR**.

■ To redial the last number

1. Press **MONITOR** or lift the handset.

2. Press **REDIAL/PAUSE**.

3. When the other party answers, speak with the handset.

- If the line is busy when using the **MONITOR** button, the unit will automatically redial the number up to 14 times.
- During redial, the following will be displayed.

Display:

Making and Answering Calls

Voice calls - answering

- 1 When the unit rings, lift the handset.
- 2 When finished talking, replace the handset.

Note:

- To mute your voice to the other party, press **MONITOR** during a telephone conversation. To resume the conversation, press **MONITOR**.

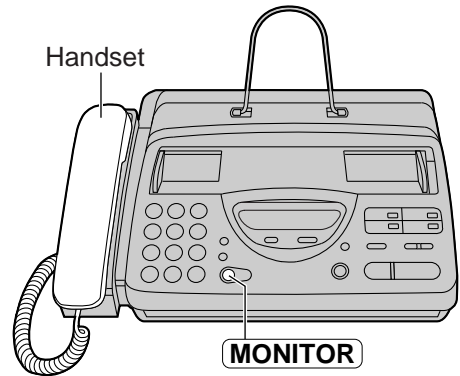

Making and Answering Calls

TONE, FLASH and PAUSE buttons

TONE button

The **TONE** (*) button is used for rotary pulse dial services and allows you to temporarily change from the pulse to tone mode during a dialling operation.

When you hang up, the unit will automatically return to the pulse mode.

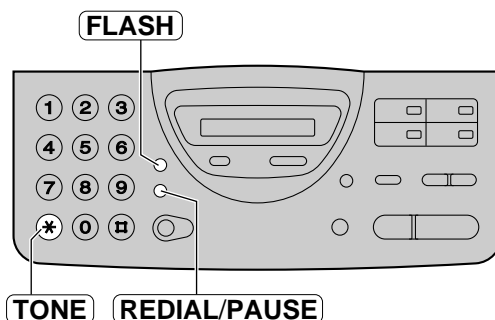

FLASH button

The **FLASH** button functions as the hookswitch on a regular telephone. If you misdial a telephone number, press the **FLASH** button firmly.

The **FLASH** button also allows you to use special features of a host exchange (if connected) or local telephone company services such as call waiting.

For further details, contact your host exchange supplier or local telephone company.

Note:

- TONE, FLASH and PAUSE can be stored into a telephone number for automatic dialling.

Entering pauses

When the **REDIAL/PAUSE** button is pressed during dialling, a pause will be inserted. Pressing **REDIAL/PAUSE** once creates a 5 second pause.

Example 1:

If your unit is connected to a host exchange, insert a pause to get an outside line.

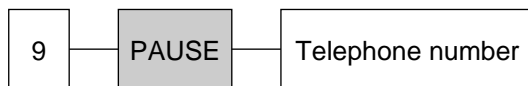

Line access code

Example 2:

If a transmission error occurs during an overseas transmission, add two pauses at the end of the telephone number.

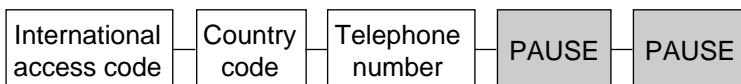

Storing names and telephone numbers for automatic dialling

The unit's memory allows you to use both the One-Touch Dial and the Speed Dial for rapid access to your most frequently dialled numbers.

One-Touch Dial: The unit is equipped with 3 One-Touch Dial keys, each of which is divided into an upper station and a lower station.

Speed Dial: The unit is equipped with 50 additional dialling stations. These stations are assigned to 2-digit numbers (00–49).

1 Press **MENU** two times.

Display:

2a **Programming for One-Touch Dial:**
For upper stations (1–3)

Press one of the One-Touch Dial keys.

For lower stations (4–6)

Press **LOWER**, then press one of the One-Touch Dial keys.

2b **Programming for Speed Dial:**

Press **START/COPY/SET**, then press the desired 2-digit number (00–49).

3 Enter the station name, up to 10 characters, by following the instructions on page 21.

Example:

4 Press **START/COPY/SET**.

Example:

5 Enter the telephone number up to 30 digits in length.

- To enter a hyphen in a phone number, press **1** (One-Touch Dial key 1).

Example:

6 Press **START/COPY/SET**.

REGISTERED



STORE TEL NO.

- To program other stations, repeat steps 2 to 6.

7 Press **STOP**.

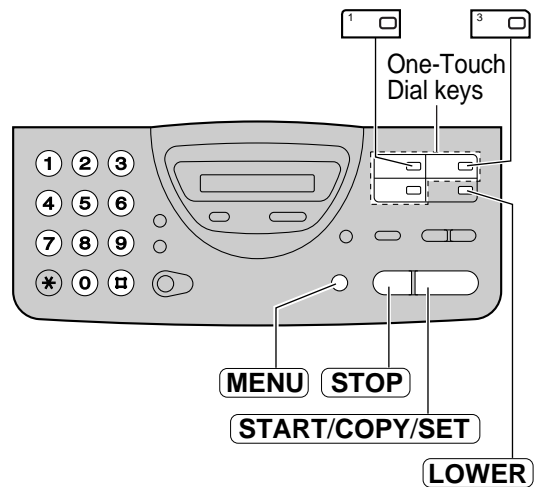

Helpful hint:

- You can confirm the stored items on the telephone number list (p. 64).

Note:

- A hyphen entered in a telephone number is counted as two digits.

■ To keep the telephone number secret

Press **3** (One-Touch Dial key 3) after entering the telephone number in step 5.

- A secret number cannot be viewed after this is set.
- The telephone number will not appear on the telephone number list.
- Pressing **3** does not count as a digit.

■ To edit a stored station name and number

Enter the desired name in step 3.

Enter the desired number in step 5.

Automatic Dialling

Making a voice call using automatic dialling =====

Before using this feature, program the desired names and telephone numbers into the One-Touch Dial or the Speed Dial (p. 27).

1 Press **MONITOR** or lift the handset.

Display:

2a **Using the One-Touch Dial:**
For stations 1–3

Press the desired One-Touch Dial key.

For stations 4–6

Press **LOWER**, then press the desired One-Touch Dial key.

Example:

2b **Using the Speed Dial:**

Press **DIRECTORY**, then press **☒** and the desired 2-digit number (00–49).

3 When the other party answers, speak with the handset.

4 When finished talking, replace the handset.

Helpful hint:

- You can confirm the stored items on the telephone number list (p. 64).

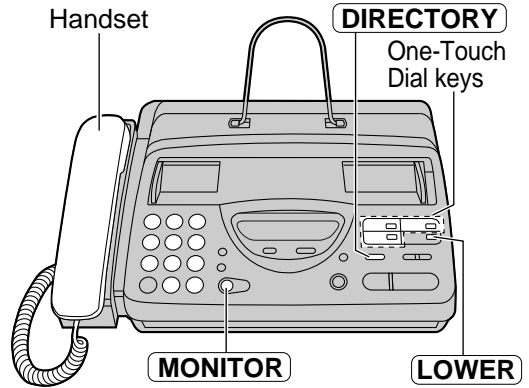

Telephone Directory with Alpha-Search ===== (selecting a station name in the directory)

The station names stored in memory are automatically registered in the electronic telephone directory in alphabetical order. You can make a fax or voice call by selecting the desired station name on the display.

If you wish to send a fax, insert the documents first.

1 Press **DIRECTORY**.

Display: SELECT INDEX

2 Press the dial key to which the first letter of the station name is assigned (see the index table below).

Example: To search for a name starting with "N":

Press **6** until the first station name starting with "N" is displayed. Press **▼** until the desired name is displayed.

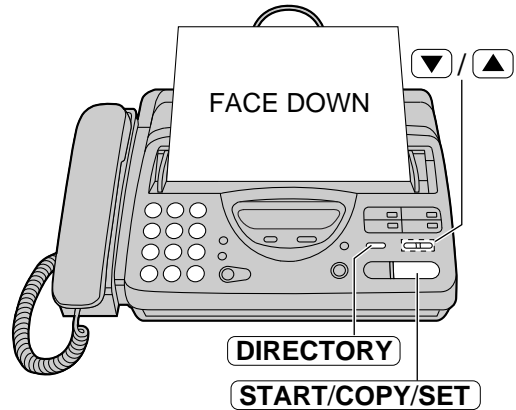

OR

Press **▼** or **▲** repeatedly until the desired name is displayed.

3 Press **START/COPY/SET**.

- The unit will start dialling.
- If a document is fed into the unit, the unit will start transmission.

Dial key	Index	Dial key	Index
1	1	7	P, Q, R, S, 7
2	A, B, C, 2	8	T, U, V, 8
3	D, E, F, 3	9	W, X, Y, Z, 9
4	G, H, I, 4	0	0
5	J, K, L, 5	*	Other symbols
6	M, N, O, 6	#	(Used for the Speed Dial)

Voice Contact

Talking to the caller after fax transmission or reception

You can talk to the other party after a fax message is completed. This will save the added expense and time of making another call.

This feature only works when the other party's fax machine is equipped with a voice contact feature.

Initiating voice contact

- 1 Press **MONITOR** while transmitting or receiving documents.

Display: VOICE STANDBY

- Your unit will call the other party with a distinctive ring.
- When the other party answers, your unit will emit a distinctive ring.

- 2 Lift the handset to start talking.

Note:

- If you initiate voice contact during transmission, the unit will call you with a distinctive ring after all of the documents have been transmitted.
- If you initiate voice contact during reception, the unit will call you with a distinctive ring after the current page of the document is received.

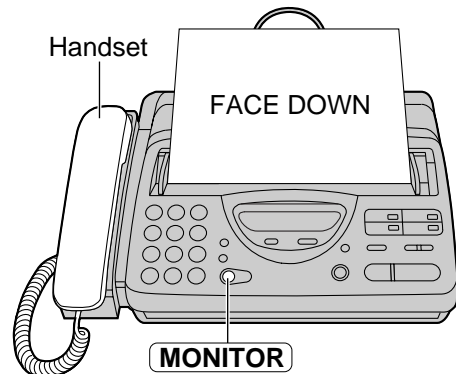

Receiving a request for voice contact

- 1 If the other party initiates voice contact, your unit will sound a distinctive ring and the following will be displayed.

Display: PLEASE PICK UP

- 2 Lift the handset within 10 seconds of the distinctive ring to start talking.

Note:

- If you do not answer within 10 seconds of the distinctive ring, the line will be disconnected.

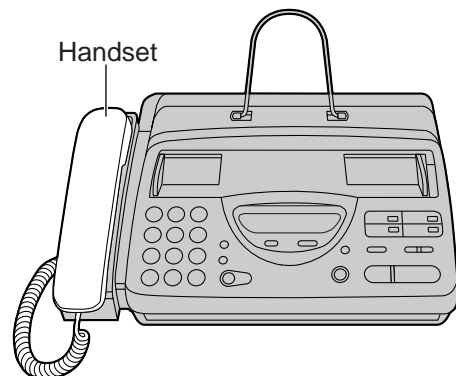

Sending a fax manually

- 1** Check that the document stacker is in the upright position.
- 2** Adjust the width of the document guides to the size of the document.
- 3** Insert the document (up to 10 pages) **FACE DOWN** until the unit grabs the document and a single beep is heard.

Display: STANDARD

- 4** If necessary, press **RESOLUTION** repeatedly to select the desired setting (see below).
- 5** Press **MONITOR** or lift the handset. (This step is optional. See note.)

TEL=

- 6** Dial the fax number.

Example: TEL=5678901

- 7** **When a fax tone is heard:**
Press **START/COPY/SET**, and replace the handset if using it.
OR

When the other party answers your call:

Lift the handset if using the monitor and ask them to press their start button. When a fax tone is heard, press your **START/COPY/SET** and replace the handset.

CONNECTING.....



Fax/Copy

Note:

- **If you cannot send a fax**, confirm the problem by printing a journal report (p. 64) and see page 56 to solve the problem.
- Performing step 5 allows you to identify any possible problems in sending a fax. For the parties with whom you have experienced no problems, you can skip step 5. Dial the fax number and press **START/COPY/SET**.

■ **To feed more than 10 pages at a time**

Insert the first 10 pages of the document. Add the extra pages (up to 10) before the last page is fed into the unit.

■ **To redial the last number**

Press **REDIAL/PAUSE**.

- If the line is busy, the unit will automatically redial the number up to 5 times.
- During redial, the following will be displayed.

Display: WAITING REDIAL

- To cancel redialing, press **STOP** again.

■ **To stop transmission**

Press **STOP**.

To eject the document, press **STOP** again.

■ **To select the resolution**

Select the desired resolution according to the type of document.

STANDARD: For printed or typewritten originals with normal-sized characters.

FINE: For originals with small printing.

SUPER FINE: For originals with minute printing.

HALF TONE: For originals containing photographs, shaded drawings, etc.

- Using the fine, super fine or half tone setting will increase the transmission time.
- If the resolution setting is changed during feeding, it will be effective from the next sheet.
- The super fine resolution only works with other compatible fax machines.

Sending Faxes

Sending a fax using automatic dialling

Before using this feature, program the desired names and telephone numbers into the One-Touch Dial or the Speed Dial (p. 27).

- 1 Check that the document stacker is in the upright position.
- 2 Adjust the width of the document guides to the size of the document.
- 3 Insert the document (up to 10 pages) **FACE DOWN** until the unit grabs the document and a single beep is heard.

Display:

- 4 If necessary, press **RESOLUTION** repeatedly to select the desired setting (p. 31).

5a Using the One-Touch Dial: For stations 1–3

Press the desired One-Touch Dial key.

For stations 4–6

Press **LOWER**, then press the desired One-Touch Dial key.

Example:



5b Using the Speed Dial:

Press **DIRECTORY**, then press and the desired 2-digit number (00–49).

- The unit will start transmission.

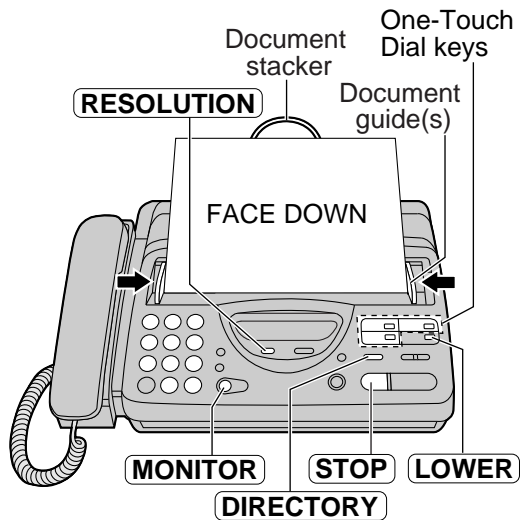

Helpful hints:

- You can confirm the stored items on the telephone number list (p. 64).
- The connecting tone will be heard during dialling to tell you the status of the other party's machine (p. 39).

■ If your unit does not send a fax

Verify that the number dialled is answered by the other party's machine.

1. Press **MONITOR**.

2a. Using the One-Touch Dial:

For stations 1–3

Press the desired One-Touch Dial key.

For stations 4–6

Press **LOWER**, then press the desired One-Touch Dial key.

2b. Using the Speed Dial:

Press **DIRECTORY**, then press and the desired 2-digit number.

■ Fax auto redial

If the line is busy or there is no answer, the unit will automatically redial the number up to 5 times.

- This feature is also available for:
 - receiving polling (p. 52), and
 - delayed transmission (p. 36).
- During redial, the following will be displayed.

Display:

- To cancel redialling, press **STOP**.

Documents you can send

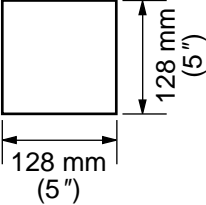
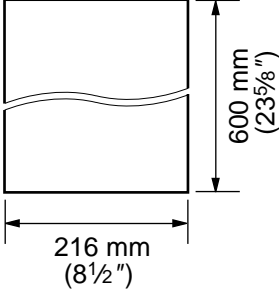
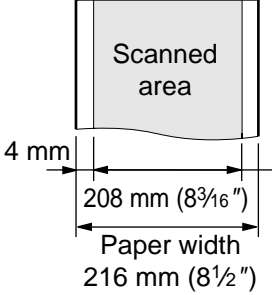
Minimum size	Maximum size	Effective scanning area	Document weight
 <p>128 mm (5")</p> <p>128 mm (5")</p>	 <p>600 mm (23 5/8")</p> <p>216 mm (8 1/2")</p>	 <p>4 mm</p> <p>208 mm (8 3/16")</p> <p>Paper width 216 mm (8 1/2")</p>	<p>Single sheet: 45 g/m² to 90 g/m² (12 lb. to 24 lb.)</p> <p>Multiple sheets: 60 g/m² to 75 g/m² (16 lb. to 20 lb.)</p>

Note:

- Remove clips, staples or other similar fastening objects.
- Check that ink, paste or correction fluid has dried.
- Do not send the following types of documents. Use copies for fax transmission.
 - Chemically treated paper such as carbon or carbonless duplicating paper
 - Electrostatically charged paper
 - Heavily curled, creased or torn paper
 - Paper with a coated surface
 - Paper with a faint image
 - Paper with printing on the opposite side that can be seen through the front (e.g. newspaper)

Sending Faxes

Sending report for confirmation

The sending report will provide you with a printed record of the fax transmission result. One of the following choices is available.

ERROR: The sending report will print out only when fax transmission fails (pre-selected setting).

ON: The sending report will always print out, indicating whether fax transmission is successful or not.

OFF: The sending report will not print.

1 Press **MENU**.
Display: SYSTEM SET UP

2 Press **0 4**.
SENDING REPORT

3 Press **START/COPY/SET**.
MODE=ERROR ▼▲

4 Press ▼ or ▲ to select the desired setting.

5 Press **START/COPY/SET**.
SETUP ITEM []

6 Press **MENU**.

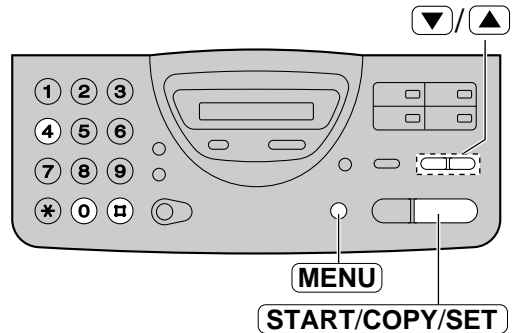

Sample of a sending report

[SENDING REPORT]		Jan. 20 1999 01:19PM						
NO.	OTHER FACSIMILE	START TIME	USAGE TIME	MODE	PAGES	RESULT	*CODE	
01	2345678	Jan. 20 01:18PM	00'51	SND	00	COMMUNICATION ERROR	(43)	

Communication message (p. 56)

Error code (for service personnel use only)

Automatic journal report

This feature prints a journal report automatically after every 35 new fax communications. After printing, only the oldest communication result will be erased when a new communication occurs. When this feature is deactivated, the unit will store the records of the fax communications, but will not print the journal report automatically.

- 1 Press **MENU**.
 Display: SYSTEM SET UP
- 2 Press **[]**, then **2 2**.
AUTO JOURNAL
- 3 Press **START/COPY/SET**.
MODE=ON ▼▲
- 4 Press **▼** or **▲** to select the desired setting.
 • If this feature is not required, select "OFF".
- 5 Press **START/COPY/SET**.
SETUP ITEM []
- 6 Press **MENU**.

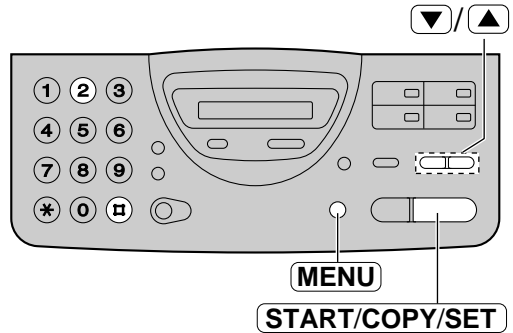

Fax/Copy

Sample of a journal report

[JOURNAL]							
Jan. 25 1999 05:22PM							
NO.	OTHER FACSIMILE	START TIME	USAGE TIME	MODE	PAGES	RESULT	*CODE
01	3332222	Jan. 21 02:14PM	00'45	SND	01	OK	
02	9998765	Jan. 21 03:17PM	00'58	RCV	02	OK	
03	John	Jan. 21 05:18PM	00'48	RCV	01	OK	
04	555556677	Jan. 22 10:35AM	02'45	SND	03	COMMUNICATION ERROR	(43)
05			02'50	SND	05	OK	
				RCV	03	OK	

Communication message (p. 56)

Error code (for service personnel use only)

Note:

- You can also print a journal report manually (p. 64).

Sending Faxes

Delayed transmission (sending a fax at a specified time)

Using a built-in clock, this unit can send documents automatically at a specified time. This allows you to take advantage of low-cost calling hours offered by your telephone company. The delayed transmission can be reserved to take place up to 24 hours in advance.

- 1 Insert the document FACE DOWN until the unit grabs the document and a single beep is heard.

Display: STANDARD

- 2 Press **MENU**.

Display: SYSTEM SET UP

- 3 Press **☐**, then **2** **5**.

DELAYED SEND

- 4 Press **START/COPY/SET**.

MODE=OFF ▼▲

- 5 Press ▼ or ▲ to select "ON".

MODE=ON ▼▲

- 6 Press **START/COPY/SET**.

FAX=

- 7 Enter the fax number using the dial keypad, the One-Touch Dial or the Speed Dial.

- 8 Press **START/COPY/SET**.

TIME=12:00AM

- 9 Enter the transmission start time. Press ***** to select "AM" or "PM".

Example (using the dial keypad): 11:30PM

Press **1** **1** **3** **0**, then press ***** until "PM" is displayed.

TIME=11:30PM

- 10 Press **START/COPY/SET**.

SETUP ITEM []

- 11 Press **MENU**.

SEND AT 11:30PM

- At the programmed time, the unit will automatically start transmission.

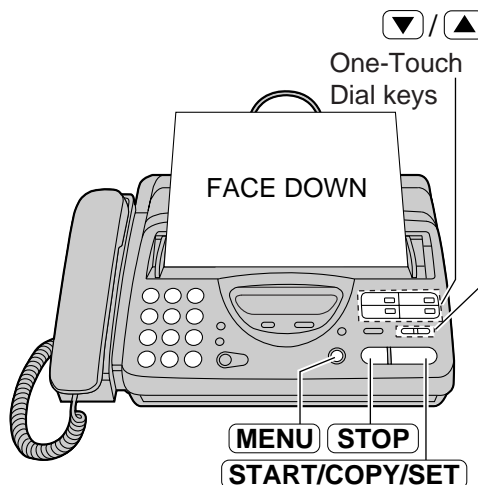

Note:

- You can receive, transmit and copy documents while delayed transmission is set.
- When transmit polling (p. 37) is set to "ON", delayed transmission is not possible.

■ To cancel the delayed transmission setting

1. Press **STOP** while the unit is idle.

Display: SEND CANCELED ?



YES: PRESS SET

2. Press **START/COPY/SET**.

Transmit polling (letting another machine retrieve a fax on your unit)

This feature allows another person to call your unit to retrieve a document loaded on your unit. This saves you the call charges. This feature will not work when the unit is set to the TEL mode.

- 1 Insert the document **FACE DOWN** until the unit grabs the document and a single beep is heard.

Display: STANDARD

- 2 Press **MENU** five times.

POLLED

- 3 Press **START/COPY/SET**.

MODE=OFF ▼▲

- 4 Press ▼ or ▲ to select "ON".

MODE=ON ▼▲

- 5 Press **START/COPY/SET**.

POLLED ON

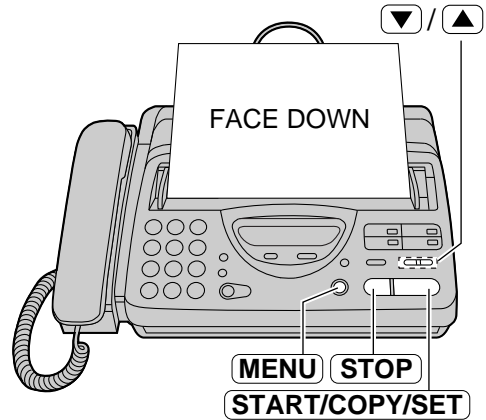

Note:

- The caller pays for the document transmission.
- When delayed transmission (p. 36) is set to "ON", transmit polling is not possible.

■ To cancel the transmit polling

1. Press **STOP** while the unit is idle.

Display: CANCEL POLLED



YES: PRESS SET

2. Press **START/COPY/SET**.

Sending Faxes

Overseas mode

You may experience difficulty when transmitting documents overseas. This feature makes sending documents easier as the transmission speed is slowed down. Before starting transmission, follow the steps below.

1 Press **MENU**.
Display: SYSTEM SET UP

2 Press **⇨**, then **2** **3**.
OVERSEAS MODE

3 Press **START/COPY/SET**.
MODE=OFF ▼▲

4 Press ▼ or ▲ to select "ON".
MODE=ON ▼▲

- If this feature is not required, select "OFF".

5 Press **START/COPY/SET**.
SETUP ITEM []

6 Press **MENU**.

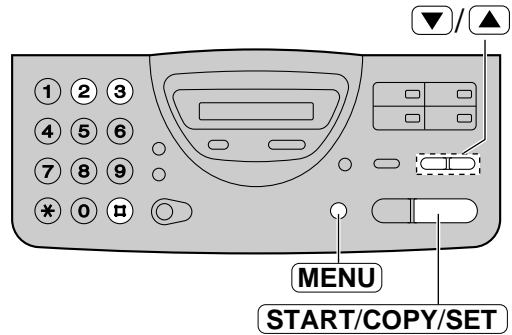

Note:

- After transmission, this feature will turn off automatically.
- A slower transmission speed will lengthen the call duration. Therefore the calling charges may be higher.

Connecting tone

This feature allows you to hear connecting tones, such as a fax tone, ring back tone or busy tone for several seconds when you send a fax using the One-Touch Dial or the Speed Dial. This will tell you the status of the other party's machine.

If you hear a:

- Fax tone: The other party's machine is ready for reception.
- Ring back tone: If this tone continues, the other party's machine may not be a facsimile or may have run out of paper. Check with the other party.
- Busy tone: The other party's machine is busy. Let the unit continue redialling or press **STOP** and try again later.

This feature is set to "ON" as a pre-selected setting. If this feature is not required, you can turn it off.

1 Press **MENU**.
Display: SYSTEM SET UP

2 Press **7 6**.
CONNECTING TONE

3 Press **START/COPY/SET**.
MODE=ON ▼▲

4 Press ▼ or ▲ to select the desired setting.
● If this feature is not required, select "OFF".

5 Press **START/COPY/SET**.
SETUP ITEM []

6 Press **MENU**.

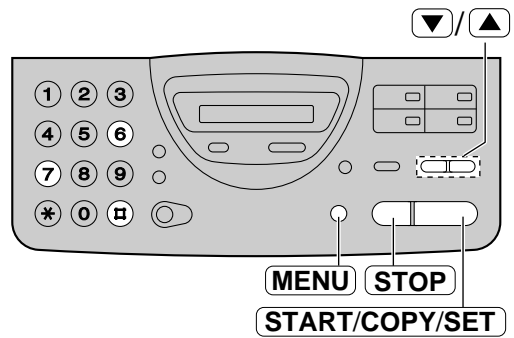

Note:

- The connecting tone volume cannot be adjusted.

Receiving Faxes

Setting the unit to receive calls

Option A

Option B

How you want the unit to receive calls

To answer all voice and fax calls yourself.



Voice/Fax call

You have a separate telephone line just for fax calls.



Fax call

TEL mode

(p. 42)

FAX ONLY mode

(p. 43, 44)

PRE-SELECTED SETTING

You have to set this.

When the unit is in the TEL mode, the arrow indicator on the display points to "TEL".

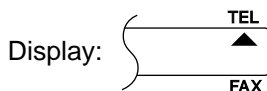

- If the arrow indicator(s) point(s) to "FAX" or both "TEL" and "FAX", press **RECEIVE MODE**.

When the unit is in the FAX ONLY mode, the arrow indicator on the display points to "FAX".

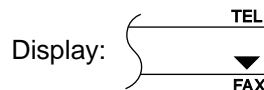

- If the arrow indicator points to "TEL", press **RECEIVE MODE**.

This is how the unit will operate.

When the unit rings, you must answer all calls.

- If you hear a fax calling tone (slow beep) or no sound is heard, press **START/COPY/SET**.

All incoming calls will be answered as faxes, and the unit will try to receive a fax.

Other options

TEL/FAX mode

If you are near the unit and want to use it to receive your voice calls yourself and fax calls automatically, see pages 48 to 51.

Remote activation

If you answer a telephone in another room and hear the fax tone, you can activate the unit remotely by pressing * * * 9 (p. 45).

Receiving Faxes

TEL mode --- --- (answering all calls manually)

If the arrow indicator(s) point(s) to "FAX" or both "TEL" and "FAX", press **RECEIVE MODE**.

- The display will show the following.

Display: TEL MODE

- 1** When the unit rings, lift the handset to answer the call.
- 2** When:
 - document reception is required,
 - a fax calling tone (slow beep) is heard, or
 - no sound is heard,press **START/COPY/SET**.

CONNECTING.....

- 3** Replace the handset.
 - The unit will start reception.

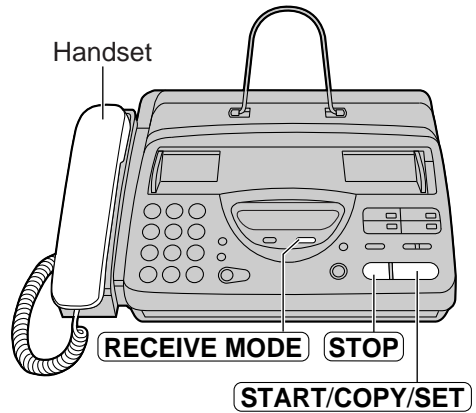

Note:

- If you do not answer the call within 15 rings, the unit will temporarily switch to the fax and the caller can send a document.

■ To stop receiving

Press **STOP**.

■ Friendly reception feature

When you answer a call and hear a fax calling tone (slow beep), the unit will automatically start receiving.

- If this feature is not required, set to "OFF" (p. 52).

FAX ONLY mode ===== (all calls are received as faxes)

Activating the FAX ONLY mode

If the arrow indicator points to "TEL", press **RECEIVE MODE**.

- The display will show the following.

Display: FAX ONLY MODE

- The unit will automatically answer all calls and only receive fax documents.
- The number of rings before a call is answered can be changed (p. 44).

Note:

- This mode should not be used with a telephone line which is used for both voice and fax calls. When the unit answers the call, fax communication is attempted with the other fax machine even if someone is trying to call you.

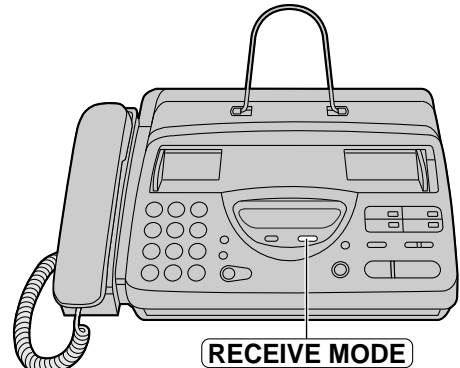

■ If you have a telephone line just for receiving faxes, we recommend the following setup.

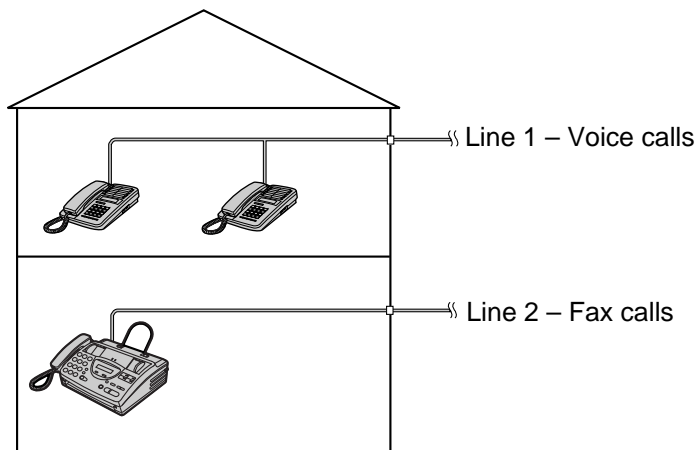

Only a fax machine is connected.

Example: One telephone line is used for voice calls and a separate telephone line for faxes. If someone sends a fax to Line 2, the fax machine will ring.

Receiving Faxes

FAX ONLY mode ring count

This setting determines the number of rings before the unit answers a call in the FAX ONLY mode. You can choose from 1 to 4 rings.

Helpful hints:

- To answer a call before the unit does, increase the number of rings.
- If you have difficulty receiving faxes, the other parties may have tried to send faxes before confirming if your unit answered or not. Decrease the number of rings.

1 Press **MENU**.
Display: SYSTEM SET UP

2 Press **#**, then **0 7**.
FAX RING COUNT

3 Press **START/COPY/SET**.
RING=1 ▼▲

4 Press ▼ or ▲ to select the desired number.

5 Press **START/COPY/SET**.
SETUP ITEM []

6 Press **MENU**.

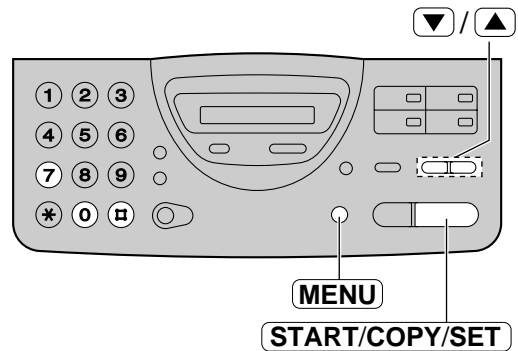

Extension telephone

If you connect an extension telephone to your unit or on the same line, you can receive fax documents using the extension telephone.

You do not have to press **START/COPY/SET** on the unit.

Important:

- Use a touch tone telephone as the extension telephone and enter the fax activation code **firmly**.

- 1** When the extension telephone rings, lift the handset of the extension telephone.
- 2** When:
 - document reception is required,
 - a fax calling tone (slow beep) is heard, or
 - no sound is heard,press *** * * 9** (pre-selected fax activation code) **firmly**.
- 3** Replace the handset.
 - The unit will start reception.

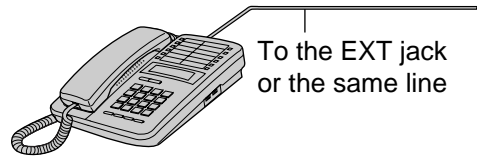

Note:

- You can change the fax activation code (see below).

Fax activation code

The fax activation code is used when receiving faxes using an extension telephone (see above).

Important:

- This code should be different from the remote access code of your answering machine.

- 1** Press **MENU**.
Display:

- 2** Press **▣**, then **4 1**.

- 3** Press **START/COPY/SET**.
 ▼▲

- 4** Press ▼ or ▲ to select "ON".
 - If this feature is not required, select "OFF".

- 5** Press **START/COPY/SET**.

- The display will show the pre-selected code.

- 6** Enter the new code number.
 - This code can be from 2 to 4 digits in length using 0–9 and *.

- 7** Press **START/COPY/SET**.

- 8** Press **MENU**.

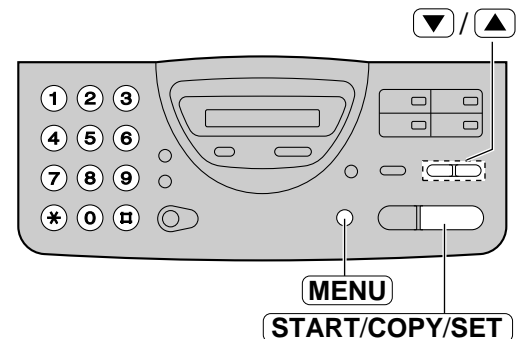

Note:

- If you subscribe to any special telephone company services which require a code, all or part of the fax activation code must be different from the service access code.
- The fax activation code should not be set to "0000".

Receiving Faxes



Receiving with a duplex ring service --- ---

This feature can only be used when you subscribe to a duplex ring service from your telephone company. For more information on the availability of this service, contact your telephone company before activating this feature.

What is a duplex ring service?

A duplex ring service will give you an additional telephone number on a single telephone line, having a different ringing pattern (single bell).

Ring patterns:

Single bell (one long ring)	
Double bell (two short rings)	

When you subscribe to a duplex ring service, you can assign telephone numbers for telephone number and fax telephone number.

When a call is received, you will know which number is being called by the ringing pattern.

Example:

Your telephone number	Ring pattern	Use
012 1234	Double ring	Telephone
012 5678	Single ring	Facsimile

To use one of the telephone numbers as a facsimile number

Set the ring pattern detection feature to ON.

When the unit detects a call with a single bell pattern, it will activate the fax function.

Setting the ring pattern detection

- 1** Press **MENU**.
Display: SYSTEM SET UP
- 2** Press **3**, then **1**.
RING DETECTION
- 3** Press **START/COPY/SET**.
MODE=OFF ▼▲
- 4** Press ▼ or ▲ to select the "ON".
MODE=ON ▼▲
 - If this feature is not required, select "OFF".
- 5** Press **START/COPY/SET**.
PRINTING
 - The unit will print an information list.
SETUP ITEM []
- 6** Press **MENU**.

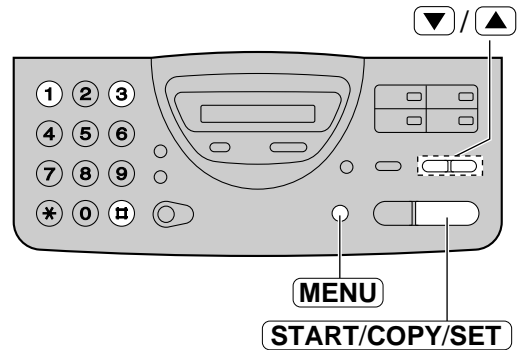

How the unit will answer in each receive mode

When a single bell is detected, the unit will automatically answer the call and activate the fax function.

- TEL mode:** When a double bell is received, the unit will ring 15 times and temporarily activate the fax function.
- FAX ONLY mode:** The unit automatically answers a distinctive ring call after the second ring. To change the number of rings, change the FAX ONLY mode ring count (p. 44) after setting the ring pattern.
- TEL/FAX mode:** When a double bell is received, the unit will ring until you answer the call.

Receiving Faxes

TEL/FAX mode (receiving voice calls with rings and fax calls without rings when you are near the unit)

Use this mode when you are always near the unit, are not using an answering machine and want the fax machine to detect faxes without ringing. When a call is received, the unit will work as follows. If you connect an extension telephone to the same line, see the next page.

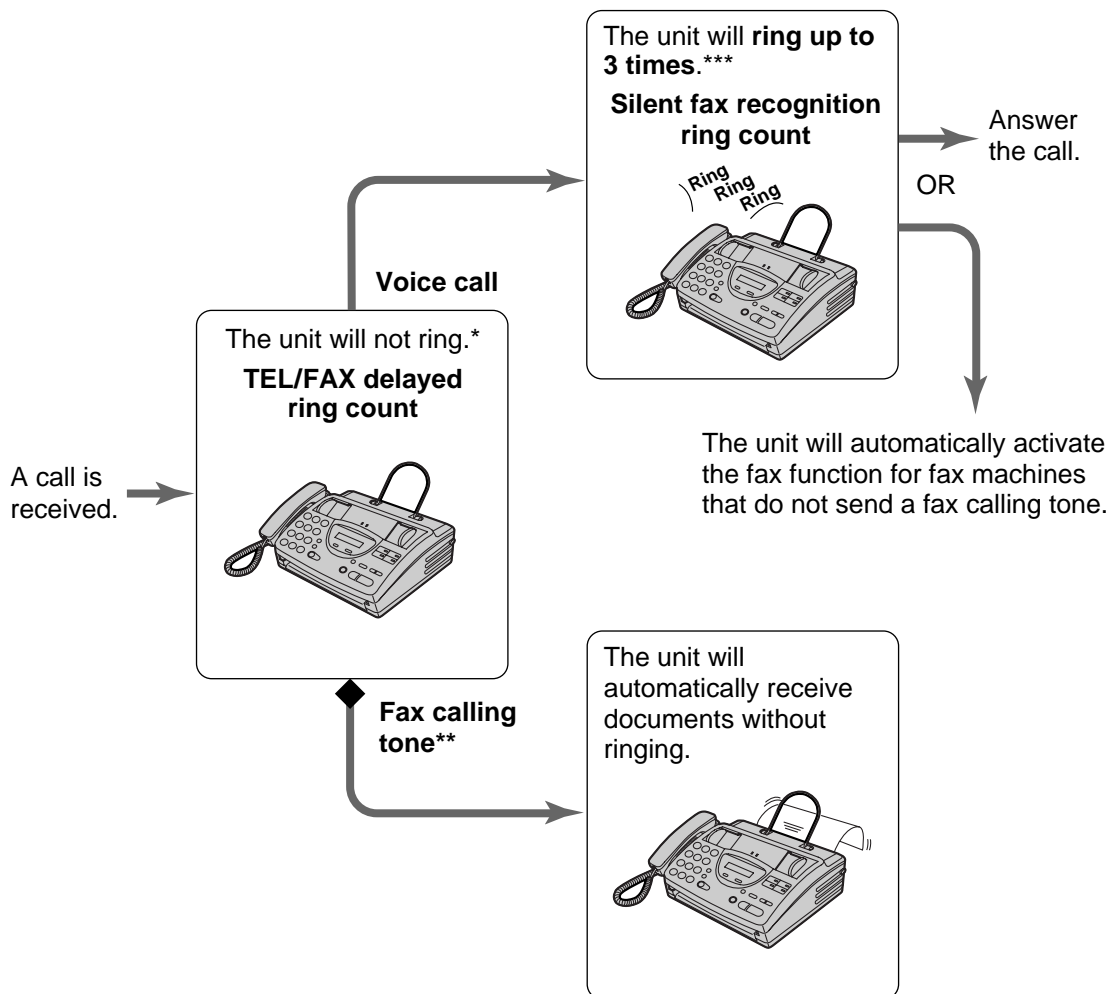

* A telephone fee will be charged to the caller from this point.

** A fax calling tone is automatically generated by the sending fax machine. Some fax machines do not have this capability.

*** While ringing, the unit will emit a different ring back tone to the calling party.

Note:

● The unit will display the following when a call is received.

Display: INCOMING CALL

- Some fax messages that are transmitted manually may not send a fax calling tone. These calls must be received manually.
- The ringer should be on (p. 23).

Ring pattern when an extension telephone is connected

If you absolutely must use another phone on the same phone line, you can disengage the TEL/FAX mode on a call by call basis by pressing *0 before the fax machine begins communicating. Once the fax machine is activated, the only way to turn it off is by pressing the **STOP** button on the unit.

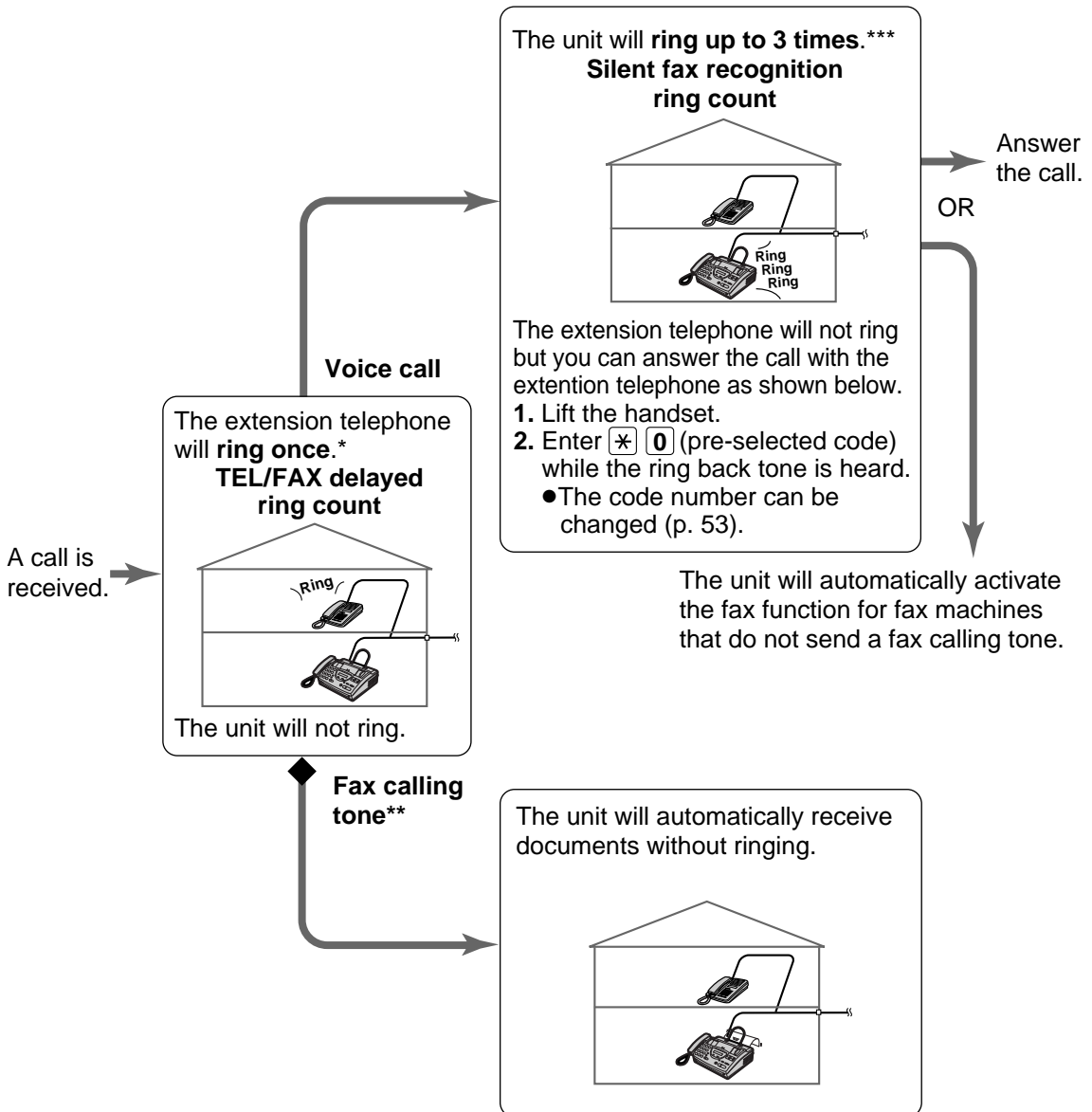

TEL/FAX delayed ring count:

Up to 4 ring signals will be generated before the unit answers, depending on feature setting #78 on page 51. In the TEL/FAX mode, the unit will not generate an audible ring during this time.

Silent fax recognition ring count:

The unit generates audible rings to indicate that it is receiving a voice call. 3 to 9 rings will be generated, depending on feature setting #30 on page 51. This signal will not ring at an extension telephone.

Receiving Faxes

Changing the AUTO ANSWER setting to the TEL/FAX mode

1 Press **MENU**.
Display: SYSTEM SET UP

2 Press **Ⓜ**, then **7 7**.
AUTO ANSWER

3 Press **START/COPY/SET**.
MODE=FAX ONLY ▼▲

4 Press ▼ or ▲ to select "TEL/FAX".
MODE=TEL/FAX ▼▲

5 Press **START/COPY/SET**.
SETUP ITEM []

6 Press **MENU**.

7 If the arrow indicator on the display points to "TEL", press **RECEIVE MODE**.
TEL/FAX MODE

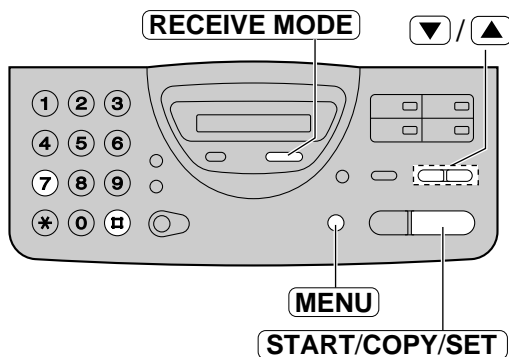

Note:

- To return to the FAX ONLY mode, select "FAX ONLY" in step 4.
- In the TEL/FAX mode, the display will show the following.

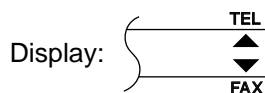

■ We recommend the following setup.

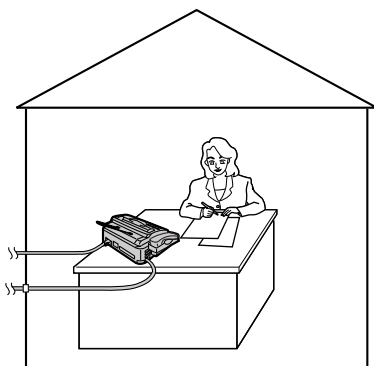

Only a fax machine is connected and you are always near the fax machine.

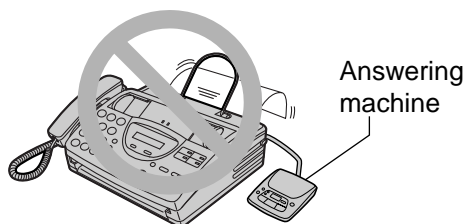

- Do not connect an answering machine when using the TEL/FAX mode.

TEL/FAX delayed ring count

This setting determines the number of times the extension telephone rings in the TEL/FAX mode. You can choose from 1 to 4 rings.

This setting does not need to be changed if an extension telephone is not connected.

- 1 Press **MENU**.
Display: **SYSTEM SET UP**
- 2 Press **☐**, then **7 8**.
TEL/FAX RING
- 3 Press **START/COPY/SET**.
RING=1 ▼▲
- 4 Press ▼ or ▲ to select the desired number.
- 5 Press **START/COPY/SET**.
SETUP ITEM []
- 6 Press **MENU**.

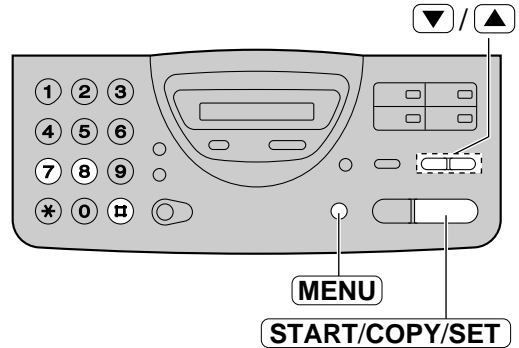

Note:

- If the number of rings is increased, you may not be able to receive documents from some older model fax machines which do not send a fax calling tone.

Silent fax recognition ring count

When the unit detects a voice call in the TEL/FAX mode, it will ring up to 3 times. The number of rings can be changed up to 9.

- 1 Press **MENU**.
Display: **SYSTEM SET UP**
- 2 Press **☐**, then **3 0**.
SILENT FAX RING
- 3 Press **START/COPY/SET**.
RING=3 ▼▲
- 4 Press ▼ or ▲ to select the desired number.
- 5 Press **START/COPY/SET**.
SETUP ITEM []
- 6 Press **MENU**.

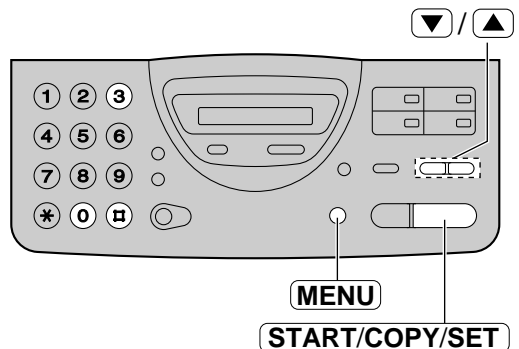

Note:

- If the number of rings is increased, you may not be able to receive documents from some older model fax machines which do not send a fax calling tone.

Receiving Faxes

Receiving polling --- --- (receiving a fax placed on another party's machine)

This feature allows you to retrieve a document from another compatible machine. Therefore, you pay for the call, saving the sending party the call charges.

Make sure that no documents are fed into your unit and that the other party's machine is ready for your call.

1 Press **MENU** four times.
Display:

2 Press **START/COPY/SET**.

3 Dial the fax number.
Example:

4 Press **START/COPY/SET**.

- The unit will start reception.

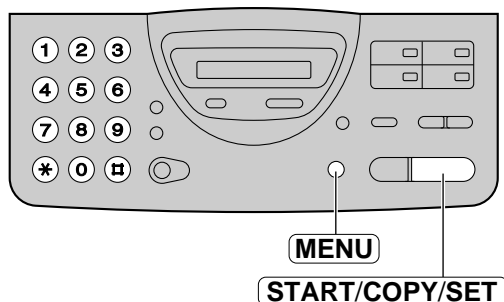

Friendly reception --- ---

The friendly reception feature allows you to receive fax documents automatically without pressing **START/COPY/SET** (p. 42).

When this feature is deactivated, you have to press **START/COPY/SET** to receive fax documents each time you answer a fax call.

1 Press **MENU**.
Display:

2 Press **#**, then **4** **6**.

3 Press **START/COPY/SET**.

4 Press ▼ or ▲ to select the desired setting.
• If this feature is not required, select "OFF".

5 Press **START/COPY/SET**.

6 Press **MENU**.

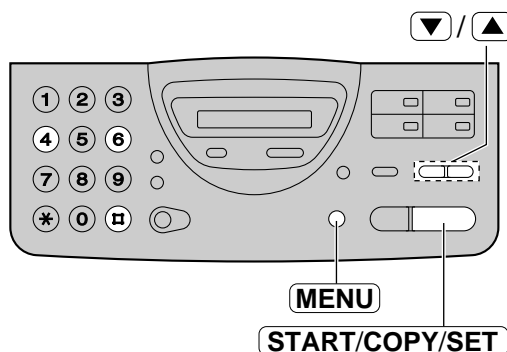

Auto disconnection

This feature allows you to answer a call with the extension telephone during the silent fax recognition rings in the TEL/FAX mode (p. 49). When you lift the handset of the extension telephone and enter *0 (pre-selected code) while the ring back tone is heard, the unit will be disconnected and you can talk with the other party.

Important:

- This code should be different from the fax activation code (p. 45) and the remote access code of your answering machine.

1 Press **MENU**.
Display: SYSTEM SET UP

2 Press **4 9**.
AUTO DISCONNECT

3 Press **START/COPY/SET**.
MODE=ON ▼▲

4 Press ▼ or ▲ to select "ON".
• If this feature is not required, select "OFF".

5 Press **START/COPY/SET**.
CODE=*0

- The display will show the pre-selected code.

6 Enter the new code.
• This code can be from 2 to 4 digits in length using 0–9, and *.

7 Press **START/COPY/SET**.
SETUP ITEM []

8 Press **MENU**.

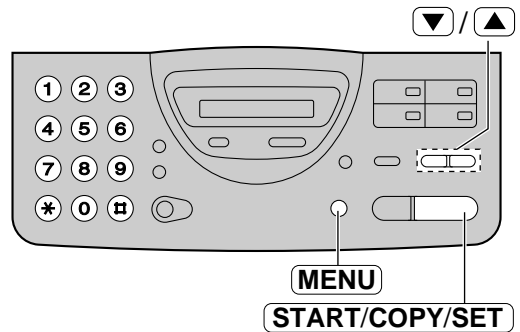

Receiving Faxes

Pager call - when your unit receives a fax

This feature allows your unit to call your pager when your unit receives a fax document.

1 Press **MENU**.
Display: SYSTEM SET UP

2 Press **7 0**, then **7 0**.
FAX PAGER CALL

3 Press **START/COPY/SET**.
MODE=OFF

4 Press **▼** or **▲** to select "ON".
MODE=ON

- If this feature is not required, select "OFF".

5 Press **START/COPY/SET**.
NO. =

6 Enter your pager number.
• You can enter a total of 46 digits and/or pauses.

Example:

1 202 555 1234 PPP 12345678 PPP 5555 #

Your pager number

Pauses

Your pager access code, if required.

Message you want displayed on your pager when your unit receives a fax.

7 Press **START/COPY/SET**.
SETUP ITEM []

8 Press **MENU**.

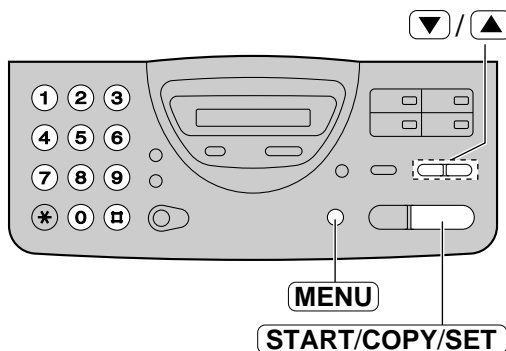

Note:

- Message programming methods may vary depending on the pager company. Contact your pager company for details.

■ How your unit and pager work

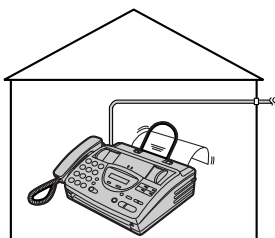

When your unit receives a fax document, it will call your pager company.

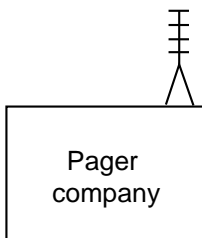

Your pager company will call your pager.



A few minutes later, your pager will display the same message you entered in step 6. (For example: 5555).

Making a copy

Any transmittable document (p. 33) can be copied.

- 1 Check that the document stacker is in the upright position.
- 2 Adjust the width of the document guides to the size of the document.
- 3 Insert the document (up to 10 pages) FACE DOWN until the unit grabs the document and a single beep is heard.

Display:

- Make sure the handset is on the cradle.

- 4 If necessary, press **RESOLUTION** repeatedly to select the desired setting (p. 31).

- 5 Press **START/COPY/SET**.
 - The unit will start printing.

Note:

- If a resolution is not selected, FINE resolution will automatically be selected.
- You can make or receive a voice call while making copies.
- When you copy a multiple page document which is longer than A4 size paper (approx. 300 mm), we recommend you insert one page at a time.

■ To stop copying

Press **STOP**.

To eject the document, press **STOP** again.

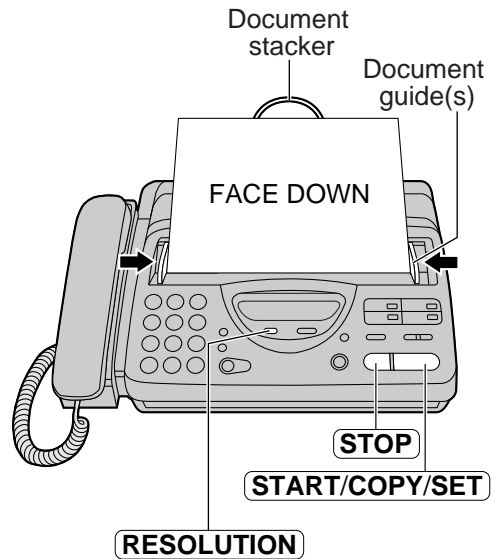

Error Messages

Reports

If your unit cannot send a fax, check the following.

- The number you dialled is correct.
- The other party's machine is a facsimile.

If the problem remains, correct it by following the communication message printed on the sending and journal reports (p. 34, 35).

Communication message	Error code	Cause & Remedy
COMMUNICATION ERROR	41–72 FF	<ul style="list-style-type: none">● A transmission or reception error occurred. Try again or check with the other party.
DOCUMENT JAMMED	—	<ul style="list-style-type: none">● The document is jammed. Remove the jammed document (p. 62).
ERROR-NOT YOUR UNIT	53, 54, 59, 70	<ul style="list-style-type: none">● A transmission or reception error occurred because of a problem with the other party's fax machine. Check with the other party.
NO DOCUMENT	—	<ul style="list-style-type: none">● The document was not fed into the unit properly. Reinsert the document and try again.
OTHER FAX NOT RESPOND	—	<ul style="list-style-type: none">● The other party's fax machine was busy or ran out of recording paper. Try again.● The document was not fed properly. Reinsert the document and try again.● The other party's fax machine rings too many times. To send a fax manually, dial the number, confirm the fax tone, and press the START/COPY/SET button.● The other party's machine is not a facsimile. Check with the other party.● The number you dialled is not in service.
PAPER OUT	—	<ul style="list-style-type: none">● The unit ran out of recording paper. Install a recording paper roll (p. 17).● The cover was opened. Close it and try again.
PRESSED THE STOP KEY	—	<ul style="list-style-type: none">● The STOP button was pressed and fax communication was cancelled.
PRINTER OVERHEATED	—	<ul style="list-style-type: none">● The printer overheated. Let the unit cool down.
OK	—	<ul style="list-style-type: none">● Fax communication was successful.

LCD display

If the unit detects a problem, one or more of the following messages will appear on the display.

Display message	Cause & Remedy
CALL SERVICE 1	<ul style="list-style-type: none"> There is something wrong with the unit. Contact our service personnel.
CALL SERVICE 2	
CHECK COVER	<ul style="list-style-type: none"> The cover is open. Close it.
CHECK DOCUMENT	<ul style="list-style-type: none"> The document is not fed into the unit properly. Reinsert the document. If misfeeding occurs frequently, clean the document feeder rollers and try again (p. 63). If the problem remains, adjust the feeder pressure (p. 62). Attempted to transmit a document longer than 600 mm. Press the STOP button to remove the document. Divide the document into two or more sheets and try again.
CHECK MEMORY	<ul style="list-style-type: none"> Memory (telephone numbers, parameters, etc.) has been erased. Re-program.
NO RESPONSE	<ul style="list-style-type: none"> The other party's fax machine is busy or ran out of recording paper. Try again.
OUT OF PAPER	<ul style="list-style-type: none"> The unit ran out of recording paper. Install a recording paper roll (p. 17).
POLLING ERROR	<ul style="list-style-type: none"> The other party's fax machine does not have a polling feature. Check with the other party.
REDIAL TIME OUT	<ul style="list-style-type: none"> The other party's fax machine is busy or ran out of recording paper. Try again.
REMOVE DOCUMENT	<ul style="list-style-type: none"> The document is jammed. Remove the jammed document (p. 62).
TRANSMIT ERROR	<ul style="list-style-type: none"> A transmission error occurred. Try again.
UNIT OVERHEATED	<ul style="list-style-type: none"> The unit is too hot. Let the unit cool down.

Operations

When a function does not work, check here before requesting help

General

Problem	Cause & Remedy
I cannot make and receive calls.	<ul style="list-style-type: none">● The power cord or telephone line cord is not connected. Check the connections (p. 18).
I cannot make calls.	<ul style="list-style-type: none">● The dialling mode setting is wrong. Change to "TONE" or "PULSE" (p. 18).
The unit does not work.	<ul style="list-style-type: none">● Disconnect the unit from the telephone line and connect the line to a known working telephone. If the working telephone operates properly, contact our service personnel to have the unit repaired. If the working telephone does not operate properly, contact your telephone company.
The unit does not ring.	<ul style="list-style-type: none">● The ringer volume is set to off. Adjust it to a suitable level (p. 23).
The other party complains they only hear a fax tone and cannot talk.	<ul style="list-style-type: none">● The FAX ONLY mode is set. Tell them the number is only used for faxes or change to another mode (p. 40, 41).
The REDIAL/PAUSE button does not function properly.	<ul style="list-style-type: none">● If this button is pressed during dialling, a pause will be inserted. If pressed immediately after a dial tone is obtained, the last number dialled will be redialled.
The receive mode does not function as explained on page 40.	<ul style="list-style-type: none">● A ring pattern detection is set (p. 46, 47).● The TEL/FAX mode is set (p. 48–51).
During programming, I cannot enter the fax activation code.	<ul style="list-style-type: none">● All or part of the numbers are the same as the remote access code of your answering machine. Change the number (p. 45).

Fax – sending

Problem	Cause & Remedy
I cannot send documents.	<ul style="list-style-type: none">● The telephone line cord is connected to the EXT jack on the unit. Connect to the LINE jack (p. 18).● The other party's fax machine was busy or ran out of paper. Try again.● The other party's machine is not a facsimile. Check with the other party.● The other party's fax machine rings too many times. Send the fax manually - dial the number, confirm the fax tone, then press the START/COPY/SET button.
The other party complains that letters on their received document are distorted.	<ul style="list-style-type: none">● If your line has special telephone services such as call waiting, the service may have been activated during fax transmission. Connect the unit to a line that does not have these services.● The extension telephone on the same line is off the hook. Hang up the extension telephone and try again.

Fax – sending (cont.)

Problem	Cause & Remedy
The other party complains that dirty patterns or black lines appear on their received document.	<ul style="list-style-type: none"> ● The glass or rollers are dirty. Clean them (p. 63).
I cannot make an international fax call.	<ul style="list-style-type: none"> ● Use the overseas transmission mode (p. 38). ● Add two pauses at the end of the telephone number (p. 26). ● Dial the number manually.

Fax – receiving

Problem	Cause & Remedy
I cannot receive documents.	<ul style="list-style-type: none"> ● The telephone line cord is connected to the EXT jack on the unit. Connect to the LINE jack (p. 18).
I cannot receive documents automatically.	<ul style="list-style-type: none"> ● The receive mode is set to the TEL mode. Set to the FAX ONLY or TEL/FAX mode. ● The time taken to answer the call is too long. Decrease the number of rings (p. 44, 51).
The display shows “CONNECTING.....” but faxes are not received.	<ul style="list-style-type: none"> ● The incoming call is not a fax. Change the receive mode to the TEL mode.
The recording image is faint.	<ul style="list-style-type: none"> ● The sender transmitted a faint document. Ask them to transmit a clearer copy of the document. ● The thermal head is dirty. Clean it (p. 63).
The received document is blank.	<ul style="list-style-type: none"> ● The recording paper roll is installed incorrectly. Make sure that the shiny side of the paper is facing down and re-install the paper (p. 17).

Receive mode

Problem	Cause & Remedy
I cannot select the desired receive mode.	<ul style="list-style-type: none"> ● If you want to set the FAX ONLY or TEL/FAX mode: <ul style="list-style-type: none"> — Select the desired mode using feature #77 (p. 50), and — Press (RECEIVE MODE) repeatedly until the desired mode is displayed. ● If you want to set the TEL mode: <ul style="list-style-type: none"> — Press (RECEIVE MODE) repeatedly until the TEL mode is displayed.

Operations

Copying

Problem	Cause & Remedy
The unit does not make a copy.	<ul style="list-style-type: none">● You cannot make a copy during programming. Make the copy after programming or stop the programming.
A dirty pattern or a black line appears on the copied document.	<ul style="list-style-type: none">● The glass or rollers are dirty. Clean them (p. 63).
The copied image is distorted.	<ul style="list-style-type: none">● The thermal head is dirty. Clean it (p. 63).
The copied document is blank.	<ul style="list-style-type: none">● The recording paper roll is installed incorrectly. Make sure that the shiny side of the paper is facing down and re-install the paper (p. 17).

If a power failure occurs --- ---

- The unit will not function.
- Voice and fax calls will be interrupted.
- If delayed transmission is programmed and the start time has passed during a power failure, transmission will be attempted soon after power is restored.

Recording paper jam

If the unit does not eject any recording paper during reception or copying, the recording paper has jammed. Remove the jammed paper as shown below.

- 1 Open the cover by pressing the cover open button and remove the recording paper roll.

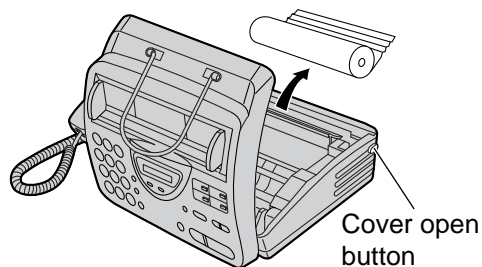

- 2 Replace the recording paper roll in the proper direction, and pull the leading edge of the paper approximately 10 cm (4 inches) out of the unit.

- Make sure that there is no slack in the paper roll.

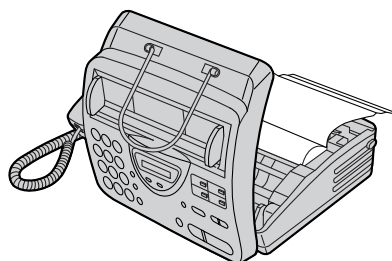

- 3 Close the cover securely by pushing down on both ends.

- A message will be printed on the recording paper.
- If the recording paper is set to the wrong side, the message will not be printed. Install the paper correctly.

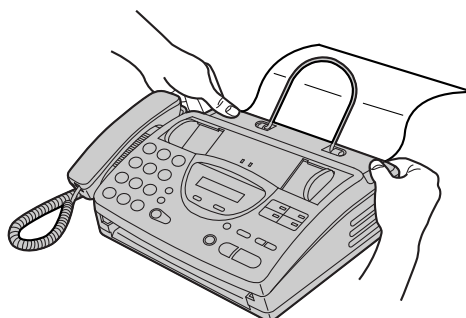

- 4 Pull down the document stacker and tear off the excess paper by pulling it towards you, then push the stacker to the upright position.

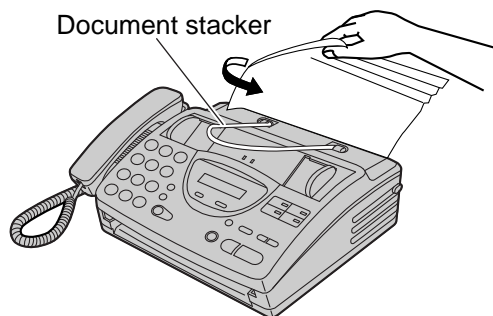

Jams

Document jam

If the unit does not release the document during feeding, remove the jammed document as follows.

- 1 Open the cover by pressing the cover open button.
- 2 Remove the jammed document carefully.
- 3 Close the cover securely by pushing down on both ends.

Note:

- Do not pull out the jammed paper forcibly before opening the cover.

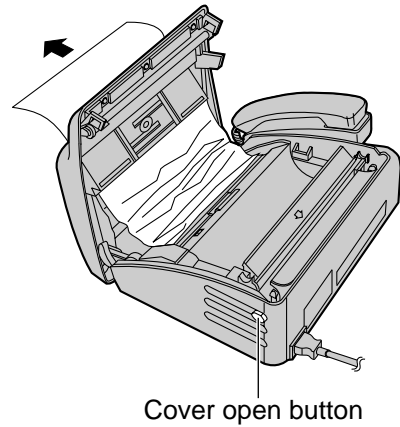
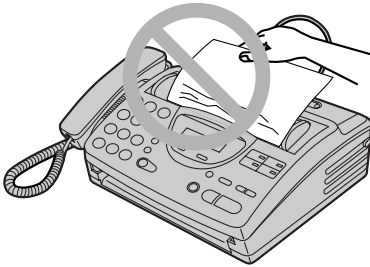

Sending document does not feed, or multi-feeds

If no feeding or multiple feeding occurs frequently, adjust the feeder pressure.

- 1 Open the cover by pressing the cover open button.
- 2 Shift the position of the lever using an instrument with a pointed end, such as a paper clip.
Right: When documents do not feed.
Center: Standard position (pre-selected)
Left: When documents multiple feed.
- 3 Close the cover securely by pushing down on both ends.

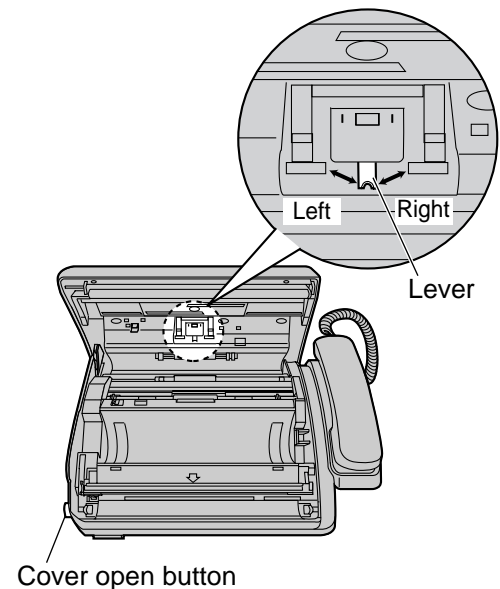

Document feeder

If misfeeding occurs frequently or if dirty patterns or black bands appear on a copied or transmitted document, clean the document feeder.

- 1** Disconnect the power cord and the telephone line cord.
- 2** Open the cover by pressing the cover open button.
- 3** Clean the document feeder rollers, sub roller and rubber flap with a cloth moistened with isopropyl rubbing alcohol, and let all parts dry thoroughly.
- 4** Clean the white plate and glass with a soft dry cloth.
- 5** Close the cover securely by pushing down on both ends.
- 6** Connect the power cord and the telephone line cord.

Caution:

- Do not use paper products, such as paper towels or tissues, to clean the inside of the unit.

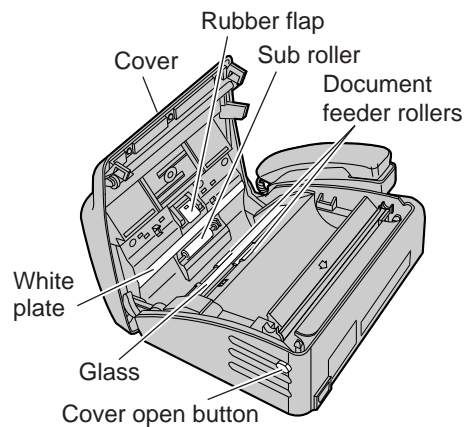
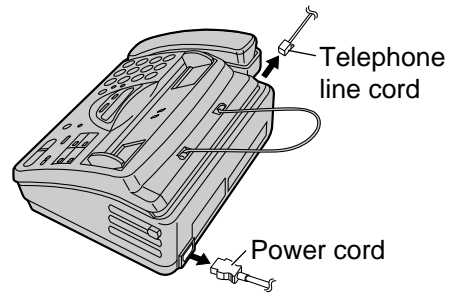

Thermal head

If dirty patterns or black bands appear on a copied or received document, clean the thermal head.

- 1** Disconnect the power cord and the telephone line cord.
- 2** Open the cover by pressing the cover open button.
- 3** Clean the thermal head with a cloth moistened with isopropyl rubbing alcohol, and let it dry thoroughly.
- 4** Close the cover securely by pushing down on both ends.
- 5** Connect the power cord and the telephone line cord.

Caution:

- To prevent a malfunction due to static electricity, do not use a dry cloth and do not touch the thermal head directly with your fingers.

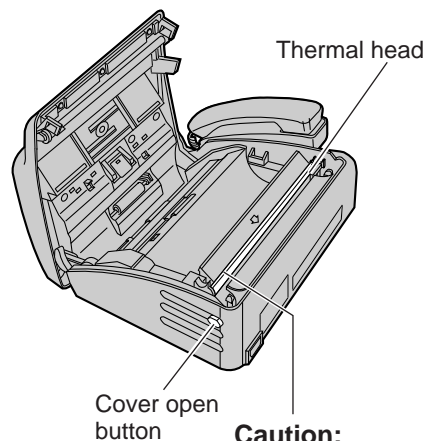

Caution:

- Do not push on the black cover.

Print Reports

Printing the feature settings, telephone numbers, journal

You can print out the following documents.

Basic feature list: provides you with the current settings of the basic programming features (p. 69).

Advanced feature list: provides you with the current settings of the advanced programming features (p. 69, 70).

Telephone number list: provides you with names and telephone numbers which are stored in the automatic dialling directory. The telephone number codes are as shown below.

P: A pause has been entered.

F: A flash has been entered.

[]: A secret telephone number has been entered. (The telephone number is not printed.)

Journal report: keeps records of fax transmissions and receptions. This report will be printed automatically after every 35 fax communications (p. 35).

1 Press **MENU** three times.

Display: PRINT REPORT

2 For the **basic feature list**, press **[#]**, then **1**.

BASIC LIST

For the **advanced feature list**, press **[#]**, then **2**.

ADVANCED LIST

For the **telephone number list**, press **[#]**, then **3**.

TEL NO. LIST

For the **journal report**, press **[#]**, then **4**.

JOURNAL REPORT

3 Press **START/COPY/SET** to start printing.

PRINTING

- To stop printing, press **STOP**.
- After printing, the following will be displayed.

PRINT ITEM []

4 Press **MENU**.

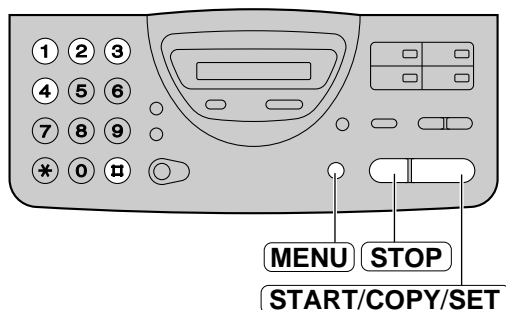

Setting the original mode

Use this feature when you need to transmit or copy a document with faint or dark writing. One of the following choices is available.

NORMAL: Used for documents with normal writing (Pre-selected setting).

LIGHT: Used for documents with faint writing.

DARKER: Used for documents with dark writing.

Set this feature before starting transmission or copying.

- 1 Press **MENU**.
Display: SYSTEM SET UP
- 2 Press **[]**, then **5** **8**.
ORIGINAL
- 3 Press **START/COPY/SET**.
MODE=NORMAL ▼▲
- 4 Press ▼ or ▲ to select the desired setting.
- 5 Press **START/COPY/SET**.
SETUP ITEM []
- 6 Press **MENU**.

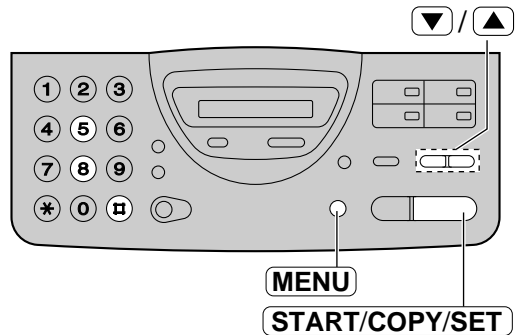

Note:

- This feature will return to the normal mode after transmission or copying is completed.
- These settings are available in the standard, fine and super fine resolutions.

Resetting the advanced features

Use this feature to return the advanced features (p. 69, 70) to their pre-selected settings.

- 1 Press **MENU**.
Display: SYSTEM SET UP
- 2 Press **[]**, then **8** **0**.
SET DEFAULT
- 3 Press **START/COPY/SET**.
RESET=NO ▼▲
- 4 Press ▼ or ▲ to select "YES".
RESET=YES ▼▲
- 5 Press **START/COPY/SET**.
RESET OK?

- 6 Press **START/COPY/SET** again for confirmation.

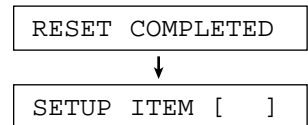

- 7 Press **MENU**.

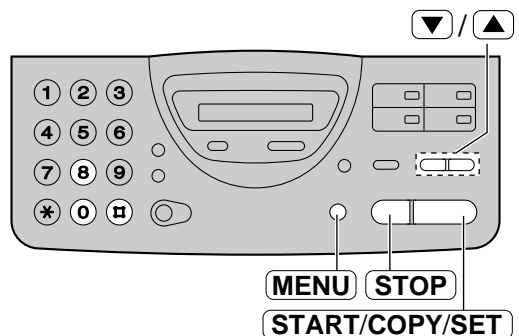

- If this feature is not required, press **STOP**.

Specifications

Technical data about this product

Applicable Lines:	Public Switched Telephone Network
Document Size:	Max. 216 mm (8½") in width Max. 600 mm (23⅝") in length
Effective Scanning Width:	208mm (8⅜")
Recording Paper Size:	216 mm x max. 30 m (8½" x 98') roll
Effective Printing Width:	208 mm (8⅜")
Transmission Time*:	Approx. 15 s/page (Original mode)** Approx. 30 s/page (G3 Normal mode)
Scanning Density:	Horizontal: 8 pels/mm (203 pels/inch) Vertical: 3.85 lines/mm (98 lines/inch) –STANDARD mode 7.7 lines/mm (196 lines/inch) –FINE/HALF TONE mode 15.4 lines/mm (392 lines/inch) –SUPER FINE mode
Halftone Level:	64-level
Scanner Type:	Contact Image Sensor (CIS)
Printer Type:	Thermal Printing
Data Compression System:	Modified Huffman (MH), Modified READ (MR)
Modem Speed:	9,600 / 7,200 / 4,800 / 2,400 bps; Automatic Fallback
Operating Environment:	5 °C – 35 °C (41 °F – 95 °F), 45 % – 85 % RH (Relative Humidity)
Dimensions (HxWxD):	122 mm x 338 mm x 240 mm (4⅜" x 13⅝" x 9⅞")
Mass (Weight):	Approx. 2.5 kg (5.5 lb.)
Power Consumption:	Standby: Approx. 5.5 W Transmission: Approx. 17 W Reception: Approx. 30 W (When receiving the CCITT No. 1 Test Chart) Copy: Approx. 30 W (When copying the CCITT No. 1 Test Chart) Maximum: Approx. 120 W (When copying a 100 % black document)
Power Supply:	220–240 V AC, 50/60 Hz

* Transmission speed depends upon the contents of the pages, resolution, telephone line conditions and capability of the other party's machine.

** The 15 second speed is based upon the CCITT No. 1 Test Chart.

CCITT No. 1 Test Chart



Note:

- Any details given in these instructions are subject to change without notice.
- The pictures and illustrations in these instructions may vary slightly from the actual product.

Index

- A** Accessories 12
 Advanced feature list 64
 Advanced features 69, 70
 (Resetting) 65
 Auto disconnection 53
- B** Basic feature list 64
 Basic features 69
- C** Character table 21
 Cleaning 63
 Connecting tone 39
 Connections 5, 18
 Copy 55
 COPY button 9, 55
- D** Date and time 19
 Delayed transmission 36
 Dialling mode 18
 DIRECTORY button 28, 29, 32
 Document feeder cleaning 63
 Document jam 62
 Document size 33, 66
 Document stacker 4, 17
 Duplex ring service 46, 47
- E** Electronic telephone directory 29
 Error messages 56, 57
 Extension telephone 45, 49
- F** Facsimile telephone number 22
 Fax activation code 45
 Fax auto redial 32
 FAX ONLY mode 40, 43, 44
 FAX ONLY ring count 44
 Fax pager 54
 Features summary 69, 70
 Feeder
 (Cleaning) 63
 (Jam) 62
 (Pressure) 62
 FLASH button 26
 Friendly reception 52
- H** Handset cord 5, 18
 Handset receiver volume 23
 HELP button 13
 HYPHEN key 21, 27
- I** INSERT key 20, 21
- J** Jams 61, 62
 Journal auto print 35
 Journal report 35, 64
- L** LCD display (Error messages) 57
 List
 (Advanced feature) 64
 (Basic feature) 64
 (Journal) 35, 64
 (Sending) 34
 (Telephone number) 64
 Location panel 14, 15
 Logo 20, 21
 LOWER key 27, 28, 32
- M** MONITOR button 24, 30
- O** One-Touch Dial
 (Making a voice call) 28
 (Sending faxes) 32
 (Storing) 27
 Original mode 65
 Overseas transmission mode 38
 Overview 16
- P** Pager call 54
 Paper jam 61, 62
 PAUSE button 26
 Polling
 (Receiving) 52
 (Transmitting) 37
 Power failure 60
 Power supply/cord 5, 18, 66
 Printing paper size 66
 Printing reports 64
 Problem solving 58–60
 Programmable features 69, 70
 Pulse 18
- R** RECEIVE MODE button .. 40, 42, 43, 50
 Receiving
 (Fax) 8, 42
 (Setting) 40, 41
 Recording paper 4, 17, 61
 Recording paper jam 61
 REDIAL button 24, 31

- Report
 - (Advanced feature)..... 64
 - (Basic feature)..... 64
 - (Journal)..... 35, 64
 - (Sending)..... 34
 - (Telephone numbers)..... 64
- Reset..... 65
- RESOLUTION button..... 31
- Ring count
 - (FAX ONLY)..... 44
 - (TEL/FAX)..... 51
- Ring pattern detection..... 46, 47
- Ringer volume..... 23
- S** SECRET key..... 27
- Sending
 - (Manually)..... 7, 31
 - (One-Touch Dial)..... 32
 - (Speed Dial)..... 32
- Sending document (Does not feed, or multi-feeds)..... 62
- Sending jam..... 62
- Sending report..... 34
- Set default..... 65
- Silent fax recognition ring..... 51
- Specifications..... 66
- Speed Dial
 - (Making a voice call)..... 28
 - (Sending faxes)..... 32
 - (Storing)..... 27
- Storing
 - (One-Touch Dial)..... 27
 - (Speed Dial)..... 27
- T** TEL mode..... 40, 42
- TEL/FAX delayed ring count..... 51
- TEL/FAX mode..... 48–51
- Telephone directory..... 29
- Telephone line cord..... 5, 18
- Telephone number list..... 64
- Thermal head cleaning..... 63
- TONE button..... 26
- Transmission
 - (Manually)..... 7, 31
 - (One-Touch Dial)..... 32
 - (Speed Dial)..... 32
- Transmittable document..... 33, 66
- V** Voice call
 - (Answering)..... 6, 25
 - (Making)..... 6, 24
 - (One-Touch Dial)..... 28
 - (Speed Dial)..... 28
- Voice contact..... 30
- VOLUME button..... 23

Features Summary

Summary of user programmable features

Basic features

Code	Feature & Display	Available settings	Meaning	Page
#01	Setting the date and time SET DATE & TIME	(2 digits for each entry)	mm/dd/yy hh:mm	19
#02	Setting your logo YOUR LOGO	(up to 30 characters)		20
#03	Setting your facsimile telephone number YOUR FAX NO.	(Up to 20 digits)		22
#04	Printing the sending report SENDING REPORT	ERROR	If transmission fails	34
		ON	Activate	
		OFF	Deactivate	
#07	Setting the ring count in the FAX ONLY mode FAX RING COUNT	1, 2, 3, 4	1 to 4 rings	44
#13	Setting the dialling mode DIALING MODE	TONE	Set to TONE.	18
		PULSE	Set to PULSE.	

(The pre-selected setting is in bold type.)

Advanced features

Code	Feature & Display	Available settings	Meaning	Page
#22	Setting the journal report to print automatically AUTO JOURNAL	ON	Activate	35
		OFF	Deactivate	
#23	Sending documents overseas OVERSEAS MODE	ON	Activate	38
		OFF	Deactivate	
#25	Sending a fax at a specified time DELAYED SEND	ON	Activate	36
		OFF	Deactivate	
#30	Setting the silent fax recognition ring count SILENT FAX RING	3, 4, 5, 6, 7, 8, 9	3 to 9 rings	51

(continued)

Features Summary

Advanced features

Code	Feature & Display	Available settings	Meaning	Page
#31	Setting the ring pattern detection RING DETECTION	ON	Activate	47
		OFF	Deactivate	
#41	Changing the fax activation code FAX ACTIVATION	ON / CODE=* * * 9	Activate	45
		OFF	Deactivate	
#46	Setting the friendly reception FRIENDLY RCV	ON	Activate	52
		OFF	Deactivate	
#49	Setting the auto disconnection AUTO DISCONNECT	ON / CODE= * 0	Activate	53
		OFF	Deactivate	
#58	Setting the original mode ORIGINAL	NORMAL	Used for normal writing.	65
		LIGHT	Used for faint writing.	
		DARKER	Used for dark writing.	
#70	Signaling your pager when your unit receives a fax FAX PAGER CALL	ON	Activate	54
		OFF	Deactivate	
#76	Setting the connecting tone CONNECTING TONE	ON	Activate	39
		OFF	Deactivate	
#77	Changing the AUTO ANSWER setting AUTO ANSWER	FAX ONLY	Facsimile only mode	50
		TEL/FAX	Telephone/Facsimile mode	
#78	Setting the TEL/FAX delayed ring count TEL/FAX RING	1, 2, 3, 4	1 to 4 rings	51
#80	Resetting the advanced features SET DEFAULT	YES	Reset	65
		NO	Will not reset.	

(The pre-selected setting is in bold type.)